

54AC191

Up/Down Counter with Preset and Ripple Clock

General Description

The 'AC191 is a reversible modulo 16 binary counter. It features synchronous counting and asynchronous presetting. The preset feature allows the 'AC191 to be used in programmable dividers. The Count Enable input, the Terminal Count output and the Ripple Clock output make possible a variety of methods of implementing multistage counters. In the counting modes, state changes are initiated by the rising edge of the clock.

Features

- I_{CC} reduced by 50%
- High speed — 133 MHz typical count frequency
- Synchronous counting
- Asynchronous parallel load
- Cascadable
- Outputs source/sink 24 mA
- Standard Military Drawing (SMD) — 'AC191: 5962-89749

Logic Symbols

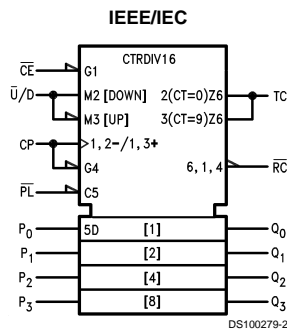
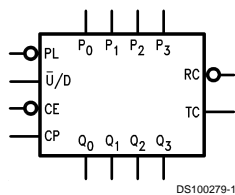

Connection Diagrams

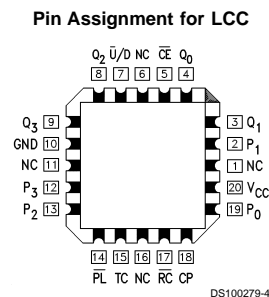
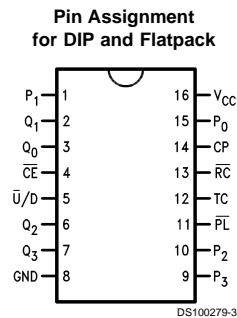

Pin Names	Description
CE	Count Enable Input
CP	Clock Pulse Input
P ₀ –P ₃	Parallel Data Inputs
PL	Asynchronous Parallel Load Input
U/D	Up/Down Count Control Input
Q ₀ –Q ₃	Flip-Flop Outputs
RC	Ripple Clock Output
TC	Terminal Count Output

FACT™ is a trademark of Fairchild Semiconductor Corporation.

Functional Description

The 'AC191 is a synchronous up/down counter. The 'AC191 is organized as a 4-bit binary counter. It contains four edge-triggered flip-flops with internal gating and steering logic to provide individual preset, count-up and count-down operations.

Each circuit has an asynchronous parallel load capability permitting the counter to be preset to any desired number. When the Parallel Load (\overline{PL}) input is LOW, information present on the Parallel Load inputs (P_0 – P_3) is loaded into the counter and appears on the Q outputs. This operation overrides the counting functions, as indicated in the Mode Select Table.

A HIGH signal on the \overline{CE} input inhibits counting. When \overline{CE} is LOW, internal state changes are initiated synchronously by the LOW-to-HIGH transition of the clock input. The direction of counting is determined by the $\overline{U/D}$ input signal, as indicated in the Mode Select Table. \overline{CE} and $\overline{U/D}$ can be changed with the clock in either state, provided only that the recommended setup and hold times are observed.

Two types of outputs are provided as overflow/underflow indicators. The terminal count (TC) output is normally LOW. It goes HIGH when the circuits reach zero in the count down mode or 15 in the count up mode. The TC output will then remain HIGH until a state change occurs, whether by counting or presetting or until $\overline{U/D}$ is changed. The TC output should not be used as a clock signal because it is subject to decoding spikes.

The TC signal is also used internally to enable the Ripple Clock (\overline{RC}) output. The \overline{RC} output is normally HIGH. When \overline{CE} is LOW and TC is HIGH, \overline{RC} output will go LOW when the clock next goes LOW and will stay LOW until the clock goes HIGH again. This feature simplifies the design of multistage counters, as indicated in *Figure 1* and *Figure 2*. In *Figure 1*, each \overline{RC} output is used as the clock input for the next higher stage. This configuration is particularly advantageous when the clock source has a limited drive capability, since it drives only the first stage. To prevent counting in all stages it is only necessary to inhibit the first stage, since a HIGH signal on \overline{CE} inhibits the \overline{RC} output pulse, as indicated in the \overline{RC} Truth Table. A disadvantage of this configuration, in some applications, is the timing skew between state changes in the first and last stages. This represents the cumulative delay of the clock as it ripples through the preceding stages.

A method of causing state changes to occur simultaneously in all stages is shown in *Figure 2*. All clock inputs are driven in parallel and the \overline{RC} outputs propagate the carry/borrow signals in ripple fashion. In this configuration the LOW state duration of the clock must be long enough to allow the negative-going edge of the carry/borrow signal to ripple through to the last stage before the clock goes HIGH. There is no such restriction on the HIGH state duration of the clock, since the \overline{RC} output of any device goes HIGH shortly after its CP input goes HIGH.

The configuration shown in *Figure 3* avoids ripple delays and their associated restrictions. The \overline{CE} input for a given stage is formed by combining the TC signals from all the preceding stages. Note that in order to inhibit counting an enable signal must be included in each carry gate. The simple inhibit scheme of *Figure 1* and *Figure 2* doesn't apply, because the TC output of a given stage is not affected by its own \overline{CE} .

Mode Select Table

Inputs				Mode
\overline{PL}	\overline{CE}	$\overline{U/D}$	CP	
H	L	L	↗	Count Up
H	L	H	↘	Count Down
L	X	X	X	Preset (Asyn.)
H	H	X	X	No Change (Hold)

\overline{RC} Truth Table

Inputs				Outputs
\overline{PL}	\overline{CE}	TC*	CP	\overline{RC}
H	L	H	↘	↘
H	H	X	X	H
H	X	L	X	H
L	X	X	X	H

*TC is generated internally
H = HIGH Voltage Level
L = LOW Voltage Level
X = Immaterial
↗ = LOW-to-HIGH Transition

Functional Description (Continued)

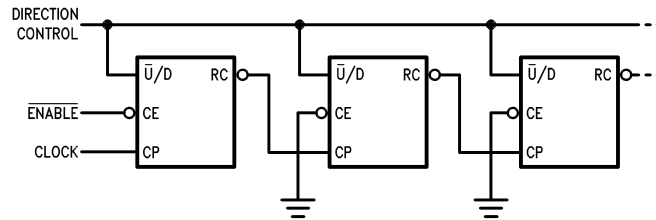

DS100279-7

FIGURE 1. N-Stage Counter Using Ripple Clock

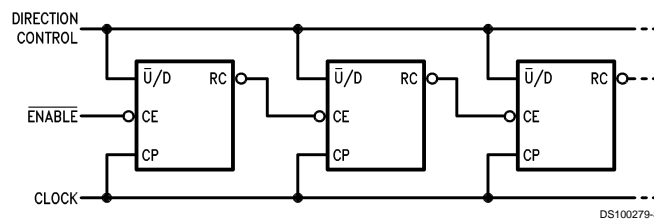

DS100279-8

FIGURE 2. Synchronous N-Stage Counter Using Ripple Carry/Borrow

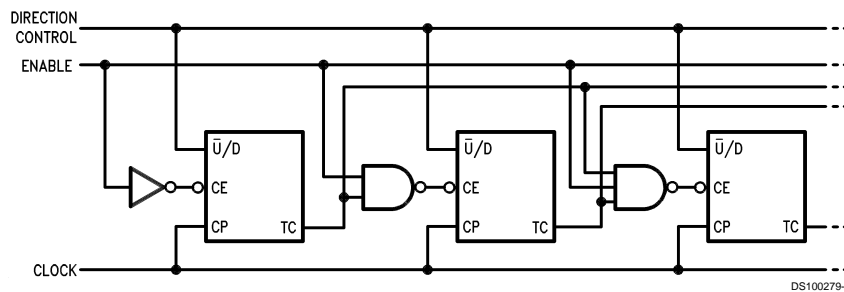

DS100279-9

FIGURE 3. Synchronous N-Stage Counter with Parallel Gated Carry/Borrow

State Diagram

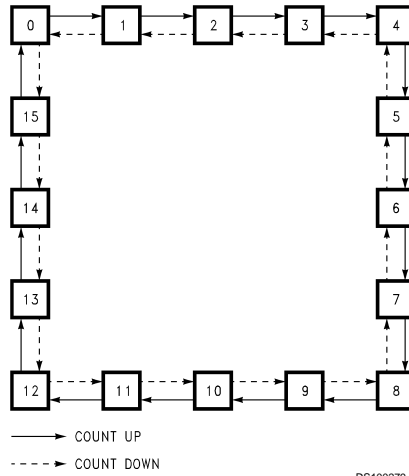

DS100279-5

Logic Diagram

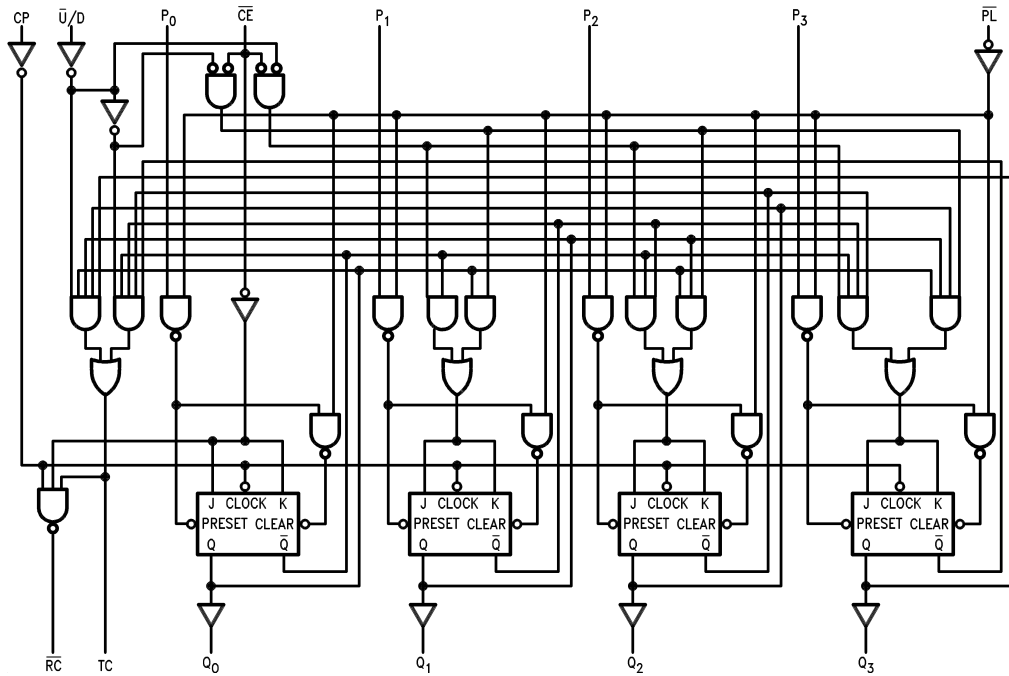

DS100279-6

Please note that this diagram is provided only for the understanding of logic operations and should not be used to estimate propagation delays.

Absolute Maximum Ratings (Note 1)

If Military/Aerospace specified devices are required, please contact the National Semiconductor Sales Office/Distributors for availability and specifications.

Supply Voltage (V_{CC})	-0.5V to +7.0V
DC Input Diode Current (I_{IK})	
$V_I = -0.5V$	-20 mA
$V_I = V_{CC} + 0.5V$	+20 mA
DC Input Voltage (V_I)	-0.5V to $V_{CC} + 0.5V$
DC Output Diode Current (I_{OK})	
$V_O = -0.5V$	-20 mA
$V_O = V_{CC} + 0.5V$	+20 mA
DC Output Voltage (V_O)	-0.5V to $V_{CC} + 0.5V$
DC Output Source or Sink Current (I_O)	±50 mA
DC V_{CC} or Ground Current per Output Pin (I_{CC} or I_{GND})	±50 mA
Storage Temperature (T_{STG})	-65°C to +150°C

Junction Temperature (T_J)

CDIP

175°C

Recommended Operating Conditions

Supply Voltage (V_{CC})	2.0V to 6.0V
Input Voltage (V_I)	0V to V_{CC}
Output Voltage (V_O)	0V to V_{CC}
Operating Temperature (T_A)	
54AC	-55°C to +125°C
Minimum Input Edge Rate ($\Delta V/\Delta t$) 'AC Devices	
V_{IN} from 30% to 70% of V_{CC}	
V_{CC} @ 3.3V 4.5V, 5.5V	125 mV/ns

Note 1: Absolute maximum ratings are those values beyond which damage to the device may occur. The databook specifications should be met, without exception, to ensure that the system design is reliable over its power supply, temperature, output/input loading variables. National does not recommend operation of FACT™ circuits outside databook specifications.

DC Characteristics for 'AC Family Devices

Symbol	Parameter	V_{CC} (V)	54AC		Units	Conditions
			$T_A = -55^\circ\text{C to } +125^\circ\text{C}$			
			Guaranteed Limits			
V_{IH}	Minimum High Level Input Voltage	3.0	2.1	V	$V_{OUT} = 0.1V$ or $V_{CC} - 0.1V$	
		4.5	3.15			
		5.5	3.85			
V_{IL}	Maximum Low Level Input Voltage	3.0	0.9	V	$V_{OUT} = 0.1V$ or $V_{CC} - 0.1V$	
		4.5	1.35			
		5.5	1.65			
V_{OH}	Minimum High Level Output Voltage	3.0	2.9	V	$I_{OUT} = -50 \mu A$	
		4.5	4.4			
		5.5	5.4			
			3.0	2.4	V	(Note 2) $V_{IN} = V_{IL}$ or V_{IH} -12 mA $I_{OH} -24 \text{ mA}$ -24 mA
			4.5	3.7		
			5.5	4.7		
V_{OL}	Maximum Low Level Output Voltage	3.0	0.1	V	$I_{OUT} = 50 \mu A$	
		4.5	0.1			
		5.5	0.1			
			3.0	0.50	V	(Note 2) $V_{IN} = V_{IL}$ or V_{IH} 12 mA $I_{OL} 24 \text{ mA}$ 24 mA
			4.5	0.50		
			5.5	0.50		
I_{IN}	Maximum Input Leakage Current	5.5	±1.0	μA	$V_I = V_{CC}, GND$	
I_{OLD}	(Note 3) Minimum Dynamic	5.5	50	mA	$V_{OLD} = 1.65V \text{ Max}$	
I_{OHD}	Output Current	5.5	-50	mA	$V_{OHD} = 3.85V \text{ Min}$	
I_{CC}	Maximum Quiescent Supply Current	5.5	80.0	μA	$V_{IN} = V_{CC}$ or GND	

DC Characteristics for 'AC Family Devices (Continued)

Note 2: All outputs loaded; thresholds on input associated with output under test.

Note 3: Maximum test duration 2.0 ms, one output loaded at a time.

Note 4: I_{IN} and I_{CC} @ 3.0V are guaranteed to be less than or equal to the respective limit @ 5.5V V_{CC} .

I_{CC} for 54AC @ 25°C is identical to 74AC @ 25°C.

AC Electrical Characteristics

Symbol	Parameter	V_{CC} (V) (Note 5)	54AC		Units	Fig. No.
			$T_A = -55^\circ\text{C}$ to $+125^\circ\text{C}$ $C_L = 50\text{ pF}$			
			Min	Max		
f_{max}	Maximum Count Frequency	3.3	55		MHz	
		5.0	80			
t_{PLH}	Propagation Delay CP to Q_n	3.3	1.0	16.5	ns	
		5.0	1.0	12.0		
t_{PHL}	Propagation Delay CP to Q_n	3.3	1.0	16.0	ns	
		5.0	1.0	12.0		
t_{PLH}	Propagation Delay CP to TC	3.3	1.0	19.5	ns	
		5.0	1.0	14.0		
t_{PHL}	Propagation Delay CP to TC	3.3	1.0	19.0	ns	
		5.0	1.0	14.5		
t_{PLH}	Propagation Delay CP to \overline{RC}	3.3	1.0	14.0	ns	
		5.0	1.0	10.5		
t_{PHL}	Propagation Delay CP to \overline{RC}	3.3	1.0	12.5	ns	
		5.0	1.0	9.5		
t_{PLH}	Propagation Delay \overline{CE} to \overline{RC}	3.3	1.0	14.0	ns	
		5.0	1.0	10.0		
t_{PHL}	Propagation Delay \overline{CE} to \overline{RC}	3.3	1.0	12.5	ns	
		5.0	1.0	9.5		
t_{PLH}	Propagation Delay $\overline{U/D}$ to \overline{RC}	3.3	1.0	14.5	ns	
		5.0	1.0	11.0		
t_{PHL}	Propagation Delay $\overline{U/D}$ to \overline{RC}	3.3	1.0	15.0	ns	
		5.0	1.0	11.0		
t_{PLH}	Propagation Delay $\overline{U/D}$ to TC	3.3	1.0	14.0	ns	
		5.0	1.0	10.5		
t_{PHL}	Propagation Delay $\overline{U/D}$ to TC	3.3	1.0	13.5	ns	
		5.0	1.0	10.0		
t_{PLH}	Propagation Delay P_n to Q_n	3.3	1.0	16.5	ns	
		5.0	1.0	11.5		
t_{PHL}	Propagation Delay P_n to Q_n	3.3	1.0	15.5	ns	
		5.0	1.0	10.5		
t_{PLH}	Propagation Delay \overline{PL} to Q_n	3.3	1.0	18.0	ns	
		5.0	1.0	12.5		
t_{PHL}	Propagation Delay \overline{PL} to Q_n	3.3	1.0	15.5	ns	
		5.0	1.0	11.5		

Note 5: Voltage Range 3.3 is 3.3V $\pm 0.3V$

Voltage Range 5.0 is 5.0V $\pm 0.5V$

AC Operating Requirements

Symbol	Parameter	V _{CC} (V) (Note 6)	54AC	Units	Fig. No.
			T _A = -55°C to +125°C C _L = 50 pF		
			Guaranteed Minimum		
t _s	Setup Time, HIGH or LOW P _n to \overline{PL}	3.3	4.0	ns	
		5.0	3.0		
t _h	Hold Time, HIGH or LOW P _n to \overline{PL}	3.3	1.5	ns	
		5.0	2.0		
t _s	Setup Time, LOW \overline{CE} to CP	3.3	9.0	ns	
		5.0	6.0		
t _h	Hold Time, LOW \overline{CE} to CP	3.3	0	ns	
		5.0	0.5		
t _s	Setup Time, HIGH or LOW $\overline{U/D}$ to CP	3.3	10.5	ns	
		5.0	7.5		
t _h	Hold Time, HIGH or LOW $\overline{U/D}$ to CP	3.3	0	ns	
		5.0	1.0		
t _w	\overline{PL} Pulse Width, LOW	3.3	5.0	ns	
		5.0	5.0		
t _w	CP Pulse Width, LOW	3.3	6.0	ns	
		5.0	6.0		
t _{rec}	Recovery Time \overline{PL} to CP	3.3	1.5	ns	
		5.0	1.0		

Note 6: Voltage Range 3.3 is 3.3V ±0.3V
Voltage Range 5.0 is 5.0V ±0.5V

Capacitance

Symbol	Parameter	Typ	Units	Conditions
C _{IN}	Input Capacitance	4.5	pF	V _{CC} = OPEN
C _{PD}	Power Dissipation Capacitance	75.0	pF	V _{CC} = 5.0V

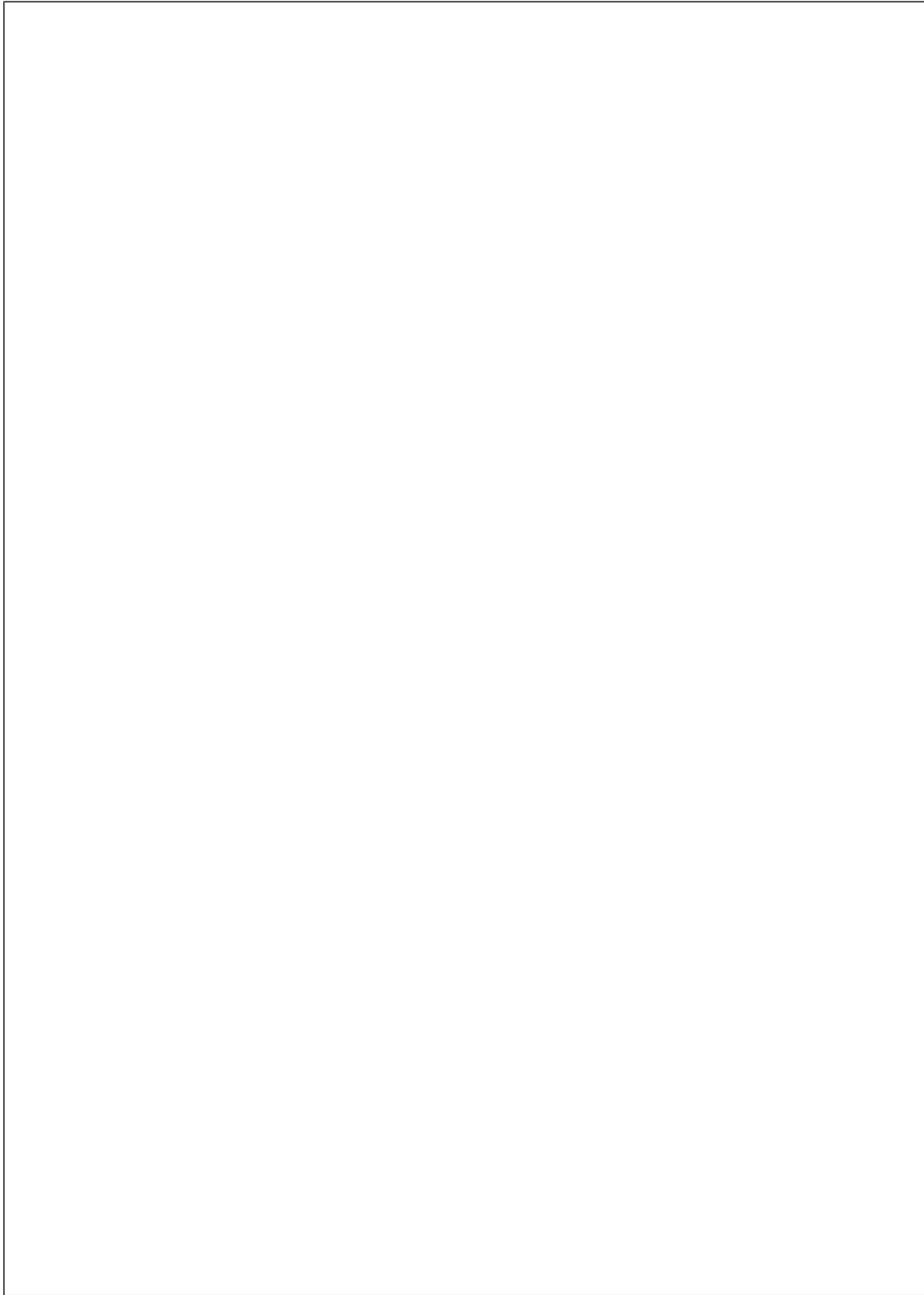

Physical Dimensions inches (millimeters) unless otherwise noted

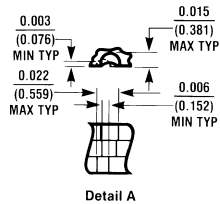
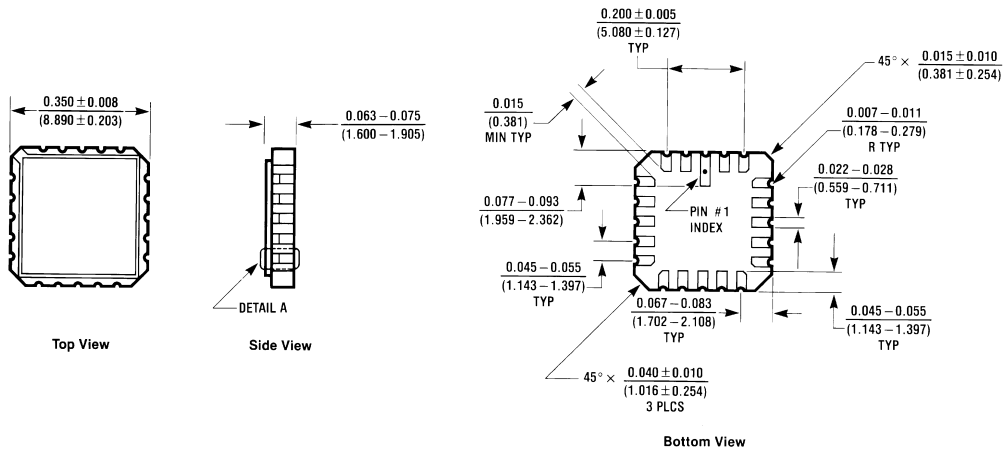

20 Terminal Ceramic Leadless Chip Carrier (L)
 NS Package Number E20A

E20A (REV D)

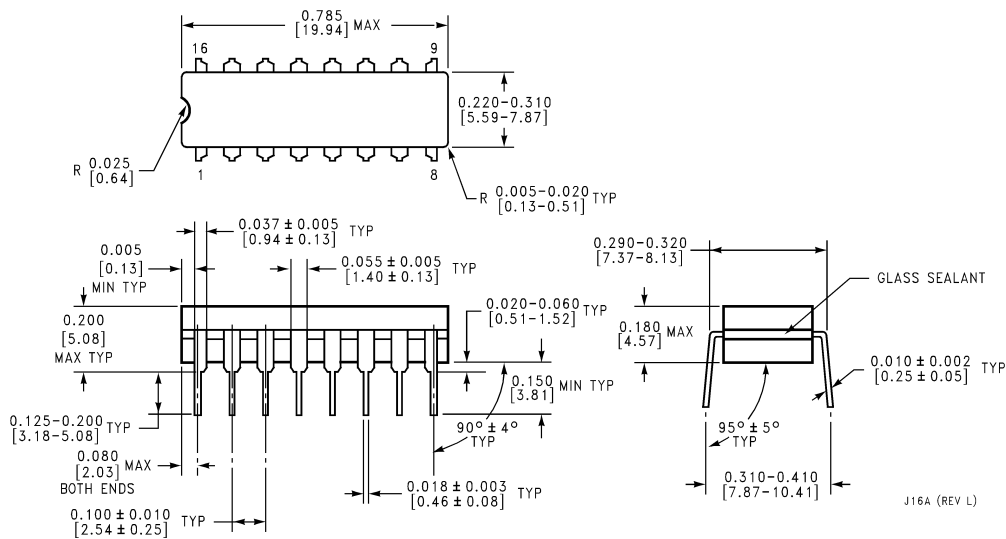

16 Lead Ceramic Dual-In-Line Package (D)
 NS Package Number J16A

J16A (REV L)

Physical Dimensions inches (millimeters) unless otherwise noted (Continued)

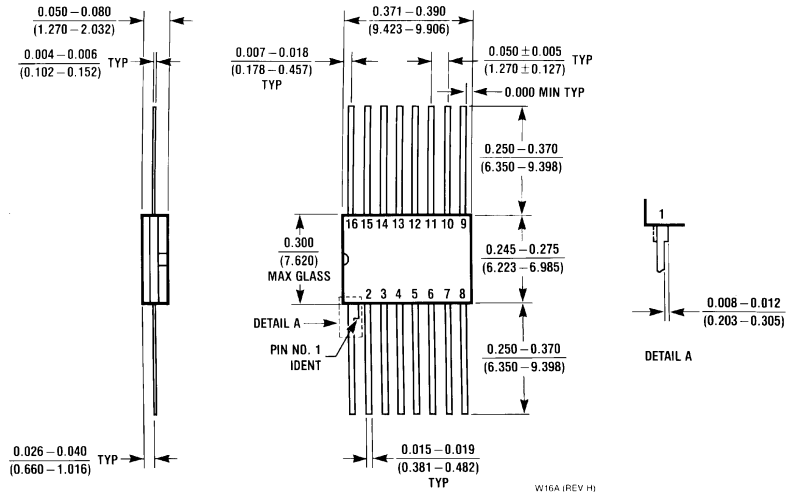

**16 Lead Ceramic Flatpak (F)
NS Package Number W16A**

LIFE SUPPORT POLICY

NATIONAL'S PRODUCTS ARE NOT AUTHORIZED FOR USE AS CRITICAL COMPONENTS IN LIFE SUPPORT DEVICES OR SYSTEMS WITHOUT THE EXPRESS WRITTEN APPROVAL OF THE PRESIDENT OF NATIONAL SEMICONDUCTOR CORPORATION. As used herein:

1. Life support devices or systems are devices or systems which, (a) are intended for surgical implant into the body, or (b) support or sustain life, and whose failure to perform when properly used in accordance with instructions for use provided in the labeling, can be reasonably expected to result in a significant injury to the user.
2. A critical component in any component of a life support device or system whose failure to perform can be reasonably expected to cause the failure of the life support device or system, or to affect its safety or effectiveness.



National Semiconductor Corporation
Americas
Tel: 1-800-272-9959
Fax: 1-800-737-7018
Email: support@nsc.com

National Semiconductor Europe
Fax: +49 (0) 1 80-530 85 86
Email: europe.support@nsc.com
Deutsch Tel: +49 (0) 1 80-530 85 85
English Tel: +49 (0) 1 80-532 78 32
Français Tel: +49 (0) 1 80-532 93 58
Italiano Tel: +49 (0) 1 80-534 16 80

National Semiconductor Asia Pacific Customer Response Group
Tel: 65-2544466
Fax: 65-2504466
Email: sea.support@nsc.com

National Semiconductor Japan Ltd.
Tel: 81-3-5620-6175
Fax: 81-3-5620-6179

www.national.com

National does not assume any responsibility for use of any circuitry described, no circuit patent licenses are implied and National reserves the right at any time without notice to change said circuitry and specifications.