

### 1. PART NO. EXPRESSION :

S D C 0 7 0 3 - 1 0 1 M F  
 (a) (b) (c) (d)(e)

- (a) Series code
- (b) Dimension code
- (c) Inductance code : 101 = 100uH
- (d) Tolerance code : M = ±20%
- (e) F : Lead Free

### 2. CONFIGURATION & DIMENSIONS :

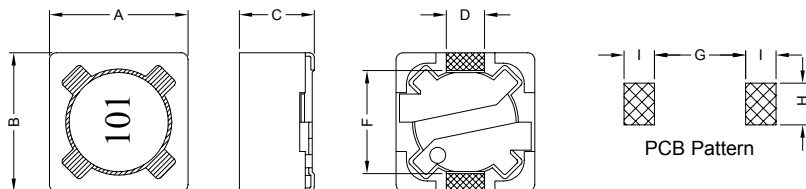

Unit:m/m

A	B	C	D	F	G	H	I
7.30±0.20	7.30±0.20	3.40 Max.	1.80 Ref.	5.00 Ref.	4.8 Ref.	2.2 Ref.	1.6 Ref.

### 3. SCHEMATIC :

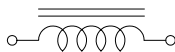

### 4. MATERIALS :

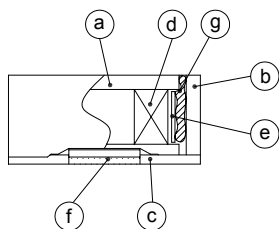

- (a) Core : DR Ferrite Core
- (b) Core : RI Ferrite Core
- (c) Base : LCP
- (d) Wire : Enamelled Copper Wire
- (e) Tape : Mylar Tape
- (f) Terminal : Tinned Copper Plate
- (g) Adhesive : Epoxy

### 5. GENERAL SPECIFICATION :

- a) Temp. rise : 40°C Max.
- b) Rated current : Base on temp. rise &  $\Delta L/L0A = 25\%$  Max.
- c) Operating temp. : -20°C to +80°C



**RoHS Compliant**

NOTE : Specifications subject to change without notice. Please check our website for latest information.

05.05.2008



**SUPERWORLD ELECTRONICS (S) PTE LTD**

## 6. ELECTRICAL CHARACTERISTICS :

Part No.	Inductance ( $\mu$ H)	Test Frequency	RDC ( $\Omega$ ) Max.	IDC (A) Max.
SDC0703-100MF	10 $\pm$ 20%	1KHz / 0.25V	0.072	1.68
SDC0703-120MF	12 $\pm$ 20%	1KHz / 0.25V	0.098	1.52
SDC0703-150MF	15 $\pm$ 20%	1KHz / 0.25V	0.130	1.33
SDC0703-180MF	18 $\pm$ 20%	1KHz / 0.25V	0.140	1.20
SDC0703-220MF	22 $\pm$ 20%	1KHz / 0.25V	0.190	1.07
SDC0703-270MF	27 $\pm$ 20%	1KHz / 0.25V	0.210	0.96
SDC0703-330MF	33 $\pm$ 20%	1KHz / 0.25V	0.240	0.91
SDC0703-390MF	39 $\pm$ 20%	1KHz / 0.25V	0.320	0.77
SDC0703-470MF	47 $\pm$ 20%	1KHz / 0.25V	0.360	0.76
SDC0703-560MF	56 $\pm$ 20%	1KHz / 0.25V	0.470	0.68
SDC0703-680MF	68 $\pm$ 20%	1KHz / 0.25V	0.520	0.61
SDC0703-820MF	82 $\pm$ 20%	1KHz / 0.25V	0.690	0.57
SDC0703-101MF	100 $\pm$ 20%	1KHz / 0.25V	0.790	0.50
SDC0703-121MF	120 $\pm$ 20%	1KHz / 0.25V	0.890	0.49
SDC0703-151MF	150 $\pm$ 20%	1KHz / 0.25V	1.270	0.43
SDC0703-181MF	180 $\pm$ 20%	1KHz / 0.25V	1.450	0.39
SDC0703-221MF	220 $\pm$ 20%	1KHz / 0.25V	1.650	0.35
SDC0703-271MF	270 $\pm$ 20%	1KHz / 0.25V	2.310	0.32
SDC0703-331MF	330 $\pm$ 20%	1KHz / 0.25V	2.620	0.28
SDC0703-391MF	390 $\pm$ 20%	1KHz / 0.25V	2.940	0.26
SDC0703-471MF	470 $\pm$ 20%	1KHz / 0.25V	4.180	0.24
SDC0703-561MF	560 $\pm$ 20%	1KHz / 0.25V	4.670	0.22
SDC0703-681MF	680 $\pm$ 20%	1KHz / 0.25V	5.730	0.19
SDC0703-821MF	820 $\pm$ 20%	1KHz / 0.25V	6.540	0.18
SDC0703-102MF	1000 $\pm$ 20%	1KHz / 0.25V	9.440	0.16



RoHS Compliant

NOTE : Specifications subject to change without notice. Please check our website for latest information.

05.05.2008



SUPERWORLD ELECTRONICS (S) PTE LTD

PG. 2

## 7. PACKAGING INFORMATION : ( Unit : mm )

### 7-1. Reel & Tape Dimension

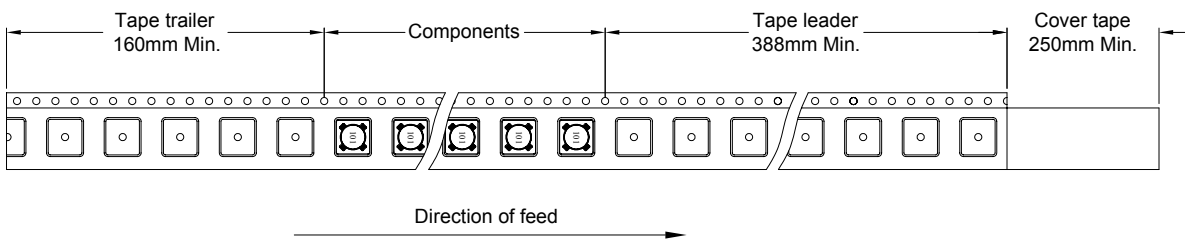
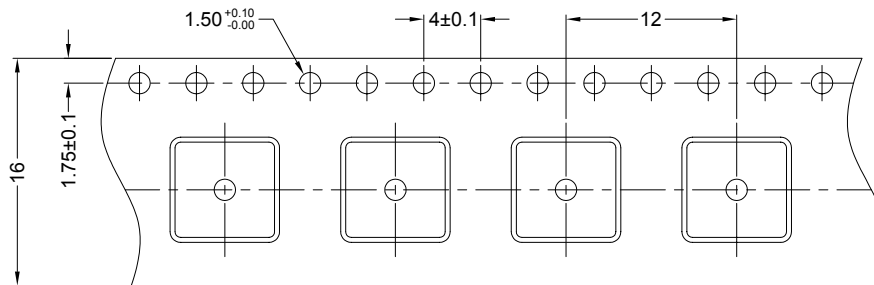
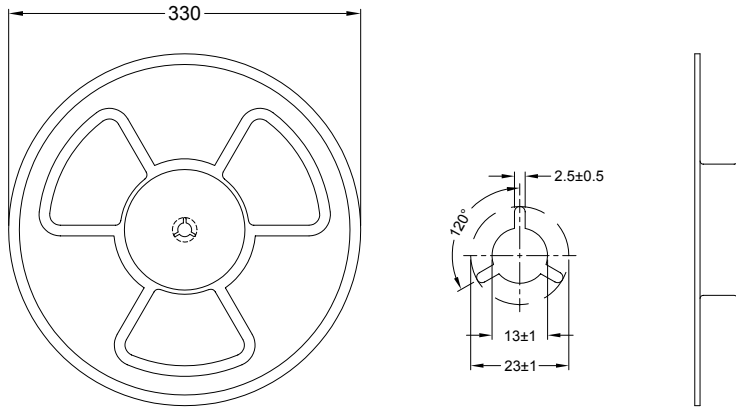

### 7-2. Quantity & G.W. per package

SERIES	INNER : REEL			OUTER : CARTON		
	Q'TY (PCS)	G.W. (Kg)	STYLE	Q'TY (PCS)	G.W. (Kg)	SIZE (cm)
SDC0703	1000	1.0	13-16	16000	20	36 x 36 x 40



**RoHS Compliant**

NOTE : Specifications subject to change without notice. Please check our website for latest information.

05.05.2008

### 7-3. Tearing Off Force

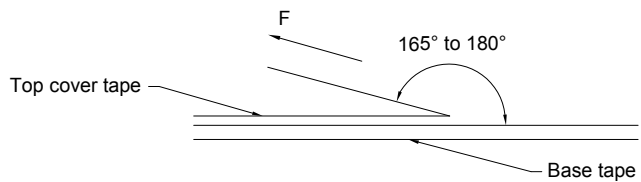

The force for tearing off cover tape is 10 to 60 grams in the arrow direction.



**RoHS Compliant**

*NOTE : Specifications subject to change without notice. Please check our website for latest information.*

05.05.2008



**SUPERWORLD ELECTRONICS (S) PTE LTD**

PG. 4