

BCM857BV; BCM857BS; BCM857DS

PNP/PNP matched double transistors

Rev. 05 — 27 June 2006

Product data sheet

1. Product profile

1.1 General description

PNP/PNP matched double transistors in small Surface-Mounted Device (SMD) plastic packages. The transistors are fully isolated internally.

Table 1. Product overview

Type number	Package		NPN/NPN complement	Matched version of
	Philips	JEITA		
BCM857BV	SOT666	-	BCM847BV	BC857BV
BCM857BS	SOT363	SC-88	BCM847BS	BC857BS
BCM857DS	SOT457	SC-74	BCM847DS	-

1.2 Features

- Current gain matching
- Base-emitter voltage matching
- Drop-in replacement for standard double transistors

1.3 Applications

- Current mirror
- Differential amplifier

1.4 Quick reference data

Table 2. Quick reference data

Symbol	Parameter	Conditions	Min	Typ	Max	Unit
Per transistor						
V_{CEO}	collector-emitter voltage	open base	-	-	-45	V
I_C	collector current		-	-	-100	mA
h_{FE}	DC current gain	$V_{CE} = -5\text{ V};$ $I_C = -2\text{ mA}$	200	290	450	

PHILIPS

Table 2. Quick reference data ...continued

Symbol	Parameter	Conditions	Min	Typ	Max	Unit
Per device						
h_{FE1}/h_{FE2}	h_{FE} matching	$V_{CE} = -5\text{ V};$ $I_C = -2\text{ mA}$	[1] 0.9	1	-	
$V_{BE1}-V_{BE2}$	V_{BE} matching	$V_{CE} = -5\text{ V};$ $I_C = -2\text{ mA}$	[2] -	-	2	mV

[1] The smaller of the two values is taken as the numerator.

[2] The smaller of the two values is subtracted from the larger value.

2. Pinning information

Table 3. Pinning

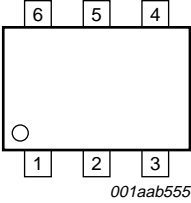
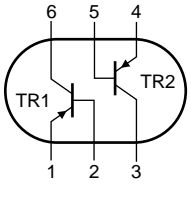
Pin	Description	Simplified outline	Symbol
1	emitter TR1	 <p>001aab555</p>	 <p>sym018</p>
2	base TR1		
3	collector TR2		
4	emitter TR2		
5	base TR2		
6	collector TR1		

3. Ordering information

Table 4. Ordering information

Type number	Package		Version
	Name	Description	
BCM857BV	-	plastic surface-mounted package; 6 leads	SOT666
BCM857BS	SC-88	plastic surface-mounted package; 6 leads	SOT363
BCM857DS	SC-74	plastic surface-mounted package (TSOP6); 6 leads	SOT457

4. Marking

Table 5. Marking codes

Type number	Marking code ^[1]
BCM857BV	3B
BCM857BS	A9*
BCM857DS	R8

[1] * = -: made in Hong Kong
 * = p: made in Hong Kong
 * = t: made in Malaysia
 * = W: made in China

5. Limiting values

Table 6. Limiting values

In accordance with the Absolute Maximum Rating System (IEC 60134).

Symbol	Parameter	Conditions	Min	Max	Unit	
Per transistor						
V_{CBO}	collector-base voltage	open emitter	-	-50	V	
V_{CEO}	collector-emitter voltage	open base	-	-45	V	
V_{EBO}	emitter-base voltage	open collector	-	-5	V	
I_C	collector current		-	-100	mA	
I_{CM}	peak collector current	single pulse; $t_p \leq 1$ ms	-	-200	mA	
P_{tot}	total power dissipation	$T_{amb} \leq 25$ °C				
	SOT666		[1][2]	-	200	mW
	SOT363		[1]	-	200	mW
	SOT457		[1]	-	250	mW
Per device						
P_{tot}	total power dissipation	$T_{amb} \leq 25$ °C				
	SOT666		[1][2]	-	300	mW
	SOT363		[1]	-	300	mW
	SOT457		[1]	-	380	mW
T_j	junction temperature		-	150	°C	
T_{amb}	ambient temperature		-65	+150	°C	
T_{stg}	storage temperature		-65	+150	°C	

[1] Device mounted on an FR4 Printed-Circuit Board (PCB), single-sided copper, tin-plated and standard footprint.

[2] Reflow soldering is the only recommended soldering method.

6. Thermal characteristics

Table 7. Thermal characteristics

Symbol	Parameter	Conditions	Min	Typ	Max	Unit	
Per transistor							
$R_{th(j-a)}$	thermal resistance from junction to ambient	in free air					
	SOT666		[1][2]	-	-	625	K/W
	SOT363		[1]	-	-	625	K/W
	SOT457		[1]	-	-	500	K/W

Table 7. Thermal characteristics ...continued

Symbol	Parameter	Conditions	Min	Typ	Max	Unit
Per device						
$R_{th(j-a)}$	thermal resistance from junction to ambient	in free air				
	SOT666		[1][2]	-	416	K/W
	SOT363		[1]	-	416	K/W
	SOT457		[1]	-	328	K/W

[1] Device mounted on an FR4 PCB, single-sided copper, tin-plated and standard footprint.

[2] Reflow soldering is the only recommended soldering method.

7. Characteristics

Table 8. Characteristics

$T_{amb} = 25\text{ }^{\circ}\text{C}$ unless otherwise specified.

Symbol	Parameter	Conditions	Min	Typ	Max	Unit	
Per transistor							
I_{CBO}	collector-base cut-off current	$V_{CB} = -30\text{ V};$ $I_E = 0\text{ A}$	-	-	-15	nA	
		$V_{CB} = -30\text{ V};$ $I_E = 0\text{ A};$ $T_j = 150\text{ }^{\circ}\text{C}$	-	-	-5	μA	
I_{EBO}	emitter-base cut-off current	$V_{EB} = -5\text{ V};$ $I_C = 0\text{ A}$	-	-	-100	nA	
h_{FE}	DC current gain	$V_{CE} = -5\text{ V};$ $I_C = -10\text{ }\mu\text{A}$	-	250	-		
		$V_{CE} = -5\text{ V};$ $I_C = -2\text{ mA}$	200	290	450		
V_{CEsat}	collector-emitter saturation voltage	$I_C = -10\text{ mA};$ $I_B = -0.5\text{ mA}$	-	-50	-200	mV	
		$I_C = -100\text{ mA};$ $I_B = -5\text{ mA}$	-	-200	-400	mV	
V_{BEsat}	base-emitter saturation voltage	$I_C = -10\text{ mA};$ $I_B = -0.5\text{ mA}$	[1]	-	-760	mV	
		$I_C = -100\text{ mA};$ $I_B = -5\text{ mA}$	[1]	-	-920	mV	
V_{BE}	base-emitter voltage	$V_{CE} = -5\text{ V};$ $I_C = -2\text{ mA}$	[2]	-600	-650	-700	mV
		$V_{CE} = -5\text{ V};$ $I_C = -10\text{ mA}$	[2]	-	-	-760	mV
C_c	collector capacitance	$V_{CB} = -10\text{ V};$ $I_E = i_e = 0\text{ A};$ $f = 1\text{ MHz}$	-	-	2.2	pF	
C_e	emitter capacitance	$V_{EB} = -0.5\text{ V};$ $I_C = i_c = 0\text{ A};$ $f = 1\text{ MHz}$	-	10	-	pF	

Table 8. Characteristics ...continued $T_{amb} = 25^\circ\text{C}$ unless otherwise specified.

Symbol	Parameter	Conditions	Min	Typ	Max	Unit
f_T	transition frequency	$V_{CE} = -5\text{ V};$ $I_C = -10\text{ mA};$ $f = 100\text{ MHz}$	100	175	-	MHz
NF	noise figure	$V_{CE} = -5\text{ V};$ $I_C = -0.2\text{ mA};$ $R_S = 2\text{ k}\Omega;$ $f = 10\text{ Hz to}$ 15.7 kHz	-	1.6	-	dB
		$V_{CE} = -5\text{ V};$ $I_C = -0.2\text{ mA};$ $R_S = 2\text{ k}\Omega;$ $f = 1\text{ kHz};$ $B = 200\text{ Hz}$	-	3.1	-	dB
Per device						
h_{FE1}/h_{FE2}	h_{FE} matching	$V_{CE} = -5\text{ V};$ $I_C = -2\text{ mA}$	[3] 0.9	1	-	
$V_{BE1}-V_{BE2}$	V_{BE} matching	$V_{CE} = -5\text{ V};$ $I_C = -2\text{ mA}$	[4] -	-	2	mV

[1] V_{BEsat} decreases by about 1.7 mV/K with increasing temperature.[2] V_{BE} decreases by about 2 mV/K with increasing temperature.

[3] The smaller of the two values is taken as the numerator.

[4] The smaller of the two values is subtracted from the larger value.

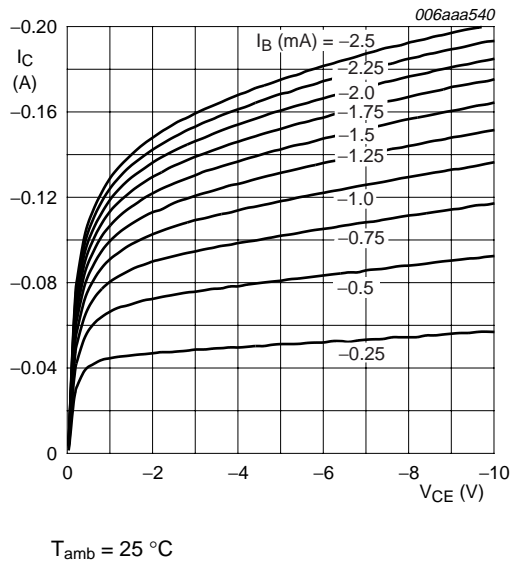

Fig 1. Collector current as a function of collector-emitter voltage; typical values

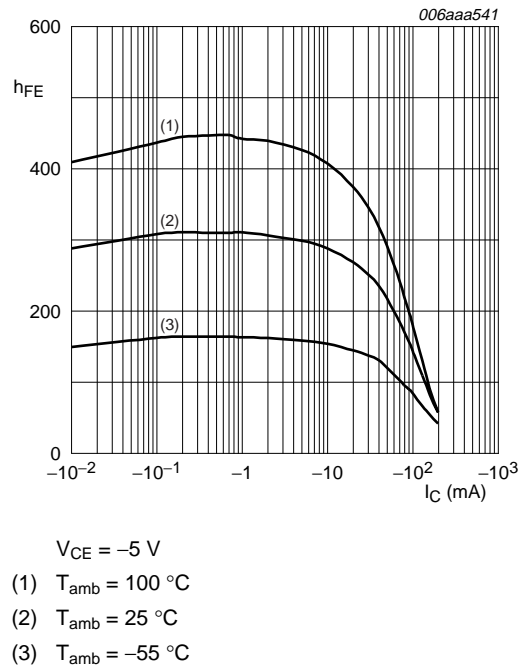

Fig 2. DC current gain as a function of collector current; typical values

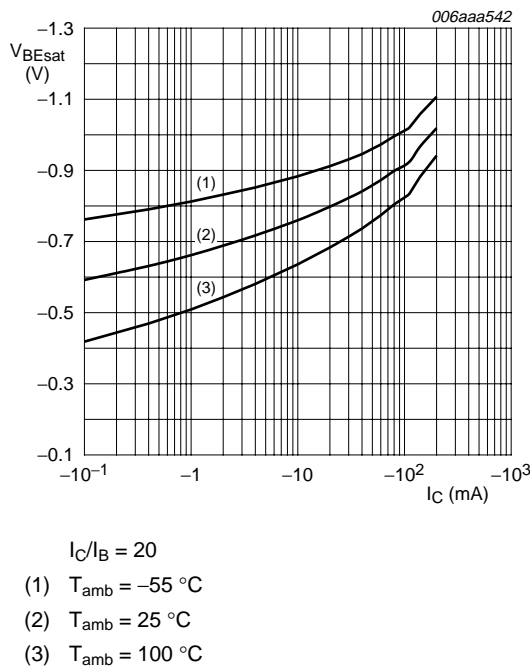

Fig 3. Base-emitter saturation voltage as a function of collector current; typical values

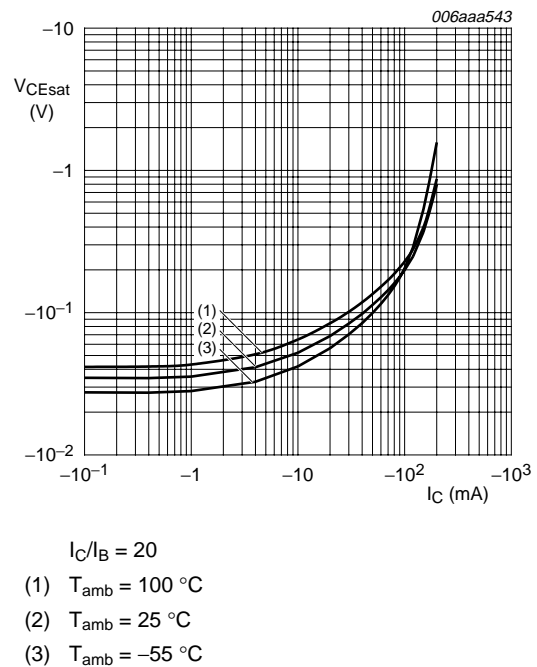
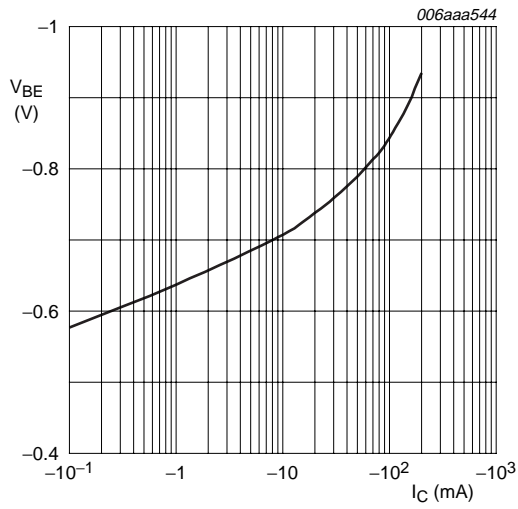
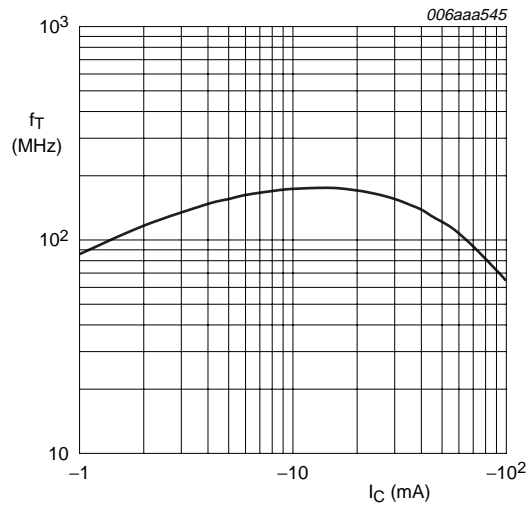

Fig 4. Collector-emitter saturation voltage as a function of collector current; typical values



$V_{CE} = -5$ V; $T_{amb} = 25$ °C

Fig 5. Base-emitter voltage as a function of collector current; typical values



$V_{CE} = -5$ V; $T_{amb} = 25$ °C

Fig 6. Transition frequency as a function of collector current; typical values

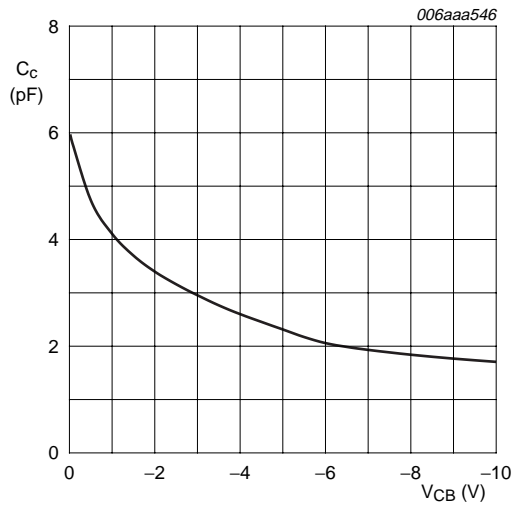

$f = 1$ MHz; $T_{amb} = 25$ °C

Fig 7. Collector capacitance as a function of collector-base voltage; typical values

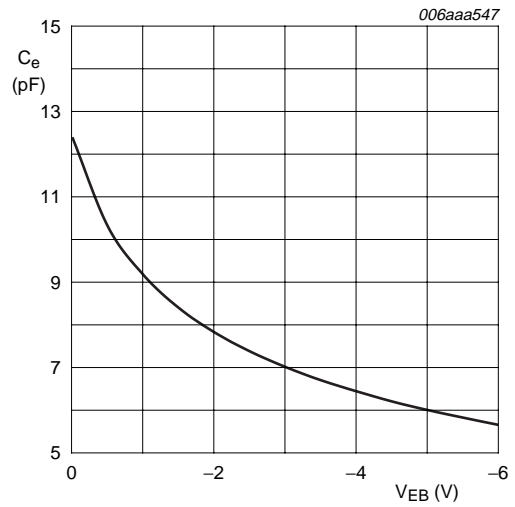

$f = 1$ MHz; $T_{amb} = 25$ °C

Fig 8. Emitter capacitance as a function of emitter-base voltage; typical values

8. Application information

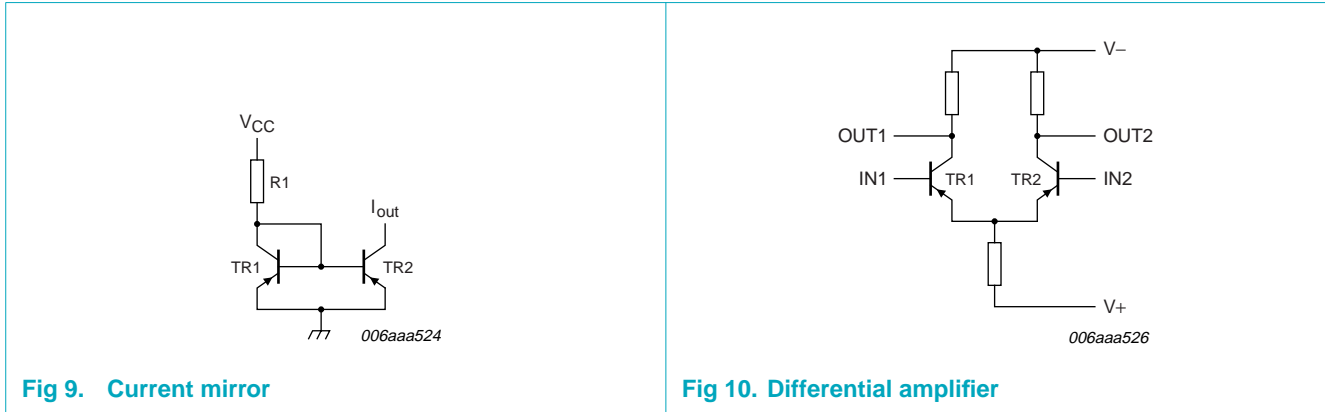

Fig 9. Current mirror

Fig 10. Differential amplifier

9. Package outline

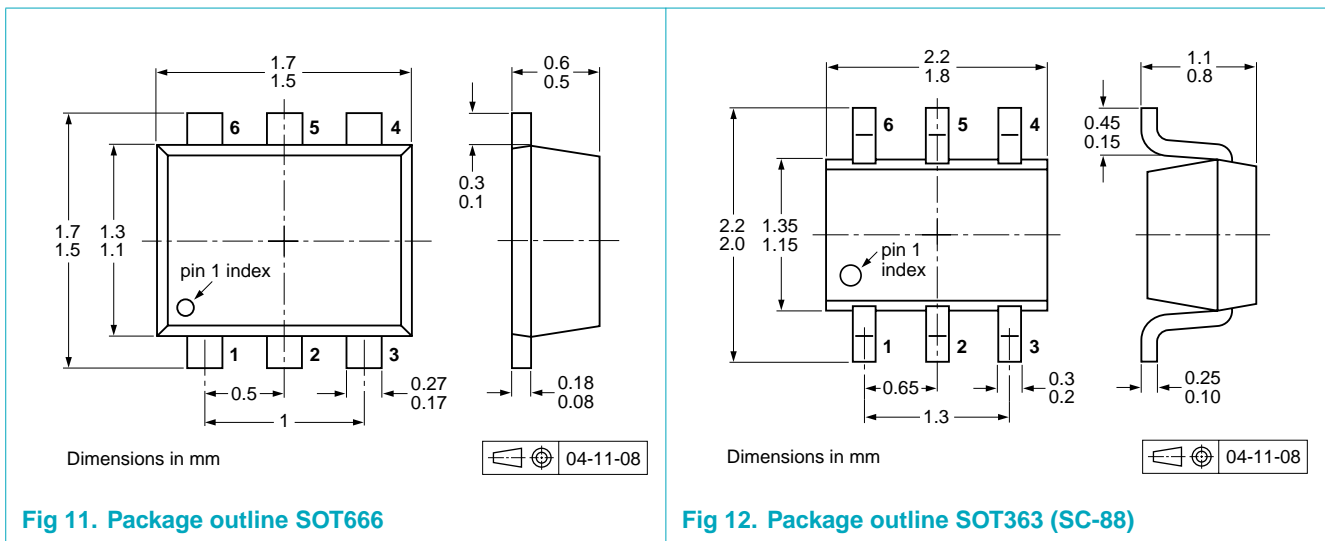

Fig 11. Package outline SOT666

Fig 12. Package outline SOT363 (SC-88)

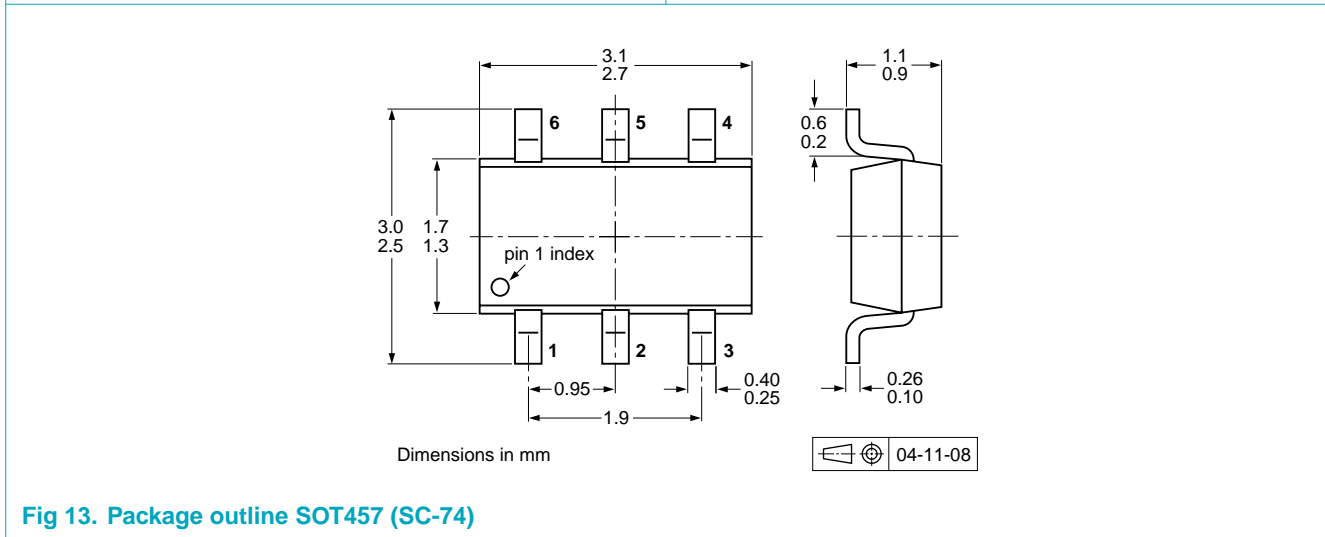

Fig 13. Package outline SOT457 (SC-74)

10. Packing information

Table 9. Packing methods

The indicated -xxx are the last three digits of the 12NC ordering code.^[1]

Type number	Package	Description	Packing quantity			
			3000	4000	8000	10000
BCM857BV	SOT666	2 mm pitch, 8 mm tape and reel	-	-	-315	-
		4 mm pitch, 8 mm tape and reel	-	-115	-	-
BCM857BS	SOT363	4 mm pitch, 8 mm tape and reel; T1 ^[2]	-115	-	-	-135
		4 mm pitch, 8 mm tape and reel; T2 ^[3]	-125	-	-	-165
BCM857DS	SOT457	4 mm pitch, 8 mm tape and reel; T1 ^[2]	-115	-	-	-135
		4 mm pitch, 8 mm tape and reel; T2 ^[3]	-125	-	-	-165

[1] For further information and the availability of packing methods, see [Section 14](#).

[2] T1: normal taping

[3] T2: reverse taping

11. Soldering

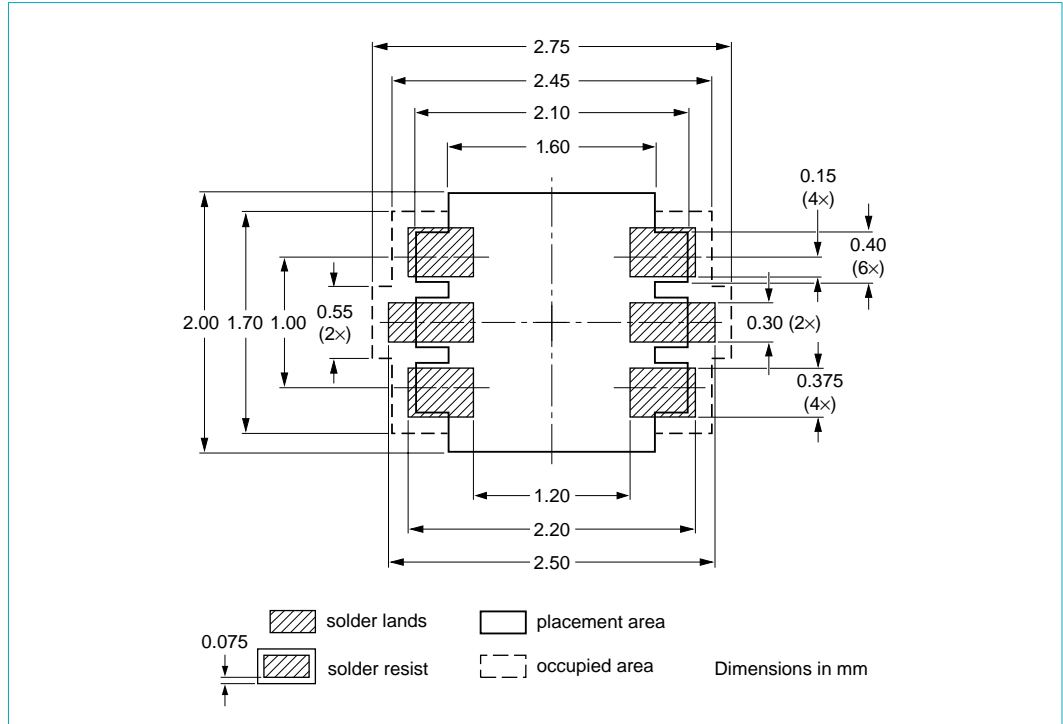

Reflow soldering is the only recommended soldering method.

Fig 14. Reflow soldering footprint SOT666

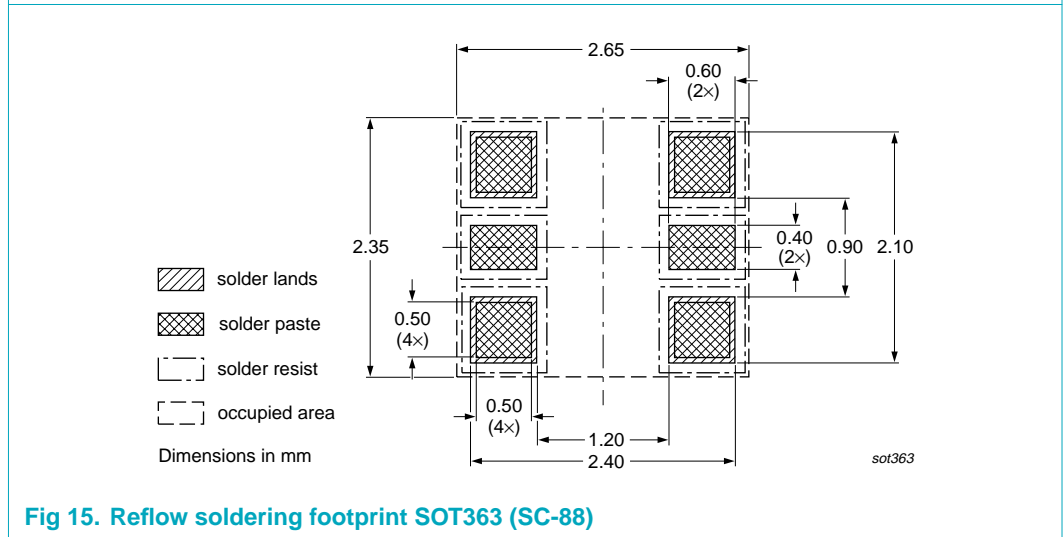

Fig 15. Reflow soldering footprint SOT363 (SC-88)

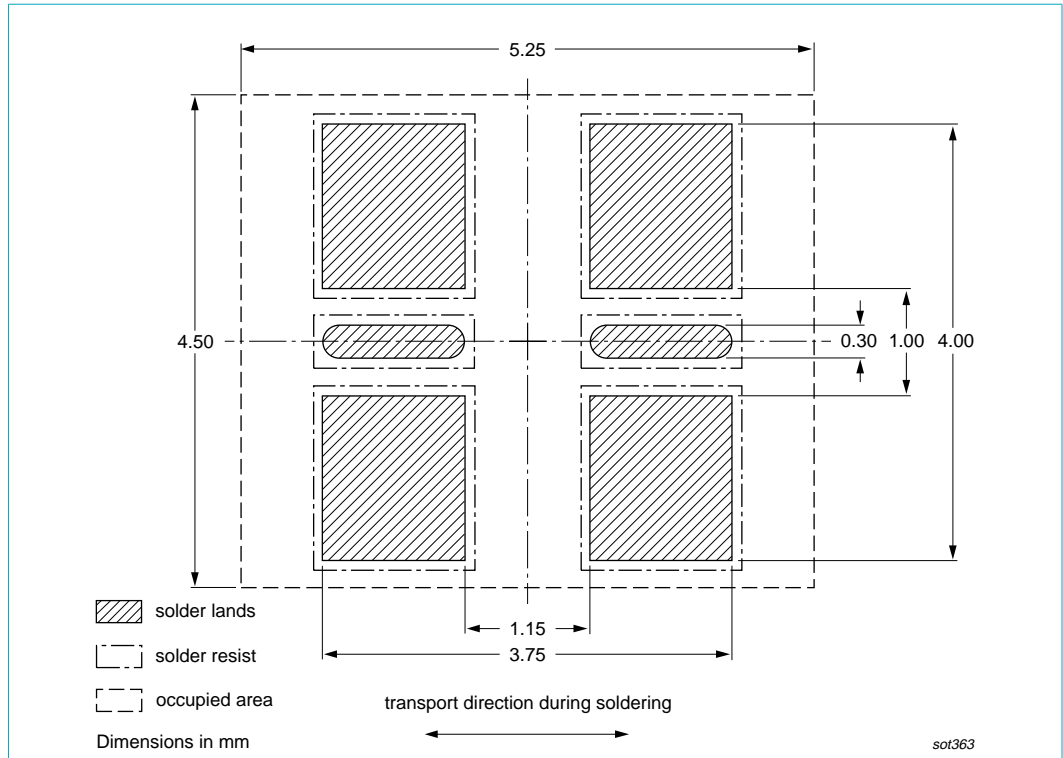

Fig 16. Wave soldering footprint SOT363 (SC-88)

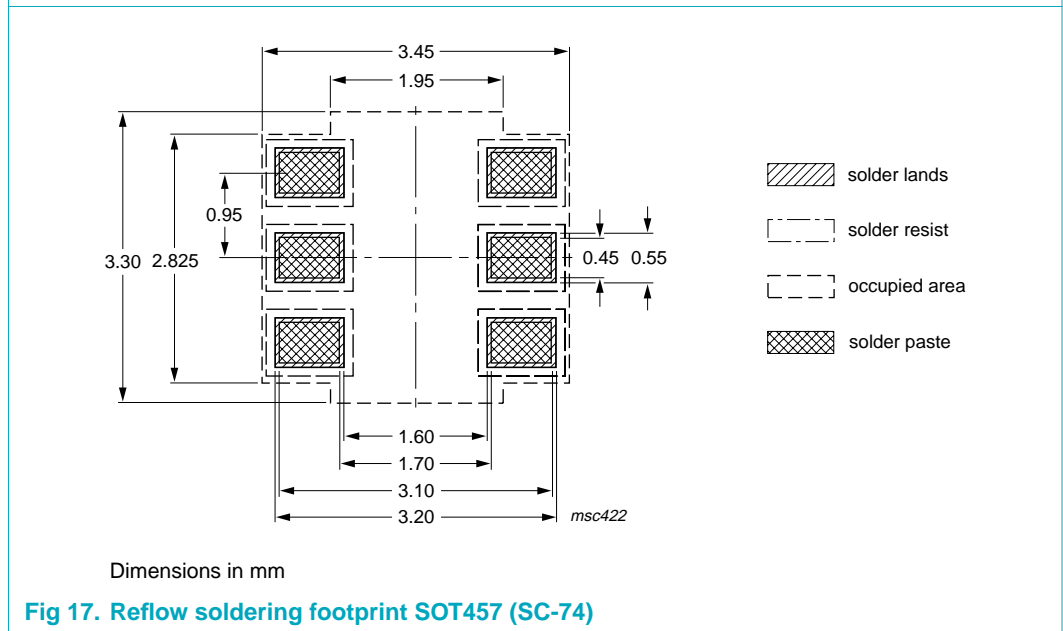
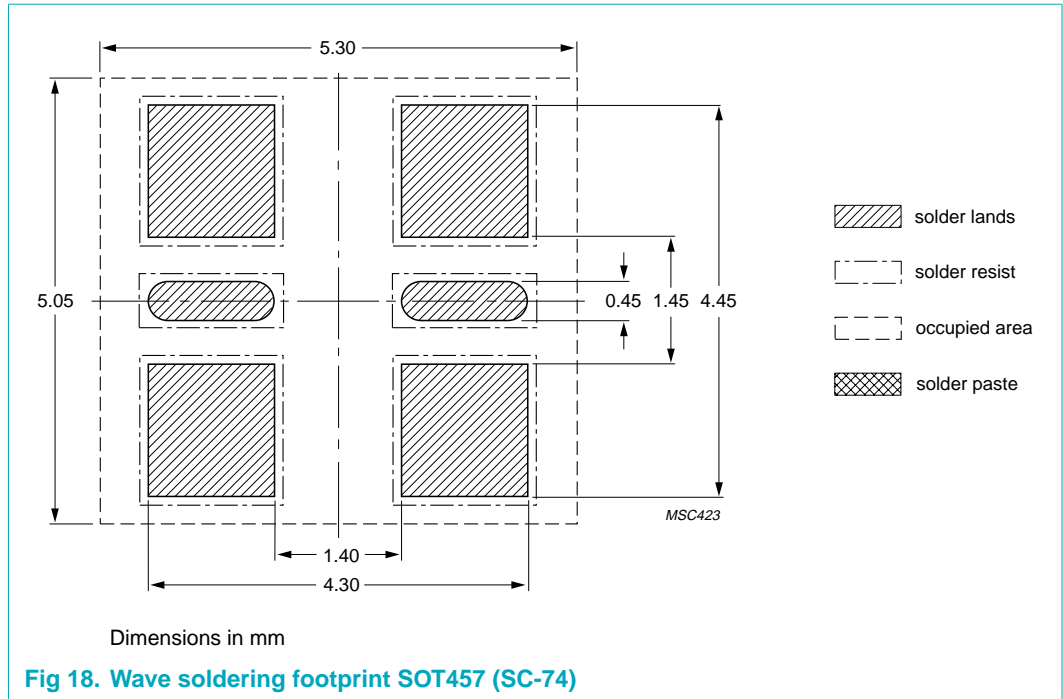

Fig 17. Reflow soldering footprint SOT457 (SC-74)



12. Revision history

Table 10. Revision history

Document ID	Release date	Data sheet status	Change notice	Supersedes
BCM857BV_BS_DS_5	20060627	Product data sheet	-	BCM857BS_DS_4
Modifications:	<ul style="list-style-type: none">Type number BCM857BV addedSection 13 "Legal information": updated			
BCM857BS_DS_4	20060216	Product data sheet	-	BCM857BS_DS_3
BCM857BS_DS_3	20060130	Product data sheet	-	BCM857BS_2
BCM857BS_2	20050411	Product data sheet	-	BCM857BS_1
BCM857BS_1	20040914	Product data sheet	-	-

13. Legal information

13.1 Data sheet status

Document status ^{[1][2]}	Product status ^[3]	Definition
Objective [short] data sheet	Development	This document contains data from the objective specification for product development.
Preliminary [short] data sheet	Qualification	This document contains data from the preliminary specification.
Product [short] data sheet	Production	This document contains the product specification.

[1] Please consult the most recently issued document before initiating or completing a design.

[2] The term 'short data sheet' is explained in section "Definitions".

[3] The product status of device(s) described in this document may have changed since this document was published and may differ in case of multiple devices. The latest product status information is available on the Internet at URL <http://www.semiconductors.philips.com>.

13.2 Definitions

Draft — The document is a draft version only. The content is still under internal review and subject to formal approval, which may result in modifications or additions. Philips Semiconductors does not give any representations or warranties as to the accuracy or completeness of information included herein and shall have no liability for the consequences of use of such information.

Short data sheet — A short data sheet is an extract from a full data sheet with the same product type number(s) and title. A short data sheet is intended for quick reference only and should not be relied upon to contain detailed and full information. For detailed and full information see the relevant full data sheet, which is available on request via the local Philips Semiconductors sales office. In case of any inconsistency or conflict with the short data sheet, the full data sheet shall prevail.

13.3 Disclaimers

General — Information in this document is believed to be accurate and reliable. However, Philips Semiconductors does not give any representations or warranties, expressed or implied, as to the accuracy or completeness of such information and shall have no liability for the consequences of use of such information.

Right to make changes — Philips Semiconductors reserves the right to make changes to information published in this document, including without limitation specifications and product descriptions, at any time and without notice. This document supersedes and replaces all information supplied prior to the publication hereof.

Suitability for use — Philips Semiconductors products are not designed, authorized or warranted to be suitable for use in medical, military, aircraft, space or life support equipment, nor in applications where failure or

malfunction of a Philips Semiconductors product can reasonably be expected to result in personal injury, death or severe property or environmental damage. Philips Semiconductors accepts no liability for inclusion and/or use of Philips Semiconductors products in such equipment or applications and therefore such inclusion and/or use is at the customer's own risk.

Applications — Applications that are described herein for any of these products are for illustrative purposes only. Philips Semiconductors makes no representation or warranty that such applications will be suitable for the specified use without further testing or modification.

Limiting values — Stress above one or more limiting values (as defined in the Absolute Maximum Ratings System of IEC 60134) may cause permanent damage to the device. Limiting values are stress ratings only and operation of the device at these or any other conditions above those given in the Characteristics sections of this document is not implied. Exposure to limiting values for extended periods may affect device reliability.

Terms and conditions of sale — Philips Semiconductors products are sold subject to the general terms and conditions of commercial sale, as published at <http://www.semiconductors.philips.com/profile/terms>, including those pertaining to warranty, intellectual property rights infringement and limitation of liability, unless explicitly otherwise agreed to in writing by Philips Semiconductors. In case of any inconsistency or conflict between information in this document and such terms and conditions, the latter will prevail.

No offer to sell or license — Nothing in this document may be interpreted or construed as an offer to sell products that is open for acceptance or the grant, conveyance or implication of any license under any copyrights, patents or other industrial or intellectual property rights.

13.4 Trademarks

Notice: All referenced brands, product names, service names and trademarks are the property of their respective owners.

14. Contact information

For additional information, please visit: <http://www.semiconductors.philips.com>

For sales office addresses, send an email to: sales.addresses@www.semiconductors.philips.com

15. Contents

1	Product profile	1
1.1	General description	1
1.2	Features	1
1.3	Applications	1
1.4	Quick reference data	1
2	Pinning information	2
3	Ordering information	2
4	Marking	2
5	Limiting values	3
6	Thermal characteristics	3
7	Characteristics	4
8	Application information	8
9	Package outline	8
10	Packing information	9
11	Soldering	10
12	Revision history	13
13	Legal information	14
13.1	Data sheet status	14
13.2	Definitions	14
13.3	Disclaimers	14
13.4	Trademarks	14
14	Contact information	14
15	Contents	15



Please be aware that important notices concerning this document and the product(s) described herein, have been included in section 'Legal information'.

© Koninklijke Philips Electronics N.V. 2006. All rights reserved.

For more information, please visit: <http://www.semiconductors.philips.com>.

For sales office addresses, email to: sales.addresses@www.semiconductors.philips.com.

Date of release: 27 June 2006

Document identifier: BCM857BV_BS_DS_5