

Smart Highside Power Switch for Industrial Applications

Features

- Overload protection
- Current limitation
- Short circuit protection
- Thermal shutdown
- Overvoltage protection (including load dump)
- Fast demagnetization of inductive loads
- Reverse battery protection¹⁾
- Undervoltage and overvoltage shutdown with auto-restart and hysteresis
- Open drain diagnostic output
- Open load detection in ON-state
- CMOS compatible input
- Loss of ground and loss of V_{bb} protection
- Electrostatic discharge (ESD) protection

Product Summary

Overvoltage protection	$V_{bb(AZ)}$	65	V
Operating voltage	$V_{bb(on)}$	4.7 ... 42	V
On-state resistance	R_{ON}	220	m Ω
Load current (ISO)	$I_{L(ISO)}$	1.8	A
Current limitation	$I_{L(SCr)}$	5	A
Operating temperature	T_a	-30...+85	°C

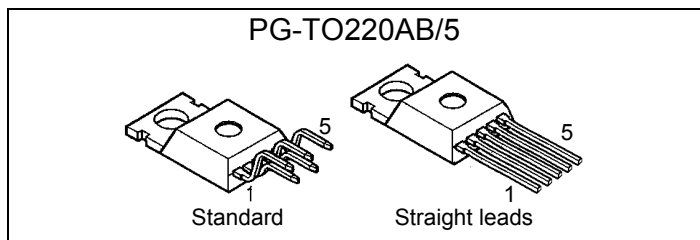

Application

- μ C compatible power switch with diagnostic feedback for 12 V and 24 V DC grounded loads in industrial applications
- All types of resistive, inductive and capacitive loads
- Replaces electromechanical relays, fuses and discrete circuits

General Description

N channel vertical power FET with charge pump, ground referenced CMOS compatible input and diagnostic feedback, monolithically integrated in Smart SIPMOS® technology. Providing embedded protective functions.

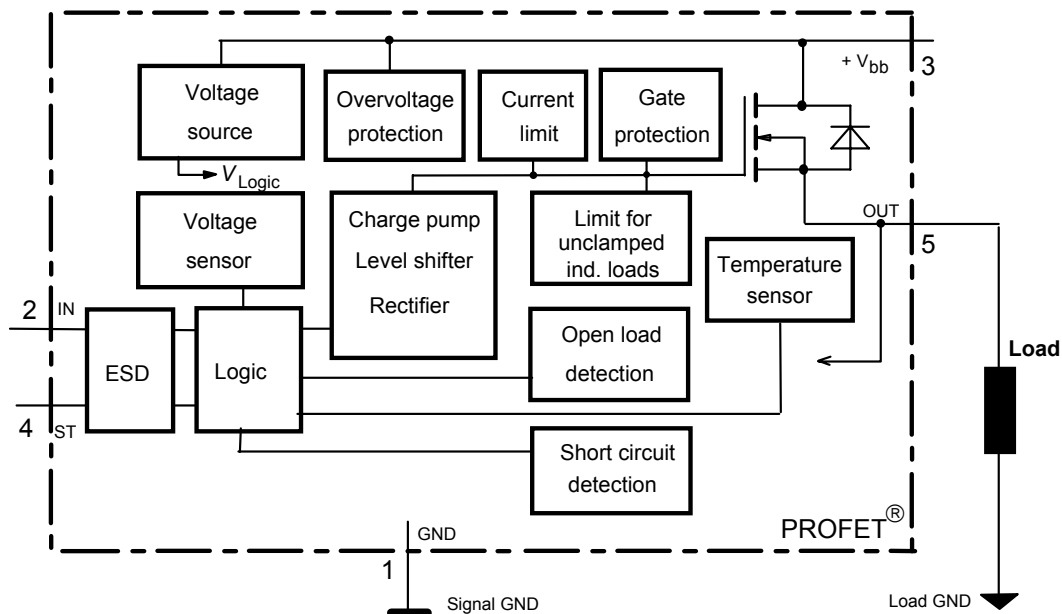

¹⁾ With external current limit (e.g. resistor $R_{GND}=150\ \Omega$) in GND connection, resistors in series with IN and ST connections, reverse load current limited by connected load.

Pin	Symbol		Function
1	GND	-	Logic ground
2	IN	I	Input, activates the power switch in case of logical high signal
3	V _{bb}	+	Positive power supply voltage, the tab is shorted to this pin
4	ST	S	Diagnostic feedback, low on failure
5	OUT (Load, L)	O	Output to the load

Maximum Ratings at $T_j = 25\text{ °C}$ unless otherwise specified

Parameter	Symbol	Values	Unit
Supply voltage (overvoltage protection see page 3)	V_{bb}	65	V
Load dump protection ²⁾ $V_{LoadDump} = U_A + V_S$, $U_A = 13.5\text{ V}$ $R_1^3 = 2\ \Omega$, $R_L = 6.6\ \Omega$, $t_d = 400\text{ ms}$, IN= low or high	$V_{Load\ dump}^4)$	100	V
Load current (Short circuit current, see page 4)	I_L	self-limited	A
Junction temperature	T_j	+150	°C
Operating temperature range	T_a	-30 ... +85	
Storage temperature range	T_{stg}	-40 ... +105	
Power dissipation (DC), $T_C \leq 25\text{ °C}$	P_{tot}	50	W
Inductive load switch-off energy dissipation, single pulse $V_{bb} = 12\text{V}$, $T_{j,start} = 150\text{°C}$, $T_C = 150\text{°C}$ const. $I_L = 1.8\text{ A}$, $Z_L = 2.3\text{ H}$, $0\ \Omega$:	E_{AS}	4.5	J
Electrostatic discharge capability (ESD) (Human Body Model) acc. MIL-STD883D, method 3015.7 and ESD assn. std. S5.1-1993	IN: V_{ESD} all other pins:	1 2	kV
Input voltage (DC)	V_{IN}	-0.5 ... +6	V
Current through input pin (DC)	I_{IN}	±5.0	mA
Current through status pin (DC)	I_{ST}	±5.0	
see internal circuit diagrams page 6			

Thermal Characteristics

Parameter and Conditions	Symbol	Values			Unit
		min	typ	max	
Thermal resistance chip - case:	R_{thJC}	--	--	2.5	K/W
junction - ambient (free air):	R_{thJA}	--	--	75	

²⁾ Supply voltages higher than $V_{bb(AZ)}$ require an external current limit for the GND and status pins, e.g. with a $150\ \Omega$ resistor in the GND connection and a $15\text{ k}\Omega$ resistor in series with the status pin. A resistor for the protection of the input is integrated.



³⁾ R_1 = internal resistance of the load dump test pulse generator

⁴⁾ $V_{Load\ dump}$ is setup without the DUT connected to the generator per ISO 7637-1 and DIN 40839

Electrical Characteristics

Parameter and Conditions at $T_j = 25\text{ °C}$, $V_{bb} = 12\text{ V}$ unless otherwise specified	Symbol	Values			Unit
		min	typ	max	

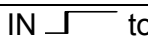
Load Switching Capabilities and Characteristics

On-state resistance (pin 3 to 5) $I_L = 1.6\text{ A}$	$T_j = 25\text{ °C}$: $T_j = 150\text{ °C}$:	R_{ON}	--	190 390	220 440	mΩ
Nominal load current, ISO Norm (pin 3 to 5) $V_{ON} = 0.5\text{ V}$, $T_C = 85\text{ °C}$		$I_{L(ISO)}$	1.6	1.8	--	A
Output current (pin 5) while GND disconnected or GND pulled up, $V_{bb} = 30\text{ V}$, $V_{IN} = 0$, see diagram page 7, $T_j = -40...+150\text{ °C}$		$I_{L(GNDhigh)}$	--	--	1	mA
Turn-on time IN  to 90% V_{OUT} :		t_{on}	12	--	125	μs
Turn-off time IN  to 10% V_{OUT} :		t_{off}	5	--	85	μs
$R_L = 12\text{ Ω}$, $T_j = -40...+150\text{ °C}$						
Slew rate on 10 to 30% V_{OUT} , $R_L = 12\text{ Ω}$, $T_j = -40...+150\text{ °C}$		dV/dt_{on}	--	--	3	V/μs
Slew rate off 70 to 40% V_{OUT} , $R_L = 12\text{ Ω}$, $T_j = -40...+150\text{ °C}$		$-dV/dt_{off}$	--	--	6	V/μs

Operating Parameters

Operating voltage ⁵⁾	$T_j = -40...+150\text{ °C}$:	$V_{bb(on)}$	4.7	--	42	V
Undervoltage shutdown	$T_j = 25\text{ °C}$:	$V_{bb(under)}$	2.9	--	4.5	V
	$T_j = -40...+150\text{ °C}$:		2.7	--	4.7	
Undervoltage restart	$T_j = -40...+150\text{ °C}$:	$V_{bb(u\text{ rst})}$	--	--	4.9	V
Undervoltage restart of charge pump see diagram page 13		$V_{bb(ucp)}$	--	5.6	6.0	V
Undervoltage hysteresis $\Delta V_{bb(under)} = V_{bb(u\text{ rst})} - V_{bb(under)}$		$\Delta V_{bb(under)}$	--	0.1	--	V
Overvoltage shutdown	$T_j = -40...+150\text{ °C}$:	$V_{bb(over)}$	42	--	52	V
Overvoltage restart	$T_j = -40...+150\text{ °C}$:	$V_{bb(o\text{ rst})}$	40	--	--	V
Overvoltage hysteresis	$T_j = -40...+150\text{ °C}$:	$\Delta V_{bb(over)}$	--	0.1	--	V
Overvoltage protection ⁶⁾ $I_{bb} = 4\text{ mA}$	$T_j = -40...+150\text{ °C}$:	$V_{bb(AZ)}$	65	70	--	V
Standby current (pin 3) $V_{IN} = 0$	$T_j = -40...+25\text{ °C}$: $T_j = 150\text{ °C}$:	$I_{bb(off)}$	--	10 18	15 25	μA
Leakage output current (included in $I_{bb(off)}$) $V_{IN} = 0$		$I_{L(off)}$	--	--	20	μA
Operating current (Pin 1) ⁷⁾ , $V_{IN} = 5\text{ V}$, $T_j = -40...+150\text{ °C}$		I_{GND}	--	1	2.1	mA

⁵⁾ At supply voltage increase up to $V_{bb} = 5.6\text{ V}$ typ without charge pump, $V_{OUT} \approx V_{bb} - 2\text{ V}$

⁶⁾ Measured without load. See also $V_{ON(CL)}$ in table of protection functions and circuit diagram page 7.

Parameter and Conditions at $T_j = 25^\circ\text{C}$, $V_{bb} = 12\text{V}$ unless otherwise specified	Symbol	Values			Unit
		min	typ	max	
Protection Functions⁸⁾					
Initial peak short circuit current limit (pin 3 to 5) ⁹⁾ , (max 450 μs if $V_{ON} > V_{ON(SC)}$)	$I_{L(SCp)}$				
$T_j = -40^\circ\text{C}$:		9	--	23	A
$T_j = 25^\circ\text{C}$:		--	12	--	
$T_j = +150^\circ\text{C}$:		4	--	15	
Repetitive overload shutdown current limit $V_{ON} = 8\text{V}$, $T_j = T_{jt}$ (see timing diagrams, page 12)	$I_{L(SCr)}$				
		--	5	--	A
Short circuit shutdown delay after input pos. slope $V_{ON} > V_{ON(SC)}$, min value valid only, if input "low" time exceeds 60 μs	$t_{d(SC)}$				
$T_j = -40..+150^\circ\text{C}$:		--	--	450	μs
Output clamp (inductive load switch off) at $V_{OUT} = V_{bb} - V_{ON(CL)}$ $I_L = 40\text{mA}$, $T_j = -40..+150^\circ\text{C}$:	$V_{ON(CL)}$				
$I_L = 1\text{A}$, $T_j = -40..+150^\circ\text{C}$:		61	68	73	V
		--	--	75	
Short circuit shutdown detection voltage (pin 3 to 5)	$V_{ON(SC)}$				
		--	8.5	--	V
Thermal overload trip temperature	T_{jt}				
		150	--	--	$^\circ\text{C}$
Thermal hysteresis	ΔT_{jt}				
		--	10	--	K
Reverse battery (pin 3 to 1) ¹⁰⁾	$-V_{bb}$				
		--	--	32	V
Diagnostic Characteristics					
Open load detection current (on-condition)	$I_{L(OL)}$				
$T_j = -40..150^\circ\text{C}$:		2	--	150	mA

⁷⁾ Add I_{ST} , if $I_{ST} > 0$, add I_{IN} , if $V_{IN} > 5.5\text{V}$

⁸⁾ Integrated protection functions are designed to prevent IC destruction under fault conditions described in the data sheet. Fault conditions are considered as "outside" normal operating range. Protection functions are not designed for continuous repetitive operation.

⁹⁾ Short circuit current limit for max. duration of $t_{d(SC)} \text{max} = 450\ \mu\text{s}$, prior to shutdown

¹⁰⁾ Requires 150 Ω resistor in GND connection. The reverse load current through the intrinsic drain-source diode has to be limited by the connected load. Note that the power dissipation is higher compared to normal operating conditions due to the voltage drop across the intrinsic drain-source diode. The temperature protection is not active during reverse current operation! Input and Status currents have to be limited (see max. ratings page 2 and circuit page 7).

Parameter and Conditions at $T_j = 25^\circ\text{C}$, $V_{bb} = 12\text{ V}$ unless otherwise specified	Symbol	Values			Unit
		min	typ	max	
Input and Status Feedback¹¹⁾					
Input turn-on threshold voltage \lrcorner $T_j = -40..+150^\circ\text{C}$:	$V_{IN(T+)}$	1.5	--	2.4	V
Input turn-off threshold voltage \lrcorner $T_j = -40..+150^\circ\text{C}$:	$V_{IN(T-)}$	1.0	--	--	V
Input threshold hysteresis	$\Delta V_{IN(T)}$	--	0.5	--	V
Off state input current (pin 2), $V_{IN} = 0.4\text{ V}$	$I_{IN(off)}$	1	--	30	μA
On state input current (pin 2), $V_{IN} = 5\text{ V}$	$I_{IN(on)}$	10	25	70	μA
Status invalid after positive input slope (short circuit) $T_j = -40 \dots +150^\circ\text{C}$:	$t_{d(ST\ SC)}$	--	--	450	μs
Status invalid after positive input slope (open load) $T_j = -40 \dots +150^\circ\text{C}$:	$t_{d(ST)}$	300	--	1400	μs
Status output (open drain)					
Zener limit voltage $T_j = -40\dots+150^\circ\text{C}$, $I_{ST} = +50\text{ uA}$:	$V_{ST(high)}$	5.0	6	--	V
ST low voltage $T_j = -40\dots+150^\circ\text{C}$, $I_{ST} = +1.6\text{ mA}$:	$V_{ST(low)}$	--	--	0.4	

¹¹⁾ If a ground resistor R_{GND} is used, add the voltage drop across this resistor.

Truth Table

	Input-level	Output level	Status 410 E2
Normal operation	L	L	H
	H	H	H
Open load	L	¹²⁾	H
	H	H	L
Short circuit to GND	L	L	H
	H	L	L
Short circuit to V _{bb}	L	H	H
	H	H	H (L ¹³⁾)
Overtemperature	L	L	L
	H	L	L
Undervoltage	L	L	H
	H	L	H
Overvoltage	L	L	H
	H	L	H

L = "Low" Level X = don't care Z = high impedance, potential depends on external circuit
H = "High" Level Status signal after the time delay shown in the diagrams (see fig 5. page 13)

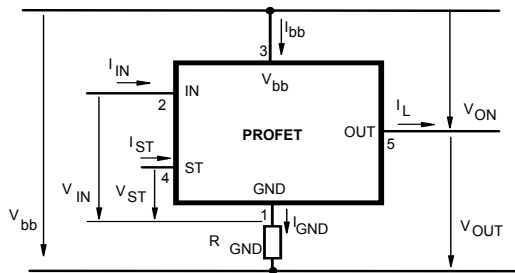
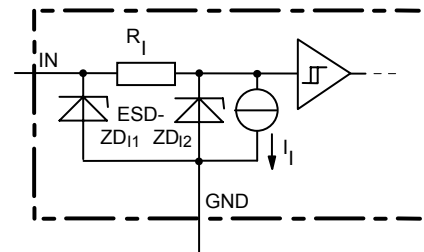
Terms

Input circuit (ESD protection)

ZD11 6 V typ., ESD zener diodes are not to be used as voltage clamp at DC conditions. Operation in this mode may result in a drift of the zener voltage (increase of up to 1 V).

¹²⁾ Power Transistor off, high impedance.

¹³⁾ Low resistance short V_{bb} to output may be detected in ON-state by the no-load-detection

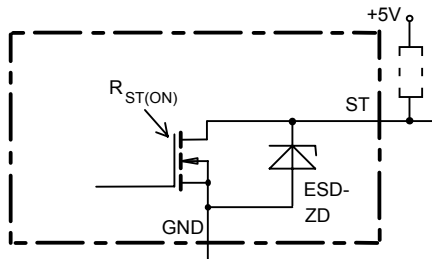
Status output



ESD-Zener diode: 6 V typ., max 5 mA;
 $R_{ST(ON)} < 250 \Omega$ at 1.6 mA, ESD zener diodes are not to be used as voltage clamp at DC conditions.
 Operation in this mode may result in a drift of the zener voltage (increase of up to 1 V).

Short circuit detection

Fault Condition: $V_{ON} > 8.5 \text{ V typ.}$; IN high

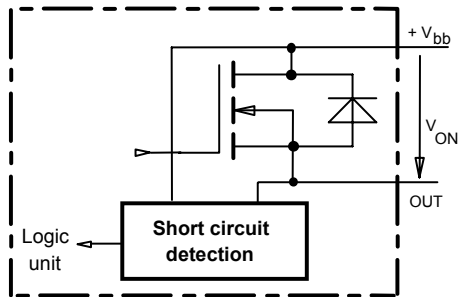

Inductive and overvoltage output clamp

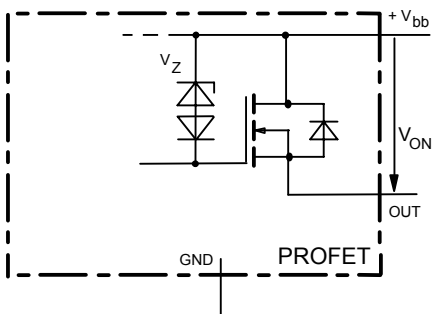

V_{ON} clamped to 68 V typ.

Overvolt. and reverse batt. protection

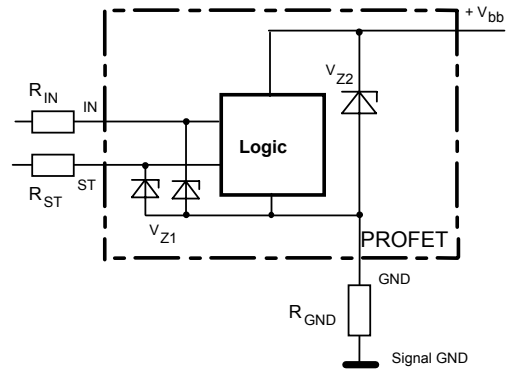

$V_{Z1} = 6.2 \text{ V typ.}$, $V_{Z2} = 70 \text{ V typ.}$, $R_{GND} = 150 \Omega$, R_{IN} , $R_{ST} = 15 \text{ k}\Omega$

Open-load detection

ON-state diagnostic condition: $V_{ON} < R_{ON} * I_{L(OL)}$; IN high

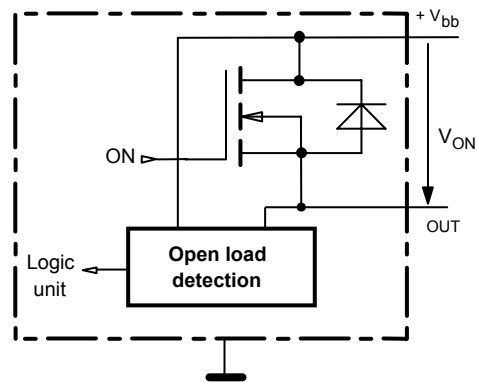

GND disconnect

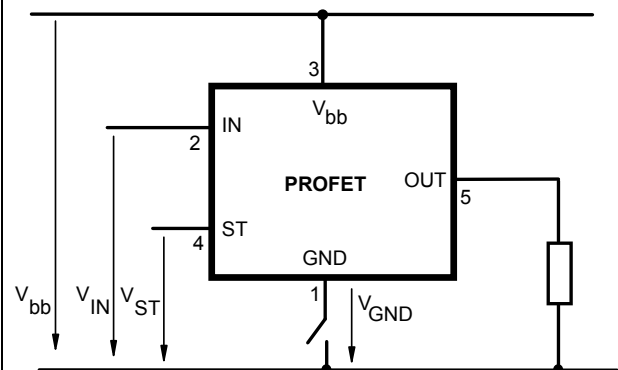

Any kind of load. In case of Input=high is $V_{OUT} \approx V_{IN} - V_{IN(T+)}$.
 Due to $V_{GND} > 0$, no $V_{ST} = \text{low}$ signal available.

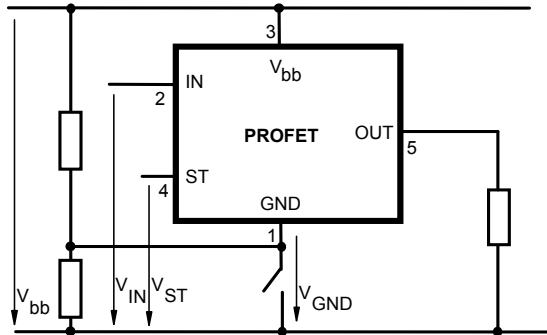
GND disconnect with GND pull up

Any kind of load. If $V_{GND} > V_{IN} - V_{IN(T+)}$ device stays off
 Due to $V_{GND} > 0$, no $V_{ST} = \text{low}$ signal available.

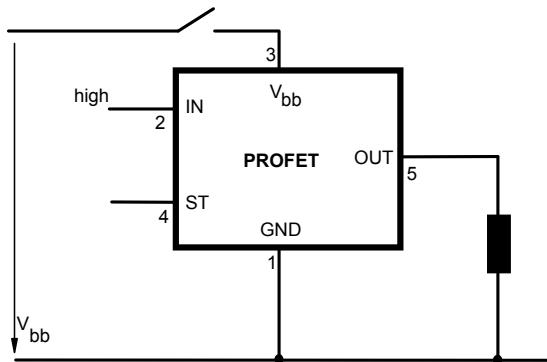
V_{bb} disconnect with energized inductive load

Normal load current can be handled by the PROFET itself.

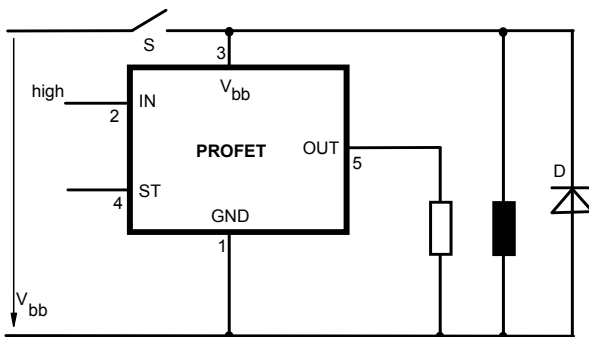
V_{bb} disconnect with charged external inductive load

If other external inductive loads L are connected to the PROFET, additional elements like D are necessary.

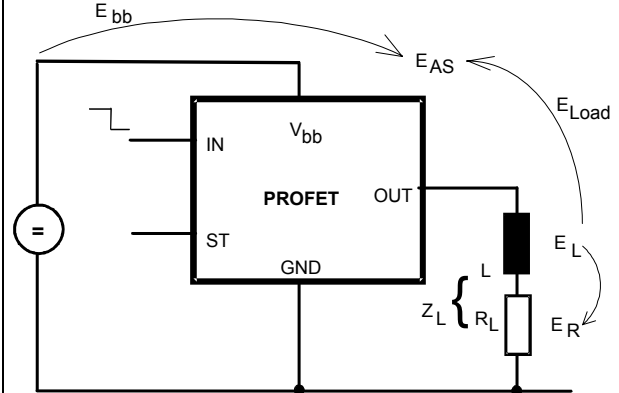
Inductive Load switch-off energy dissipation

Energy stored in load inductance:

$$E_L = \frac{1}{2} \cdot L \cdot I_L^2$$

While demagnetizing load inductance, the energy dissipated in PROFET is

$$E_{AS} = E_{bb} + E_L - E_R = \int V_{ON(CL)} \cdot i_L(t) dt,$$

with an approximate solution for $R_L > 0 \Omega$:

$$E_{AS} = \frac{I_L \cdot L}{2 \cdot R_L} \cdot (V_{bb} + |V_{OUT(CL)}|) \cdot \ln \left(1 + \frac{I_L \cdot R_L}{|V_{OUT(CL)}|} \right)$$

Maximum allowable load inductance for a single switch off

$L = f(I_L)$; $T_{j,start} = 150^\circ\text{C}$, $T_C = 150^\circ\text{C}$ const.,

$V_{bb} = 12\text{V}$, $R_L = 0 \Omega$

L [mH]

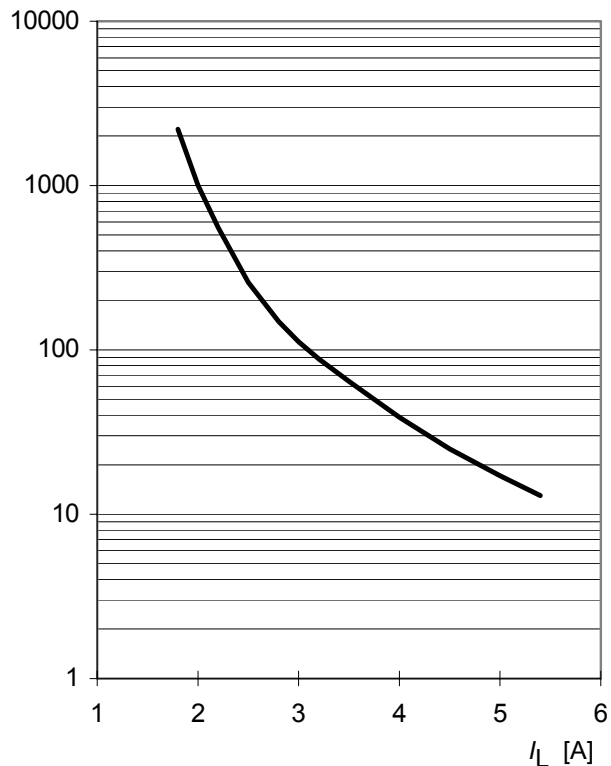

Typ. transient thermal impedance chip case

$$Z_{thJC} = f(t_p, D), D = t_p / T$$

Z_{thJC} [K/W]

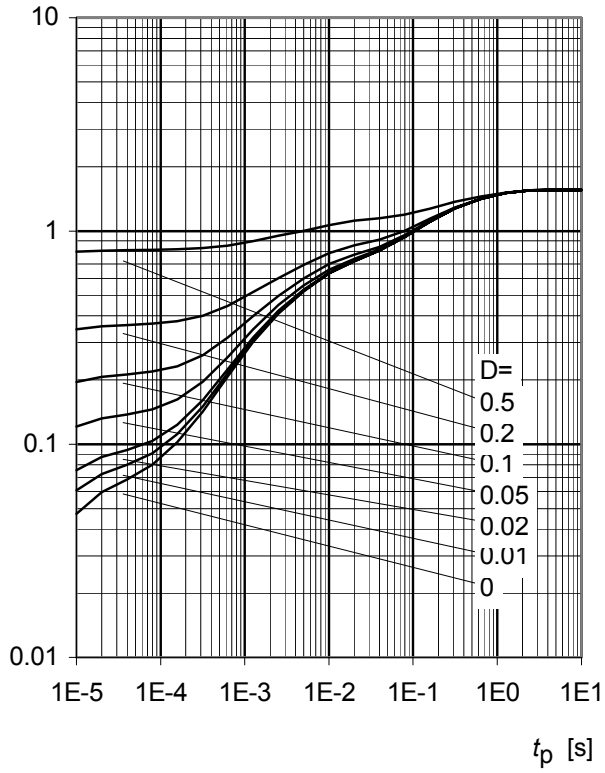

Options Overview
High-side switch, Input protection, ESD protection, load dump and reverse battery protection with 150 Ω in GND connection, protection against loss of ground

Type	ITS410E2
Logic version	E
Overtemperature protection with hysteresis $T_j > 150\text{ °C}$, latch function ¹⁴⁾ ¹⁵⁾ $T_j > 150\text{ °C}$, with auto-restart on cooling	X
Short circuit to GND protection switches off when $V_{ON} > 3.5\text{ V typ.}$ and $V_{bb} > 7\text{ V typ.}$ ¹⁴⁾ (when first turned on after approx. 150 μs) switches off when $V_{ON} > 8.5\text{ V typ.}$ ¹⁴⁾ (when first turned on after approx. 150 μs) Achieved through overtemperature protection	X
Open load detection in OFF-state with sensing current 30 μA typ. in ON-state with sensing voltage drop across power transistor	X
Undervoltage shutdown with auto restart	X
Overvoltage shutdown with auto restart ¹⁶⁾	X
Status feedback for overtemperature short circuit to GND short to V_{bb} open load undervoltage overvoltage	X X - ¹⁷⁾ X - -
Status output type CMOS Open drain	X
Output negative voltage transient limit (fast inductive load switch off) to $V_{bb} - V_{ON(CL)}$	X
Load current limit high level (can handle loads with high inrush currents) low level (better protection of application)	X
Protection against loss of GND	X

¹⁴⁾ Latch except when $V_{bb} - V_{OUT} < V_{ON(SC)}$ after shutdown. In most cases $V_{OUT} = 0\text{ V}$ after shutdown ($V_{OUT} \neq 0\text{ V}$ only if forced externally). So the device remains latched unless $V_{bb} < V_{ON(SC)}$ (see page 4). No latch between turn on and $t_{d(SC)}$.

¹⁵⁾ With latch function. Reseted by a) Input low, b) Undervoltage

¹⁶⁾ No auto restart after overvoltage in case of short circuit

¹⁷⁾ Low resistance short V_{bb} to output may be detected in ON-state by the no-load-detection

Timing diagrams

Figure 1a: V_{bb} turn on:

Figure 2a: Switching a lamp,

Figure 2b: Switching an inductive load

Figure 3a: Turn on into short circuit,

Figure 3b: Turn on into overload,

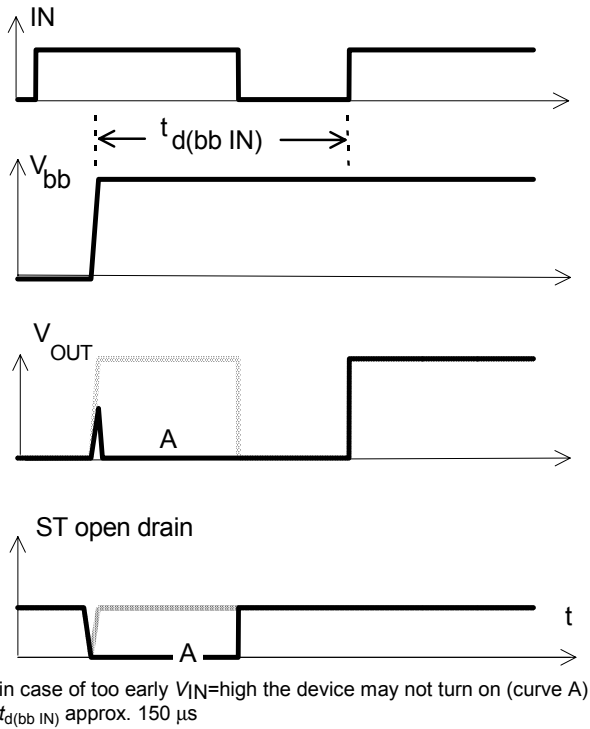
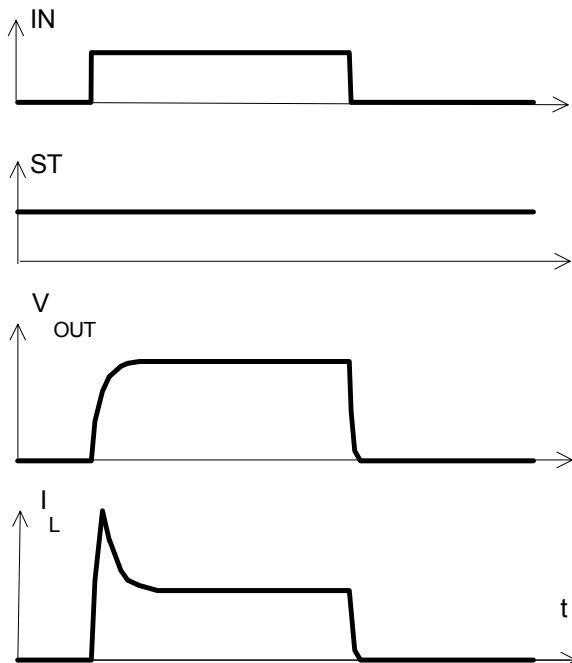
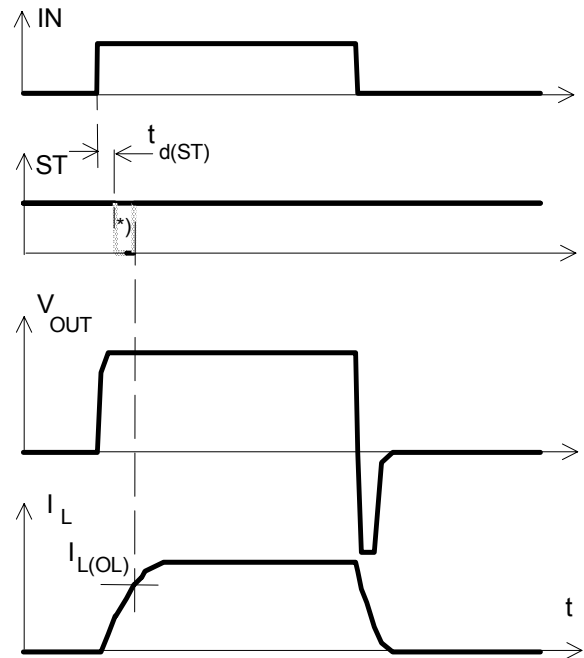
Figure 3c: Short circuit while on:

Figure 4a: Overtemperature:
 Reset if $T_j < T_{jt}$

Figure 5a: Open load: detection in ON-state, turn on/off to open load

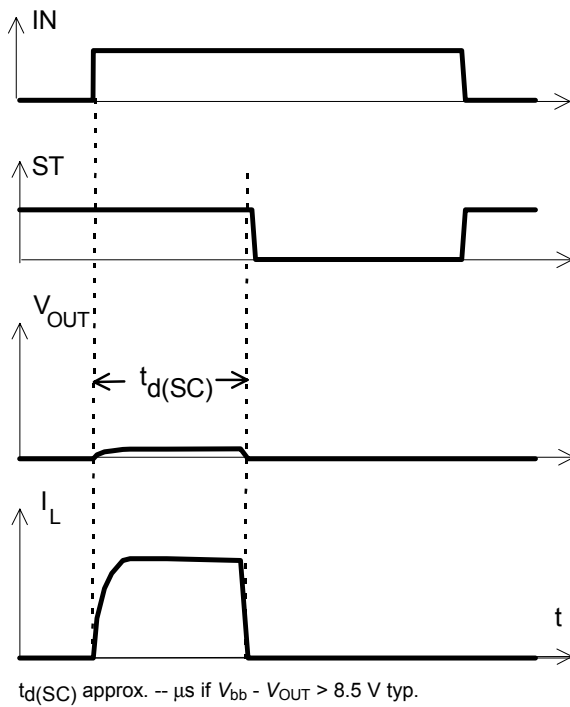
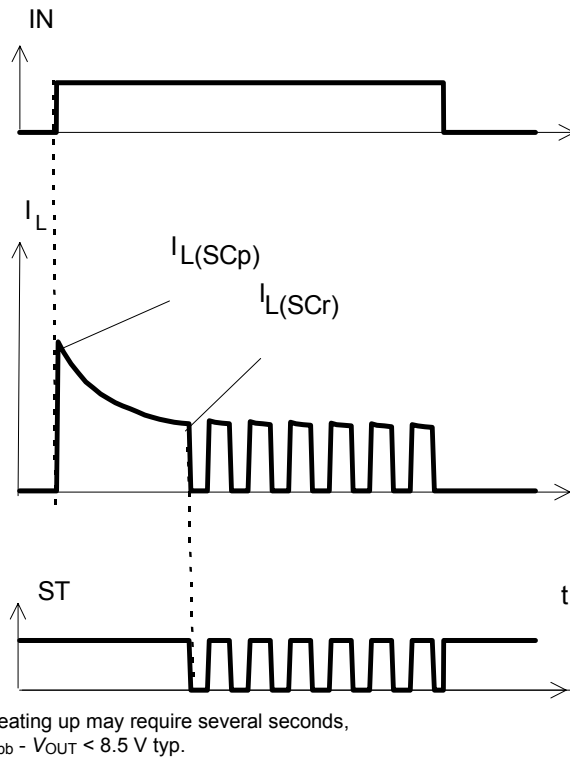
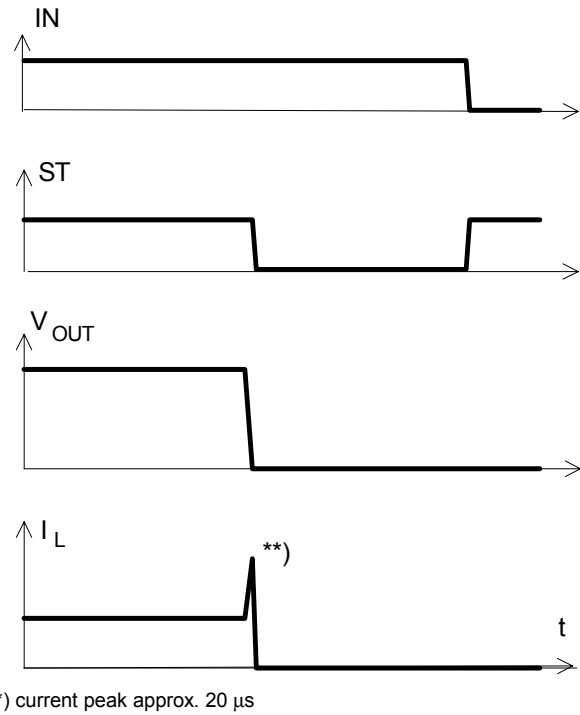
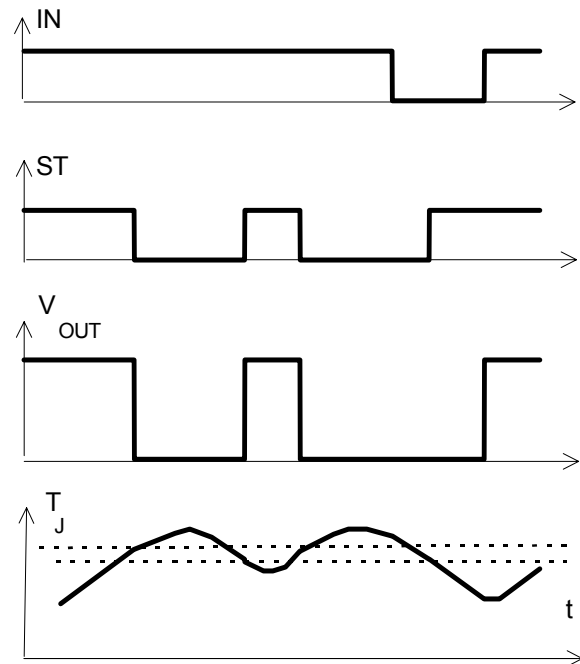
Figure 5b: Open load: detection in ON-state, open load occurs in on-state

 $t_{d(ST OL1)} = t_{bd} \mu s \text{ typ.}, t_{d(ST OL2)} = t_{bd} \mu s \text{ typ}$
Figure 6a: Undervoltage:

Figure 6b: Undervoltage restart of charge pump

Figure 7a: Overvoltage:

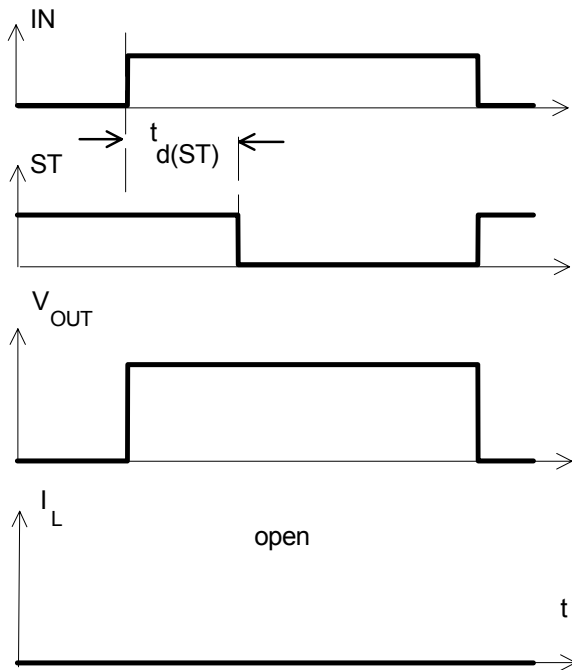
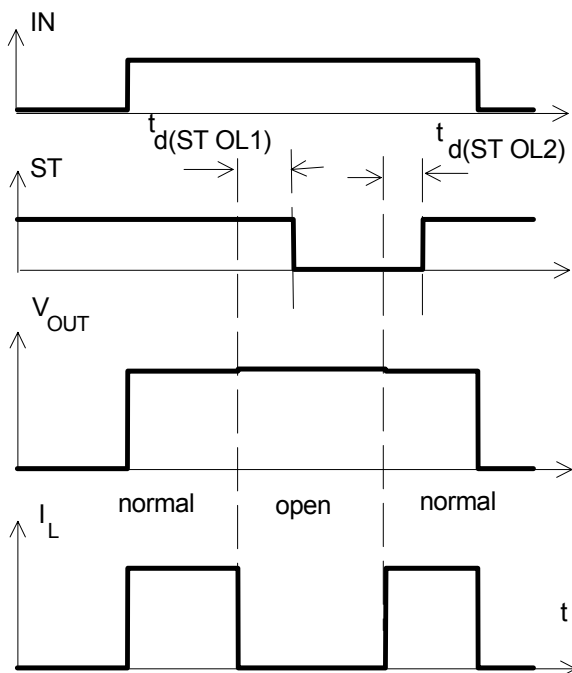
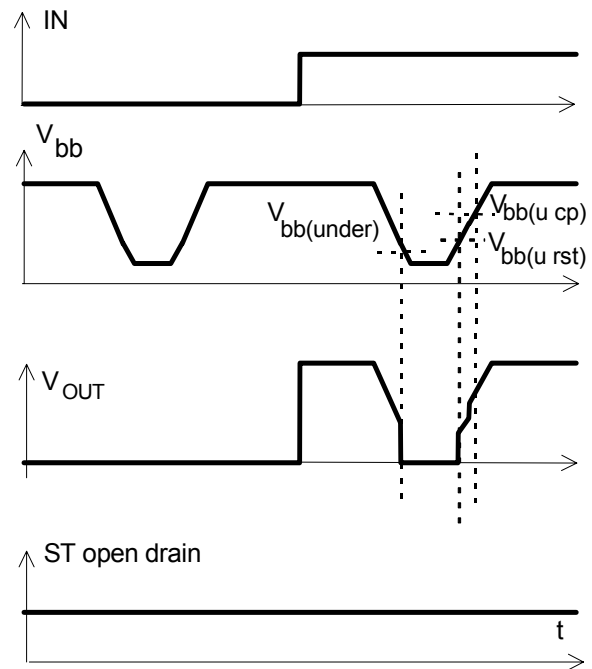
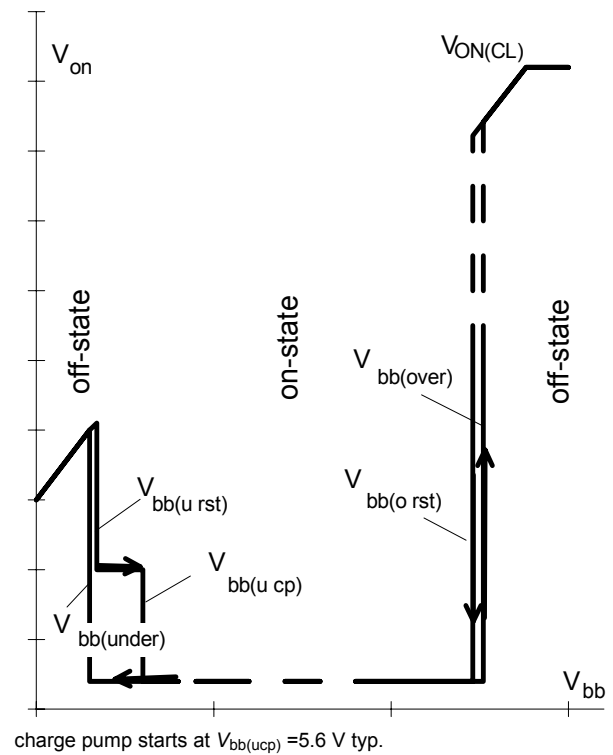
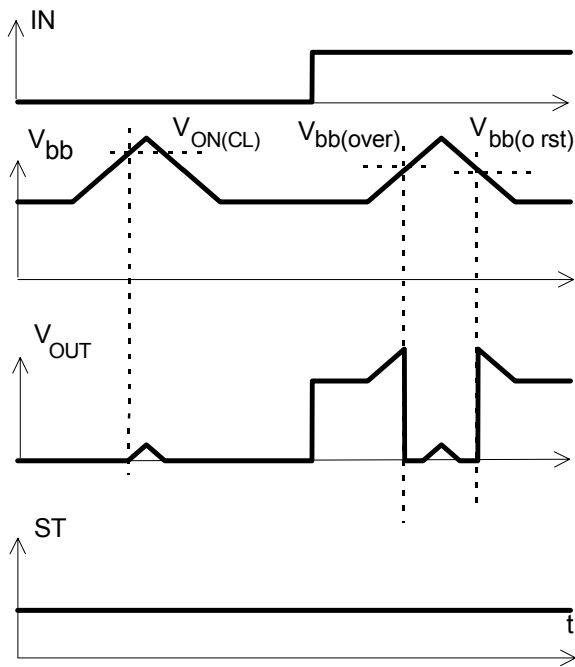
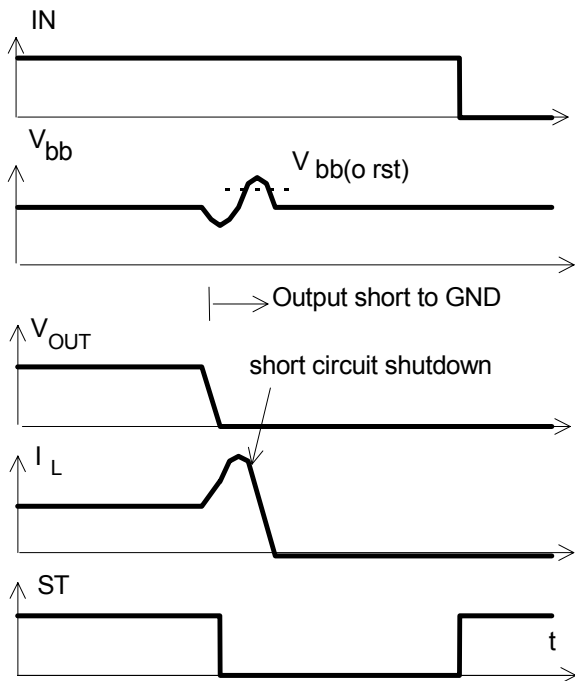
Figure 9a: Overvoltage at short circuit shutdown:

Overvoltage due to power line inductance. No overvoltage auto-restart of PROFET after short circuit shutdown.

Package and Ordering Code

All dimensions in mm

Standard PG-TO220AB/5 Ordering code

ITS 410 E2	SP000221219
------------	-------------

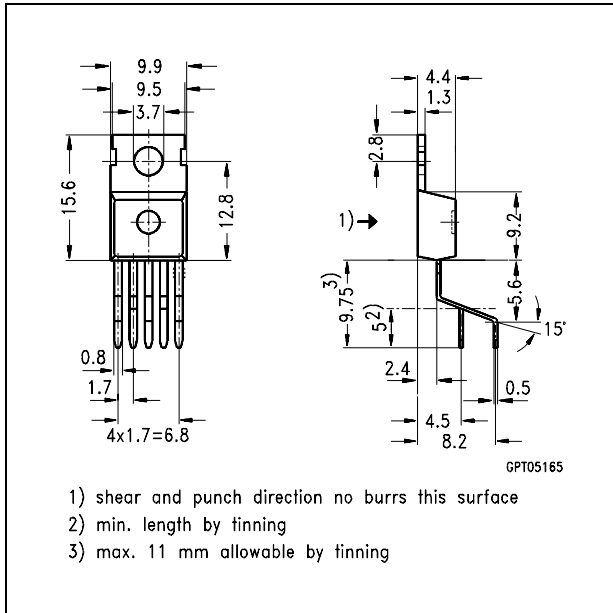

Published by
Infineon Technologies AG,
St.-Martin-Strasse 53,
D-81669 München
 © Infineon Technologies AG 2006
All Rights Reserved.

Attention please!

The information herein is given to describe certain components and shall not be considered as a guarantee of characteristics.

Terms of delivery and rights to technical change reserved.

We hereby disclaim any and all warranties, including but not limited to warranties of non-infringement, regarding circuits, descriptions and charts stated herein.

Infineon Technologies is an approved CECC manufacturer.

Information

For further information on technology, delivery terms and conditions and prices please contact your nearest Infineon Technologies Office in Germany or our Infineon Technologies Representatives worldwide (see address list).

Warnings

Due to technical requirements components may contain dangerous substances. For information on the types in question please contact your nearest Infineon Technologies Office.

Infineon Technologies Components may only be used in life-support devices or systems with the express written approval of Infineon Technologies, if a failure of such components can reasonably be expected to cause the failure of that life-support device or system, or to affect the safety or effectiveness of that device or system. Life support devices or systems are intended to be implanted in the human body, or to support and/or maintain and sustain and/or protect human life. If they fail, it is reasonable to assume that the health of the user or other persons may be endangered.

PG-TO220AB/5, Option E3043 Ordering code

ITS 410 E2 E3043	SP000221227
------------------	-------------

