

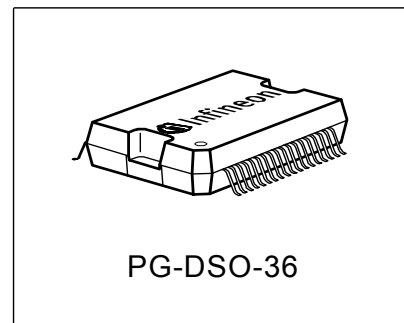
## Smart Power High-Side-Switch for Industrial Applications Eight Channels: 8 x 200 mΩ

### Features

- Output current 0,625 A per channel
- Short circuit protection
- Maximum current internally limited
- Overload protection
- Input protection
- Overvoltage protection (including load dump)
- Undervoltage shutdown with auto-restart and hysteresis
- Switching inductive loads
- Thermal shutdown with restart
- Thermal independence of separate channels
- ESD - Protection
- Loss of GND and loss of  $V_{bb}$  protection
- Very low standby current
- Reverse battery protection
- Programmable input for CMOS or  $V_{bb}/2$
- Common diagnostic output ( current output )  
for overtemperature

### Product Summary

Overvoltage protection	$V_{bb(AZ)}$	47	V
Operating voltage	$V_{bb(on)}$	11...45	V
On-state resistance	$R_{ON}$	200	mΩ
Operating temperature	$T_a$	-30...+85	°C



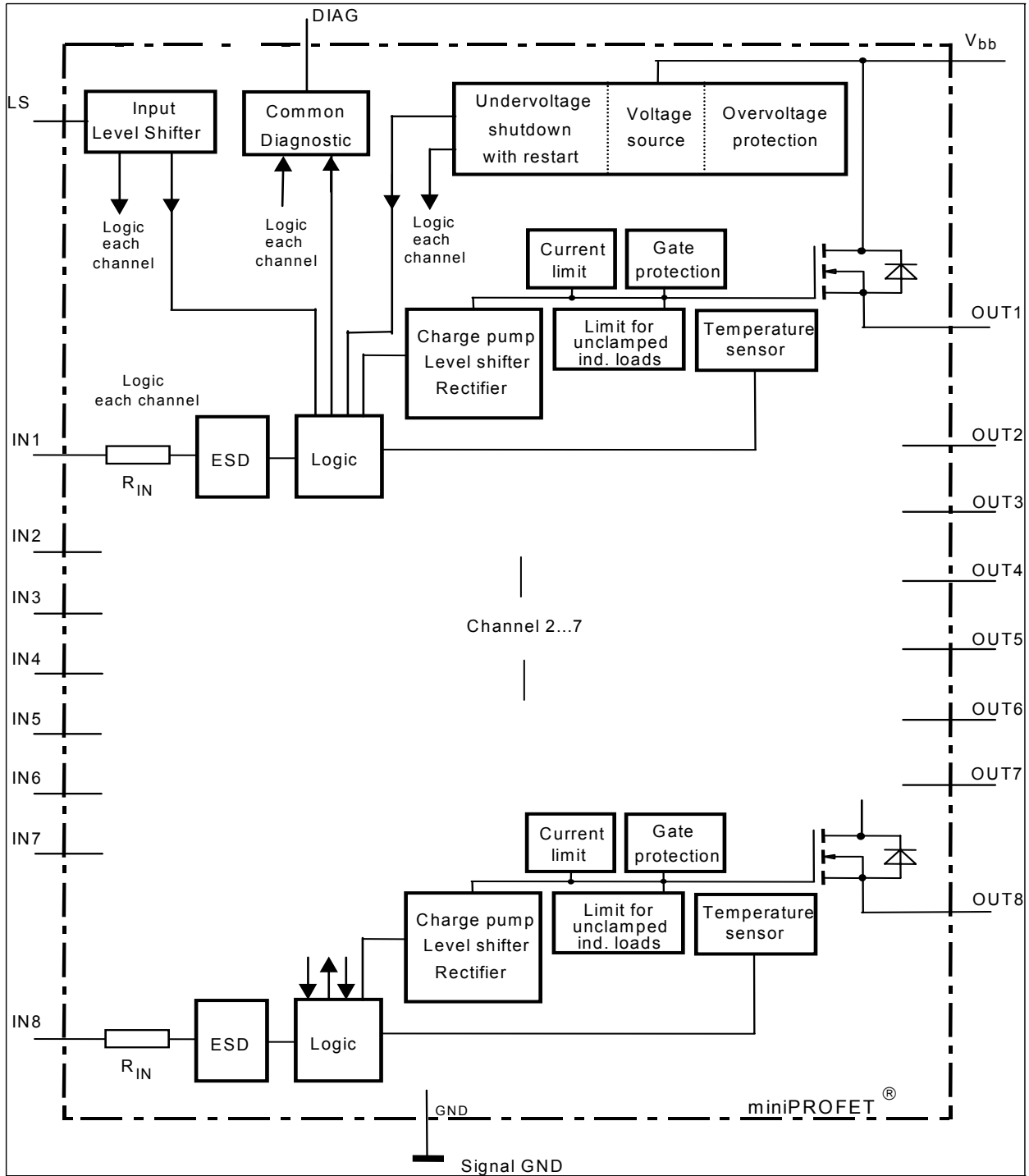
### Application

- Output driver for industrial applications ( PLC )
- All types of resistive, inductive and capacitive loads
- $\mu$ C or optocoupler compatible power switch for 24 V DC industrial applications
- Replaces electromechanical relays and discrete circuits

### General Description

N channel vertical power FET with charge pump, ground referenced CMOS or  $V_{bb}/2$  compatible input and common diagnostic feedback, monolithically integrated in Smart SIPMOS<sup>®</sup> technology. Providing embedded protective functions.

### Block Diagram



<b>Pin</b>	<b>Symbol</b>	<b>Function</b>
1,2,4,5	NC	not connected
3	LS	Enable pin for switching the input-levels to $V_{bb}/2$
6	IN1	Input, activates channel 1 in case of logic high signal
7	IN2	Input, activates channel 2 in case of logic high signal
8	IN3	Input, activates channel 3 in case of logic high signal
9	IN4	Input, activates channel 4 in case of logic high signal
10	IN5	Input, activates channel 5 in case of logic high signal
11	IN6	Input, activates channel 6 in case of logic high signal
12	IN7	Input, activates channel 7 in case of logic high signal
13	IN8	Input, activates channel 8 in case of logic high signal
14-18	NC	not connected
19	GND	Logic ground
20	DIAG	Common diagnostic output for overtemperature
21	OUT8	High-side output of channel 8
22	OUT8	High-side output of channel 8
23	OUT7	High-side output of channel 7
24	OUT7	High-side output of channel 7
25	OUT6	High-side output of channel 6
26	OUT6	High-side output of channel 6
27	OUT5	High-side output of channel 5
28	OUT5	High-side output of channel 5
29	OUT4	High-side output of channel 4
30	OUT4	High-side output of channel 4
31	OUT3	High-side output of channel 3
32	OUT3	High-side output of channel 3
33	OUT2	High-side output of channel 2
34	OUT2	High-side output of channel 2
35	OUT1	High-side output of channel 1
36	OUT1	High-side output of channel 1
TAB	Vbb	Positive power supply voltage

**Maximum Ratings**

Parameter	Symbol	Value	Unit
at $T_j = -40...135\text{ °C}$ , unless otherwise specified			
Supply voltage	$V_{bb}$	-11)...45	V
Continuous input voltage <sup>2)</sup>	$V_{IN}$	-10... $V_{bb}$	
Continuous voltage at LS-pin	$V_{LS}$	-1... $V_{bb}$	
Load current (Short - circuit current, see page 6)	$I_L$	self limited	A
Current through input pin (DC), each channel	$I_{IN}$	±5	mA
Reverse current through GND-pin <sup>1)</sup>	$-I_{GND}$	1.6	A
Junction temperature	$T_j$	internal limited	°C
Operating temperature	$T_a$	-30...+85	°C
Storage temperature	$T_{stg}$	-40 ... +105	°C
Power dissipation <sup>3)</sup>	$P_{tot}$	3.3	W
Inductive load switch-off energy dissipation <sup>4)</sup> single pulse, $T_j = 125\text{ °C}$ , $I_L = 0.625\text{ A}$ one channel active all channels simultaneously active ( each channel )	$E_{AS}$	10 1	J
Load dump protection <sup>4)</sup> $V_{LoadDump}^{5)} = V_A + V_S$ $V_{IN}$ = low or high $t_d = 400\text{ ms}$ , $R_I = 2\ \Omega$ , $R_L = 27\ \Omega$ , $V_A = 13.5\text{ V}$ $t_d = 350\text{ ms}$ , $R_I = 2\ \Omega$ , $R_L = 47\ \Omega$ , $V_A = 27\text{ V}$	$V_{Loaddump}$	90 117	V
<b>Electrostatic discharge voltage (Human Body Model)</b> according to ANSI EOS/ESD - S5.1 - 1993, ESD STM5.1 - 1998 Input pin, LS pin, Common diagnostic pin all other pins	$V_{ESD}$	±1 ±5	kV
Continuous reverse drain current <sup>1)4)</sup> , each channel	$I_S$	4	A

<sup>1)</sup>defined by  $P_{tot}$

<sup>2)</sup>At  $V_{IN} > V_{bb}$ , the input current is not allowed to exceed ±5 mA.

<sup>3)</sup> Device on 50mm\*50mm\*1.5mm epoxy PCB FR4 with 6 cm<sup>2</sup> (one layer, 70µm thick) copper area for drain connection. PCB is vertical without blown air.

<sup>4)</sup>not subject to production test, specified by design

<sup>5)</sup> $V_{Loaddump}$  is setup without the DUT connected to the generator per ISO 7637-1 and DIN 40839 .

Supply voltages higher than  $V_{bb(AZ)}$  require an external current limit for the GND pin, e.g. with a 150Ω resistor in GND connection. A resistor for the protection of the input is integrated.

**Electrical Characteristics**

Parameter at $T_j = -25...125^\circ\text{C}$ , $V_{bb} = 15...30\text{V}$ , unless otherwise specified	Symbol	Values			Unit
		min.	typ.	max.	

**Thermal Characteristics**

Thermal resistance junction - case	$R_{thJC}$	-	-	1.5	K/W
Thermal resistance @ min. footprint	$R_{th(JA)}$	-	-	50	
Thermal resistance @ 6 cm <sup>2</sup> cooling area <sup>1)</sup>	$R_{th(JA)}$	-	-	38	

**Load Switching Capabilities and Characteristics**

On-state resistance $T_j = 25^\circ\text{C}$ , $I_L = 0.5\text{ A}$ $T_j = 125^\circ\text{C}$	$R_{ON}$	-	150 270	200 320	m $\Omega$
Turn-on time to 90% $V_{OUT}$ $R_L = 47\ \Omega$ , $V_{IN} = 0$ to 10 V	$t_{on}$	-	50	100	
Turn-off time to 10% $V_{OUT}$ $R_L = 47\ \Omega$ , $V_{IN} = 10$ to 0 V	$t_{off}$	-	75	150	
Slew rate on 10 to 30% $V_{OUT}$ , $R_L = 47\ \Omega$ , $V_{bb} = 15\text{ V}$	$dV/dt_{on}$	-	1	2	V/ $\mu\text{s}$
Slew rate off 70 to 40% $V_{OUT}$ , $R_L = 47\ \Omega$ , $V_{bb} = 15\text{ V}$	$-dV/dt_{off}$	-	1	2	

<sup>1</sup> Device on 50mm\*50mm\*1.5mm epoxy PCB FR4 with 6 cm<sup>2</sup> (one layer, 70 $\mu\text{m}$  thick) copper area for drain connection. PCB is vertical without blown air.

**Electrical Characteristics**

Parameter at $T_j = -25...125^\circ\text{C}$ , $V_{bb} = 15...30\text{V}$ , unless otherwise specified	Symbol	Values			Unit
		min.	typ.	max.	

**Operating Parameters**

Operating voltage	$V_{bb(\text{on})}$	11	-	45	V
Undervoltage shutdown	$V_{bb(\text{under})}$	7	-	10.5	
Undervoltage restart	$V_{bb(\text{u rst})}$	-	-	11	
Undervoltage hysteresis $\Delta V_{bb(\text{under})} = V_{bb(\text{u rst})} - V_{bb(\text{under})}$	$\Delta V_{bb(\text{under})}$	-	0.5	-	
Standby current	$I_{bb(\text{off})}$	-	50	150	$\mu\text{A}$
Operating current <sup>1)</sup>	$I_{\text{GND}}$	-	5	12	mA
Leakage output current (included in $I_{bb(\text{off})}$ ) $V_{\text{IN}} = \text{low}$ , each channel	$I_{\text{L(off)}}$	-	5	10	$\mu\text{A}$

**Protection Functions<sup>2)</sup>**

Initial peak short circuit current limit $T_j = -25^\circ\text{C}$ , $V_{bb} = 30\text{V}$ , $t_m = 700\ \mu\text{s}$ $T_j = 25^\circ\text{C}$ $T_j = 125^\circ\text{C}$	$I_{\text{L(SCP)}}$	- - 0.7	- 1.4 -	1.9 - -	A
Repetitive short circuit current limit $T_j = T_{jt}$ (see timing diagrams)	$I_{\text{L(SCr)}}$	-	1.1	-	
Output clamp (inductive load switch off) at $V_{\text{OUT}} = V_{bb} - V_{\text{ON(CL)}}$ ,	$V_{\text{ON(CL)}}$	47	53	60	V
Overvoltage protection <sup>3)</sup>	$V_{bb(\text{AZ})}$	47	-	-	
Thermal overload trip temperature <sup>4)</sup>	$T_{jt}$	135	-	-	$^\circ\text{C}$
Thermal hysteresis	$\Delta T_{jt}$	-	10	-	K

<sup>1)</sup>contains all input currents

<sup>2)</sup>Integrated protection functions are designed to prevent IC destruction under fault conditions described in the data sheet. Fault conditions are considered as "outside" normal operating range. Protection functions are not designed for continuous repetitive operation.

<sup>3)</sup> see also  $V_{\text{ON(CL)}}$  in circuit diagram on page 10

<sup>4)</sup> higher operating temperature at normal function for each channel available

**Electrical Characteristics**

Parameter at $T_j = -25...125^\circ\text{C}$ , $V_{bb}=15...30\text{V}$ , unless otherwise specified	Symbol	Values			Unit
		min.	typ.	max.	
<b>Input</b>					
Continuous input voltage <sup>1)</sup>	$V_{IN}$	-10	-	$V_{bb}$	V
Input turn-on threshold voltage CMOS <sup>2)</sup>	$V_{IN(T+)}$	-	-	2.2	
Input turn-off threshold voltage CMOS <sup>2)</sup>	$V_{IN(T-)}$	0.8	-	-	
Input turn-on threshold voltage $V_{bb}/2$ <sup>2)</sup>	$V_{IN(T+)}$	-	-	$V_{bb}/2+1$	
Input turn-off threshold voltage $V_{bb}/2$ <sup>2)</sup>	$V_{IN(T-)}$	$V_{bb}/2-1$	-	-	
Input threshold hysteresis	$\Delta V_{IN(T)}$	-	0.3	-	
Off state input current CMOS ( each channel )	$I_{IN(off)}$	8	-	-	$\mu\text{A}$
On state input current CMOS ( each channel )	$I_{IN(on)}$	-	-	70	
Off state input current $V_{bb}/2$ ( each channel )	$I_{IN(off)}$	80	-	-	
On state input current $V_{bb}/2$ ( each channel )	$I_{IN(on)}$	-	-	260	
Input delay time at switch on $V_{bb}$	$t_{d(V_{bbon})}$	150	340	-	$\mu\text{s}$
Input resistance (see page 10)	$R_i$	2	3	4	$\text{k}\Omega$
Internal pull down resistor at LS-pin <sup>3)</sup>	$R_{LS}$	300	800	-	

**Diagnostic Characteristics**

Common diagnostic output current <sup>4)</sup> ( overtemperature of any channel ) $T_j = 135^\circ\text{C}$	$I_{diag}$	2	3	4	$\text{mA}$
Common diagnostic output leakage current	$I_{diag(high)}$	-	-	2	$\mu\text{A}$

<sup>1)</sup>At  $V_{IN} > V_{bb}$ , the input current is not allowed to exceed  $\pm 5\text{ mA}$ .

<sup>2)</sup>see page 9

<sup>3)</sup>LS-pin is connected to  $V_{bb}$

<sup>4)</sup>see page 10

**Electrical Characteristics**

Parameter at $T_j = -25\dots125^\circ\text{C}$ , $V_{bb} = 15\dots30\text{V}$ , unless otherwise specified	Symbol	Values			Unit
		min.	typ.	max.	
<b>Reverse Battery</b>					
Reverse battery voltage <sup>1)</sup>	$-V_{bb}$				V
$R_{GND} = 0 \Omega$		-	-	1	
$R_{GND} = 150 \Omega$		-	-	45	
Diode forward on voltage	$-V_{ON}$	-	-	1.2	
$I_F = 1.25 \text{ A}$ , $V_{IN} = \text{low}$ , each channel					

<sup>1</sup>defined by  $P_{tot}$



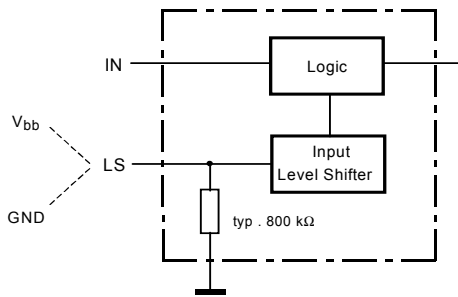
**Truth table for common diagnostic pin ( LED-driver ):**

	Input level	Output level	Diagnostic
Normal operation	L	L	L
	H	H	L
Short circuit to GND	L	L	L
	H	L	L
Undervoltage	L	L	L
	H	L	L
Overtemperature	L	L	L
	H	L	H <sup>1)</sup>

L = no diagnostic output current

H = diagnostic output current typ. 2 mA (see page 7)

**Programmable input:**



**Functional description LS-Pin:**

With using the LS-pin it is possible to change the input turn-on and -off threshold voltage between CMOS and half supply voltage level.

Therefore you have either to connect the LS-pin to GND ( state 1 ) or to supply voltage ( state 2 ). If the LS-pin is not connected the input threshold voltages are automatically at CMOS level, caused by an internal pull down to GND with typ. 800kΩ ( see circuit ).

State 1: LS-Pin to GND

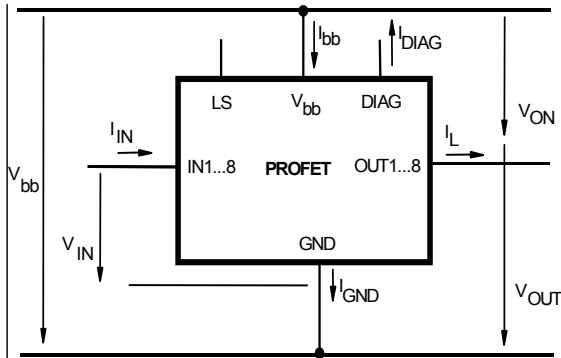
CMOS - Input level

State 2: LS-Pin to supply voltage

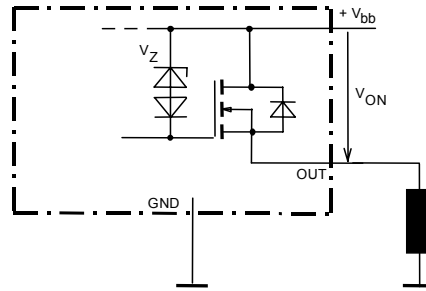
$V_{bb}/2$  - Input level

<sup>1</sup>toggeling with restart

**Terms**  
each channel

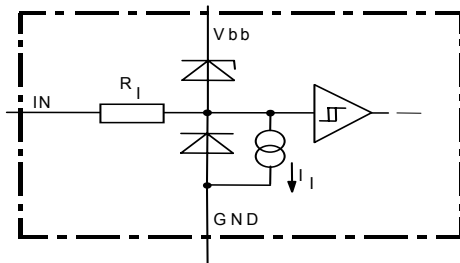


**Inductive and overvoltage output clamp**  
each channel



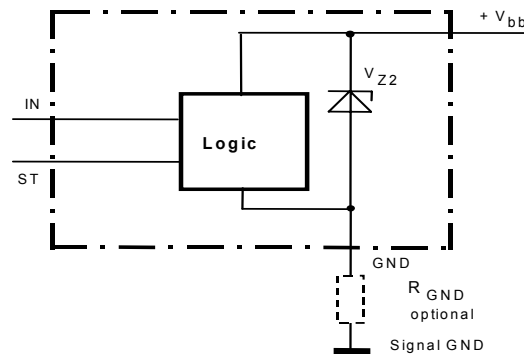
$V_{ON}$  clamped to 47 V min.

**Input circuit (ESD protection)**  
each channel



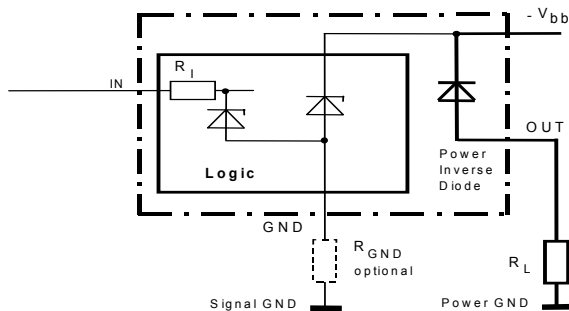
The use of ESD zener diodes as voltage clamp at DC conditions is not recommended

**Overvoltage protection of logic part**



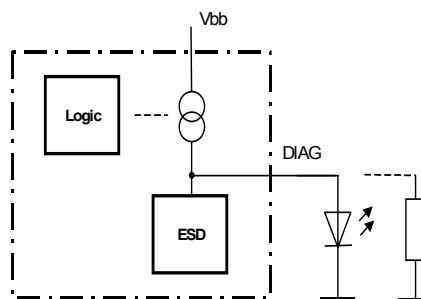
$V_{Z2}=V_{bb(AZ)}=47$  V min.,  
 $R_I=3$  k $\Omega$  typ.,  $R_{GND}=150\Omega$

**Reverse battery protection**  
each channel



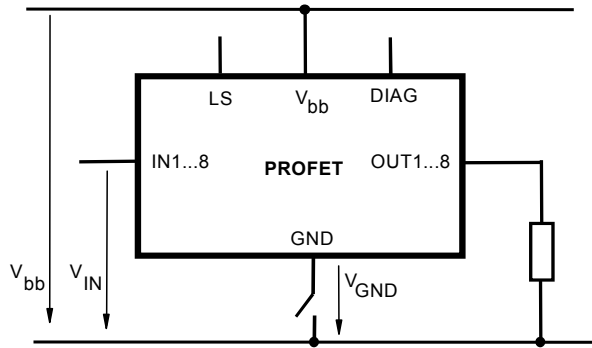
$R_{GND}=150\Omega$ ,  $R_I=3k\Omega$  typ.,  
Temperature protection is not active during inverse current

**Common diagnostic output**

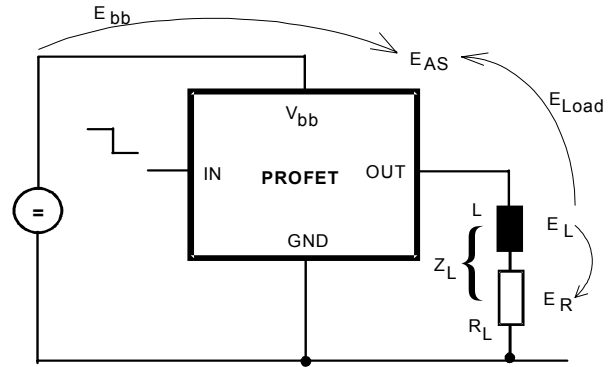


Output current typ. 2 mA

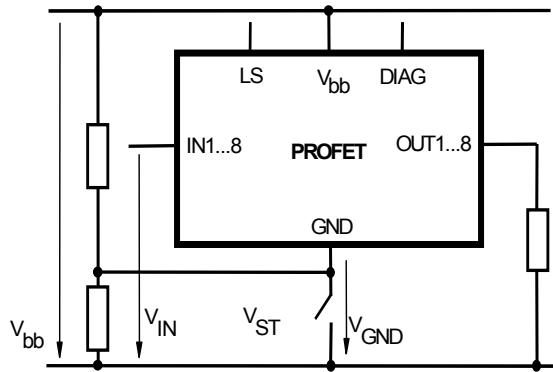
**GND disconnect**



**Inductive Load switch-off energy dissipation, each channel**



**GND disconnect with GND pull up**



Energy stored in load inductance:  $E_L = \frac{1}{2} * L * I_L^2$

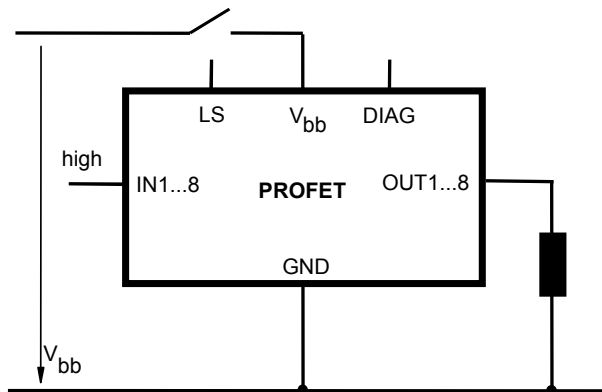
While demagnetizing load inductance, the energy dissipated in PROFET is

$$E_{AS} = E_{bb} + E_L - E_R = V_{ON(CL)} * i_L(t) dt,$$

with an approximate solution for  $R_L > 0\Omega$ :

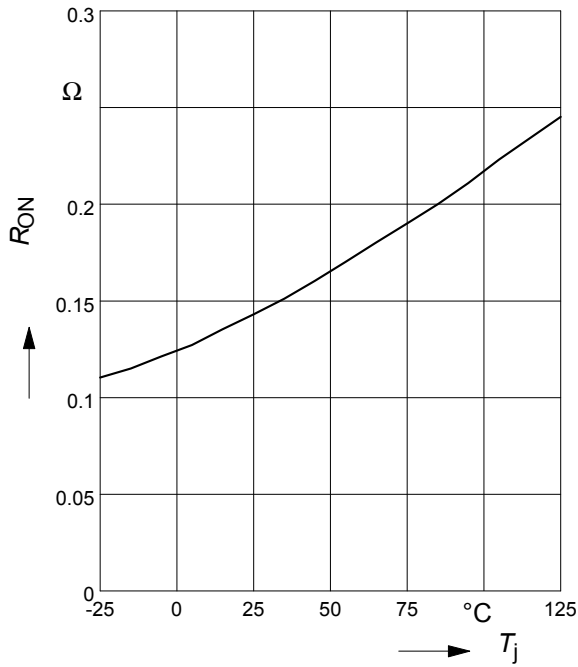
$$E_{AS} = \frac{I_L * L}{2 * R_L} * (V_{bb} + |V_{OUT(CL)}|) * \ln\left(1 + \frac{I_L * R_L}{|V_{OUT(CL)}|}\right)$$

**V<sub>bb</sub> disconnect with charged inductive load**



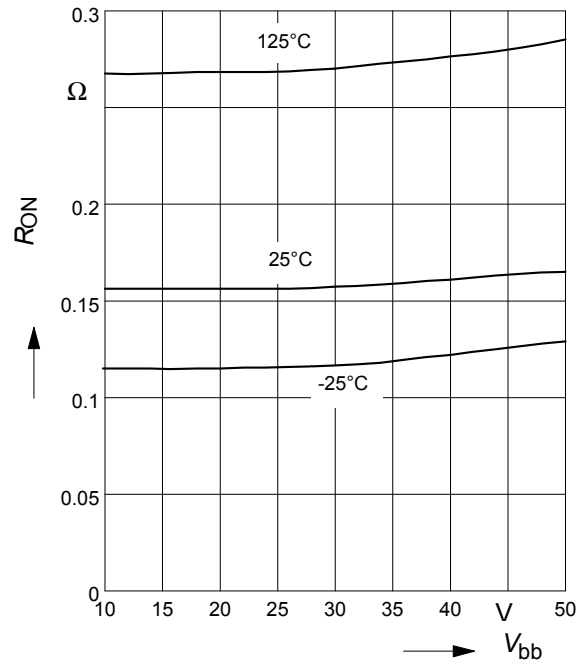
**Typ. on-state resistance**

$R_{ON} = f(T_j)$ ;  $V_{bb} = 15V$ ;  $V_{in} = \text{high}$



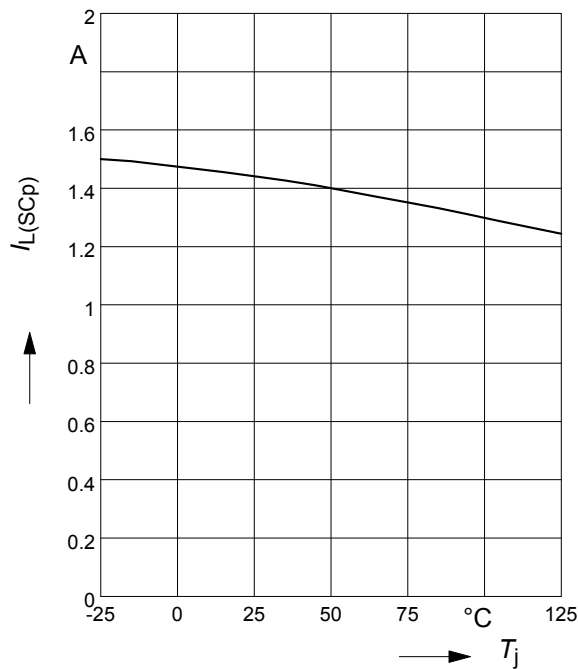
**Typ. on-state resistance**

$R_{ON} = f(V_{bb})$ ;  $I_L = 0.5A$ ;  $V_{in} = \text{high}$



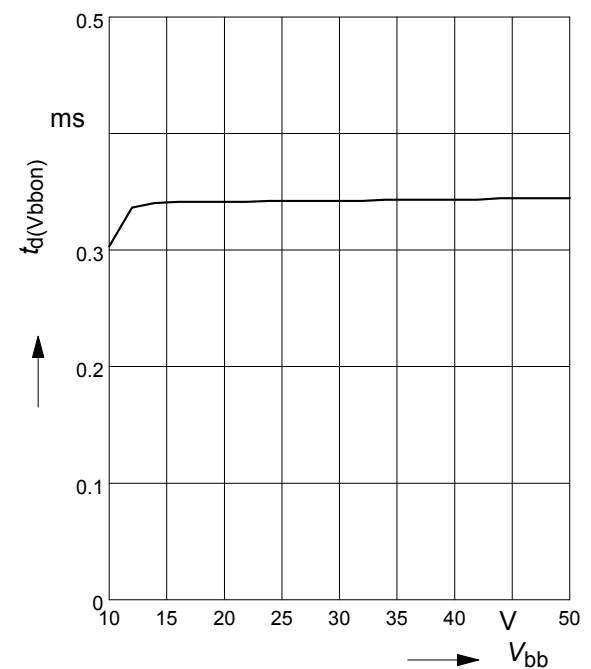
**Typ. initial peak short circuit current limit**

$I_{L(SCP)} = f(T_j)$ ;  $V_{bb} = 24V$



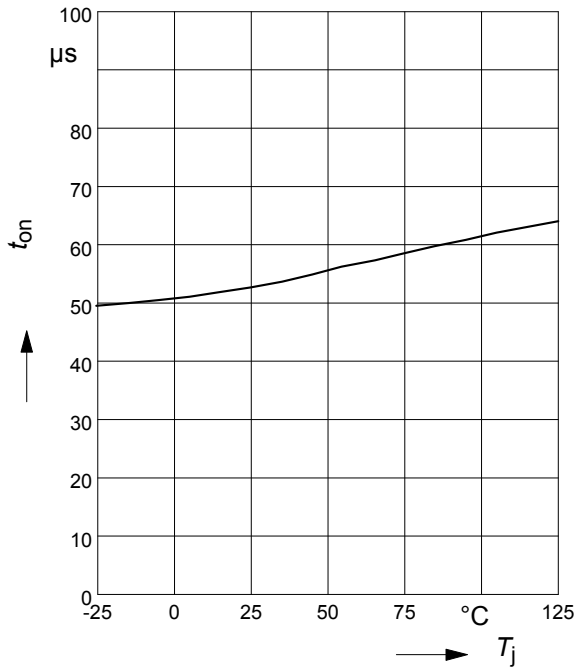
**Typ. input delay time at switch on  $V_{bb}$**

$t_{d(Vbbon)} = f(V_{bb})$ ;  $T_j = -25...125$   $^{\circ}C$



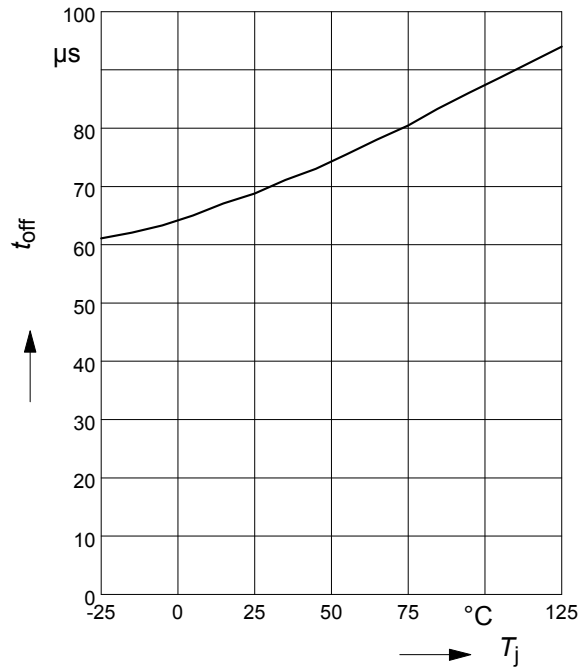
**Typ. turn on time**

$t_{on} = f(T_j); R_L = 47\Omega$



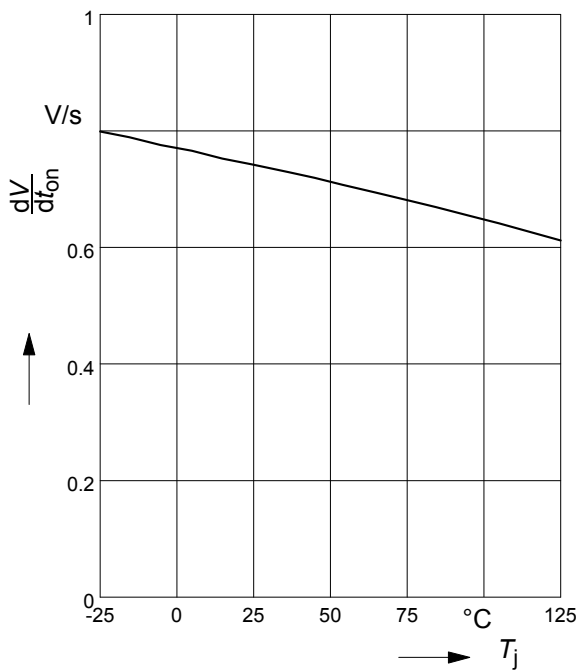
**Typ. turn off time**

$t_{off} = f(T_j); R_L = 47\Omega$



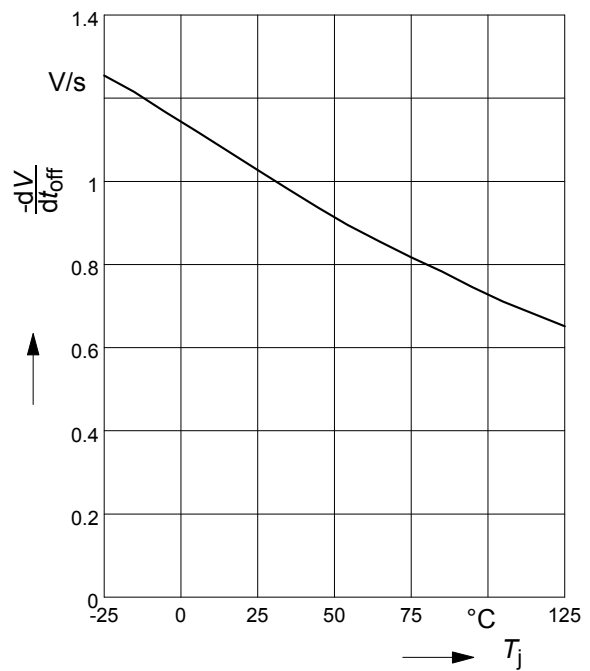
**Typ. slew rate on**

$dV/dt_{on} = f(T_j); R_L = 47\Omega, V_{bb} = 15V$



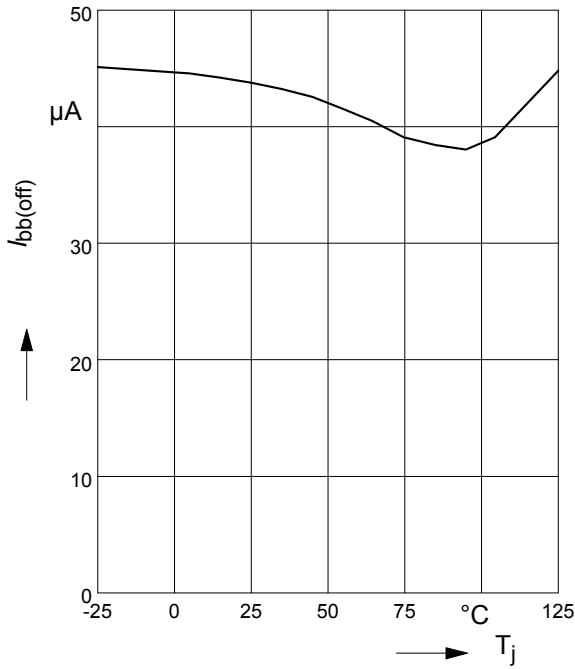
**Typ. slew rate off**

$dV/dt_{off} = f(T_j); R_L = 47\Omega, V_{bb} = 15V$



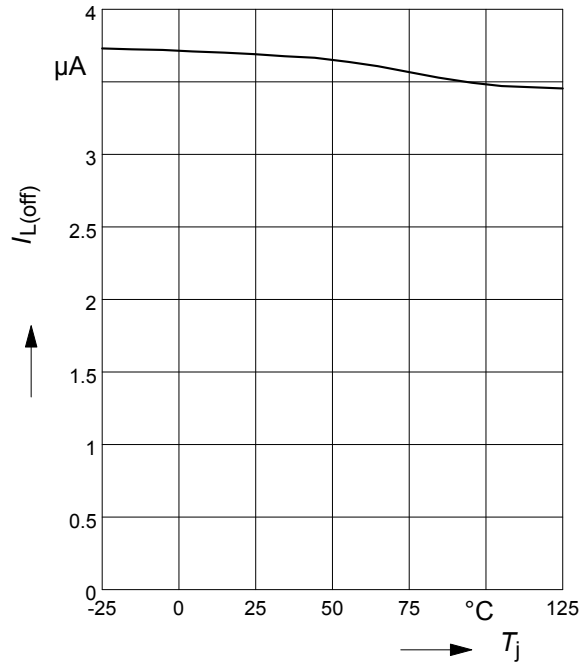
**Typ. standby current**

$I_{bb(off)} = f(T_j)$ ;  $V_{bb} = 30V$ ;  $V_{IN} = \text{low}$



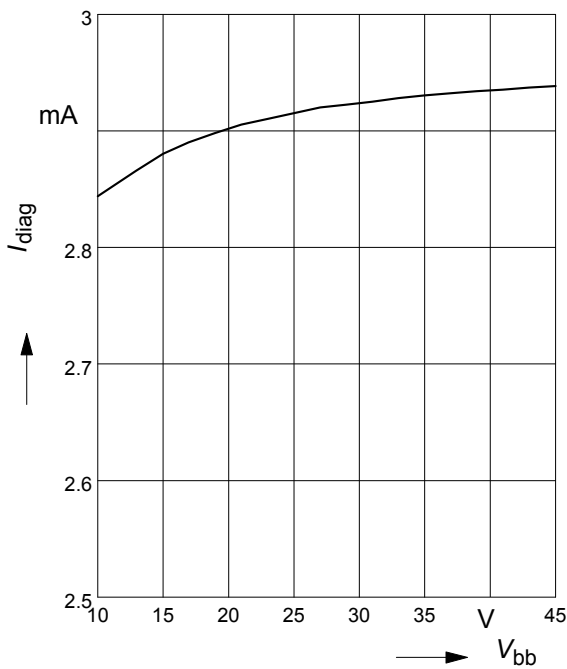
**Typ. leakage current**

$I_{L(off)} = f(T_j)$ ;  $V_{bb} = 30V$ ;  $V_{IN} = \text{low}$



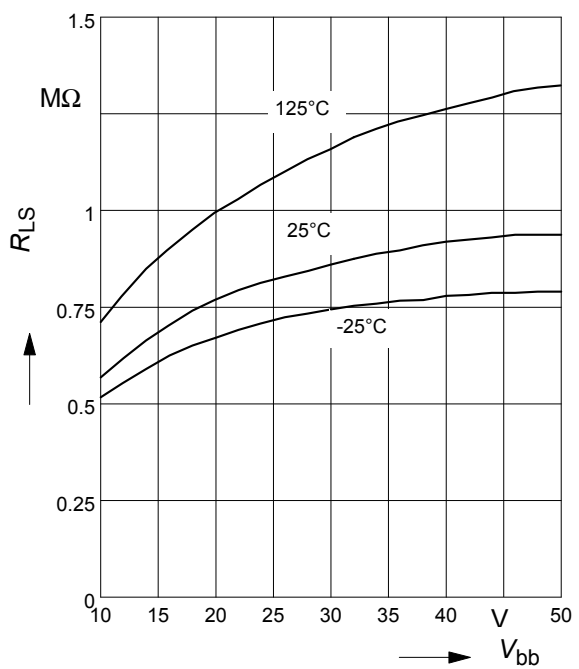
**Typ. common diagnostic output current**

$I_{diag} = f(V_{bb})$ ;  $T_j = 135^\circ C$



**Typ. internal pull down resistor at LS-pin**

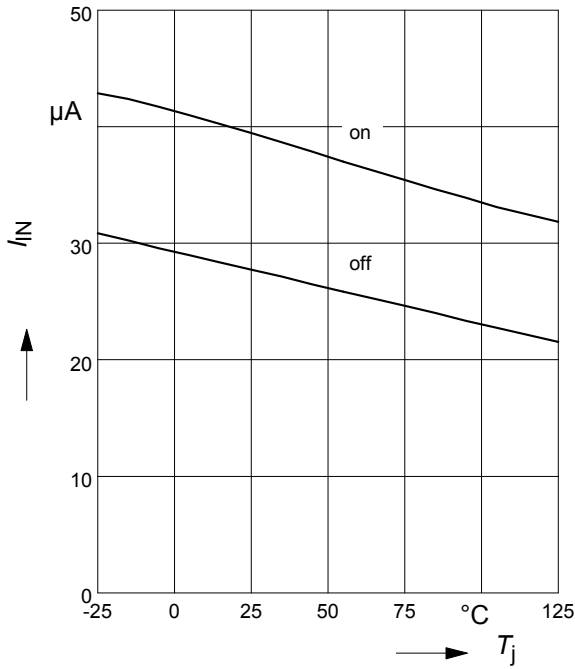
$R_{LS} = f(V_{bb})$ ;  $V_{LS} = V_{bb}$



**Typ. input current @ CMOS level**

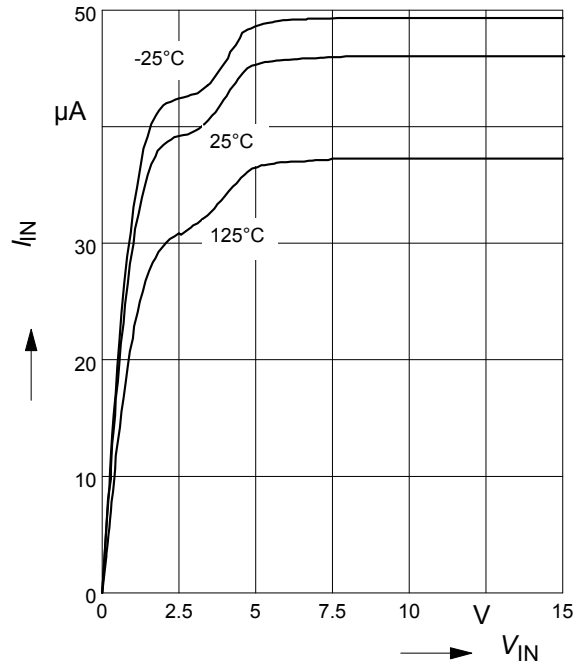
$I_{IN(on/off)} = f(T_j)$ ;  $V_{bb} = 15V$ ;  $V_{IN} = \text{low/high}$

$V_{INlow} \leq 0,8V$ ;  $V_{INhigh} = 2,2V$



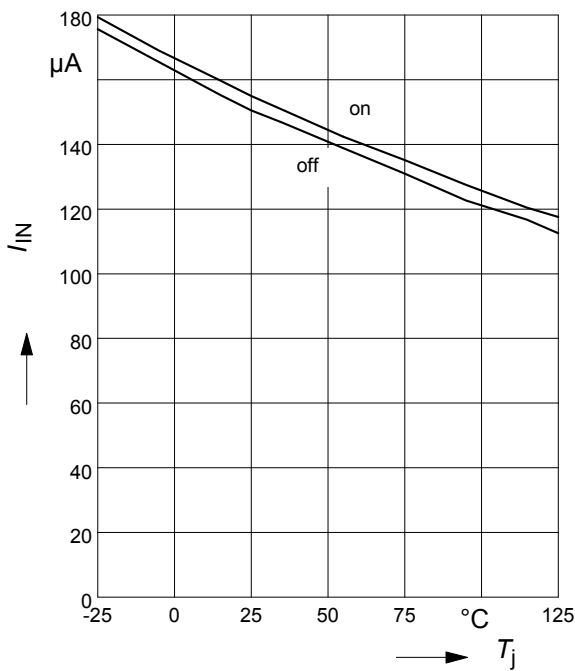
**Typ. input current @ CMOS level**

$I_{IN} = f(V_{IN})$ ;  $V_{bb} = 15V$



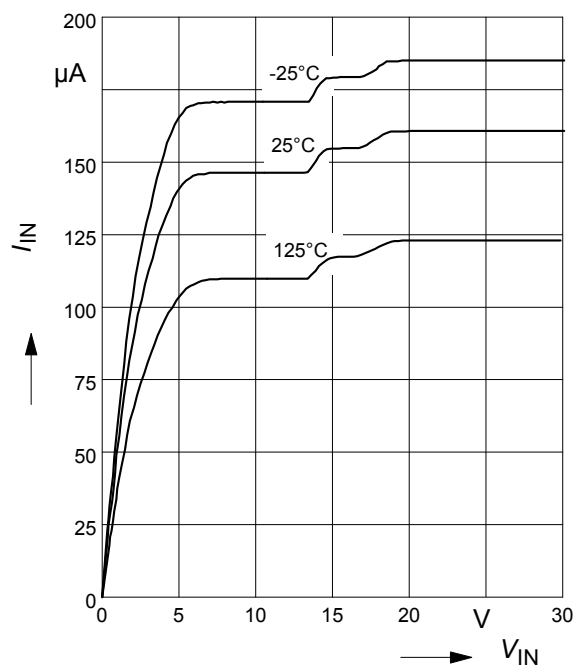
**Typ. input current @ V<sub>bb</sub>/2 level**

$I_{IN(on/off)} = f(T_j)$ ;  $V_{bb} = 30V$ ;  $V_{IN} = \text{low/high}$



**Typ. input current @ V<sub>bb</sub>/2 level**

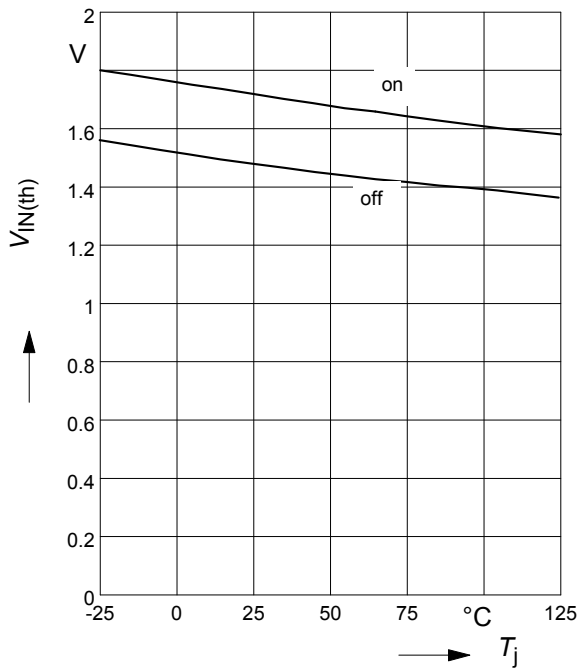
$I_{IN} = f(V_{IN})$ ;  $V_{bb} = 30 V$



**Typ. input threshold voltage**

**@ CMOS level**

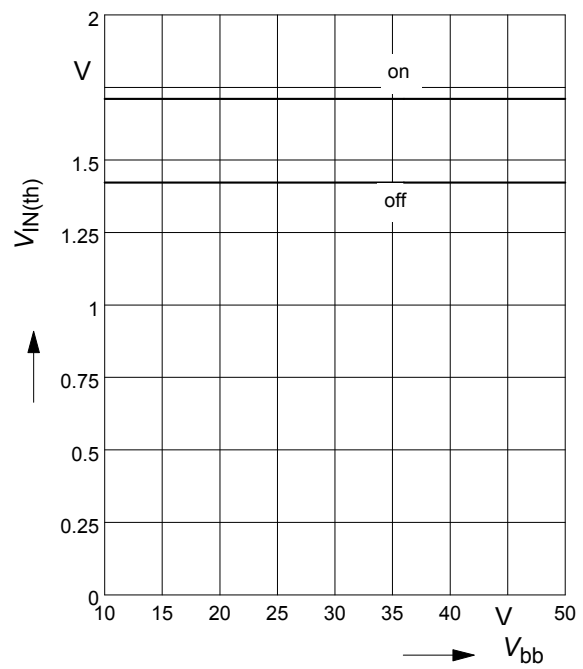
$V_{IN(th)} = f(T_j) ; V_{bb} = 15V$



**Typ. input threshold voltage**

**@ CMOS level**

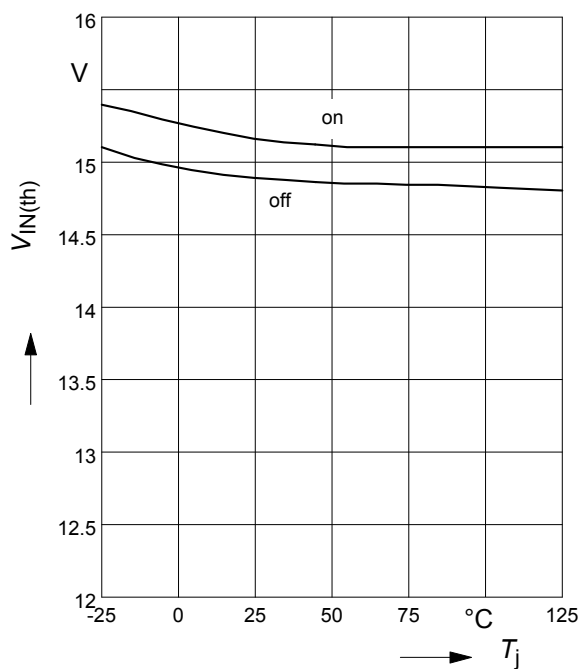
$V_{IN(th)} = f(V_{bb}) ; T_j = 25^{\circ}C$



**Typ. input threshold voltage**

**@ V<sub>bb</sub>/2 level**

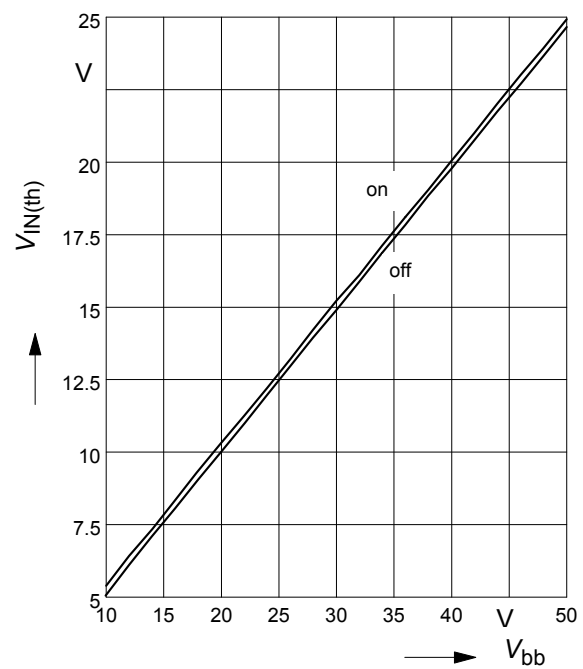
$V_{IN(th)} = f(T_j) ; V_{bb} = 30V$



**Typ. input threshold voltage**

**@ V<sub>bb</sub>/2 level: LS-pin connected to V<sub>bb</sub>**

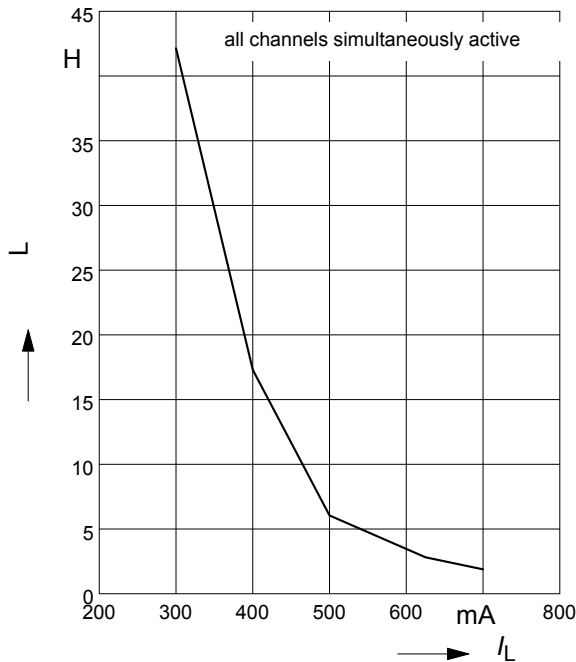
$V_{IN(th)} = f(V_{bb}) ; T_j = 25^{\circ}C$





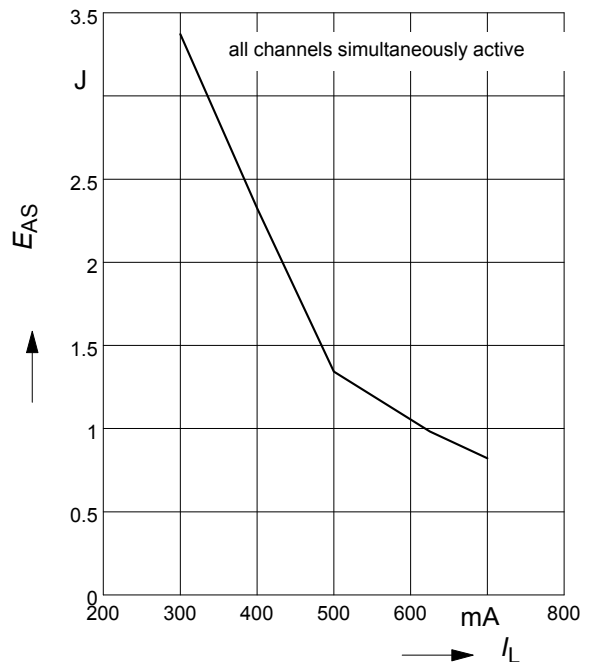
**Maximum allowable load inductance for a single switch off, calculated**

$L = f(I_L); T_{jstart}=125^{\circ}C, V_{bb}=24V, R_L=0\Omega$



**Maximum allowable inductive switch-off energy, single pulse**

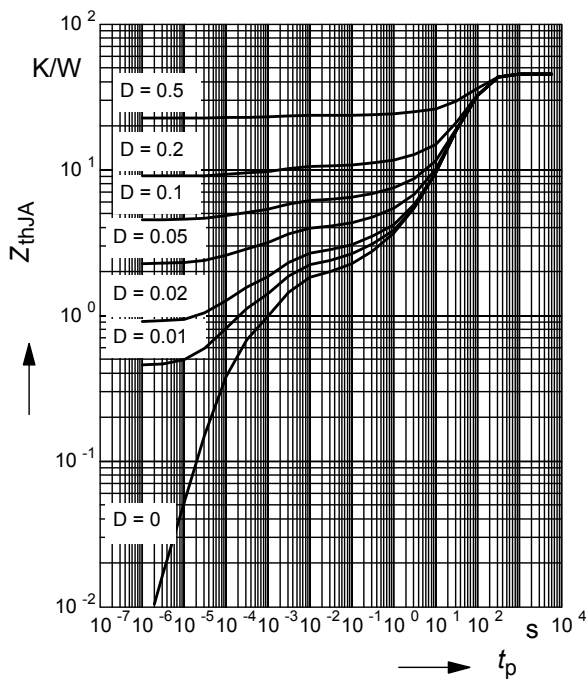
$E_{AS} = f(I_L); T_{jstart} = 125^{\circ}C, V_{bb} = 24V$



**Typ. transient thermal impedance**

$Z_{thJA}=f(t_p)$  @ min. footprint

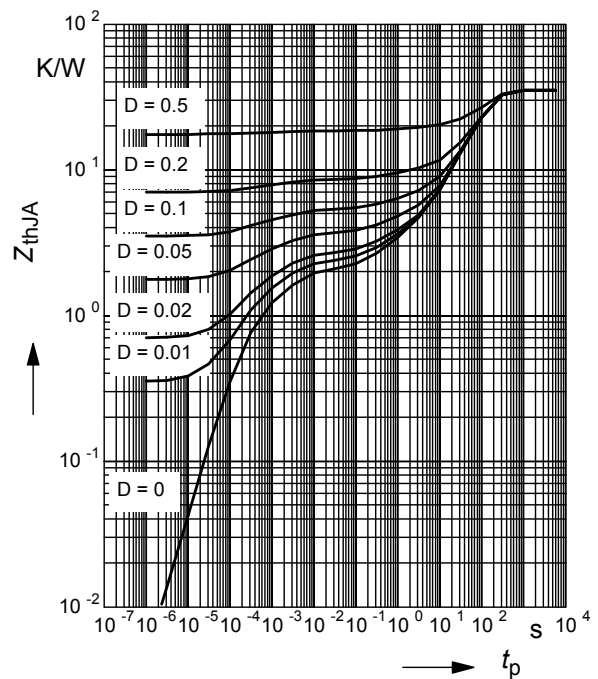
Parameter:  $D=t_p/T$



**Typ. transient thermal impedance**

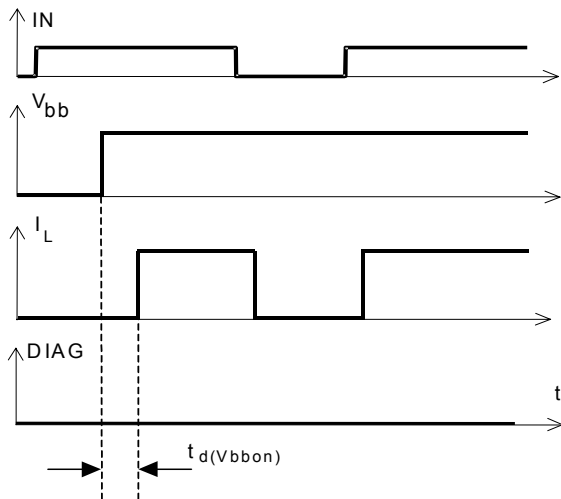
$Z_{thJA}=f(t_p)$  @ 6cm<sup>2</sup> heatsink area

Parameter:  $D=t_p/T$

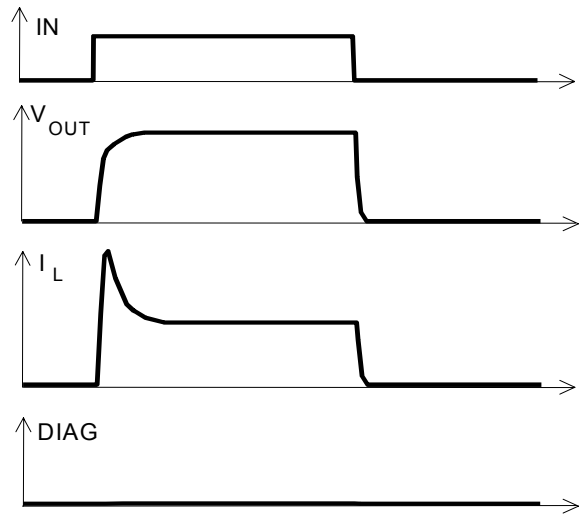


**Timing diagrams**

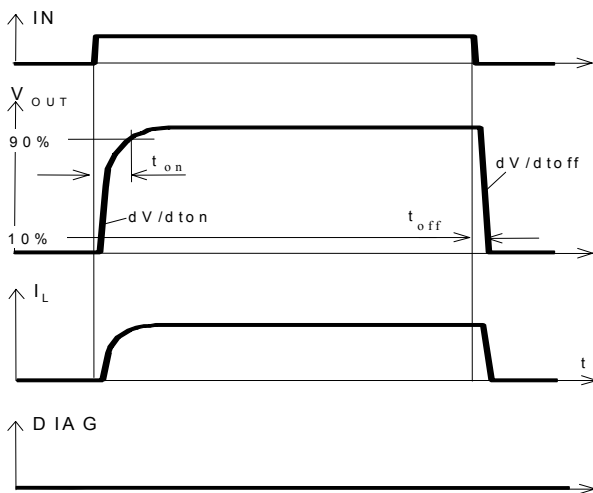
**Figure 1a: V<sub>bb</sub> turn on:**



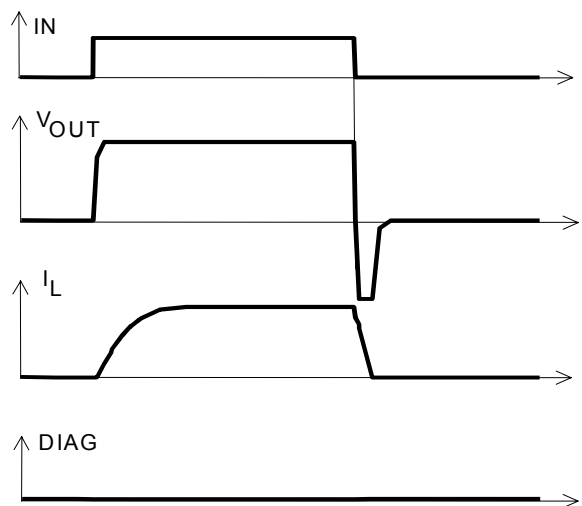
**Figure 2b: Switching a lamp**



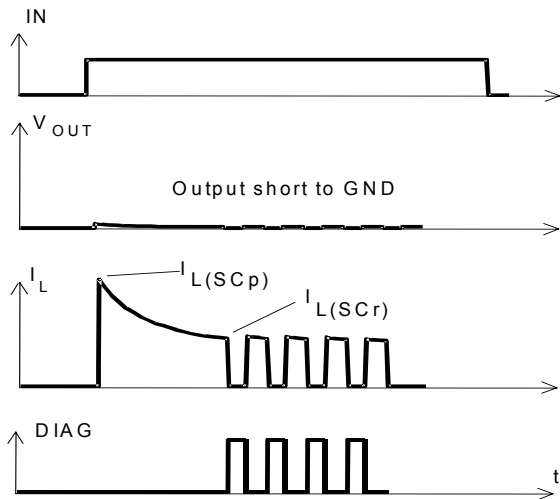
**Figure 2a: Switching a resistive load, turn-on/off time and slew rate definition**



**Figure 2c: Switching an inductive load**

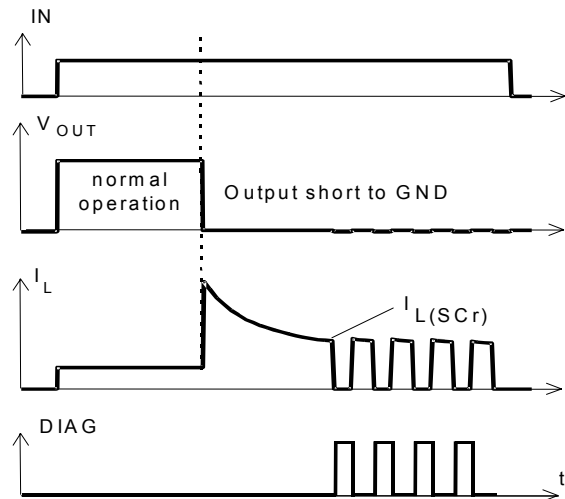


**Figure 3a:** Turn on into short circuit, shut down by overtemperature, restart by cooling

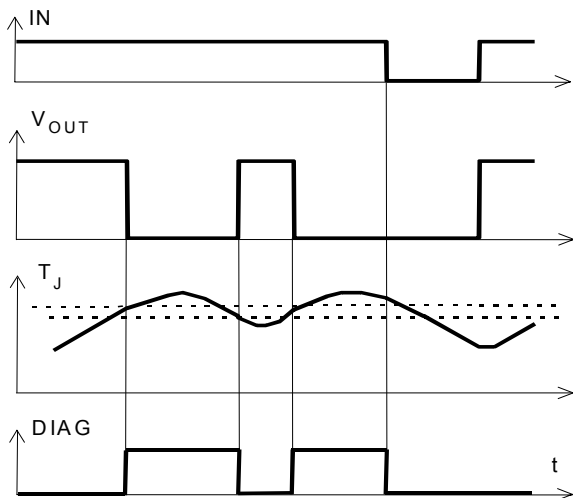


Heating up of the chip may require several milliseconds, depending on external conditions.

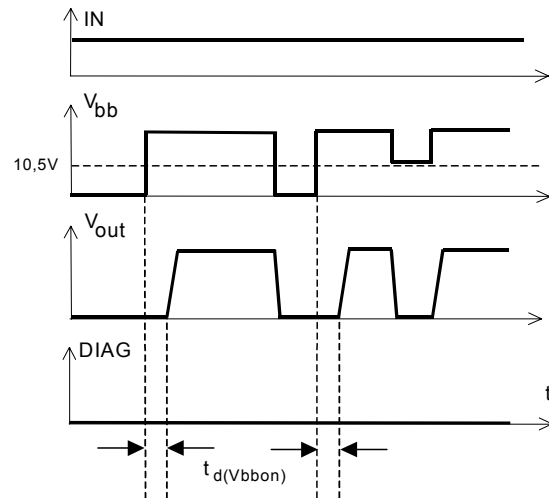
**Figure 3b:** Short circuit in on-state shut down by overtemperature, restart by cooling



**Figure 4:** Overtemperature:  
Reset if  $T_j < T_{jt}$



**Figure 5:** Undervoltage shutdown and restart

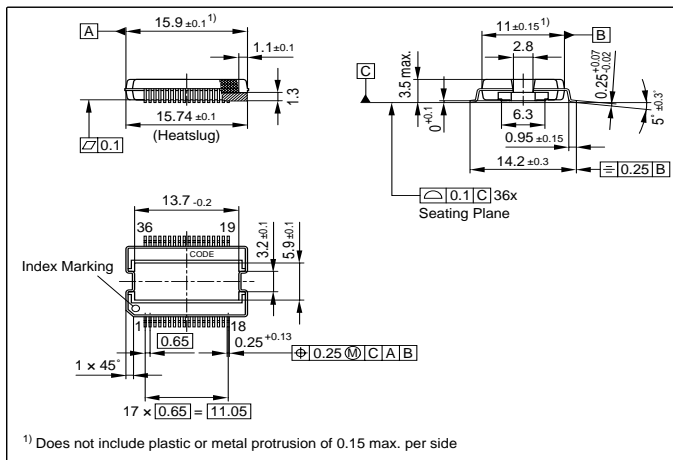


## Package and ordering code

all dimensions in mm

Ordering code:

ITS 4880 R	SP000219527
------------	-------------



**Published by**  
**Infineon Technologies AG,**  
**St.-Martin-Strasse 53,**  
**D-81669 München**  
**© Infineon Technologies AG 2001**  
**All Rights Reserved.**

### Attention please!

The information herein is given to describe certain components and shall not be considered as a guarantee of characteristics.

Terms of delivery and rights to technical change reserved.

We hereby disclaim any and all warranties, including but not limited to warranties of non-infringement, regarding circuits, descriptions and charts stated herein.

Infineon Technologies is an approved CECC manufacturer.

### Information

For further information on technology, delivery terms and conditions and prices please contact your nearest Infineon Technologies Office in Germany or our Infineon Technologies Representatives worldwide (see address list).

### Warnings

Due to technical requirements components may contain dangerous substances. For information on the types in question please contact your nearest Infineon Technologies Office.

Infineon Technologies Components may only be used in life-support devices or systems with the express written approval of Infineon Technologies, if a failure of such components can reasonably be expected to cause the failure of that life-support device or system, or to affect the safety or effectiveness of that device or system. Life support devices or systems are intended to be implanted in the human body, or to support and/or maintain and sustain and/or protect human life. If they fail, it is reasonable to assume that the health of the user or other persons may be endangered.