

Solid-state Twin Timers

H3CR-F

DIN 48 × 48-mm Twin Timers

- Wide power supply ranges of 100 to 240 VAC and 48 to 125 VDC respectively.
- ON- and OFF-times can be set independently and so combinations of long ON- or OFF-time and short OFF- or ON-time settings are possible.
- Fourteen time ranges from 0.05 s to 30 h or from 1.2 s to 300 h depending on the model to be used.
- Models with a flicker ON start or flicker OFF start are available.
- Easy sequence checks through instantaneous outputs for a zero set value at any time range.
- Length, when panel-mounted with a Socket, of 80 mm or less.
- 11-pin and 8-pin models are available.



Model Number Structure

Model Number Legend

H3CR - F -
 1 2 3 4 5

1. Classification

F: Twin timers

2. Configuration

None: 11-pin socket

8: 8-pin socket

3. Twin Timer Mode

None: Flicker OFF start

N: Flicker ON start

4. Time Range

None: 0.05 s to 30 h models

300: 1.2 s to 300 h models

5. Supply Voltage

100-240AC: 100 to 240 VAC

24AC/DC: 24 VAC/VDC

12DC: 12 VDC

48-125DC: 48 to 125 VDC

Ordering Information

List of Models

Operating modes	Supply voltage	0.05 s to 30 h models		1.2 s to 300 h models	
		11-pin models	8-pin models	11-pin models	8-pin models
Flicker OFF start	100 to 240 VAC	H3CR-F 100-240AC	H3CR-F8 100-240AC	H3CR-F-300 100-240AC	H3CR-F8-300 100-240AC
	24 VAC/DC	H3CR-F 24AC/DC	H3CR-F8 24AC/DC	H3CR-F-300 24AC/DC	H3CR-F8-300 24AC/DC
	12 VDC	H3CR-F 12DC	H3CR-F8 12DC	H3CR-F-300 12DC	H3CR-F8-300 12DC
	48 to 125 VDC	H3CR-F 48-125DC	H3CR-F8 48-125DC	H3CR-F-300 48-125DC	H3CR-F8-300 48-125DC
Flicker ON start	100 to 240 VAC	H3CR-FN 100-240AC	H3CR-F8N 100-240AC	H3CR-FN-300 100-240AC	H3CR-F8N-300 100-240AC
	24 VAC/DC	H3CR-FN 24AC/DC	H3CR-F8N 24AC/DC	H3CR-FN-300 24AC/DC	H3CR-F8N-300 24AC/DC
	12 VDC	H3CR-FN 12DC	H3CR-F8N 12DC	H3CR-FN-300 12DC	H3CR-F8N-300 12DC
	48 to 125 VDC	H3CR-FN 48-125DC	H3CR-F8N 48-125DC	H3CR-FN-300 48-125DC	H3CR-F8N-300 48-125DC

Note: Specify both the model number and supply voltage when ordering.

Example: H3CR-F 100-240AC

Supply voltage

■ Accessories (Order Separately)

Name/specifications		Models
Flush Mounting Adapter		Y92F-30 Y92F-73 Y92F-74
Mounting Track	50 cm (l) × 7.3 mm (t)	PFP-50N
	1 m (l) × 7.3 mm (t)	PFP-100N
	1 m (l) × 16 mm (t)	PFP-100N2
End Plate		PFP-M
Spacer		PFP-S
Protective Cover		Y92A-48B
Track Mounting/ Front Connecting Socket	8-pin	P2CF-08
	8-pin, finger safe type	P2CF-08-E
	11-pin	P2CF-11
	11-pin, finger safe type	P2CF-11-E
Back Connecting Socket	8-pin	P3G-08
	8-pin, finger safe type	P3G-08 with Y92A-48G (See note 1)
	11-pin	P3GA-11
	11-pin, finger safe type	P3GA-11 with Y92A-48G (See note 1)
Hold-down Clip (See note 2)	For PL08 and PL11 Sockets	Y92H-7
	For PF085A Socket	Y92H-8

Note: 1. Y92A-48G is a finger safe terminal cover which is attached to the P3G-08 or P3GA-11 Socket.

2. Hold-down Clips are sold in sets of two.

Specifications

■ General

Item	H3CR-F	H3CR-F8	H3CR-FN	H3CR-F8N
Operating mode	Flicker OFF start		Flicker ON start	
Pin type	11-pin	8-pin	11-pin	8-pin
Operating/Reset method	Time-limit operation/Time-limit reset or self-reset			
Output type	Relay output (DPDT)			
Mounting method	DIN track mounting, surface mounting, and flush mounting			
Approved standards	UL508, CSA C22.2 No.14, NK, Lloyds Conforms to EN61812-1 and IEC60664-1 (VDE0110) 4kV/2. Output category according to EN60947-5-1.			

■ Time Ranges

0.05 s to 30 h Models

Time unit	s (sec)	×10 s (10 sec)	min (min)	h (hrs)
Setting	1.2	0.05 to 1.2	1.2 to 12	0.12 to 1.2
	3	0.3 to 3	3 to 30	0.3 to 3
	12	1.2 to 12	12 to 120	1.2 to 12
	30	3 to 30	30 to 300	3 to 30

Note: Instantaneous output is available at any time range. To obtain instantaneous output, set to below 0.

1.2 s to 300 h Models

Time unit	×10 s (10 sec)	×10 min (10 min)	h (hrs)	×10 h (10 hrs)
Setting	1.2	1.2 to 12	1.2 to 12	1.2 to 12
	3	3 to 30	3 to 30	3 to 30
	12	12 to 120	12 to 120	12 to 120
	30	30 to 300	30 to 300	30 to 300

Note: Instantaneous output is available at any time range. To obtain instantaneous output, set to below 0.

■ Ratings

Rated supply voltage (See notes 1, 2, and 3.)	100 to 240 VAC (50/60 Hz), 12 VDC, 24 VAC/DC (50/60 Hz), 48 to 125 VDC
Operating voltage range	85% to 110% of rated supply voltage; 90% to 110% with 12-VDC models
Power reset	Minimum power-opening time: 0.1 s
Power consumption	100 to 240 VAC: approx. 10 VA (2.1 W) at 240 VAC 24 VAC/VDC: approx. 2 VA (1.7 W) at 24 VAC approx. 1 W at 24 VDC 48 to 125 VDC: approx. 1.5 W at 125 VDC 12 VDC: approx. 1 W at 12 VDC
Control outputs	Contact output: 5 A at 250 VAC/30 VDC, resistive load ($\cos\phi = 1$)

Note: 1. A power supply with a ripple of 20% max. (single-phase power supply with full-wave rectification) can be used with each DC Model.

2. Do not use an inverter output as the power supply. Refer to *Safety Precautions for All Timers* for details.

3. Refer to *Safety Precautions for All Timers* when using the Timer together with a 2-wire AC proximity sensor.

■ Characteristics

Accuracy of operating time	±0.2% FS max. (±0.2% FS ±10 ms max. in ranges of 1.2 and 3 s)	
Setting error	±5% FS ±50 ms max.	
Reset time	0.1 s max.	
Reset voltage	10% max. of rated voltage	
Influence of voltage	±0.2% FS max. (±0.2% FS ±10 ms max. in ranges of 1.2 and 3 s)	
Influence of temperature	±1% FS max. (±1% FS ±10 ms max. in ranges of 1.2 and 3s)	
Insulation resistance	100 MΩ min. (at 500 VDC)	
Dielectric strength	2,000 VAC, 50/60 Hz for 1 min (between current-carrying metal parts and exposed non-current-carrying metal parts) 2,000 VAC, 50/60 Hz for 1 min (between control output terminals and operating circuit) 2,000 VAC, 50/60 Hz for 1 min (between contacts of different polarities) 1,000 VAC, 50/60 Hz for 1 min (between contacts not located next to each other)	
Impulse withstand voltage	3 kV (between power terminals) for 100 to 240 VAC, 48 to 125 VDC 1 kV for 12 VDC, 24 VAC/DC 4.5 kV (between current-carrying terminal and exposed non-current-carrying metal parts) for 100 to 240 VAC, 48 to 125 VDC 1.5 kV for 12 VDC, 24 VAC/DC	
Noise immunity	±1.5 kV (between power terminals), square-wave noise by noise simulator (pulse width: 100 ns/1 μs, 1-ns rise) ±400 V for 12 VDC	
Static immunity	Malfunction: 8 kV Destruction: 15 kV	
Vibration resistance	Destruction: 10 to 55 Hz with 0.75-mm single amplitude for 2 hrs each in three directions Malfunction: 10 to 55 Hz with 0.5-mm single amplitude for 10 min each in three directions	
Shock resistance	Destruction: 980 m/s ² three times each in six directions Malfunction: 98 m/s ² three times each in six directions	
Ambient temperature	Operating: -10°C to 55°C (with no icing) Storage: -25°C to 65°C (with no icing)	
Ambient humidity	Operating: 35% to 85%	
Life expectancy	Mechanical: 20 million operations min. (under no load at 1,800 operations/h) Electrical: 100,000 operations min. (5 A at 250 VAC, resistive load at 1,800 operations/h) (See note)	
EMC	(EMI)	EN61812-1
	Emission Enclosure:	EN55011 Group 1 class A
	Emission AC Mains:	EN55011 Group 1 class A
	(EMS)	EN61812-1
	Immunity ESD:	IEC61000-4-2: 6 kV contact discharge (level 3) 8 kV air discharge (level 3)
	Immunity RF-interference from AM Radio Waves:	IEC61000-4-3: 10 V/m (80 MHz to 1 GHz) (level 3)
	Immunity RF-interference from Pulse-modulated Radio Waves:	IEC61000-4-3: 10 V/m (900±5 MHz) (level 3)
	Immunity Conducted Disturbance:	IEC61000-4-6: 10 V (0.15 to 80 MHz) (level 3)
	Immunity Burst:	IEC61000-4-4: 2 kV power-line (level 3)
	Immunity Surge:	IEC61000-4-5: 2 kV I/O signal-line (level 4) 1 kV line to line (level 3) 2 kV line to ground (level 3)
Case color	Light Gray (Munsell 5Y7/1)	
Degree of protection	IP40 (panel surface)	
Weight	Approx. 100 g	

Note: Refer to the *Life-test Curve*.

Life-test Curve

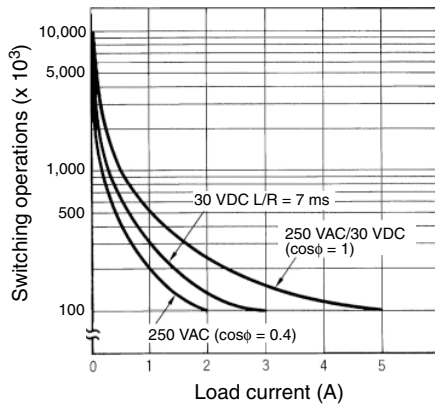

Reference: A maximum current of 0.15 A can be switched at 125 VDC (cosφ = 1) and a maximum current of 0.1 A can be switched if L/R is 7 ms. In both cases, a life of 100,000 operations can be expected. The minimum applicable load is 10 mA at 5 VDC (failure level: P).

Connections

Block Diagrams

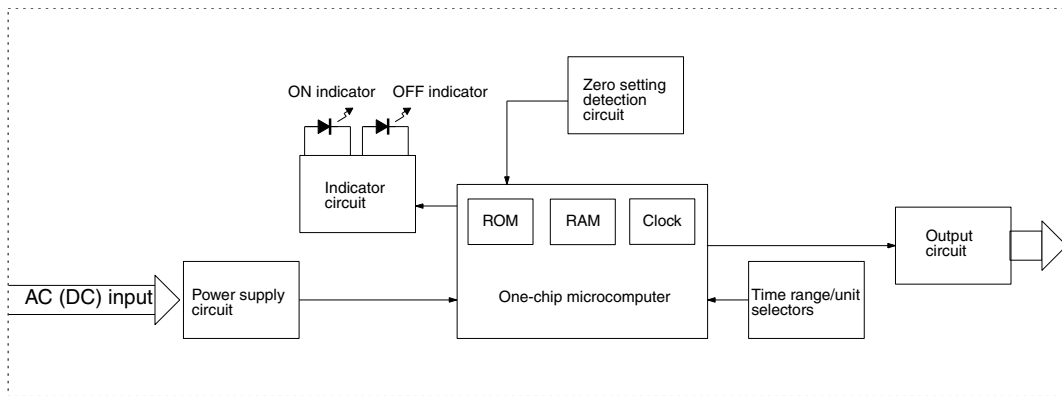

I/O Functions

Inputs	---	
Outputs	Control output	Outputs are turned ON/OFF according to the time set by the ON- and OFF-time setting knob.

Terminal Arrangement

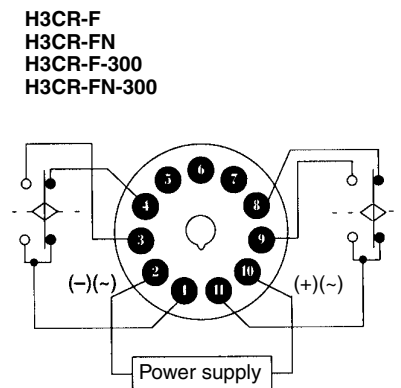
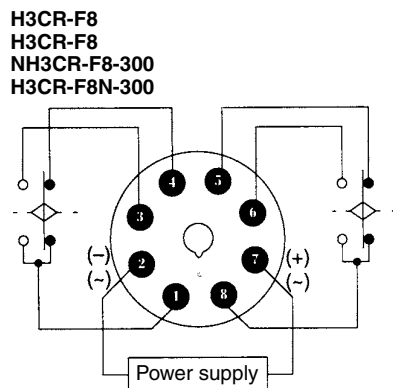

Note: Leave terminals 5, 6, and 7 open. Do not use them as relay terminals.

Operation

■ Timing Chart

ton: ON set time
toff: OFF set time

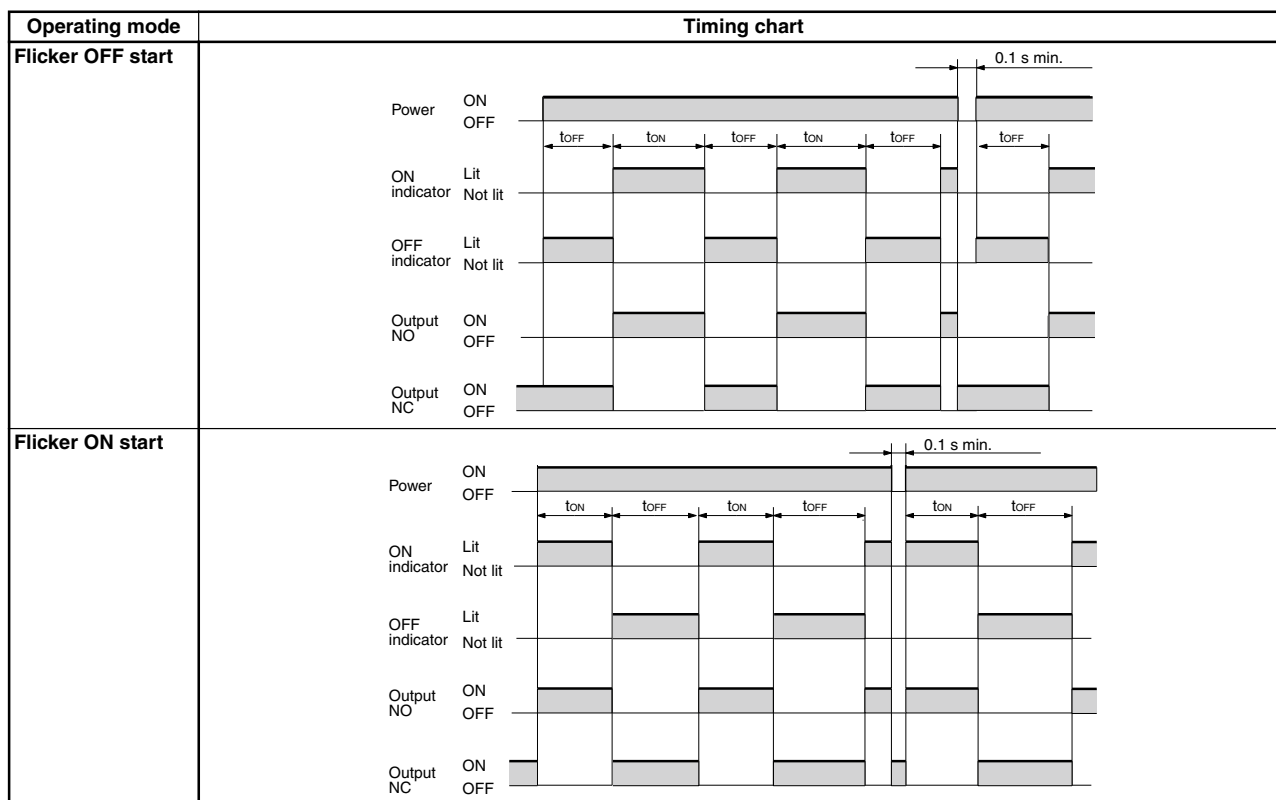

- Note:**
1. The reset time requires a minimum of 0.1 s.
 2. When power is supplied in flicker ON start mode, the OFF indicator lights momentarily. This, however, has no effect on the performance of the Timer.

Nomenclature

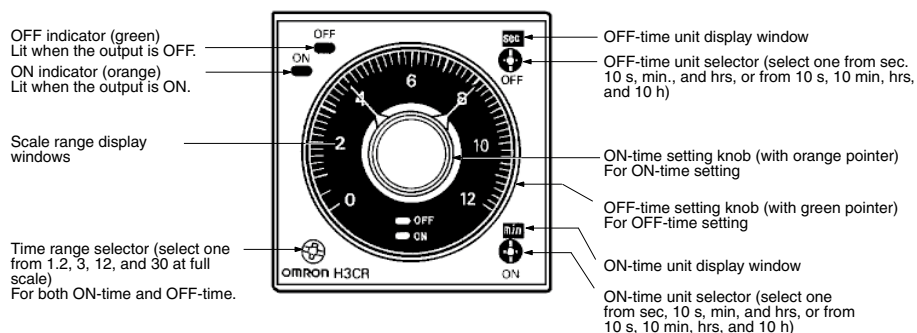

Dimensions

Note: All units are in millimeters unless otherwise indicated.

H3CR-F
H3CR-FN
H3CR-F-300
H3CR-FN-300

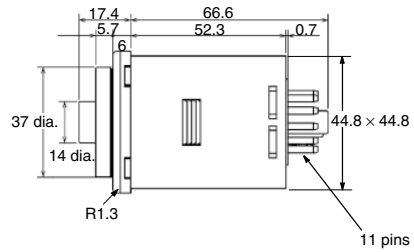
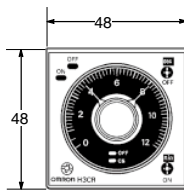
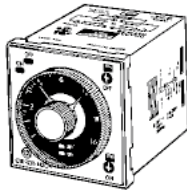

H3CR-F8
H3CR-F8N
H3CR-F8-300
H3CR-F8N-300

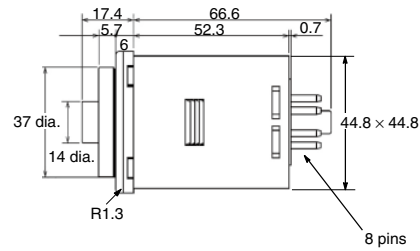
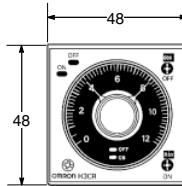
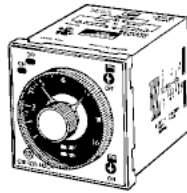

Dimensions with Front Connecting Socket P2CF-08-□/ P2CF-11-□

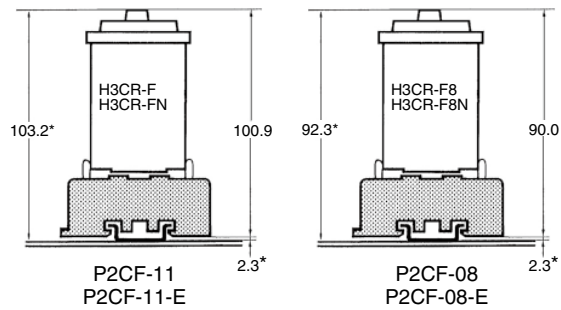

Dimensions with Back Connecting Socket P3G-08/P3GA-11

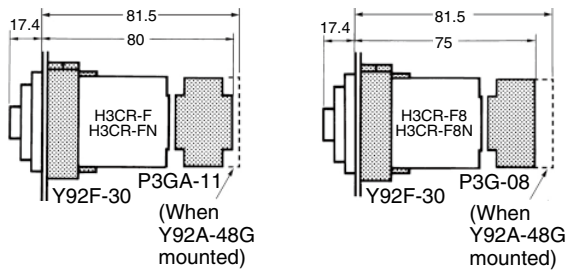

*These dimensions vary with the kind of DIN track (reference value).

ALL DIMENSIONS SHOWN ARE IN MILLIMETERS.

To convert millimeters into inches, multiply by 0.03937. To convert grams into ounces, multiply by 0.03527.

In the interest of product improvement, specifications are subject to change without notice.

H3CR-G

DIN 48 × 48-mm Star-delta Timer

- A wide star-time range (up to 120 seconds) and star-delta transfer time range (up to 0.5 seconds).



Model Number Structure

Model Number Legend

H3CR - G 8 □ L □
 1 2 3 4 5

1. Classification

G: Star-delta timer

2. Configuration

8: 8-pin socket

3. Outputs

None: Star-delta operation contact

E: Star-delta operation contact and instantaneous contact

4. Dimensions

L: Long-body model

5. Supply Voltage

100-120AC: 100 to 120 VAC

200-240AC: 200 to 240 VAC

Ordering Information

List of Models

Outputs	Supply voltage	8-pin models
Time-limit contact	100 to 120 VAC	H3CR-G8L 100-120AC
	200 to 240 VAC	H3CR-G8L 200-240AC
Time-limit contact and instantaneous contact	100 to 120 VAC	H3CR-G8EL 100-120AC
	200 to 240 VAC	H3CR-G8EL 200-240AC

Note: Specify both the model number and supply voltage when ordering.

Example: H3CR-G8L 100-120AC

Supply voltage

Accessories (Order Separately)

Name/specifications		Models
Flush Mounting Adapter		Y92F-30
		Y92F-70
		Y92F-71
Mounting Track	50 cm (l) × 7.3 mm (t)	PFP-50N
	1 m (l) × 7.3 mm (t)	PFP-100N
	1 m (l) × 16 mm (t)	PFP-100N2
End Plate		PFP-M
Spacer		PFP-S
Protective Cover		Y92A-48B
Track Mounting/ Front Connecting Socket	8-pin	P2CF-08
	8-pin, finger safe type	P2CF-08-E
Back Connecting Socket	8-pin	P3G-08
	8-pin, finger safe type	P3G-08 with Y92A-48G (See note 1)
Time Setting Ring	Setting a specific time	Y92S-27
	Limiting the setting range	Y92S-28
Panel Cover (See note 2)	Light gray (5Y7/1)	Y92P-48GL
	Black (N1.5)	Y92P-48GB
	Medium gray (5Y5/1)	Y92P-48GM
Hold-down Clip (See note 3)	For PL08 and PL11 Sockets	Y92H-1
	For PF085A Socket	Y92H-2

Note: 1. Y92A-48G is a finger safe terminal cover which is attached to the P3G-08 Socket.

2. The Time Setting Ring and Panel Cover are sold together.

3. Hold-down Clips are sold in sets of two.

Specifications

■ General

Item	H3CR-G8L	H3CR-G8EL
Functions	Star-delta timer	Star-delta timer with instantaneous output
Pin type	8-pin	
Operating/Reset method	Time-limit operation/Self-reset	
Output type	Time-limit: SPST-NO (star operation circuit) SPST-NO (delta operation circuit)	Time-limit: SPST-NO (star operation circuit) SPST-NO (delta operation circuit) Instantaneous: SPST-NO
Mounting method	DIN track mounting, surface mounting, and flush mounting	
Approved standards	UL508, CSA C22.2 No.14, NK, Lloyds Conforms to EN61812-1 and IEC60664-1 (VDE0110) 4kV/2. Output category according to EN60947-5-1.	

■ Time Ranges

Time unit	Star operation time ranges	
Full scale setting	6	0.5 to 6 s
	12	1 to 12 s
	60	5 to 60 s
	120	10 to 120 s

Star-delta transfer time	Programmable at 0.05 s, 0.1 s, 0.25 s or 0.5 s
--------------------------	--

■ Ratings

Rated supply voltage (See notes 1 and 2.)	100 to 120 VAC (50/60 Hz), 200 to 240 VAC (50/60 Hz)
Operating voltage range	85% to 110% of rated supply voltage
Power reset	Minimum power-opening time: 0.5 s
Power consumption	100 to 120 VAC: approx. 6 VA (2.6 W) at 120 VAC 200 to 240 VAC: approx. 12 VA (3.0 W) at 240 VAC
Control outputs	Contact output: 5 A at 250 VAC/30 VDC, resistive load ($\cos\phi = 1$)

- Note:** 1. Do not use an inverter output as the power supply. Refer to *Safety Precautions for All Timers* for details.
2. Refer to *Safety Precautions for All Timers* when using the Timer together with a 2-wire AC proximity sensor.

■ Characteristics

Accuracy of operating time	±0.2% FS max.
Setting error	±5% FS ±50 ms max.
Accuracy of Star-delta transfer time	±25% FS + 5 ms max.
Reset voltage	10% max. of rated voltage
Influence of voltage	±0.2% FS max.
Influence of temperature	±1% FS max.
Insulation resistance	100 MΩ min. (at 500 VDC)
Dielectric strength	2,000 VAC, 50/60 Hz for 1 min (between current-carrying metal parts and exposed non-current-carrying metal parts) 2,000 VAC, 50/60 Hz for 1 min (between control output terminals and operating circuit) 2,000 VAC, 50/60 Hz for 1 min (between contacts of different polarities) 1,000 VAC, 50/60 Hz for 1 min (between contacts not located next to each other)
Impulse withstand voltage	3 kV (between power terminals) 4.5 kV (between current-carrying terminal and exposed non-current-carrying metal parts)
Noise immunity	±1.5 kV (between power terminals), square-wave noise by noise simulator (pulse width: 100 ns/1 μs, 1-ns rise)
Static immunity	Malfunction: 8 kV Destruction: 15 kV
Vibration resistance	Destruction: 10 to 55 Hz with 0.75-mm single amplitude for 2 hrs each in three directions Malfunction: 10 to 55 Hz with 0.5-mm single amplitude for 10 min each in three directions
Shock resistance	Destruction: 980 m/s ² three times each in six directions Malfunction: 294 m/s ² three times each in six directions
Ambient temperature	Operating: -10°C to 55°C (with no icing) Storage: -25°C to 65°C (with no icing)
Ambient humidity	Operating: 35% to 85%
Life expectancy	Mechanical: 20 million operations min. (under no load at 1,800 operations/h) Electrical: 100,000 operations min. (5 A at 250 VAC, resistive load at 1,800 operations/h) (See note)
EMC	(EMI) EN61812-1 Emission Enclosure: EN55011 Group 1 class A Emission AC Mains: EN55011 Group 1 class A (EMS) EN61812-1 Immunity ESD: IEC61000-4-2: 6 kV contact discharge (level 3) 8 kV air discharge (level 3) Immunity RF-interference from AM Radio Waves: IEC61000-4-3: 10 V/m (80 MHz to 1 GHz) (level 3) Immunity RF-interference from Pulse-modulated Radio Waves: IEC61000-4-3: 10 V/m (900±5 MHz) (level 3) Immunity Conducted Disturbance: IEC61000-4-6: 10 V (0.15 to 80 MHz) (level 3) Immunity Burst: IEC61000-4-4: 2 kV power-line (level 3) 2 kV I/O signal-line (level 4) Immunity Surge: IEC61000-4-5: 1 kV line to line (level 3) 2 kV line to ground (level 3)
Case color	Light Gray (Munsell 5Y7/1)
Degree of protection	IP40 (panel surface)
Weight	H3CR-G8L: approx. 110 g; H3CR-G8EL: approx. 130 g

Note: Refer to the *Life-test Curve*.

Life-test Curve

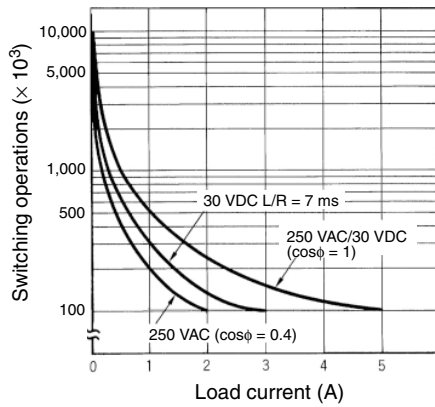

Reference: A maximum current of 0.15 A can be switched at 125 VDC ($\cos\phi = 1$) and a maximum current of 0.1 A can be switched if L/R is 7 ms. In both cases, a life of 100,000 operations can be expected. The minimum applicable load is 10 mA at 5 VDC (failure level: P).

Connections

Block Diagrams

H3CR-G8L

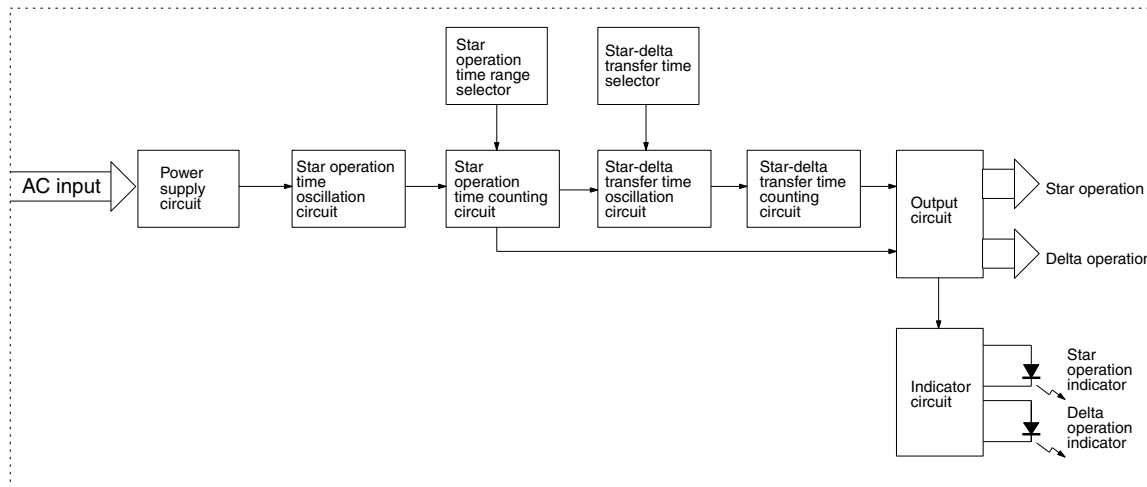

H3CR-G8EL

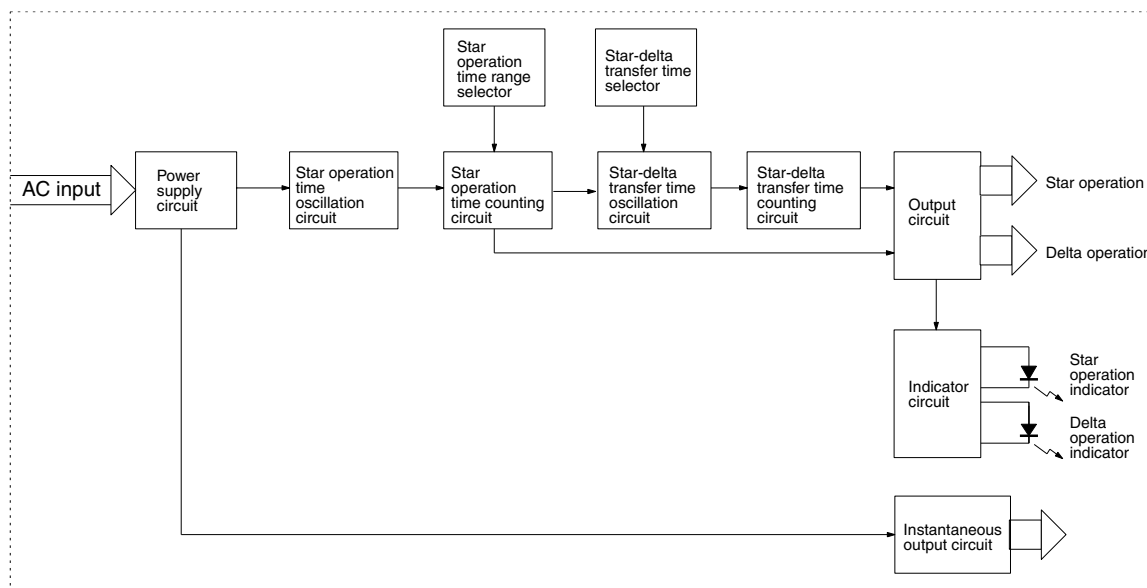

I/O Functions

Inputs	---	
Outputs	Control output	If the time reaches the value set with the time setting knob, the star operation output will be turned OFF and there will be delta operation output after the set star-delta transfer time has elapsed.

Terminal Arrangement

H3CR-G8L

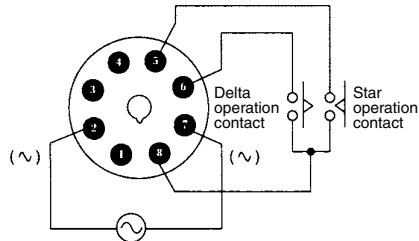

Note: Leave terminals 1, 3, and 4 open. Do not use them as relay terminals.

H3CR-G8EL

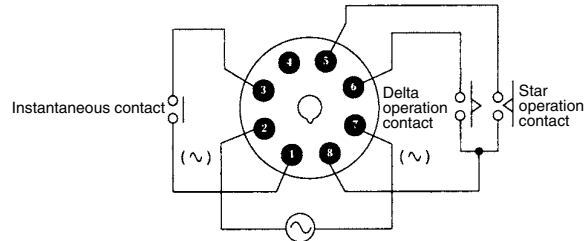

Note: Leave terminal 4 open. Do not use them as relay terminals.

Operation

Timing Chart

- t1: Star operation time setting
- t2: Star-delta transfer time

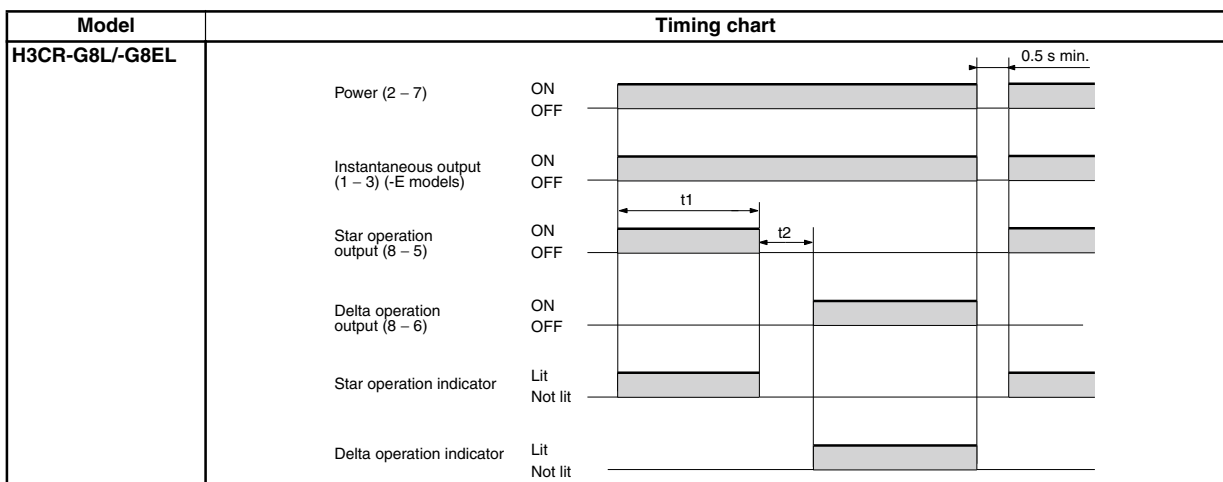

Nomenclature

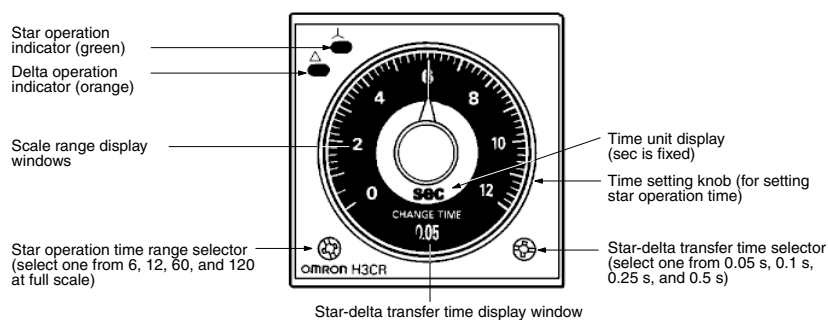

Dimensions

Note: All units are in millimeters unless otherwise indicated.

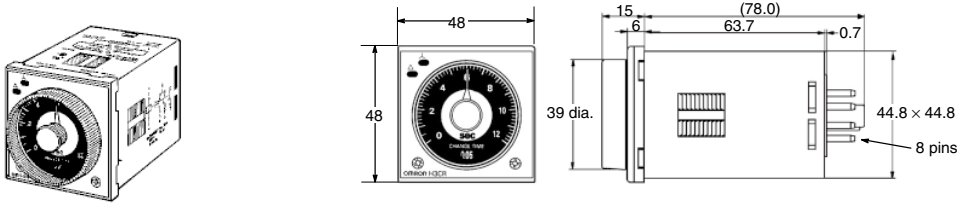

Dimensions with Set Ring

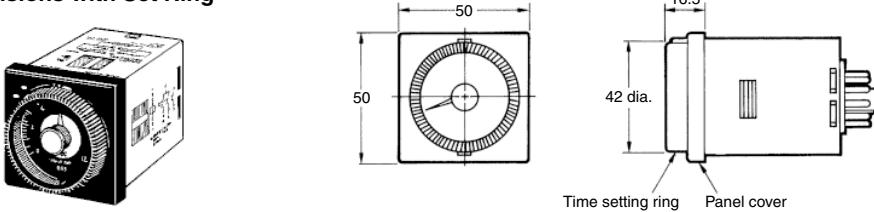

Dimensions with Front Connecting Socket P2CF-08-□

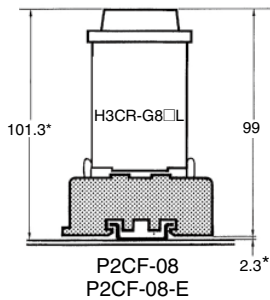

Dimensions with Back Connecting Socket P3G-08

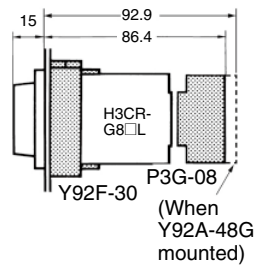

*These dimensions vary with the kind of DIN track (reference value).

ALL DIMENSIONS SHOWN ARE IN MILLIMETERS.
To convert millimeters into inches, multiply by 0.03937. To convert grams into ounces, multiply by 0.03527.

In the interest of product improvement, specifications are subject to change without notice.

H3CR-H

DIN 48 × 48-mm Power OFF-delay Timer

- Long power OFF-delay times;
S-series: up to 12 seconds,
M-series: up to 12 minutes.
- Models with forced-reset input are available.
- 11-pin and 8-pin models are available.



Model Number Structure

Model Number Legend

Note: This model number legend includes combinations that are not available. Before ordering, please check the *List of Models* on page 1 for availability.

H3CR - H L
 1 2 3 4 5 6

1. Classification

H: Power OFF-delay timer

2. Configuration

None: 11-pin socket

8: 8-pin socket

3. Input

None: Without reset input

R: With reset input

4. Dimensions

L: Long-body model

5. Supply Voltage

100-120AC: 100 to 120 VAC

200-240AC: 200 to 240 VAC

48DC: 48 VDC

100-125DC: 100 to 125 VDC

6. Time Range

S: 0.05 to 12 s

M: 0.05 to 12 min

List of Models

Input	Output	Supply voltage	S-series		M-series	
			11-pin models	8-pin models	11-pin models	8-pin models
Without reset input	DPDT	100 to 120 VAC	---	H3CR-H8L 100-120AC S	---	H3CR-H8L 100-120AC M
		200 to 240 VAC		H3CR-H8L 200-240AC S		H3CR-H8L 200-240AC M
		24 VAC/DC		H3CR-H8L 24AC/DC S		H3CR-H8L 24AC/DC M
		48 VDC		H3CR-H8L 48DC S		H3CR-H8L 48DC M
		100 to 125 VDC		H3CR-H8L 100-125DC S		H3CR-H8L 100-125DC M
With reset input		100 to 120 VAC	H3CR-HRL 100-120AC S	---	H3CR-HRL 100-120AC M	---
		200 to 240 VAC	H3CR-HRL 200-240AC S		H3CR-HRL 200-240AC M	
		24 VAC/DC	H3CR-HRL 24AC/DC S		H3CR-HRL 24AC/DC M	
		48 VDC	H3CR-HRL 48DC S		H3CR-HRL 48DC M	
		100 to 125 VDC	H3CR-HRL 100-125DC S		H3CR-HRL 100-125DC M	
	SPDT	100 to 120 VAC	---	H3CR-H8RL 100-120AC S	---	H3CR-H8RL 100-120AC M
		200 to 240 VAC		H3CR-H8RL 200-240AC S		H3CR-H8RL 200-240AC M
		24 VAC/DC		H3CR-H8RL 24AC/DC S		H3CR-H8RL 24AC/DC M
		48 VDC		H3CR-H8RL 48DC S		H3CR-H8RL 48DC M
		100 to 125 VDC		H3CR-H8RL 100-125DC S		H3CR-H8RL 100-125DC M

Note: Specify the model number, supply voltage, and time range (S or M) when ordering.

Example: H3CR-H8L 100-120AC S

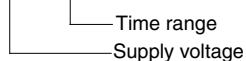

■ Accessories (Order Separately)

Name/specifications		Models
Flush Mounting Adapter		Y92F-30 Y92F-70 Y92F-71
Mounting Track	50 cm (l) × 7.3 mm (t)	PFP-50N
	1 m (l) × 7.3 mm (t)	PFP-100N
	1 m (l) × 16 mm (t)	PFP-100N2
End Plate		PFP-M
Spacer		PFP-S
Protective Cover		Y92A-48B
Track Mounting/ Front Connecting Socket	8-pin	P2CF-08
	8-pin, finger safe type	P2CF-08-E
	11-pin	P2CF-11
	11-pin, finger safe type	P2CF-11-E
Back Connecting Socket	8-pin	P3G-08
	8-pin, finger safe type	P3G-08 with Y92A-48G (See note 1)
	11-pin	P3GA-11
	11-pin, finger safe type	P3GA-11 with Y92A-48G (See note 1)
Hold-down Clip (See note 2)	For PL08 and PL11 Sockets	Y92H-1
	For PF085A Socket	Y92H-2

Note: 1. Y92A-48G is a finger safe terminal cover which is attached to the P3G-08 or P3GA-11 Socket.

2. Hold-down Clips are sold in sets of two.

Specifications

■ General

Item	H3CR-H8L	H3CR-H8RL	H3CR-H8L
Operating/Reset method	Instantaneous operation/Time-limit reset	Instantaneous operation/Time-limit reset/Forced reset	
Pin type	8-pin		11-pin
Input type	---	No-voltage	
Output type	Relay output (DPDT)	Relay output (SPDT)	Relay output (DPDT)
Mounting method	DIN track mounting, surface mounting, and flush mounting		
Approved standards	UL508, CSA C22.2 No.14, NK, Lloyds Conforms to EN61812-1 and IEC60664-1 (VDE0110) 4kV/2. Output category according to EN60947-5-1.		

■ Time Ranges

Time unit	S-series		M-series
	s (sec)		min (min)
Setting	0.6	0.05 to 0.6	
	1.2	0.12 to 1.2	
	6	0.6 to 6	
	12	1.2 to 12	
Min. power ON time	0.1 s min.	2 s min.	
Time-up operation repeat period	3 s min.		
Forced-reset repeat period	3 s min.		

Note: 1. If the above minimum power ON time is not secured, the H3CR may not operate. Be sure to secure the above minimum power ON time.

2. Do not use the Timer with a repeat period of less than 3 s. Doing so may result in abnormal heating or burning. Refer to *Safety Precautions (H3CR-H)* on page 8 for details.

■ Ratings

Rated supply voltage (See notes 1 and 2.)	100 to 120 VAC (50/60 Hz), 200 to 240 VAC (50/60 Hz), 24 VAC/VDC (50/60 Hz), 48 VDC, 100 to 125 VDC
Operating voltage range	85% to 110% of rated supply voltage
No-voltage input (See note 3.)	ON-impedance: 1 kΩ max. ON residual voltage: 1 V max. OFF impedance: 500 kΩ min.
Power consumption	100 to 120 VAC: approx. 0.23 VA (0.22 W) at 120 VAC 200 to 240 VAC: approx. 0.35 VA (0.3 W) at 240 VAC 24 VAC/DC: approx. 0.17 VA (0.15 W) at 24 VAC approx. 0.1 W at 24 VDC 48 VDC: approx. 0.18 W at 48 VDC 100 to 125 VDC: approx. 0.5 W at 125 VDC
Control outputs	Contact output: 5 A at 250 VAC/30 VDC, resistive load (cosφ = 1)

- Note:** 1. A power supply with a ripple of 20% max. (single-phase power supply with full-wave rectification) can be used with each DC Model.
2. Do not use an inverter output as the power supply. Refer to *Safety Precautions for All Timers* for details.
3. For contact input, use contacts which can adequately switch 1 mA at 5 V.

■ Characteristics

Accuracy of operating time	±0.2% FS max. (±0.2% FS ±10 ms max. in ranges of 0.6 and 1.2 s)
Setting error	±5% FS ±50 ms max.
Operation start voltage	30% max. of rated voltage
Influence of voltage	±0.2% FS max. (±0.2% FS ±10 ms max. in ranges of 0.6 and 1.2 s)
Influence of temperature	±1% FS max. (±1% FS ±10 ms max. in ranges of 0.6 and 1.2 s)
Insulation resistance	100 MΩ min. (at 500 VDC)
Dielectric strength	2,000 VAC, 50/60 Hz for 1 min (between current-carrying metal parts and exposed non-current-carrying metal parts) 2,000 VAC, 50/60 Hz for 1 min (between control output terminals and operating circuit) 2,000 VAC, 50/60 Hz for 1 min (between contacts of different polarities) 1,000 VAC, 50/60 Hz for 1 min (between contacts not located next to each other)
Impulse withstand voltage	3 kV (between power terminals) for 100 to 120 VAC, 200 to 240 VAC, 100 to 125 VDC; 1 kV for 24 VAC/DC, 48 VDC 4.5 kV (between current-carrying terminal and exposed non-current-carrying metal parts) for 100 to 120 VAC, 200 to 240 VAC, 100 to 125 VDC; 1.5 kV for 24 VAC/DC, 48 VDC
Noise immunity	±1.5 kV (between power terminals) and ±600 V (between input terminals), square-wave noise by noise simulator (pulse width: 100 ns/1 μs, 1-ns rise); ±1 kV (between power terminals) for 48 VDC
Static immunity	Malfunction: 8 kV, Destruction: 15 kV
Vibration resistance	Destruction: 10 to 55 Hz with 0.75-mm single amplitude for 2 hrs each in three directions Malfunction: 10 to 55 Hz with 0.5-mm single amplitude for 10 min each in three directions
Shock resistance	Destruction: 980 m/s ² three times each in six directions Malfunction: 98 m/s ² three times each in six directions
Ambient temperature	Operating: -10°C to 55°C (with no icing), Storage: -25°C to 65°C (with no icing)
Ambient humidity	Operating: 35% to 85%
Life expectancy	Mechanical: 10 million operations min. (under no load at 1,200 operations/h) Electrical: 100,000 operations min. (5 A at 250 VAC, resistive load at 1,200 operations/h) (See note)
EMC	(EMI) Emission Enclosure: EN61812-1 Emission AC Mains: EN55011 Group 1 class A (EMS) Immunity ESD: IEC61000-4-2: 6 kV contact discharge (level 3) 8 kV air discharge (level 3) Immunity RF-interference from AM Radio Waves: IEC61000-4-3: 10 V/m (80 MHz to 1 GHz) (level 3) Immunity RF-interference from Pulse-modulated Radio Waves: IEC61000-4-3: 10 V/m (900±5 MHz) (level 3) Immunity Conducted Disturbance: IEC61000-4-6: 10 V (0.15 to 80 MHz) (level 3) Immunity Burst: IEC61000-4-4: 2 kV power-line (level 3) 2 kV I/O signal-line (level 4) Immunity Surge: IEC61000-4-5: 1 kV line to line (level 3) 2 kV line to ground (level 3)
Case color	Light Gray (Munsell 5Y7/1)
Degree of protection	IP40 (panel surface)
Weight	Approx. 120 g

Note: Refer to the *Life-test Curve*.

Life-test Curve

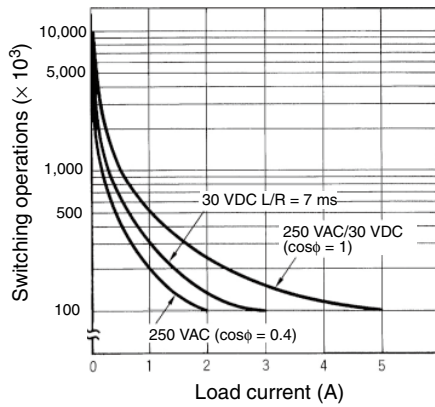

Reference: A maximum current of 0.15 A can be switched at 125 VDC ($\cos\phi = 1$) and a maximum current of 0.1 A can be switched if L/R is 7 ms. In both cases, a life of 100,000 operations can be expected. The minimum applicable load is 10 mA at 5 VDC for H3CR-H8L/-HRL and 100 mA at 5 VDC for H3CR-H8RL (failure level: P).

Connections

Block Diagrams

Without Reset Input (H3CR-H8L)

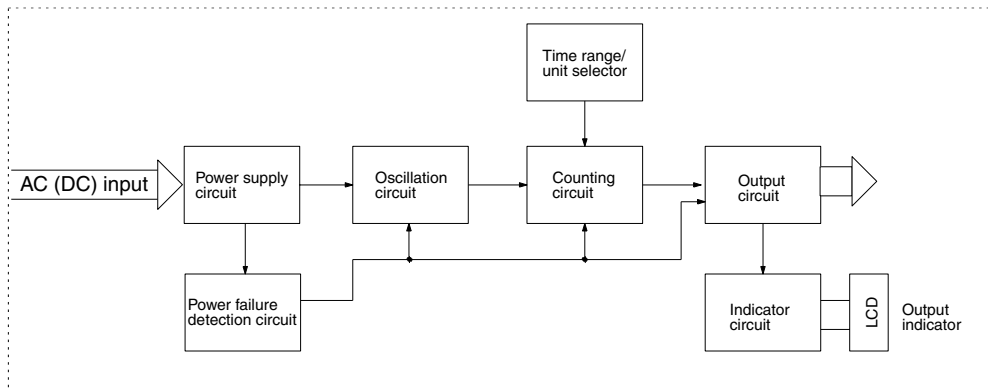

With Reset Input (H3CR-H8RL/-HRL)

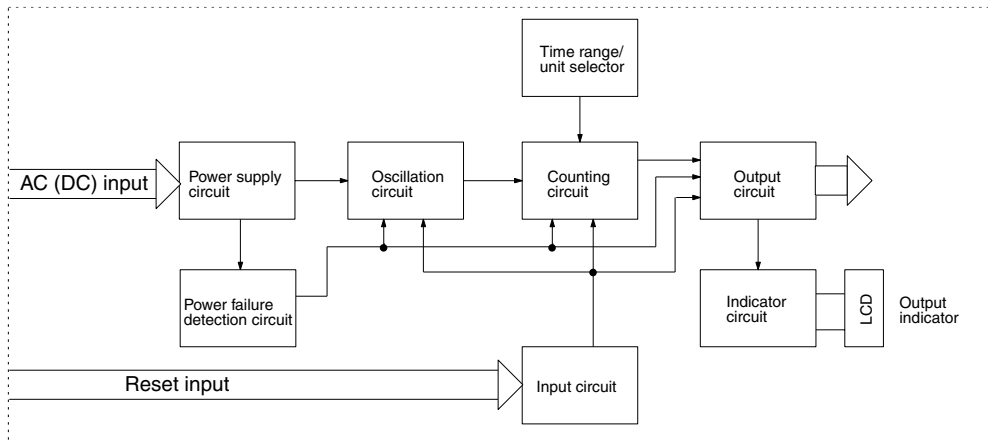

I/O Functions

Inputs	Reset	Turns off the control output and resets the elapsed time.
Outputs	Control output	Operates instantaneously when the power is turned on and time-limit resets when the set time is up after the power is turned off.

Terminal Arrangement

Note: DC models, including 24 VAC/DC models, have polarity.

8-pin Models

Without Reset Input (H3CR-H8L)

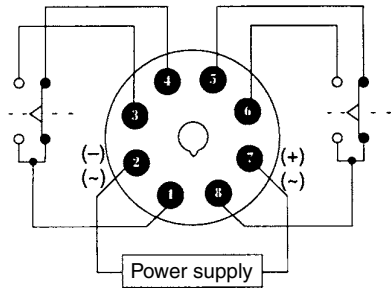

With Reset Input (H3CR-H8RL)

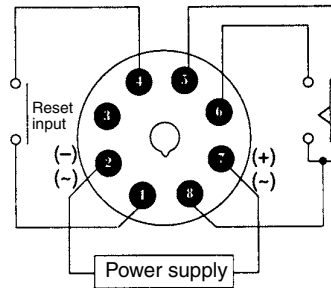

Note: Leave terminal 3 open. Do not use them as relay terminals.

11-pin Model

With Reset Input (H3CR-HRL)

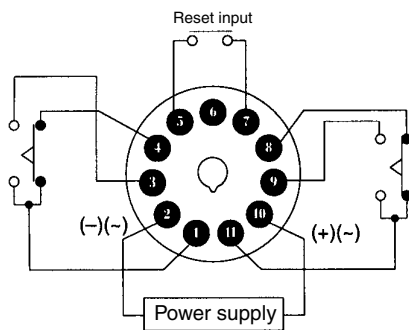

Note: Leave terminal 6 open. Do not use them as relay terminals.

Operation

■ Timing Chart

t: Set time

Rt: Minimum power ON time (S-series: 0.1 s min.; M-series: 2 s min.)

If the power ON time is less than this value, the Timer may not operate (i.e., output may not turn ON).

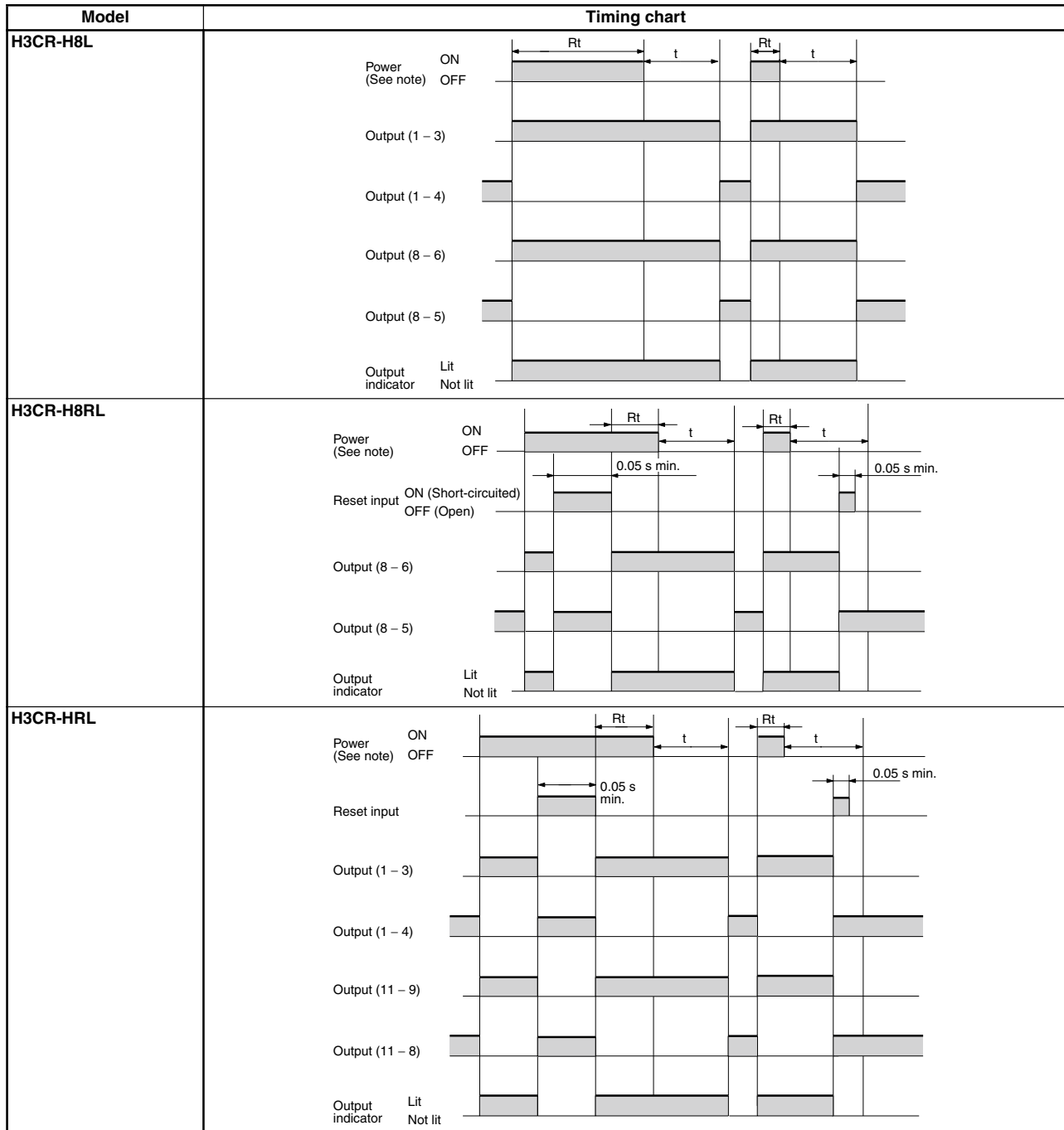

Note: If the power is turned ON until the set time is up, the timer will be retriggered.

Nomenclature

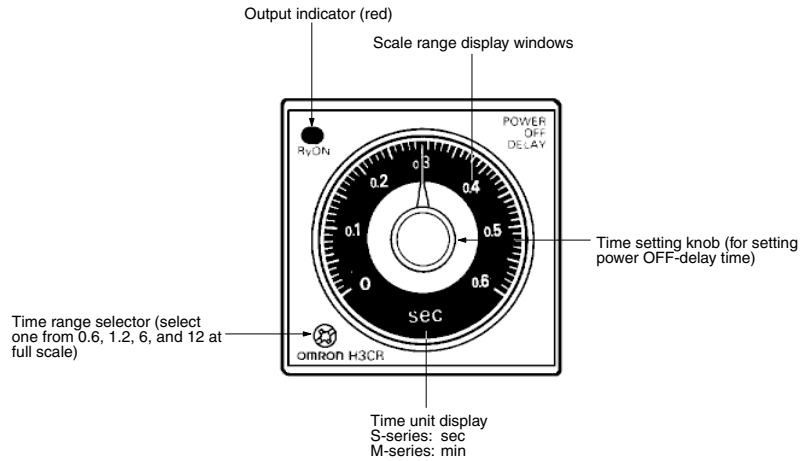

Dimensions

Note: All units are in millimeters unless otherwise indicated.

H3CR-H8L H3CR-H8RL

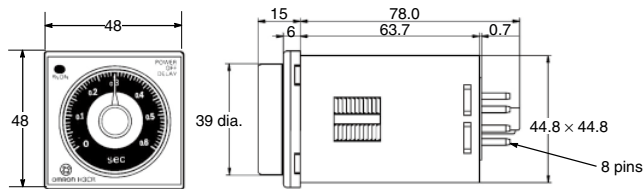
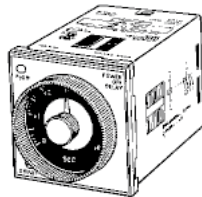

H3CR-HRL

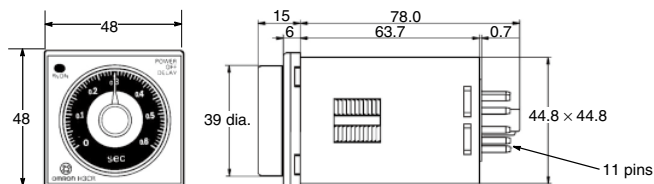
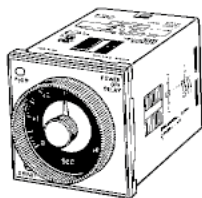

Dimensions with Front Connecting Socket P2CF-08-□/ P2CF-11-□

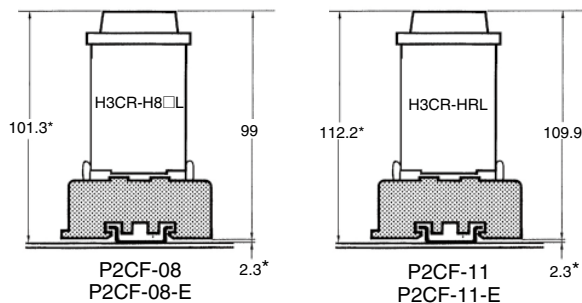

Dimensions with Back Connecting Socket P3G-08/P3GA-11

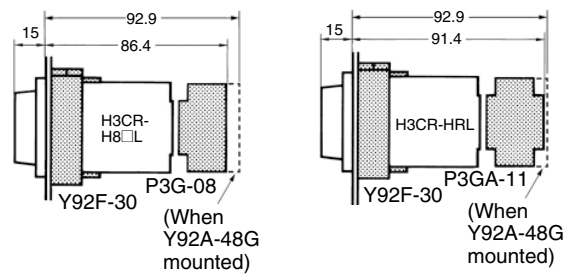

*These dimensions vary with the kind of DIN track (reference value).

Safety Precautions (H3CR-H)

Note: The undermentioned is common for all H3CR-H models.

Power Supplies

The H3CR-H has a large inrush current; provide sufficient power supply capacity. If the power supply capacity is too small, there may be delays in turning ON the output.

With the H3CR-H□RL, for the power supply of an input device, use an isolating transformer, of which the primary and secondary windings are mutually isolated and the secondary winding is not grounded.

Correct

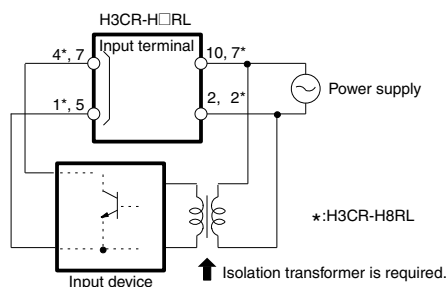

Incorrect

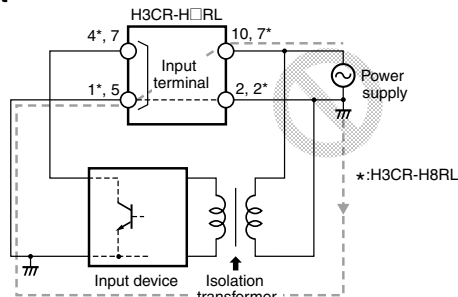

Input/Output (H3CR-H□RL)

An appropriate input is applied to the input signal terminal of the Timer when the input terminal for the input signal is short-circuited. Do not attempt to connect any input terminal to any terminal other than the input terminal or to apply voltage across other than the specified input terminals or the internal circuits of the Timer may be damaged.

The H3CR-H□RL uses transformerless power supply. When connecting a relay or transistor as an external signal input device, pay attention to the following points to prevent short-circuiting due to a sneak current to the transformerless power supply.

If input is made simultaneously from one input contact or a transistor to the H3CR-H and a Timer whose common input terminals are used as power terminals, such as the H3CR-A, a short-circuit current will be generated. Either input through isolated contacts, or isolate the power supply for one of the Timers.

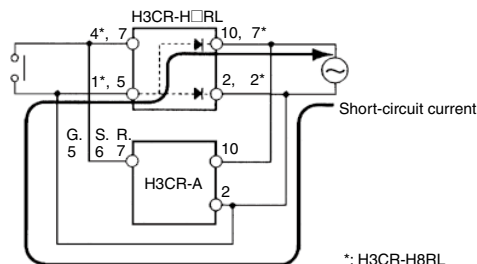

ALL DIMENSIONS SHOWN ARE IN MILLIMETERS.

To convert millimeters into inches, multiply by 0.03937. To convert grams into ounces, multiply by 0.03527.

In the interest of product improvement, specifications are subject to change without notice.

Wiring

The H3CR-H has a high impedance circuit. Therefore, the H3CR-H may not be reset if the H3CR-H is influenced by inductive voltage. In order to eliminate any influence of inductive voltage, the wires connected to the H3CR-H must be as short as possible and should not be installed alongside power lines. If the H3CR-H is influenced by inductive voltage that is 30% or more of the rated voltage, connect a CR filter with a capacitance of approximately 0.1 μF and a resistance of approximately 120 Ω or a bleeder resistor between the power supply terminals. If there is any residual voltage due to current leakage, connect a bleeder resistor between the power supply terminals.

Operation

An interval of 3 s minimum is required to turn on the H3CR-H after the H3CR-H is turned off. If the H3CR-H is turned on and off repeatedly with an interval of shorter than 3 s, abnormal heating or burning may occur in internal elements.

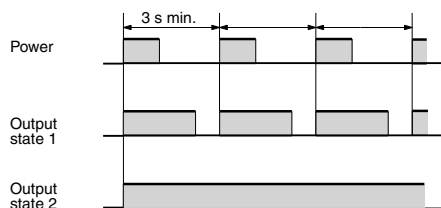

After the forced reset function of the H3CR-H is activated, an interval of 3 s minimum is required to activate the forced reset function again. If the forced reset function is activated repeatedly with an interval of shorter than 3 s, the internal parts of the H3CR-H may deteriorate and the H3CR-H may malfunction.

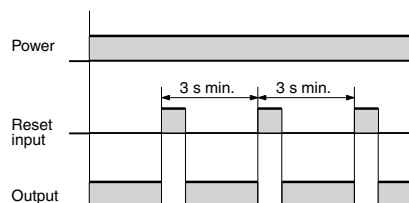

If it is required that the output be turned on repeatedly with an interval of shorter than 3 s, consider use of the H3CR-A in mode D (signal OFF-delay).

Others

If the H3CR-H is dropped or experiences some other kind of shock, because a latching relay is used for output, contacts may be reversed or go into a neutral state. If the H3CR-H is dropped, reconfirm correct operation.

Safety Precautions for All Timers

Refer to the *Safety Precautions* for individual Timers for precautions specific to each Timer.

WARNING

The following Timers contain lithium batteries that are not explosion proof.



1. Timers with Built-in Batteries: H5L
The Timer contains a lithium battery, which may occasionally ignite or rupture. Do not disassemble, deform under pressure, heat to 100°C or higher, or incinerate the Timer.
2. Timers with Replaceable Batteries: Y92S-20 (for H5CN-M)
The battery may occasionally rupture, ignite, or leak fluid. Do not short the positive and negative terminals. Do not charge, disassemble, deform under pressure, or throw the battery into a fire. If a non-specified battery is used, the battery may leak fluid or rupture, occasionally resulting in equipment failure or minor injury. Use only the specified battery.

CAUTION

The following Timers contain lithium batteries that are explosion proof.



Timers with Built-in Batteries: H5BR, H5AN-4DM, H5S, H5F, and H4KV

The Timer contains a lithium battery, which may occasionally ignite or rupture. Do not disassemble, deform under pressure, heat to 100°C or higher, or incinerate the Timer.

Precautions for Safe Use

Operating Environment

- Use the Timer within the ratings specified for ambient operating temperature and ambient operating humidity for each model.
- Store the Timer with the specified temperature range for each model. If the Timer has been stored at a temperature of less than -10°C, allow the Timer to stand at room temperature for at least 3 hours before using it.
- Use the Timer within the performance specified for water and oil exposure for each model.
- Do not use the Timer in locations subject to shock and vibration. Long-term usage in such locations may damage the Timer due to stress.
Magnetic contactors generate a shock of 1,000 to 2,000 m/s² when switching a load. When mounting to DIN Track, separate magnetic contactors from the Timer so that the Timer is not subjected to vibration and shock. Use anti-vibration rubber.
- Do not use the Timer in locations subject to excessive dust, corrosive gases, or direct sunlight.
- Do not use organic solvents (such as paint thinner or benzene), strong alkalis, or strong acids because they will damage the external finish of the Timer.
- Separate the input devices, input wiring, and Timer as far as possible from sources of noise and power lines carrying noise.
- When using the Timer in environments subject to large amounts of static electricity (e.g., pipes carrying molding materials, powders, or fluid materials), separate the Timer as far as possible from the sources of static electricity.
- Do not remove the external case from the Timer.
- Do not use the Timer in locations where condensation may occur due to high humidity or sudden temperature changes.
Condensation inside the Timer may result in malfunction or damage to Timer elements.
- The life of internal parts may be reduced if Timers are mounted in close proximity to each other.
- Resin and rubber parts (e.g., rubber packing) may deteriorate, shrink, or harden depending on the operating environment (e.g., subjected to corrosive gases, ultraviolet light, or high temperatures). We recommend periodic inspection and replacement.

- Normal operation may not be possible in locations subject to sulfidizing gas, such as in sewer systems or waste incinerators. OMRON does not market any Timers or other control devices for operation in atmospheres containing sulfidizing gas. Seal the Timer so that sulfidizing gas will not enter it. If sealing is not possible, OMRON does provide special Timers with improved resistance to sulfidizing gas. Ask your OMRON representative for details.

Power Supply

- Be sure that the voltage applied is within the specified range, otherwise the internal elements of the Timer may be damaged.
- Install a switch or circuit breaker that allows the operator to immediately turn OFF the power, and label it to clearly indicate its function.
- Maintain voltage fluctuations in the power supply within the specified range.

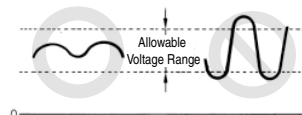

- Use a commercial power supply for the power supply voltage input to models with AC inputs. Inverters with an output frequency of 50/60 Hz are available, but the rise in the internal temperature of the Timer may result in ignition or burning. Do not use an inverter output for the power supply of the Timer.
- The Timers listed below cannot be directly turned ON and OFF by using an AC 2-wire proximity sensor to turn the Timer's power supply ON and OFF. Use the following countermeasure when using an AC 2-wire proximity sensor with the Timer. (The power supply circuit in the Timer uses half-wave rectification. Only a half AC wave is supplied to the proximity sensor, which may cause operation to be unstable.)

Applicable Models

H3Y, H3YN, H3RN, H3CA-8, RD2P, and H3CR(-A, -A8, -AP, -F, and -G)

Countermeasure

- Wire through a relay and use the relay contacts to turn the power supply ON and OFF.
Confirm the stability of operation after making the connections.
- Install protective measures (such as earth leakage breakers, wiring breakers, or fuses) on the power supply side according to any applicable laws or regulations.

Correctly Handling Input Signals

Malfunction due to noise may occur if input wiring is placed in the same duct or conduit as power lines or high-voltage lines. Separate input wiring from power lines and wire them in a separate system. Also, use shielded cables, use metal conduits, and keep wiring distances as short as possible.

Timers with Relays

- Do not connect a load that exceeds contact ratings, such as the switching capacity (contact voltage or contact current). Insulation faults, contact welding, contact faults, and other failures to achieve specified performance may occur and the relay may be damaged or may burn.
- Continued use with deteriorated performance may ultimately result in insulation breakdown between circuits or relay burning. The life of the built-in relay is greatly affected by switching conditions. Before using the Timer, test operation under actual application conditions and confirm that the switching frequency presents no problems in performance.
- Electrical life depends on the type of load, switching frequency, and ambient environment. Observe the following precautions when using the Timer. When switching a DC load, contact transfer may cause the contacts to stick or may cause contact failure. Confirm applicability and consider using a surge absorbing element. When switching at high frequencies, heat generated by arcing may cause contacts to melt or may cause metal corrosion. Consider connecting an arc absorbing element, reducing the switching frequency, or lowering the humidity.
- The surge current depends on the type of load, which also affects contact switching frequency and the number of operations. Check the rated current and the surge current, and design the circuits with sufficient margin.

Resistive load	Solenoid load	Motor load	Incandescent lamp load
Rated current	10 to 20 times the rated current	5 to 10 times the rated current	10 to 20 times the rated current

Sodium light loads	Capacitor loads	Transformer loads	Mercury light loads
1 to 3 times the rated load	20 to 40 times the rated load	5 to 15 times the rated load	1 to 3 times the rated load

- Arcing when switching and relay heating may result in ignition or explosion. Do not use the Timer in atmospheres subject to inflammable or explosive gases.
- Contact faults may occur. Do not use the Timer in atmospheres subject to sulfidizing gas, chloride gas, or silicon gas.
- The switching capacity for DC voltage loads is lower than that for AC voltage loads.

Timers with Non-contact Outputs

- Short faults or open faults may occur due to destruction of the output element. Do not use the Timer for a load that exceeds the rated output current.
- Short faults or open faults may occur due to destruction of the output element from reverse electromotive force. When using the Timer for a DC inductive load, always connect a diode as a countermeasure against reverse electromotive force.

Other Precautions

- Confirm that you have the correct model before using it.
- Be sure that all terminals are wired correctly.
- Always test the output status with a tester before using a Timer with a built-in keep relay (e.g., the H3CR-H and H3DE-H). Shock resulting from dropping the Timer during transport or handling may cause the output contacts to reverse or to be in a neutral status.
- Leaving the Timer with outputs ON at a high temperature for a long time may hasten the degradation of internal parts (such as electrolytic capacitors). Use the Timer in combination with relays and avoid leaving the Timer with the output turned ON for an extended period of time (e.g., for more than a month). Reference Example (Use the Timer as shown below.)

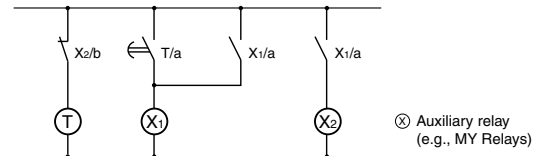

- Be sure that only a qualified worker (e.g., an electrical engineer) performs electrical work for the Timer.

ALL DIMENSIONS SHOWN ARE IN MILLIMETERS.

To convert millimeters into inches, multiply by 0.03937. To convert grams into ounces, multiply by 0.03527.

In the interest of product improvement, specifications are subject to change without notice.

Read and Understand This Catalog

Please read and understand this catalog before purchasing the products. Please consult your OMRON representative if you have any questions or comments.

Warranty and Limitations of Liability

WARRANTY

OMRON's exclusive warranty is that the products are free from defects in materials and workmanship for a period of one year (or other period if specified) from date of sale by OMRON.

OMRON MAKES NO WARRANTY OR REPRESENTATION, EXPRESS OR IMPLIED, REGARDING NON-INFRINGEMENT, MERCHANTABILITY, OR FITNESS FOR PARTICULAR PURPOSE OF THE PRODUCTS. ANY BUYER OR USER ACKNOWLEDGES THAT THE BUYER OR USER ALONE HAS DETERMINED THAT THE PRODUCTS WILL SUITABLY MEET THE REQUIREMENTS OF THEIR INTENDED USE. OMRON DISCLAIMS ALL OTHER WARRANTIES, EXPRESS OR IMPLIED.

LIMITATIONS OF LIABILITY

OMRON SHALL NOT BE RESPONSIBLE FOR SPECIAL, INDIRECT, OR CONSEQUENTIAL DAMAGES, LOSS OF PROFITS, OR COMMERCIAL LOSS IN ANY WAY CONNECTED WITH THE PRODUCTS, WHETHER SUCH CLAIM IS BASED ON CONTRACT, WARRANTY, NEGLIGENCE, OR STRICT LIABILITY.

In no event shall responsibility of OMRON for any act exceed the individual price of the product on which liability is asserted.

IN NO EVENT SHALL OMRON BE RESPONSIBLE FOR WARRANTY, REPAIR, OR OTHER CLAIMS REGARDING THE PRODUCTS UNLESS OMRON'S ANALYSIS CONFIRMS THAT THE PRODUCTS WERE PROPERLY HANDLED, STORED, INSTALLED, AND MAINTAINED AND NOT SUBJECT TO CONTAMINATION, ABUSE, MISUSE, OR INAPPROPRIATE MODIFICATION OR REPAIR.

Application Considerations

SUITABILITY FOR USE

OMRON shall not be responsible for conformity with any standards, codes, or regulations that apply to the combination of products in the customer's application or use of the product.

At the customer's request, OMRON will provide applicable third party certification documents identifying ratings and limitations of use that apply to the products. This information by itself is not sufficient for a complete determination of the suitability of the products in combination with the end product, machine, system, or other application or use.

The following are some examples of applications for which particular attention must be given. This is not intended to be an exhaustive list of all possible uses of the products, nor is it intended to imply that the uses listed may be suitable for the products:

- Outdoor use, uses involving potential chemical contamination or electrical interference, or conditions or uses not described in this catalog.
- Nuclear energy control systems, combustion systems, railroad systems, aviation systems, medical equipment, amusement machines, vehicles, safety equipment, and installations subject to separate industry or government regulations.
- Systems, machines, and equipment that could present a risk to life or property.

Please know and observe all prohibitions of use applicable to the products.

NEVER USE THE PRODUCTS FOR AN APPLICATION INVOLVING SERIOUS RISK TO LIFE OR PROPERTY WITHOUT ENSURING THAT THE SYSTEM AS A WHOLE HAS BEEN DESIGNED TO ADDRESS THE RISKS, AND THAT THE OMRON PRODUCT IS PROPERLY RATED AND INSTALLED FOR THE INTENDED USE WITHIN THE OVERALL EQUIPMENT OR SYSTEM.

Disclaimers

CHANGE IN SPECIFICATIONS

Product specifications and accessories may be changed at any time based on improvements and other reasons.

It is our practice to change model numbers when published ratings or features are changed, or when significant construction changes are made. However, some specifications of the product may be changed without any notice. When in doubt, special model numbers may be assigned to fix or establish key specifications for your application on your request. Please consult with your OMRON representative at any time to confirm actual specifications of purchased product.

DIMENSIONS AND WEIGHTS

Dimensions and weights are nominal and are not to be used for manufacturing purposes, even when tolerances are shown.

ERRORS AND OMISSIONS

The information in this catalog has been carefully checked and is believed to be accurate; however, no responsibility is assumed for clerical, typographical, or proofreading errors, or omissions.

PERFORMANCE DATA

Performance data given in this catalog is provided as a guide for the user in determining suitability and does not constitute a warranty. It may represent the result of OMRON's test conditions, and the users must correlate it to actual application requirements. Actual performance is subject to the OMRON Warranty and Limitations of Liability.

PROGRAMMABLE PRODUCTS

OMRON shall not be responsible for the user's programming of a programmable product, or any consequence thereof.

COPYRIGHT AND COPY PERMISSION

This catalog shall not be copied for sales or promotions without permission.

This catalog is protected by copyright and is intended solely for use in conjunction with the product. Please notify us before copying or reproducing this catalog in any manner, for any other purpose. If copying or transmitting this catalog to another, please copy or transmit it in its entirety.