

HA17558 Series

Dual Operational Amplifier

REJ03D0682-0100
(Previous: ADE-204-042)
Rev.1.00
Jun 15, 2005

Description

HA17558 is dual operational amplifiers which provides internal frequency compensation and high performance. It can be applied widely to measuring control equipment and to general Use. The two amplifiers share a common bias network and power supply leads.

Features

- High voltage Gain: 104dB (Typ)
- High speed: 1V/ μ s
- Continuous short-circuit protection
- Low-noise operational amplifiers
- Internal frequency compensation

Ordering Information

Type No.	Application	Package Code (Previous Code)
HA17558FP	Industrial use	PRSP0008DE-B (FP-8DGV)
HA17558F	Commercial use	PRSP0008DE-B (FP-8DGV)
HA17558	Commercial use	PRDP0008AF-A (DP-8B)
HA17558PS	Industrial use	PRDP0008AF-A (DP-8B)

Pin Arrangement

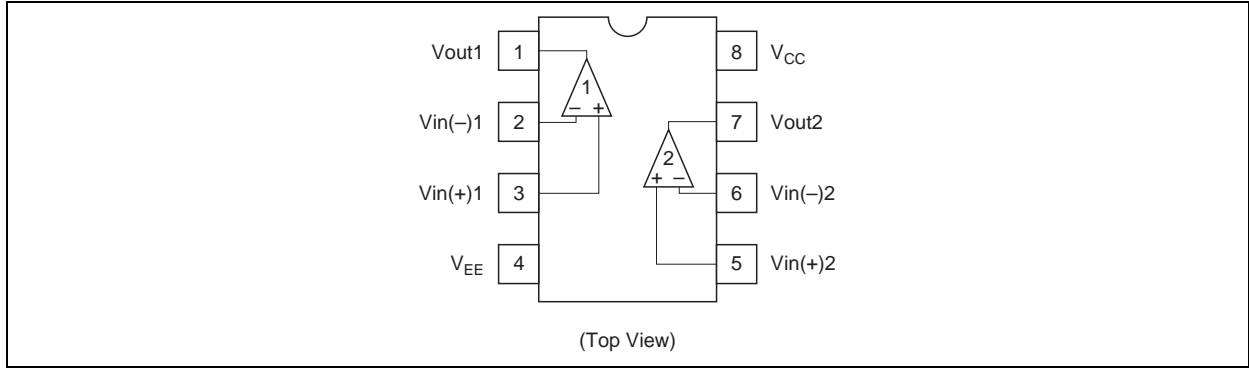

Circuit Schematic (1/2)

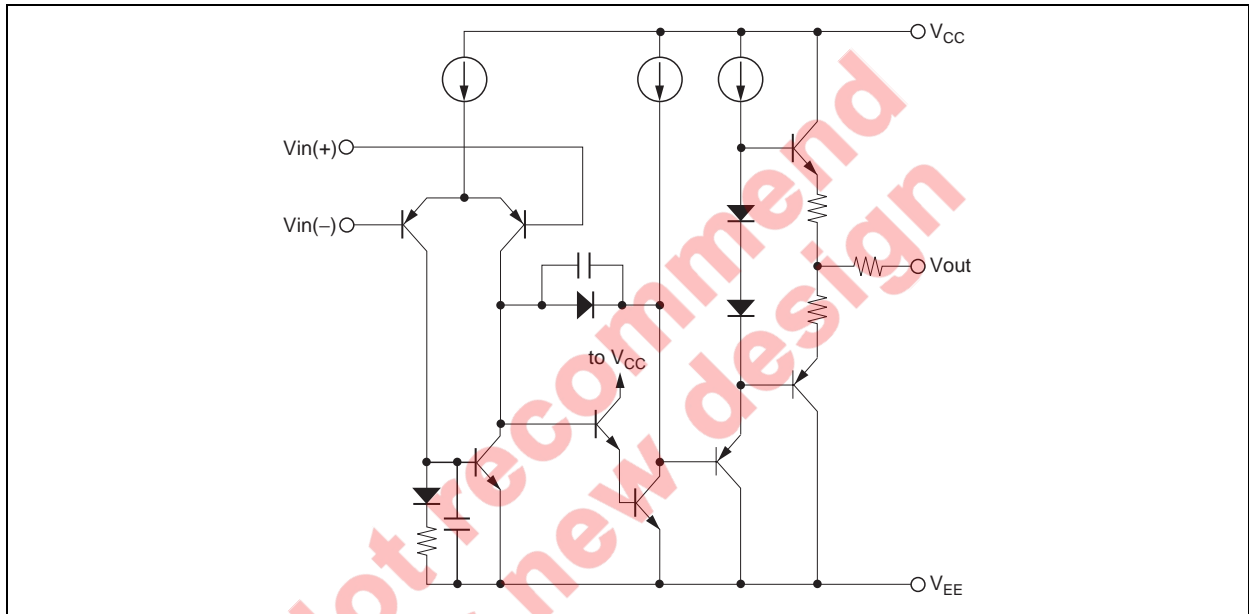

Absolute Maximum Ratings

(Ta = 25°C)

Item	Symbol	Ratings				Unit
		HA17558	HA17558PS	HA17558F	HA17558FP	
Supply voltage	V _{CC}	+18	+18	+18	+18	V
	V _{EE}	-18	-18	-18	-18	V
Differential input voltage	V _{IN (diff)}	±30	±30	±30	±30	V
Common-mode input voltage	V _{CM} * ³	±15	±15	±15	±15	V
Power dissipation	P _T	670* ¹	670* ¹	385* ²	385* ²	mW
Operating temperature	Topr	-20 to +75	-20 to +75	-20 to +75	-20 to +75	-20 to +75
Storage temperature	Tstg	-55 to +125	-55 to +125	-55 to +125	-55 to +125	°C

- Notes: 1. These are the allowable values up to Ta = 45 °C. Derate by 8.3mW/°C above that temperature.
 2. These are the allowable values up to Ta = 31 °C mounting on 30% wiring density glass epoxy board. Derate by 7.14mW/°C above that temperature.
 3. If the supply voltage is less than ±15V, input voltage should be less than supply voltage.

Electrical Characteristics

(Ta = 25°C, V_{CC} = +15V, V_{EE} = -15V)

Item	Symbol	Min	Typ	Max	Unit	Test conditions
Input offset voltage	V _{IO}	—	0.5	6	mV	R _S ≤ 10kΩ
Input offset current	I _{IO}	—	5	200	nA	
Input bias current	I _{IB}	—	50	500	nA	
Voltage gain	A _{VD}	86	104	—	dB	R _L ≥ 2kΩ, V _O = ±10V
Maximum output voltage	V _{op-p}	±12	±14	—	V	R _L ≥ 10kΩ
Maximum output voltage	V _{op-p}	±10	±12.4	—	V	R _L ≥ 2kΩ
Common mode input voltage range	V _{CM}	±12	±14	—	V	
Common mode rejection ratio	CMR	70	100	—	dB	R _S ≤ 10kΩ
Supply voltage rejection ratio	PSRR	—	10	150	μV/V	R _S ≤ 10kΩ
Power dissipation	P _d	—	90	170	mW	2-channel, No load
Slew rate	SR	—	1.0	—	V/μs	A _{VD} = 1
Equivalent input noise voltage	V _{NI}	—	6	—	μVp-p	R _S = 1kΩ, f = 1Hz to 1kHz
Channel separation	CS	—	105	—	dB	f = 1kHz

Characteristic Curves

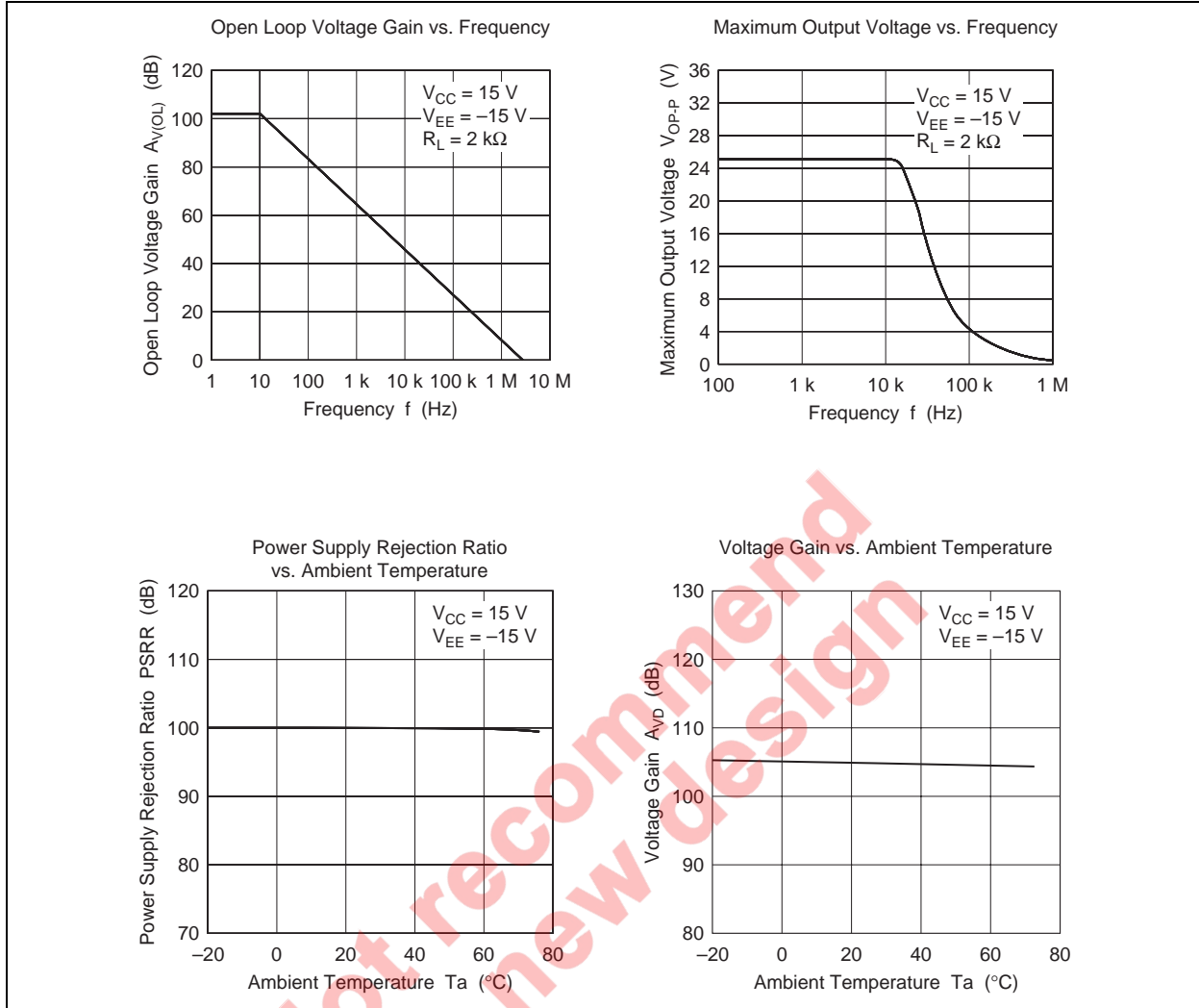

Power Supply Rejection Ratio vs. Frequency

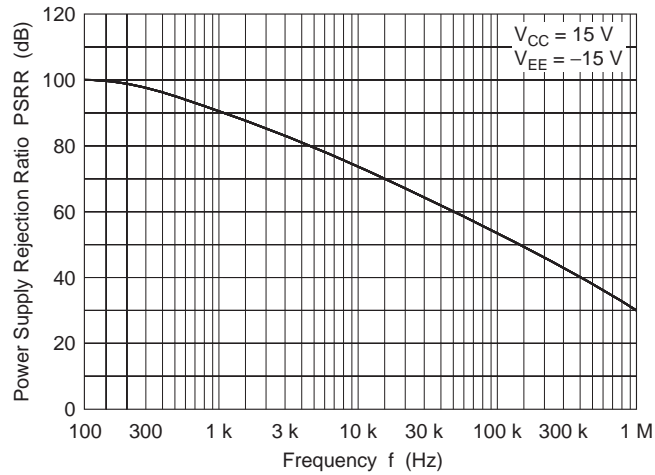

Common-mode Rejection Ratio vs. Frequency

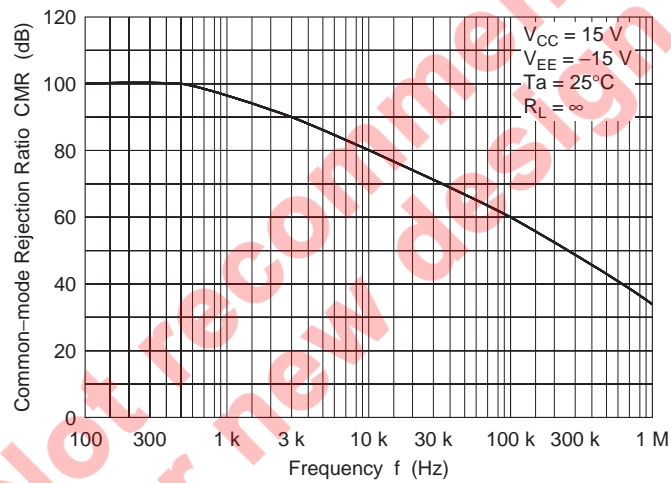

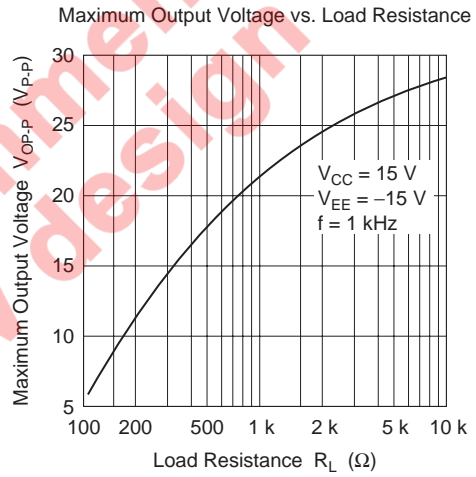
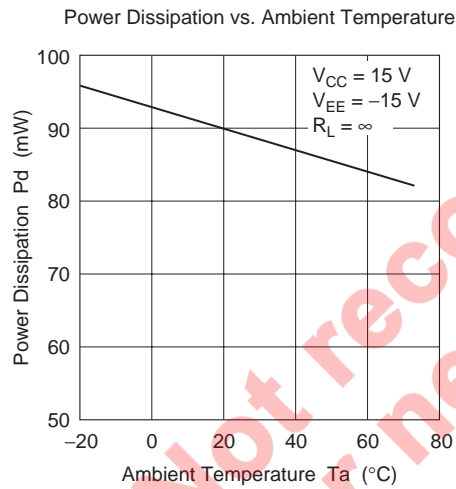
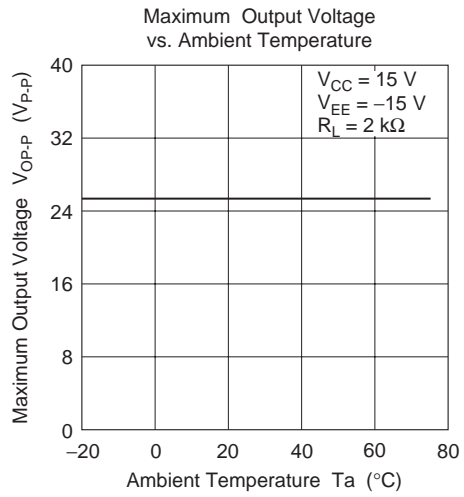
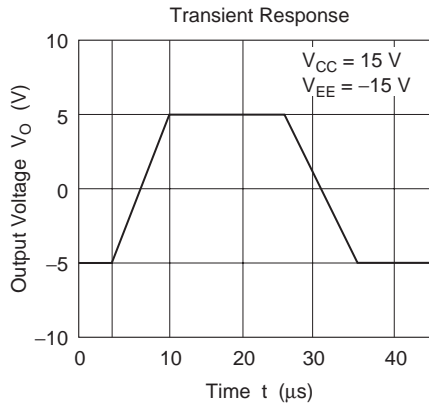

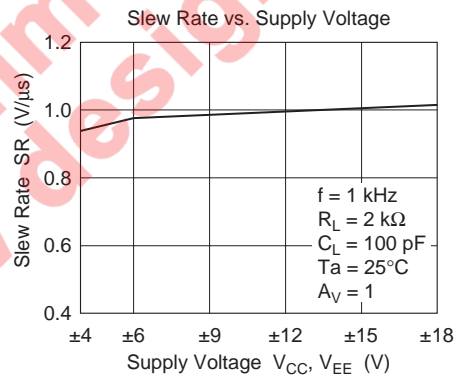
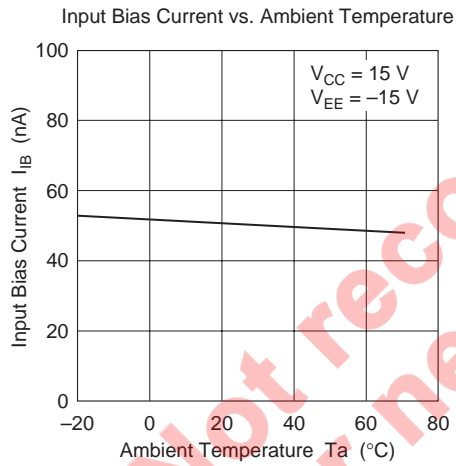
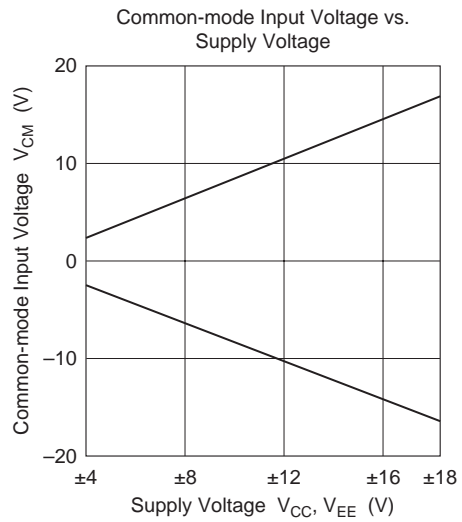
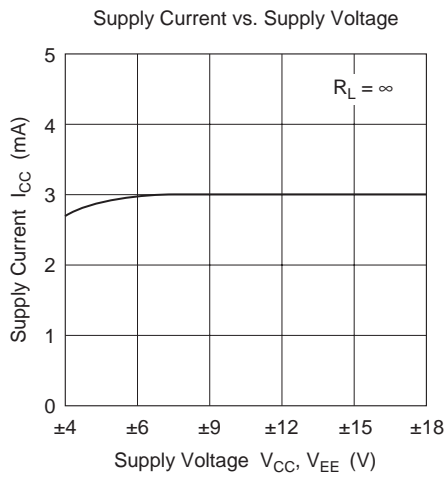

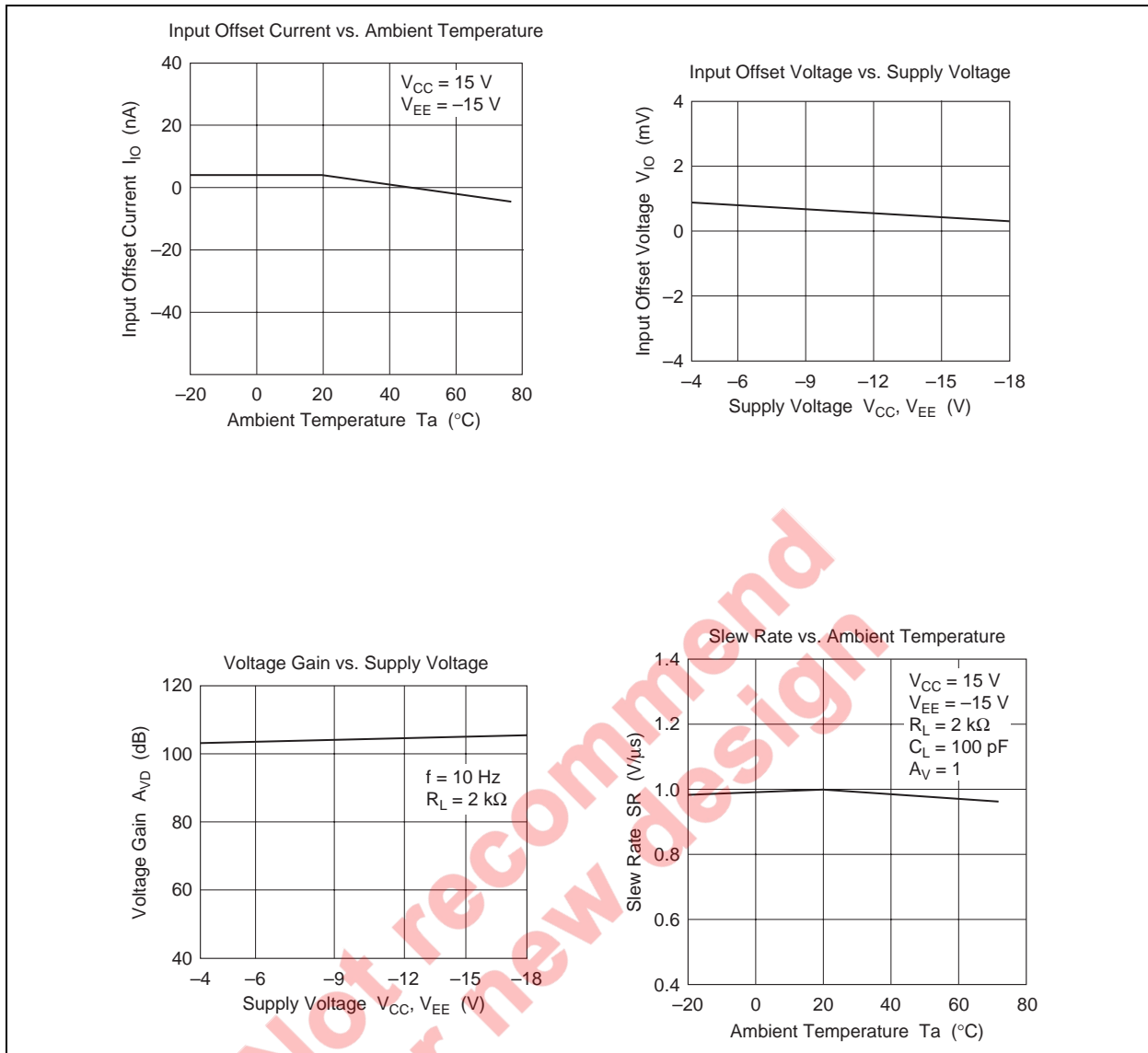

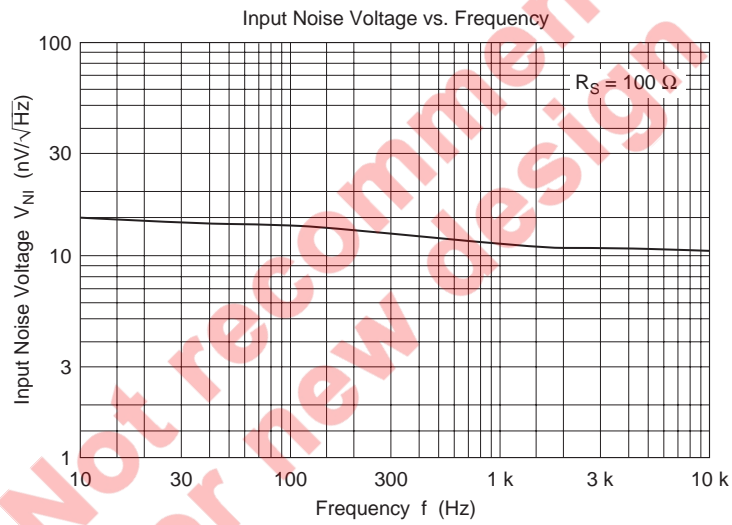
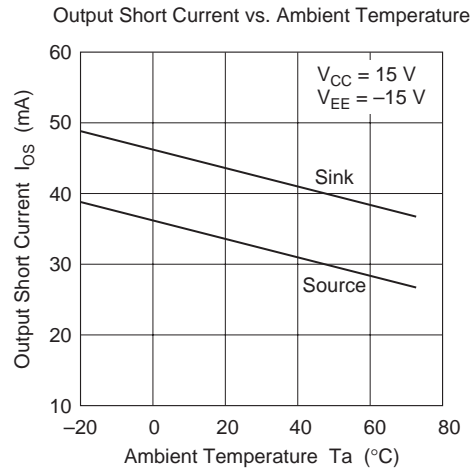

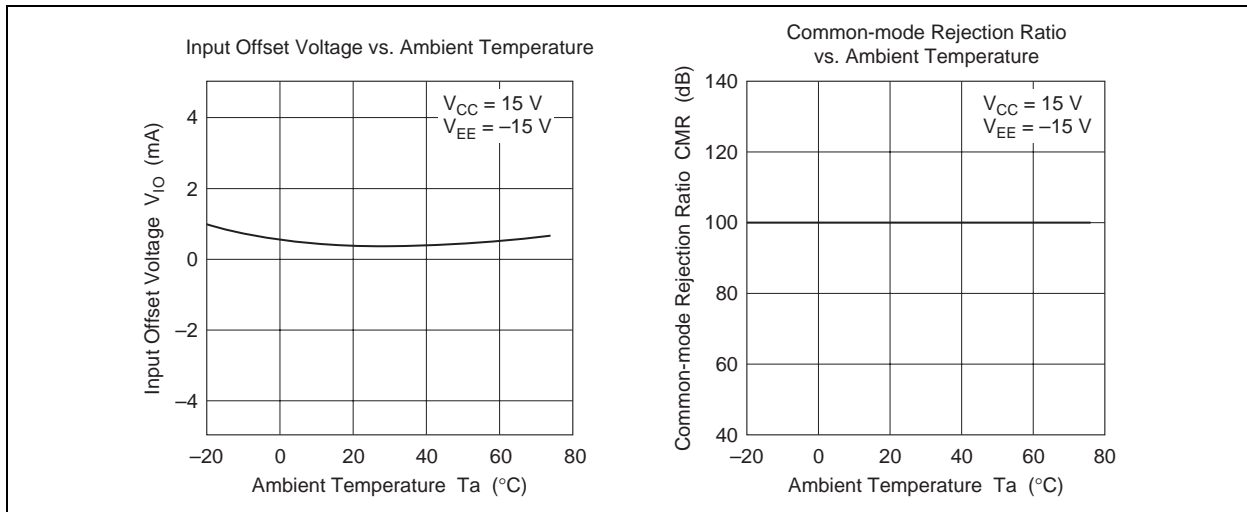

Not recommend
for new design

Circuit Example

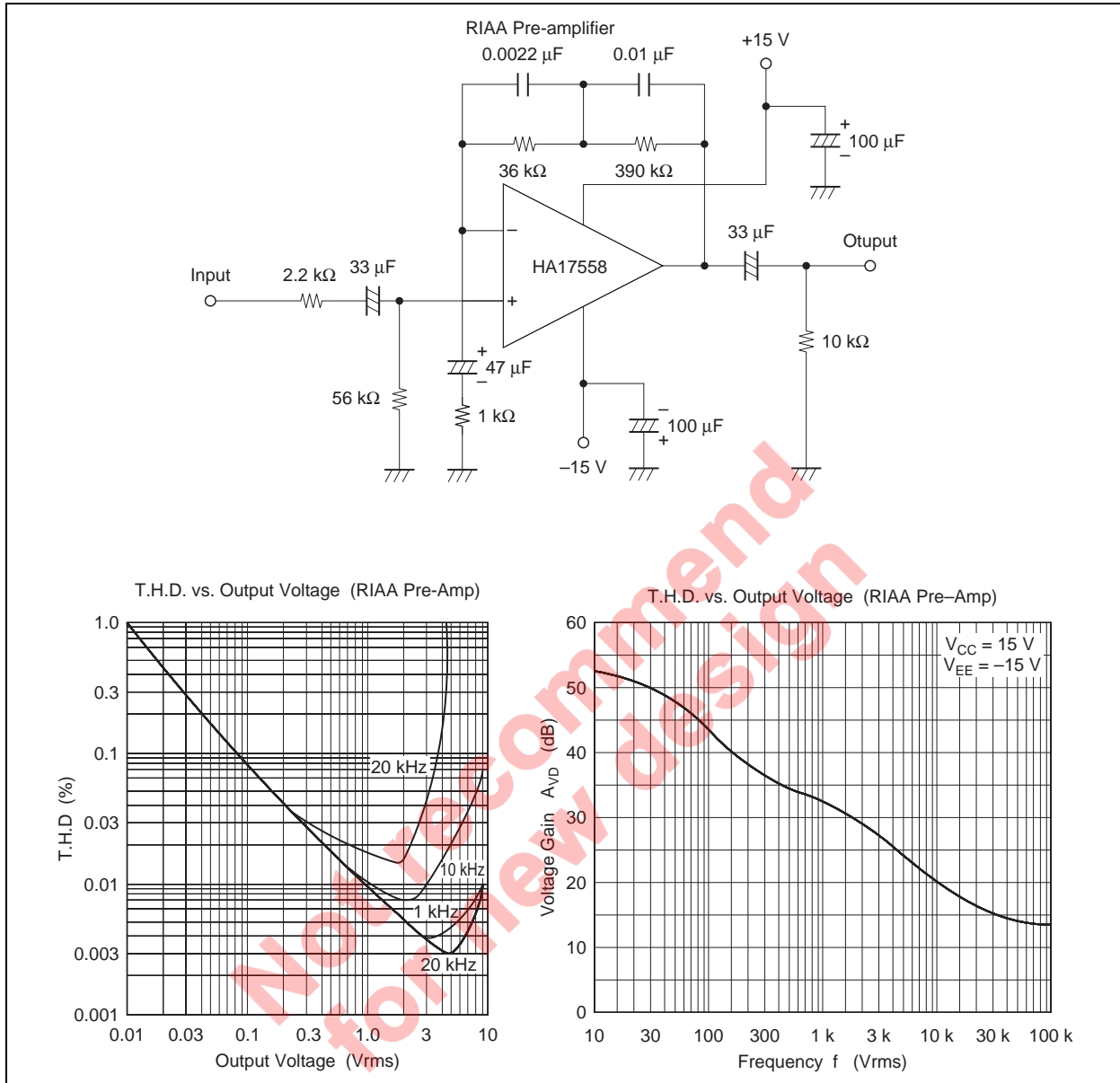

Package Dimensions

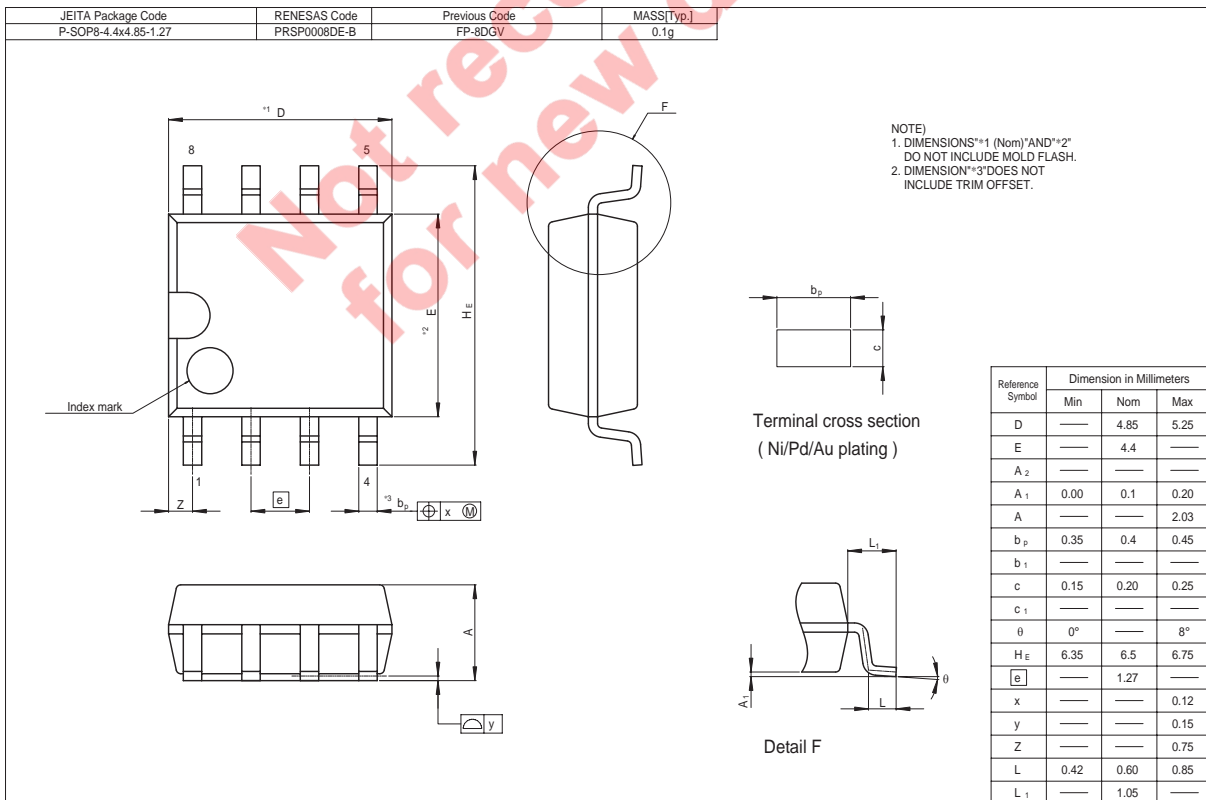
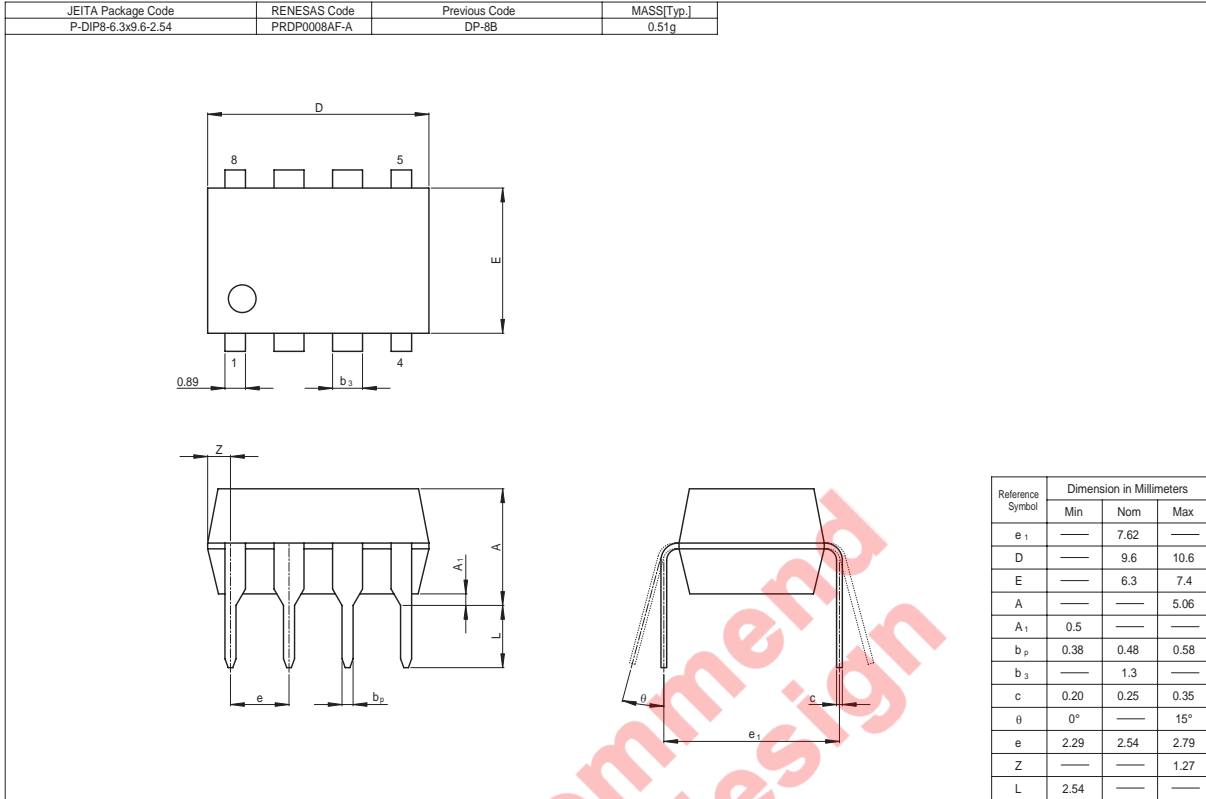

Renesas Technology Corp. Sales Strategic Planning Div. Nippon Bldg., 2-6-2, Ohte-machi, Chiyoda-ku, Tokyo 100-0004, Japan

Keep safety first in your circuit designs!

1. Renesas Technology Corp. puts the maximum effort into making semiconductor products better and more reliable, but there is always the possibility that trouble may occur with them. Trouble with semiconductors may lead to personal injury, fire or property damage. Remember to give due consideration to safety when making your circuit designs, with appropriate measures such as (i) placement of substitutive, auxiliary circuits, (ii) use of nonflammable material or (iii) prevention against any malfunction or mishap.

Notes regarding these materials

1. These materials are intended as a reference to assist our customers in the selection of the Renesas Technology Corp. product best suited to the customer's application; they do not convey any license under any intellectual property rights, or any other rights, belonging to Renesas Technology Corp. or a third party.
2. Renesas Technology Corp. assumes no responsibility for any damage, or infringement of any third-party's rights, originating in the use of any product data, diagrams, charts, programs, algorithms, or circuit application examples contained in these materials.
3. All information contained in these materials, including product data, diagrams, charts, programs and algorithms represents information on products at the time of publication of these materials, and are subject to change by Renesas Technology Corp. without notice due to product improvements or other reasons. It is therefore recommended that customers contact Renesas Technology Corp. or an authorized Renesas Technology Corp. product distributor for the latest product information before purchasing a product listed herein. The information described here may contain technical inaccuracies or typographical errors. Renesas Technology Corp. assumes no responsibility for any damage, liability, or other loss rising from these inaccuracies or errors. Please also pay attention to information published by Renesas Technology Corp. by various means, including the Renesas Technology Corp. Semiconductor home page (<http://www.renesas.com>).
4. When using any or all of the information contained in these materials, including product data, diagrams, charts, programs, and algorithms, please be sure to evaluate all information as a total system before making a final decision on the applicability of the information and products. Renesas Technology Corp. assumes no responsibility for any damage, liability or other loss resulting from the information contained herein.
5. Renesas Technology Corp. semiconductors are not designed or manufactured for use in a device or system that is used under circumstances in which human life is potentially at stake. Please contact Renesas Technology Corp. or an authorized Renesas Technology Corp. product distributor when considering the use of a product contained herein for any specific purposes, such as apparatus or systems for transportation, vehicular, medical, aerospace, nuclear, or undersea repeater use.
6. The prior written approval of Renesas Technology Corp. is necessary to reprint or reproduce in whole or in part these materials.
7. If these products or technologies are subject to the Japanese export control restrictions, they must be exported under a license from the Japanese government and cannot be imported into a country other than the approved destination. Any diversion or reexport contrary to the export control laws and regulations of Japan and/or the country of destination is prohibited.
8. Please contact Renesas Technology Corp. for further details on these materials or the products contained therein.

RENESAS

RENESAS SALES OFFICES

<http://www.renesas.com>

Refer to "<http://www.renesas.com/en/network>" for the latest and detailed information.

Renesas Technology America, Inc.

450 Holger Way, San Jose, CA 95134-1368, U.S.A
Tel: <1> (408) 382-7500, Fax: <1> (408) 382-7501

Renesas Technology Europe Limited

Dukes Meadow, Millboard Road, Bourne End, Buckinghamshire, SL8 5FH, U.K.
Tel: <44> (1628) 585-100, Fax: <44> (1628) 585-900

Renesas Technology Hong Kong Ltd.

7th Floor, North Tower, World Finance Centre, Harbour City, 1 Canton Road, Tsimshatsui, Kowloon, Hong Kong
Tel: <852> 2265-6688, Fax: <852> 2730-6071

Renesas Technology Taiwan Co., Ltd.

10th Floor, No.99, Fushing North Road, Taipei, Taiwan
Tel: <886> (2) 2715-2888, Fax: <886> (2) 2713-2999

Renesas Technology (Shanghai) Co., Ltd.

Unit2607 Ruijing Building, No.205 Maoming Road (S), Shanghai 200020, China
Tel: <86> (21) 6472-1001, Fax: <86> (21) 6415-2952

Renesas Technology Singapore Pte. Ltd.

1 Harbour Front Avenue, #06-10, Keppel Bay Tower, Singapore 098632
Tel: <65> 6213-0200, Fax: <65> 6278-8001