

SPDT SWITCH GaAs MMIC

■ GENERAL DESCRIPTION

NJG1615HA8 is a SPDT switch IC featured low insertion loss, medium handling power and high isolation.

This device is suitable for switching of Tx/Rx signals at sub-microwave applications.

This switch exhibits wide frequency range from 100MHz to 6.0GHz at low operating voltage of 2.5V, and is operated up to 25dBm at 3.0V operating voltage.

An ultra small and ultra thin package of USB6-A8 is adopted. This product is RoHS directive compliant.

■ PACKAGE OUTLINE

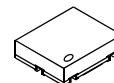

NJG1615HA8

■ FEATURES

- Single low voltage control +2.5~+6.5V
- Low insertion loss 0.40dB typ. @f=2.5GHz, P_{IN}=23dBm
0.55dB typ. @f=5.85GHz, P_{IN}=20dBm
- High isolation 25dB typ. @f=2.5GHz, P_{IN}=23dBm
- Handling power (P_{-1dB}) P_{-1dB}=30dBm typ. @f=2.5GHz, V_{CTL(H)}=3.0V
- Ultra small & ultra thin package USB6-A8 (Mount Size: 1.0x1.2x0.38mm)

■ PIN CONFIGURATION

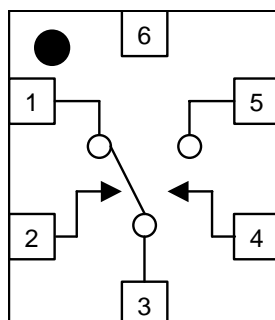

Pin connection

- 1.P2
- 2.VCTL2
- 3.PC
- 4.VCTL1
- 5.P1
- 6.GND

■ TRUTH TABLE

“H”=V_{CTL (H)}, “L”=V_{CTL (L)}

V _{CTL1}	H	L
V _{CTL2}	L	H
PC – P1	OFF	ON
PC – P2	ON	OFF

NJG1615HA8

■ ABSOLUTE MAXIMUM RATINGS

($T_a=25^\circ\text{C}$)

PARAMETER	SYMBOL	CONDITIONS	RATINGS	UNITS
Input Power	P_{in}	$V_{CTL(L)}=0\text{V}$, $V_{CTL(H)}=3.0\text{V}$	32	dBm
Control Voltage	V_{CTL}	$V_{CTL(H)}-V_{CTL(L)}$	7.5	V
Power Dissipation	P_D	At on PCB Board $T_{jmax}=150^\circ\text{C}$	150	mW
Operating Temp.	T_{opr}		-40~+85	$^\circ\text{C}$
Storage Temp.	T_{stg}		-55~+150	$^\circ\text{C}$

■ ELECTRICAL CHARACTERISTICS

($V_{CTL(L)}=0\text{V}$, $V_{CTL(H)}=3.0\text{V}$, $Z_S=Z_L=50\Omega$, $T_a=25^\circ\text{C}$)

PARAMETERS	SYMBOL	CONDITIONS	MIN	TYP	MAX	UNITS
Operating voltage (LOW)	$V_{CTL(L)}$		-0.2	0	0.2	V
Operating voltage (HIGH)	$V_{CTL(H)}$		2.5	3	6.5	V
Control current	I_{CTL}		-	5	10	μA
Insertion loss 1	LOSS1	$f=2.5\text{GHz}$, $P_{IN}=23\text{dBm}$	-	0.40	0.55	dB
Insertion loss 2	LOSS2	$f=5.85\text{GHz}$, $P_{IN}=20\text{dBm}$	-	0.55	0.75	dB
Isolation 1 (PC-P1, PC-P2, P1-P2)	ISL1	$f=2.5\text{GHz}$, $P_{IN}=23\text{dBm}$	22	25	-	dB
Isolation 2 (PC-P1, PC-P2, P1-P2)	ISL2	$f=5.85\text{GHz}$, $P_{IN}=20\text{dBm}$	12	15	-	dB
Pin at 1dB compression point(1)	$P_{-1dB(1)}$	$f=2.5\text{GHz}$	28	30	-	dBm
Pin at 1dB compression point(2)	$P_{-1dB(2)}$	$f=5.85\text{GHz}$	25	27	-	
VSWR (PC, P1, P2)	VSWR	$f=2.0\sim 5.85\text{GHz}$, ON state	-	1.4	1.6	
Switching time	T_{SW}	50% VCTL to 10/90% RF	-	70	200	ns

■ TERMINAL INFORMATION

No.	SYMBOL	DESCRIPTION
1	P2	RF port. This port is connected with PC port by controlling 2 nd pin ($V_{CTL(H)}$) to 2.5~6.5V and 4 th pin ($V_{CTL(L)}$) to -0.2~+0.2V. An external capacitor is required to block the DC bias voltage of internal circuit. (0.1~0.5GHz: 1000pF, 0.5~2GHz: 56pF, 2~5GHz: 27pF)
2	VCTL2	Control port 2. The voltage of this port controls PC to P2 state. The 'ON' and 'OFF' state is toggled by controlling voltage of this terminal such as high-state (2.5~6.5V) or low-state (-0.2~+0.2V). The voltage of 7 th pin have to be set to opposite state. The bypass capacitor has to be chosen to reduce switching time delay from 10pF~1000pF range.
3	PC	Common RF port. In order to block the DC bias voltage of internal circuit, an external capacitor is required. (0.1~0.5GHz: 1000pF, 0.5~2GHz: 56pF, 2~5GHz: 27pF)
4	VCTL1	Control port 1. The voltage of this port controls PC to P1 state. The 'ON' and 'OFF' state is toggled by controlling voltage of this terminal such as high-state (2.5~6.5V) or low-state (-0.2~+0.2V). The voltage of 5 th pin has to be set to opposite state. The bypass capacitor has to be chosen to reduce switching time delay from 10pF~1000pF range.
5	P1	RF port. This port is connected with PC port by controlling 7 th pin ($V_{CTL(H)}$) to 2.5~6.5V and 5 th pin ($V_{CTL(L)}$) to -0.2~+0.2V. An external capacitor is required to block the DC bias voltage of internal circuit(0.1~0.5GHz: 1000pF, 0.5~2GHz: 56pF, 2~5GHz: 27pF)
6	GND	Ground terminal. Please connect this terminal with ground plane as close as possible for excellent RF performance.

NJG1615HA8

■ ELECTRICAL CHARACTERISTICS (With Application circuit, Loss of external circuit are excluded)

Loss, ISL vs Frequency

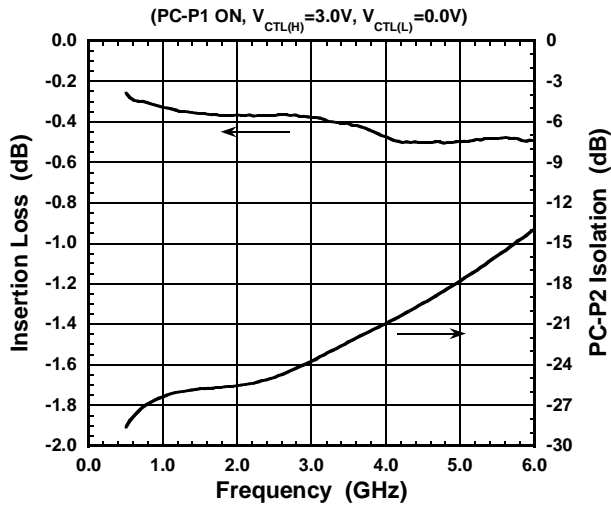

Loss, ISL vs Frequency

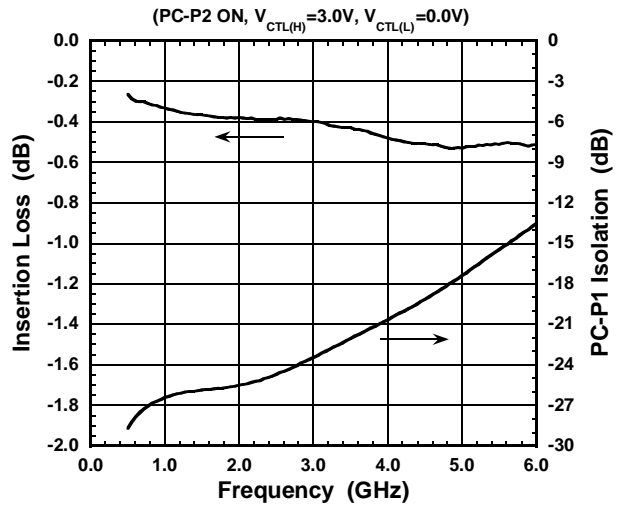

VSWR vs Frequency

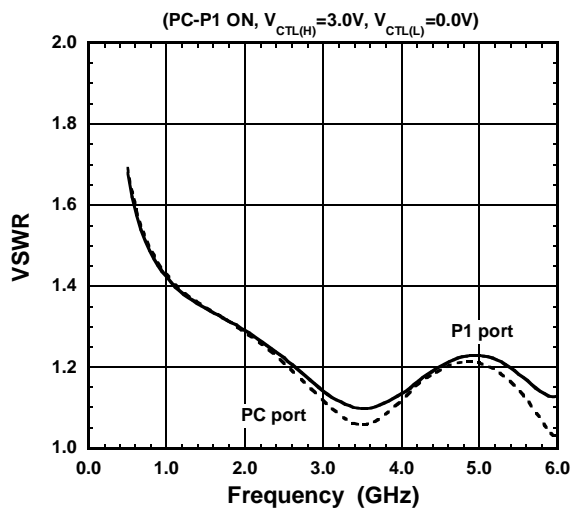

VSWR vs Frequency

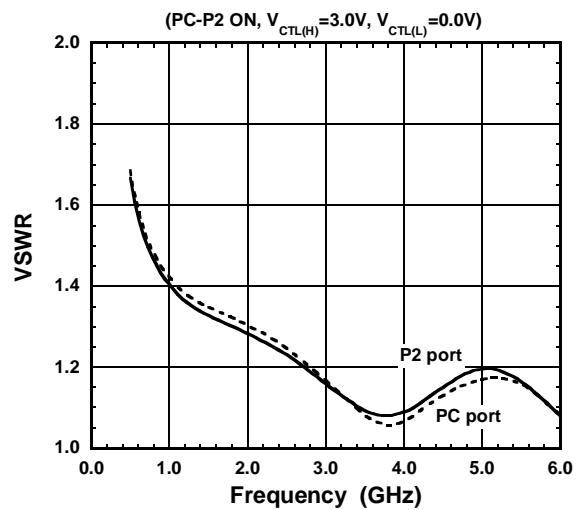

Switching Time

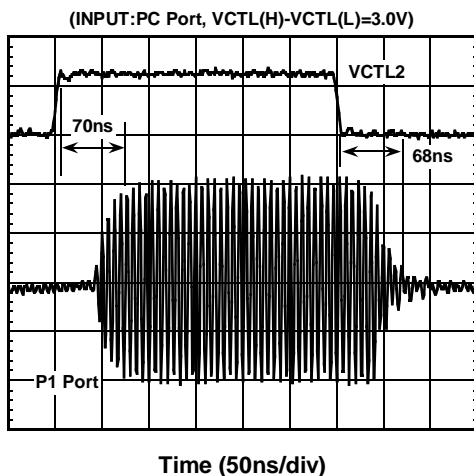

ELECTRICAL CHARACTERISTICS (With Application circuit, Loss of external circuit are excluded)

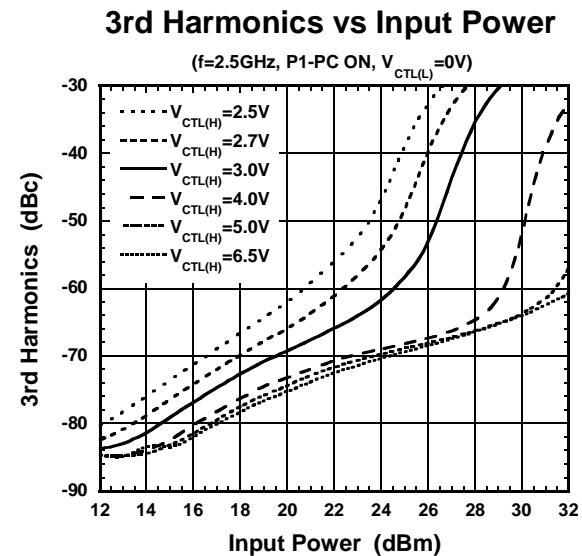
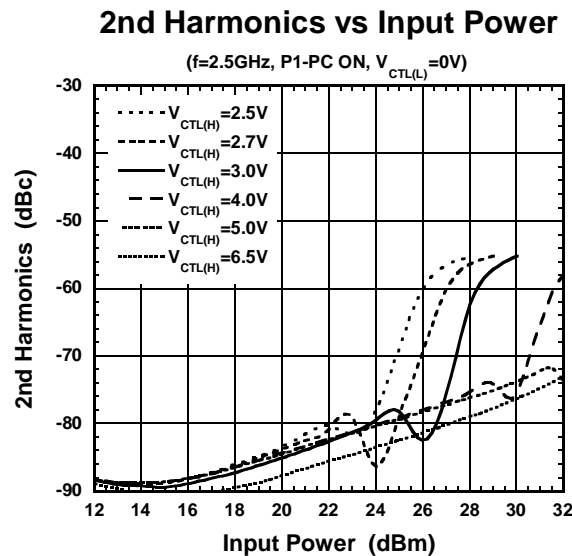
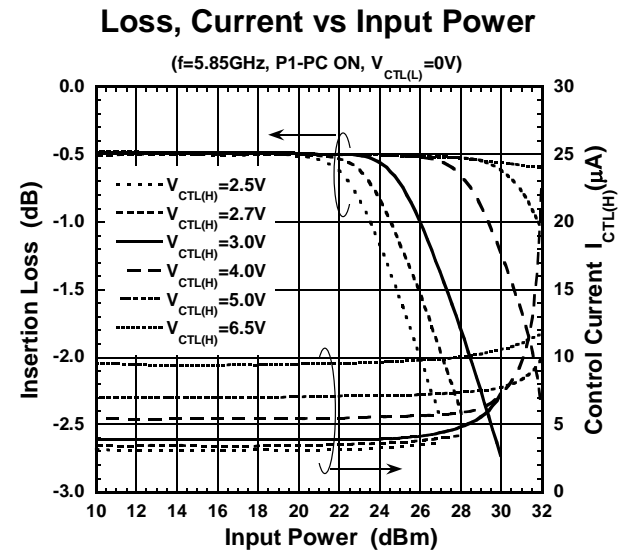
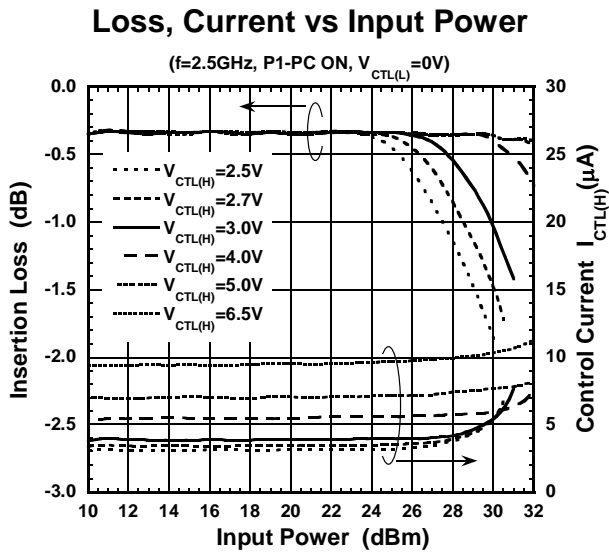
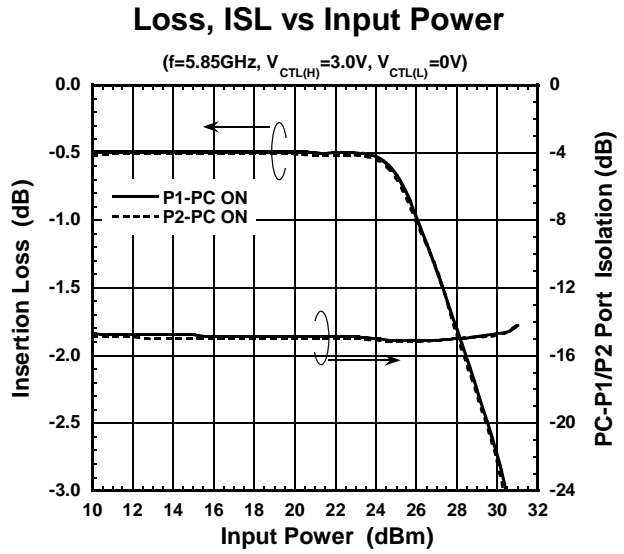
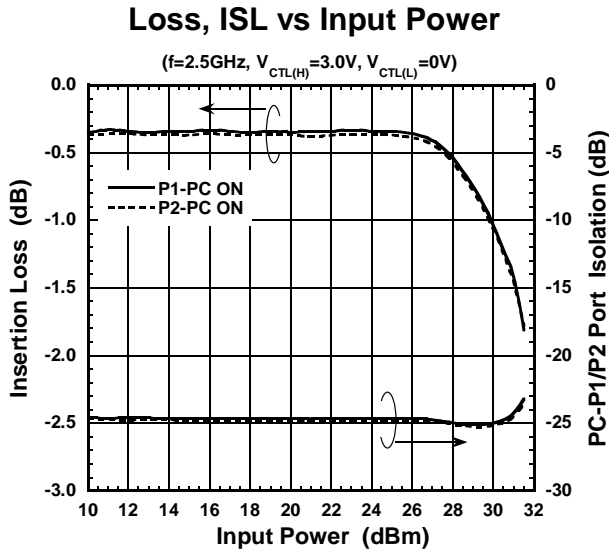

NJG1615HA8

APPLICATION CIRCUIT

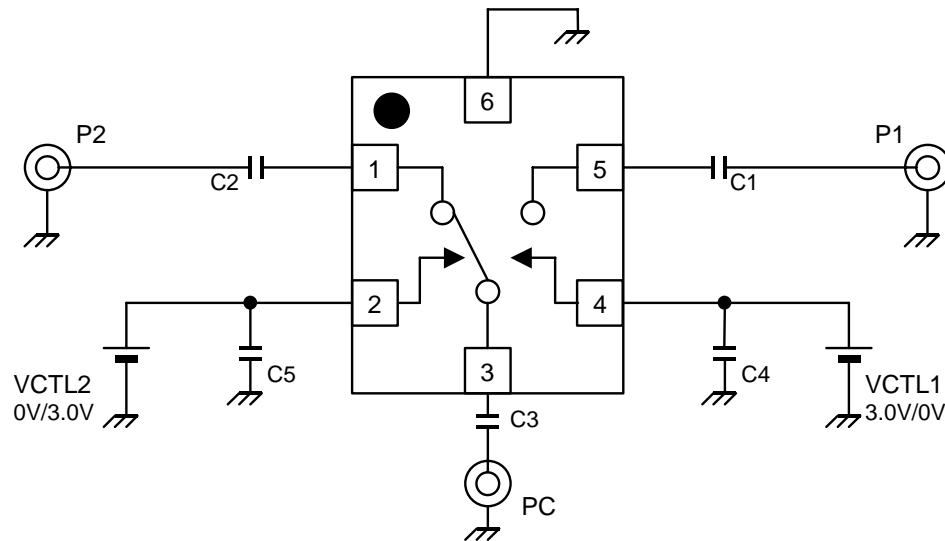

Parts List

Parts number	List 1	List 2	List 3	Notes
	$f_{in}=0.1\sim 0.5\text{GHz}$	$f_{in}=0.5\sim 2\text{GHz}$	$f_{in}=2\sim 6\text{GHz}$	
C1~C3	1000pF	56pF	27pF	GRM15 MURATA
C4, C5	10pF	10pF	10pF	GRM15 MURATA

RECOMMENDED PCB DESIGN

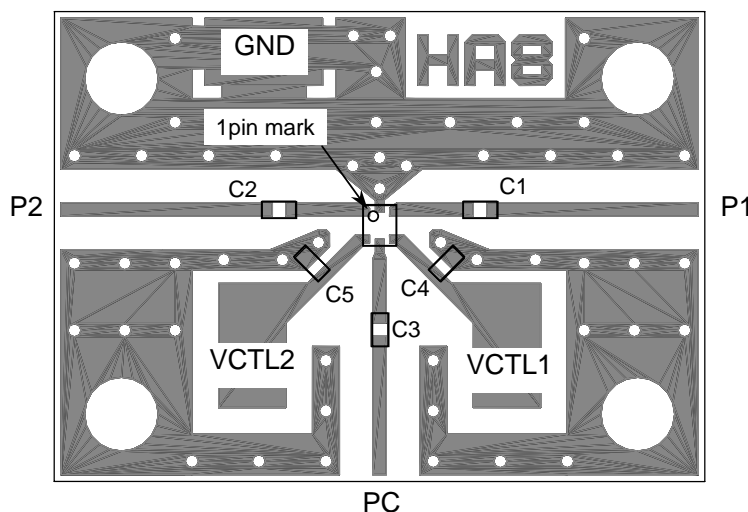

Circuit losses including losses of capacitor and connector.

(DC cut capacitor:27pF)

freq	Loss
2.5GHz	0.38dB
5.85GHz	0.83dB

PCB SIZE=19.4x14.0mm

PCB: FR-4, t=0.2mm

CAPACITOR: size 1005

Stipline =0.4mm

PRECAUTIONS

- [1] The DC blocking capacitors have to be placed at RF terminal of P1, P2 and PC.
- [2] To reduce stipline influence on RF characteristics, please locate bypass capacitors (C4, C5) close to each terminals.
- [3] For good isolation, the GND terminal (6th pin) must be placed possibly close to ground plane of substrate, and through holes for GND should be placed near by the pin connection.

PACKAGE OUTLINE (USB6-A8)

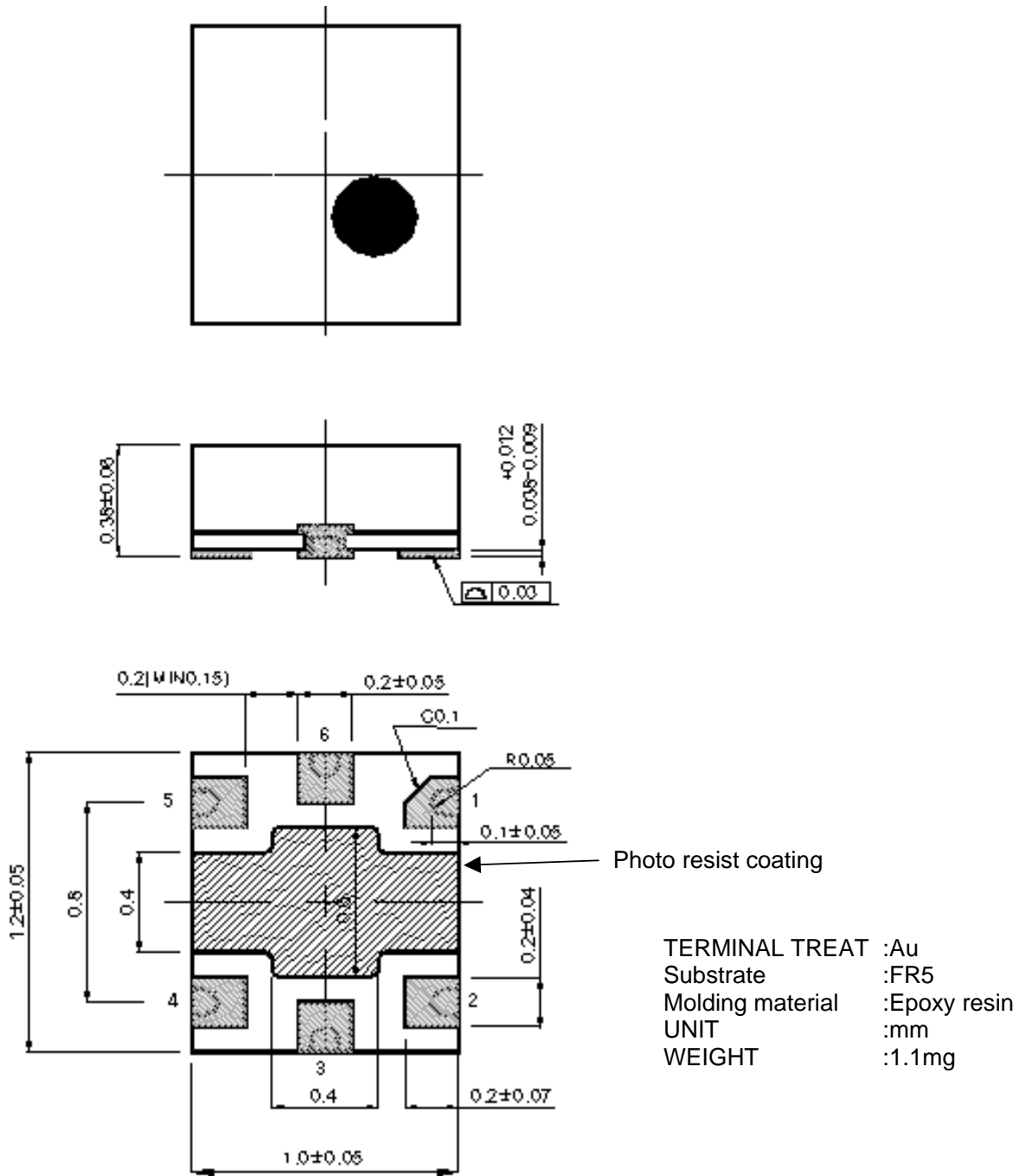

Cautions on using this product

- This product contains Gallium-Arsenide (GaAs) which is a harmful material.
- Do NOT eat or put into mouth.
 - Do NOT dispose in fire or break up this product.
 - Do NOT chemically make gas or powder with this product.
 - To waste this product, please obey the relating law of your country.

[CAUTION]

The specifications on this databook are only given for information, without any guarantee as regards either mistakes or omissions. The application circuits in this databook are described only to show representative usages of the product and not intended for the guarantee or permission of any right including the industrial rights.

This product may be damaged with electric static discharge (ESD) or spike voltage. Please handle with care to avoid these damages.