

SPDT SWITCH GaAs MMIC

■ GENERAL DESCRIPTION

NJG1600HB6 is a GaAs SPDT switch IC that features small-sized package and low insertion loss, and ideally suited for T/R switch of W-LAN or other digital wireless systems.

The ultra small & ultra thin USB8-B6 package is adopted.

■ PACKAGE OUTLINE

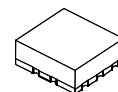

NJG1600HB6

■ FEATURES

- Low insertion loss
 - 0.45dB typ. @f=2.0GHz
 - 0.5dB typ. @f=2.5GHz
- High isolation
 - 20dB typ. @f=2.0GHz
 - 18dB typ. @f=2.5GHz
- Pin at 1dB compression point
 - 27dBm typ. @f=2.5GHz
- Low control current
 - 15uA typ.
- Ultra small & ultra thin package
 - USB8-B6 (Package size: 1.5x1.5x0.55mm)

■ PIN CONFIGURATION

USB8-B3 Type
(TOP VIEW)

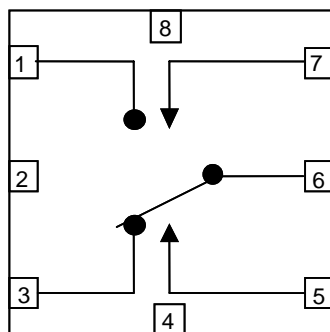

Pin connection

- 1.P1
- 2.GND
- 3.P2
- 4.GND
- 5.VCTL2
- 6.PC
- 7.VCTL1
- 8.GND

■ TRUTH TABLE

“H”=V_{CTL (H)}, “L”=V_{CTL (L)}

VCTL1	H	L
VCTL2	L	H
PC-P1	OFF	ON
PC-P2	ON	OFF

Note: Reversed logic version of this device is NJG1542HB3.

NJG1600HB6

■ ABSOLUTE MAXIMUM RATINGS

PARAMETER	SYMBOL	CONDITIONS	CONDITIONS	UNITS
RF Input Power	P_{IN}	$V_{CTL}=0V/3V$	29	dBm
Control Voltage	V_{CTL}	VCTL terminal	7.5	V
Operating Temp.	T_{opr}		-40~+85	°C
Storage Temp.	T_{stg}		-55~+150	°C

■ ELECTRICAL CHARACTERISTICS

(General conditions: $V_{CTL(L)}=0V$, $V_{CTL(H)}=3V$, $Z_S=Z_I=50\Omega$, $T_a=25^\circ C$)

PARAMETERS	SYMBOL	CONDITIONS	MIN	TYP	MAX	UNITS
Control Voltage (LOW)	$V_{CTL(L)}$		-0.2	-	0.2	V
Control Voltage (HIGH)	$V_{CTL(H)}$		2.5	3.0	6.5	V
Control Current	I_{CTL}	$f=2.5GHz$, $P_{IN}=18dBm$	-	15	30	μA
Insertion Loss 1	LOSS1	$f=2.0GHz$, $P_{IN}=18dBm$	-	0.45	0.6	dB
Insertion Loss 2	LOSS2	$f=2.5GHz$, $P_{IN}=18dBm$	-	0.5	0.65	dB
Isolation 1	ISL1	$f=2.0GHz$, $P_{IN}=18dBm$	17	20	-	dB
Isolation 2	ISL2	$f=2.5GHz$, $P_{IN}=18dBm$	15	18	-	dB
Pin at 1dB Compression Point 2	P_{-1dB}	$f=2.5GHz$	25	27	-	dBm
VSWR	VSWR	$f=0.1\sim 2.5GHz$, ON state	-	1.2	1.4	
Switching time	T_{SW}	$f=0.1\sim 2.5GHz$	-	20	100	ns

■ TERMINAL INFORMATION

No.	SYMBOL	DESCRIPTION
1	P1	RF port. This port is connected with PC port by controlling 5 th pin ($V_{CTL(H)}$) to 2.5~6.5V and 7 th pin ($V_{CTL(L)}$) to -0.2~+0.2V. An external capacitor is required to block the DC bias voltage of internal circuit. (100MHz: 0.01uF, 0.1~0.5GHz: 1000pF, 0.5~2.5GHz: 56pF)
2	GND	Ground terminal. Please connect this terminal with ground plane as close as possible for excellent RF performance.
3	P2	RF port. This port is connected with PC port by controlling 7 th pin ($V_{CTL(H)}$) to 2.5~6.5V and 5 th pin ($V_{CTL(L)}$) to -0.2~+0.2V. An external capacitor is required to block the DC bias voltage of internal circuit. (100MHz: 0.01uF, 0.1~0.5GHz: 1000pF, 0.5~2.5GHz: 56pF)
4	GND	Ground terminal. Please connect this terminal with ground plane as close as possible for excellent RF performance.
5	VCTL2	Control port 2. The voltage of this port controls PC to P2 state. The 'ON' and 'OFF' state is toggled by controlling voltage of this terminal such as high-state (2.5~6.5V) or low-state (-0.2~+0.2V). The voltage of 7 th pin have to be set to opposite state. The bypass capacitor has to be chosen to reduce switching time delay from 10pF~1000pF range.
6	PC	Common RF port. In order to block the DC bias voltage of internal circuit, an external capacitor is required. (100MHz:0.01uF, 0.1~0.5GHz: 1000pF, 0.5~2.5GHz: 56pF)
7	VCTL1	Control port 1. The voltage of this port controls PC to P1 state. The 'ON' and 'OFF' state is toggled by controlling voltage of this terminal such as high-state (2.5~6.5V) or low-state (-0.2~+0.2V). The voltage of 5 th pin have to be set to opposite state. The bypass capacitor has to be chosen to reduce switching time delay from 10pF~1000pF range.
8	GND	Ground terminal. Please connect this terminal with ground plane as close as possible for excellent RF performance.

NJG1600HB6

ELECTRICAL CHARACTERISTICS

(0.1~3.0GHz, with application circuit, without DC Blocking Capacitor, Losses of external circuit are excluded)

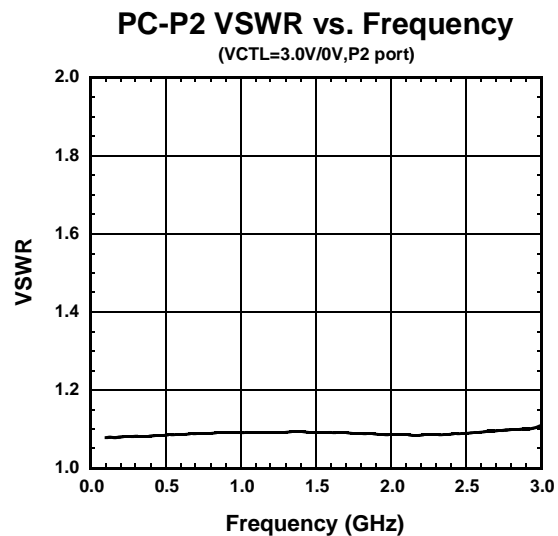
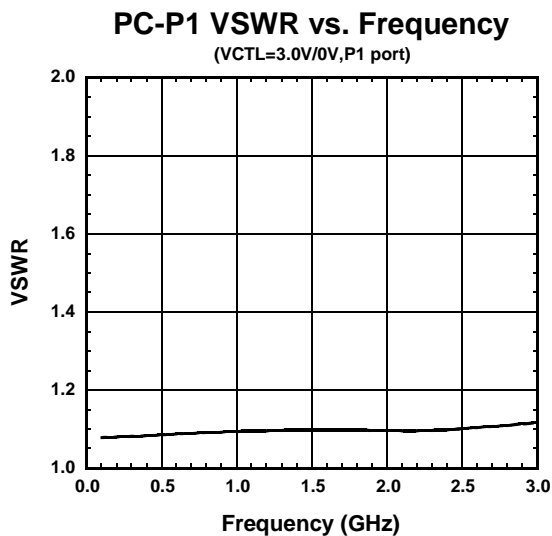
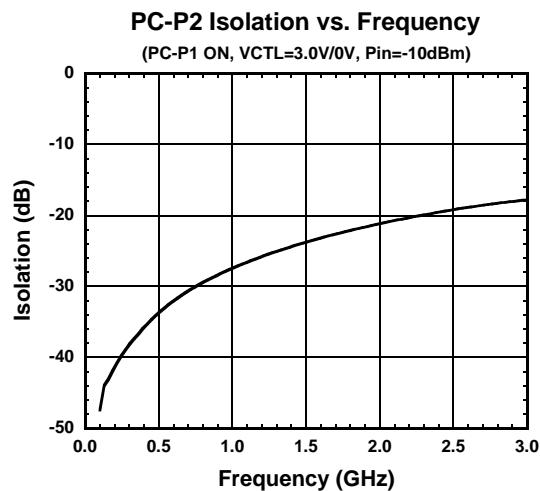
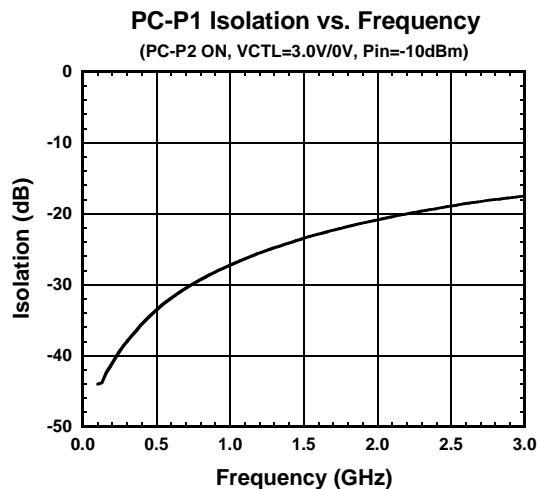
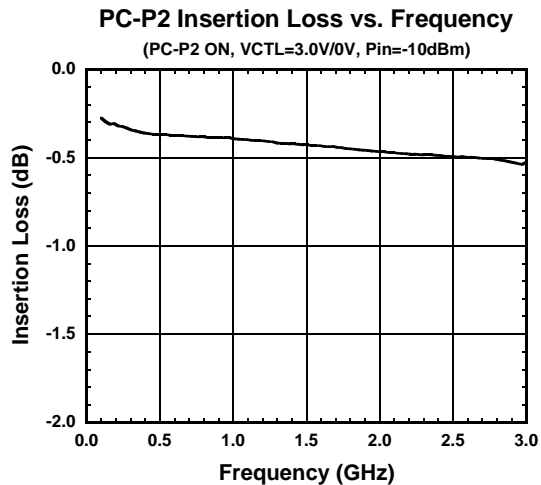
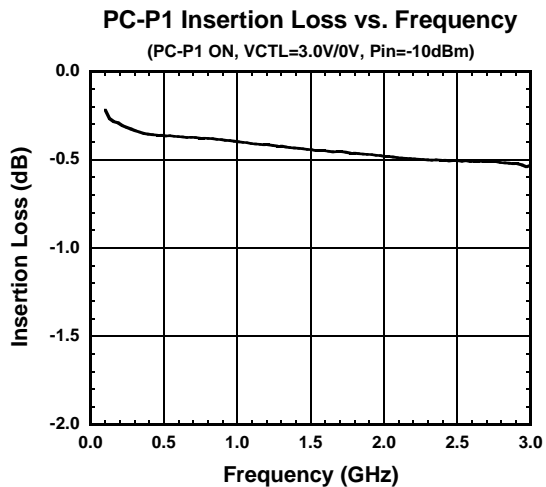

ELECTRICAL CHARACTERISTICS

(Application circuit (Parts list 2))

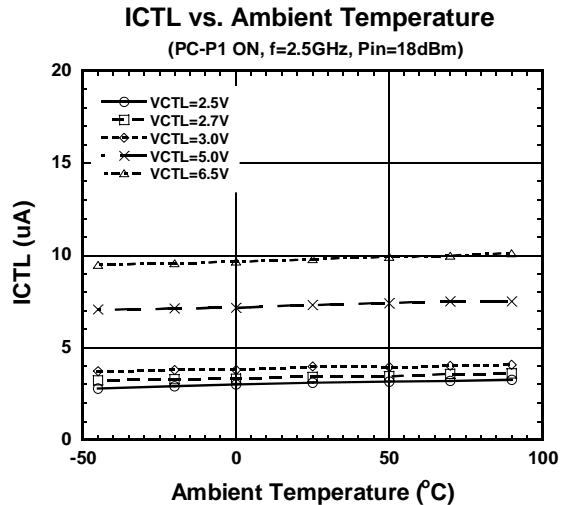
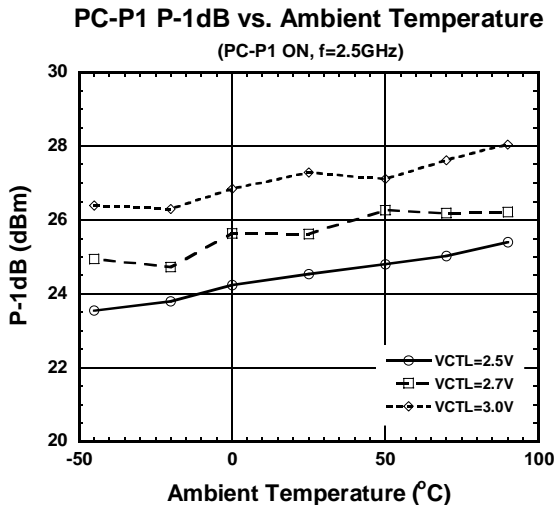
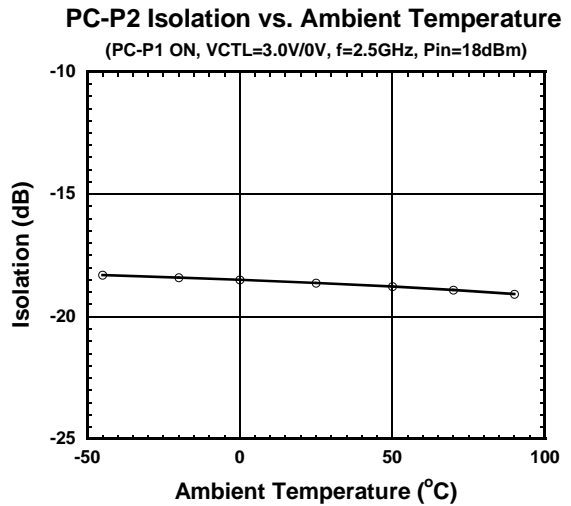
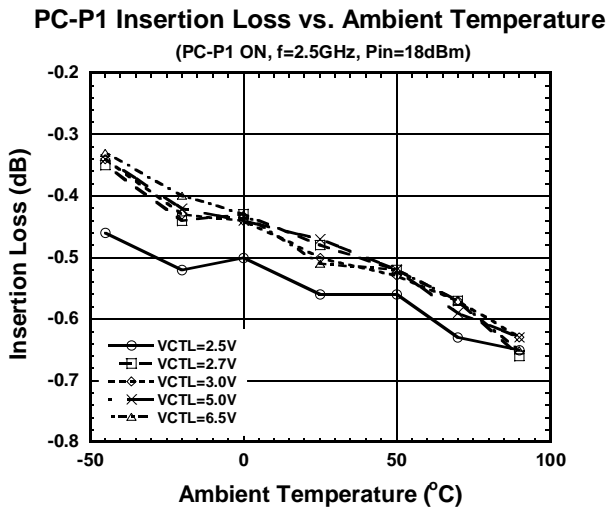
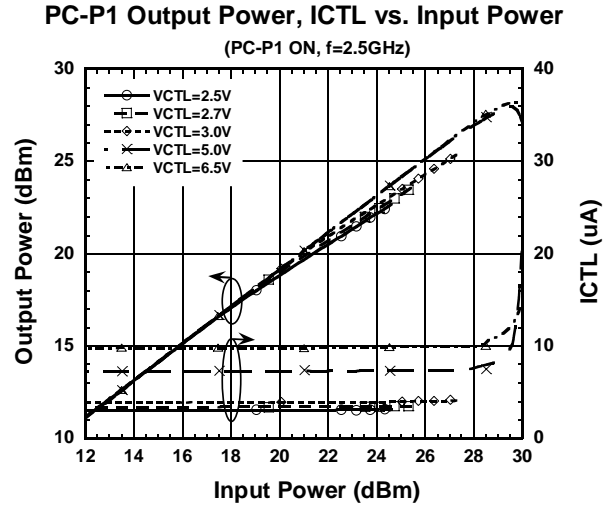
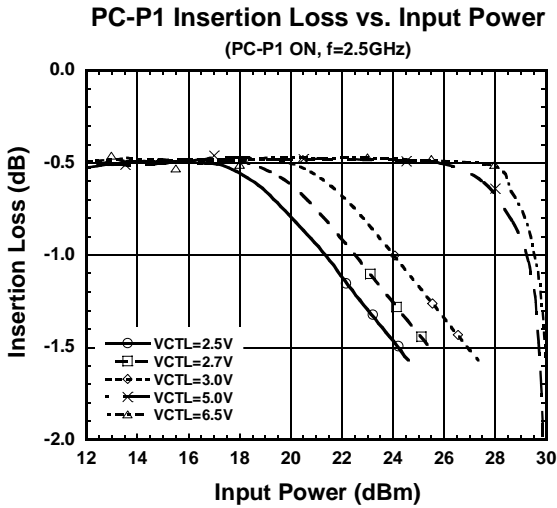

NJG1600HB6

APPLICATION CIRCUIT

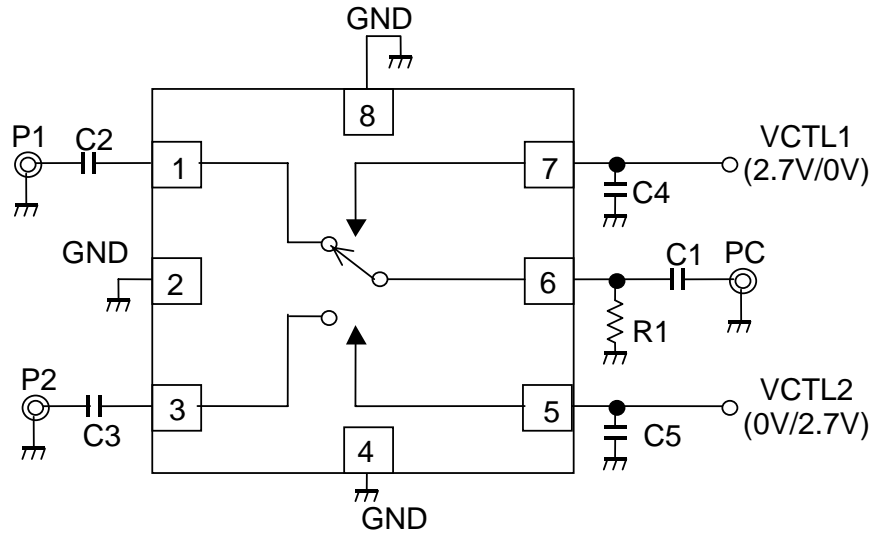

RECOMMENDED PCB DESIGN

(TOP VIEW)

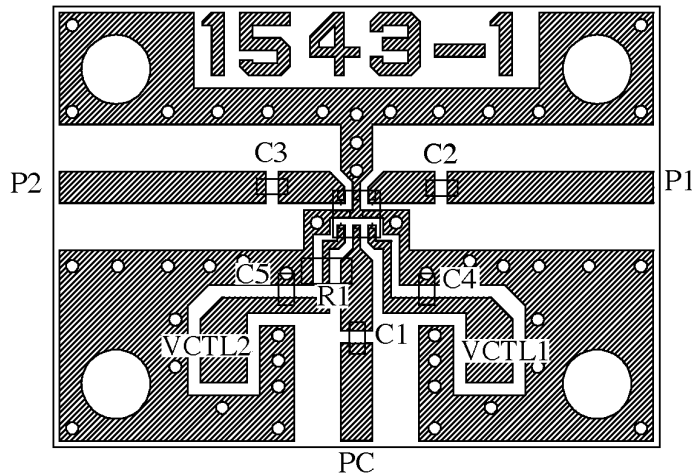

PCB:FR-4, t=0.5mm

Capacitor: Size 1005

Strip Line Width=1.0mm

PCB Size: 19.4x14.0mm

Circuit losses including losses of capacitors and connectors

freq (GHz)	Loss (dB)
0.8	0.11
1.0	0.12
1.5	0.16
1.8	0.19
2.0	0.21
2.5	0.27

PARTS LIST

No.	Parts list 1	Parts list 2
	f=0.1~0.5GHz	f=0.5~2.0GHz
R1 ^{*1}	560kΩ	560kΩ
C1~C3	1000pF	56pF
C4,C5	10pF	10pF

*1:1608 Size

PRECAUTIONS

- [1] The DC blocking capacitors have to be placed at RF terminal of P1, P2 and PC.
- [2] To reduce stipline influence on RF characteristics, please locate bypass capacitors (C4, C5) close to each terminals.
- [3] To avoid degradation of isolation or high power characteristics, please layout ground pattern right under this IC.

PACKAGE OUTLINE (USB8-B6)

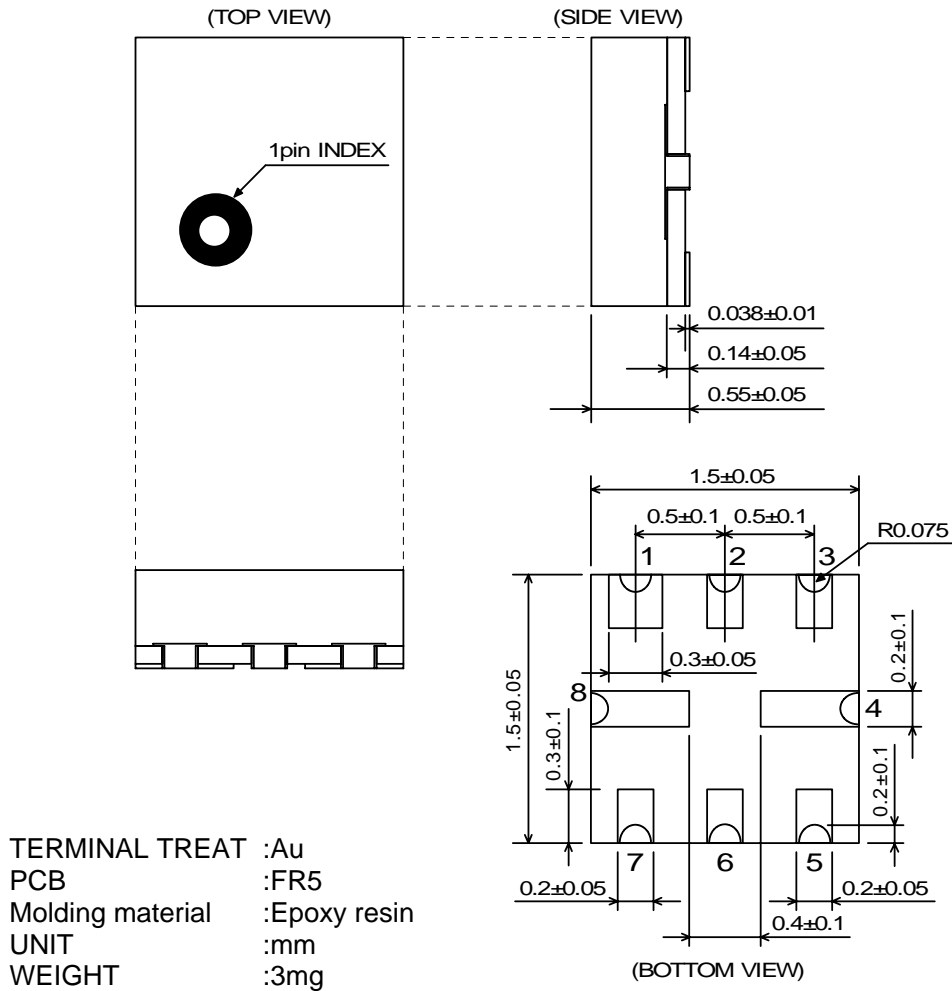

Cautions on using this product

This product contains Gallium-Arsenide (GaAs) which is a harmful material.

- Do NOT eat or put into mouth.
- Do NOT dispose in fire or break up this product.
- Do NOT chemically make gas or powder with this product.
- To waste this product, please obey the relating law of your country.

[CAUTION]

The specifications on this databook are only given for information, without any guarantee as regards either mistakes or omissions. The application circuits in this databook are described only to show representative usages of the product and not intended for the guarantee or permission of any right including the industrial rights.

This product may be damaged with electric static discharge (ESD) or spike voltage. Please handle with care to avoid these damages.