

GPS LOW NOISE AMPLIFIER GaAs MMIC

■ GENERAL DESCRIPTION

This IC is a Low noise amplifier GaAs MMIC designed for GPS. This amplifier provides low noise figure, high gain and high IP3 operated by single low positive power supply.

This amplifier can be tuned to wide frequency point (1.5GHz~2.4GHz).

An ultra-small and ultra-thin package of USB6-A8 is adopted.

■ PACKAGE OUTLINE

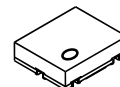

NJG1117HA8

■ FEATURES

- | | |
|---|--|
| ● Low voltage operation | +2.7V typ. |
| ● Low current consumption | 3.0mA typ. |
| ● High small signal gain | 19.5dB typ. @ f=1.575GHz |
| ● Low noise figure | 0.7dB typ. @ f=1.575GHz |
| ● Input power at 1dB gain compression point | -16.5 dBm typ. @f=1.575GHz |
| ● High input IP3 | -2.0dBm typ. @f=1.575GHz+1.5751GHz |
| ● Ultra-small & ultra-thin package | USB6-A8 (Package size: 1.0x1.2x0.38mm) |

■ PIN CONFIGURATION

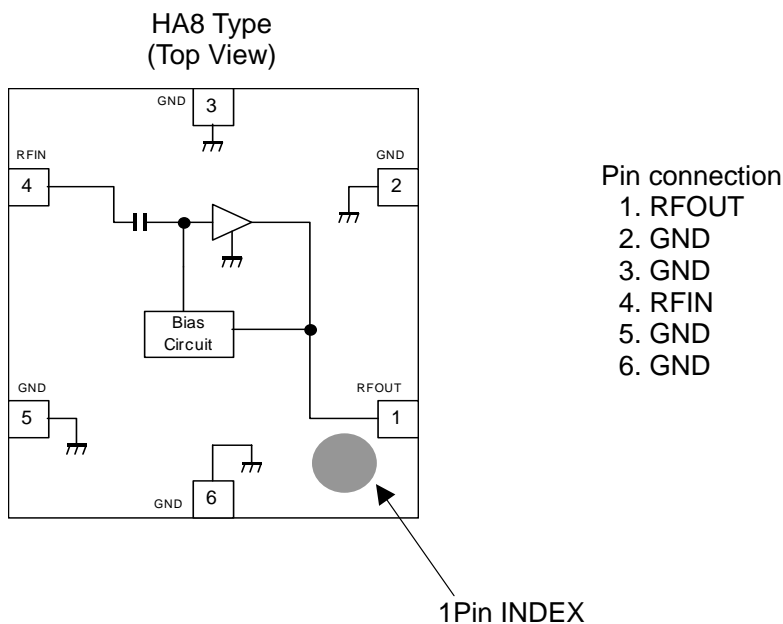

Note: Specifications and description listed in this datasheet are subject to change without notice.

NJG1117HA8

■ ABSOLUTE MAXIMUM RATINGS

$T_a=+25^{\circ}\text{C}$, $Z_s=Z_l=50\text{ ohm}$

PARAMETER	SYMBOL	CONDITIONS	RATINGS	UNITS
Drain Voltage	V_{DD}		5.0	V
Input power	P_{in}	$V_{DD}=2.7\text{V}$	+15	dBm
Power dissipation	P_D	On PCB board, $T_{jmax}=150^{\circ}\text{C}$	150	mW
Operating temperature	T_{opr}		-40~+85	$^{\circ}\text{C}$
Storage temperature	T_{stg}		-55~+150	$^{\circ}\text{C}$

■ ELECTRICAL CHARACTERISTICS

GENERAL CONDITIONS: $V_{DD}=2.7\text{V}$, $f_{RF}=1575\text{MHz}$, $T_a=+25^{\circ}\text{C}$, $Z_s=Z_l=50\text{ ohm}$, with application circuit.

PARAMETERS	SYMBOL	CONDITIONS	MIN	TYP	MAX	UNITS
Operating Frequency	freq		1.57	1.575	1.58	GHz
Operating voltage	V_{DD}		2.5	2.7	3.6	V
Operating current1	I_{DD}	RF OFF	-	3.0	4.0	mA
Small signal gain	Gain		17.5	19.5	22.0	dB
Noise figure	NF	Exclude PCB & connector losses (IN: 0.05dB)	-	0.7	1.0	dB
Input power at 1dB gain compression point	$P_{-1dB(IN)}$		-19.0	-16.5	-	dBm
Input 3rd order intercept point	IIP3	$f_1=f_{RF}$, $f_2=f_{RF}+100\text{kHz}$, $P_{in}=-34\text{dBm}$	-8.0	-2.0	-	dBm
RF IN VSWR	VSWR _i		-	2.0	2.5	
RF OUT VSWR	VSWR _o		-	1.5	2.0	

■ TERMINAL INFORMATION

No.	SYMBOL	DESCRIPTION
1	RFOUT	RF Output and voltage supply pin. An external output matching circuit and a bypass capacitor are required. L3 is a RF choke inductor. These elements are used as output matching circuit.
2	GND	Ground terminal. (0V)
3	GND	Ground terminal. (0V)
4	RFIN	RF input pin. A DC blocking capacitor is not required. An external input matching circuit is required.
5	GND	Ground terminal. (0V)
6	GND	Ground terminal. (0V)

CAUTION

1) Ground terminal (2, 3, 5, 6) should be connected with the ground plane as low inductance as possible.

NJG1117HA8

ELECTRICAL CHARACTERISTICS

(Conditions: $T_a=+25^\circ\text{C}$, $V_{DD}=2.7\text{V}$, $Z_s=Z_l=50\ \text{ohm}$, with application circuit.)

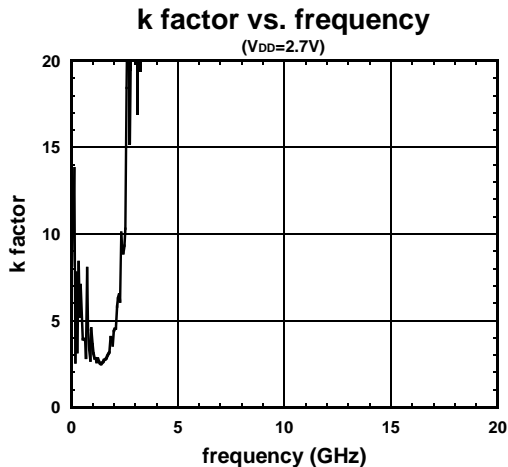
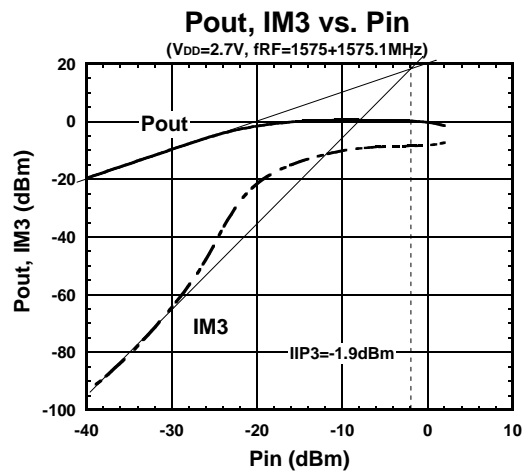
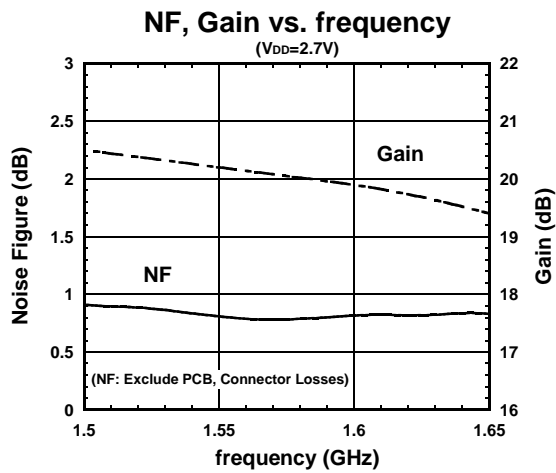
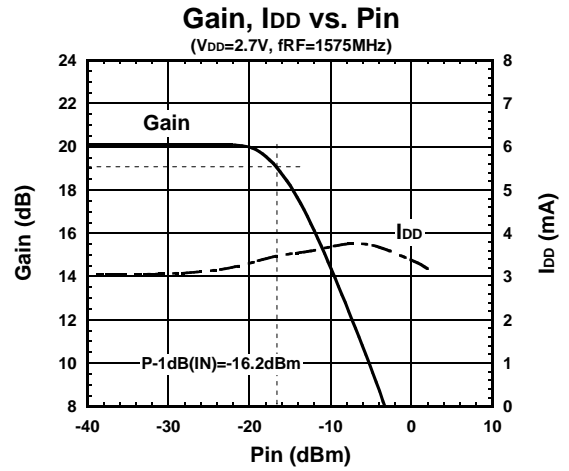
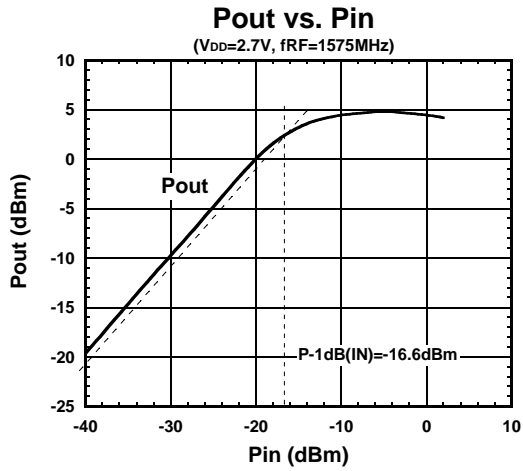

ELECTRICAL CHARACTERISTICS

(Conditions: $T_a=+25^{\circ}\text{C}$, $V_{DD}=2.7\text{V}$, $Z_s=Z_l=50\ \text{ohm}$, with application circuit.)

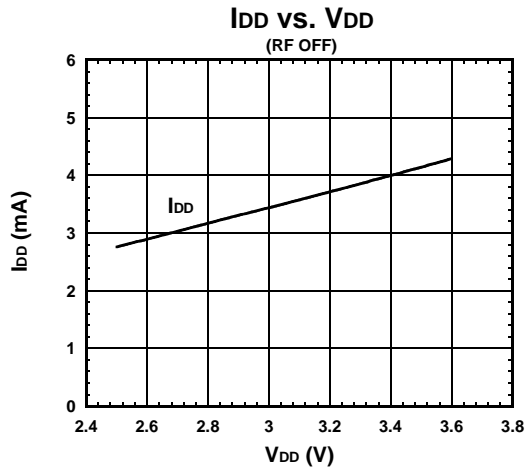
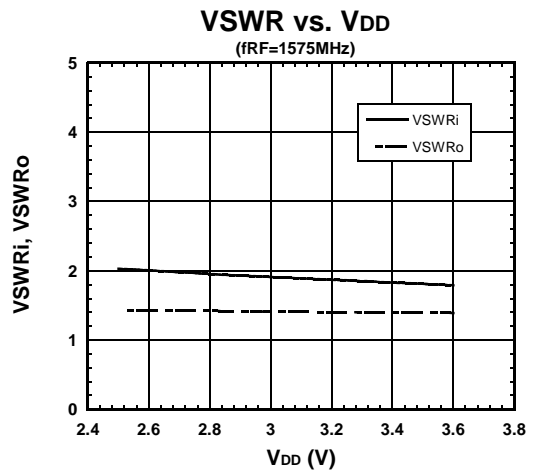
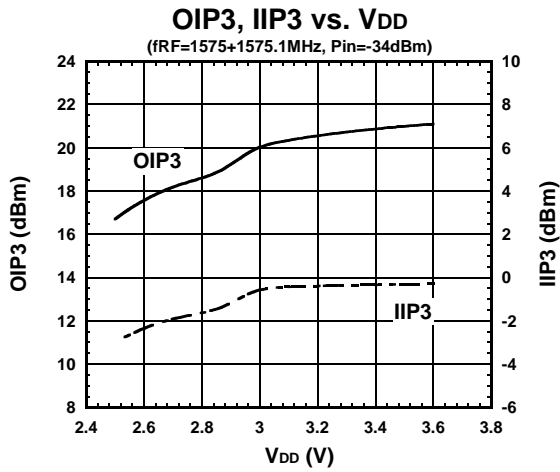
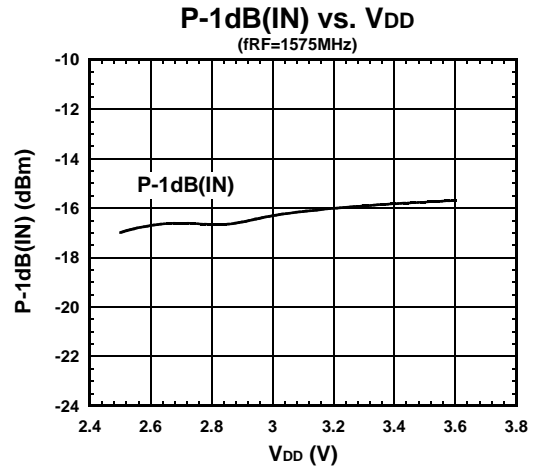
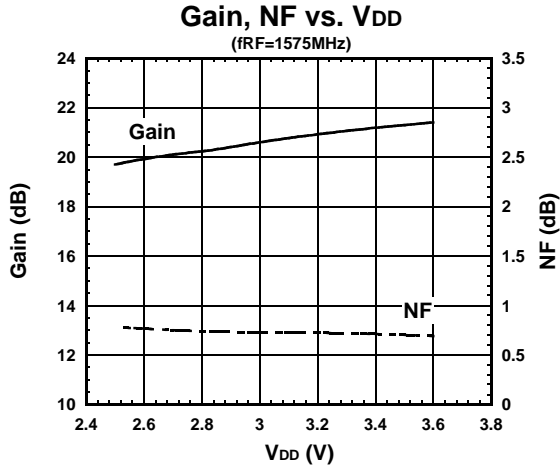

NJG1117HA8

■ ELECTRICAL CHARACTERISTICS

(Conditions: $T_a=+25^{\circ}\text{C}$, $V_{DD}=2.7\text{V}$, $Z_s=Z_l=50\text{ ohm}$, with application circuit.)

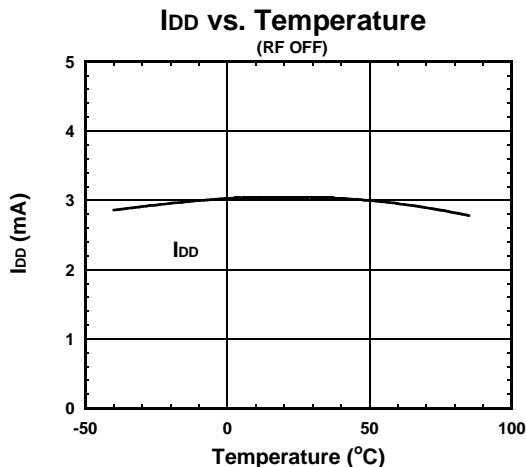
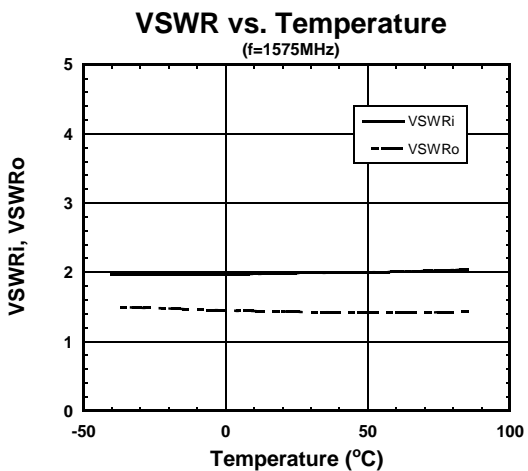
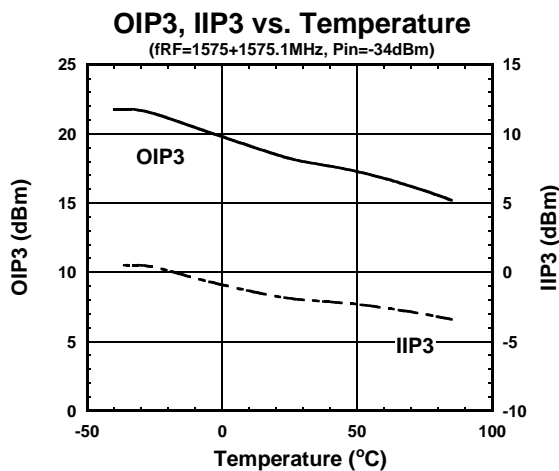
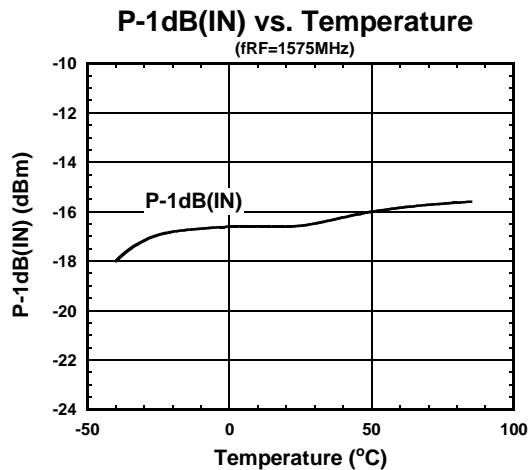
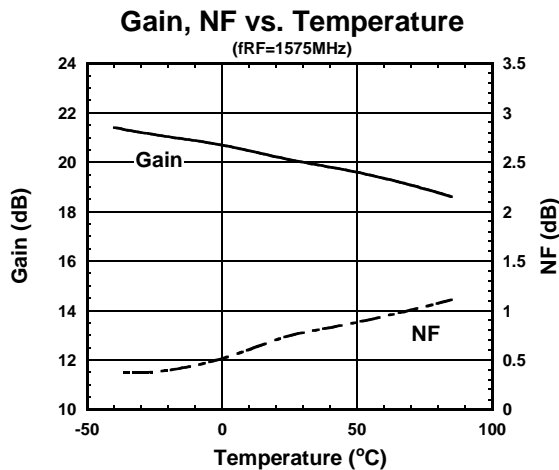

ELECTRICAL CHARACTERISTICS

(Conditions: $T_a=+25^{\circ}\text{C}$, $V_{DD}=2.7\text{V}$, $Z_s=Z_l=50\text{ ohm}$, with application circuit.)

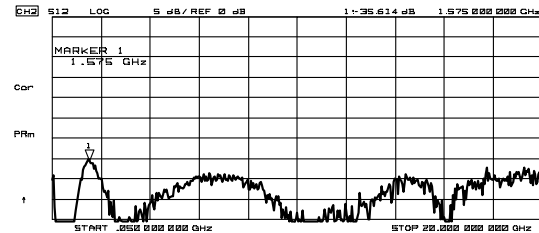
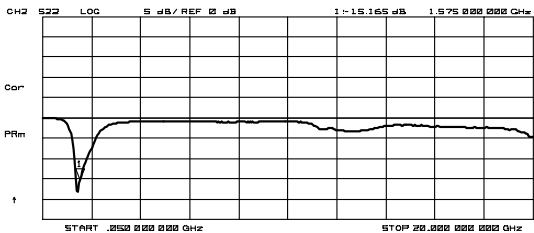
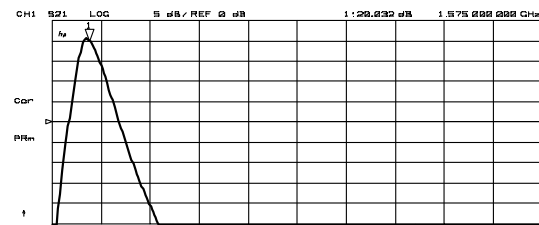
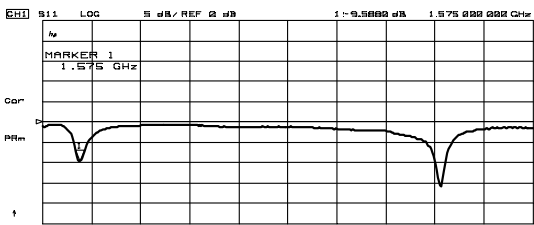
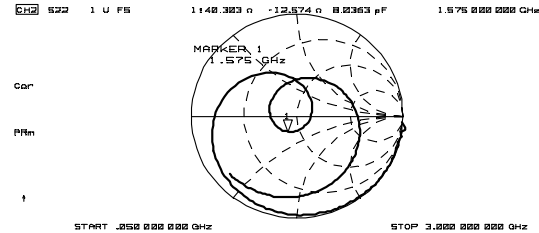
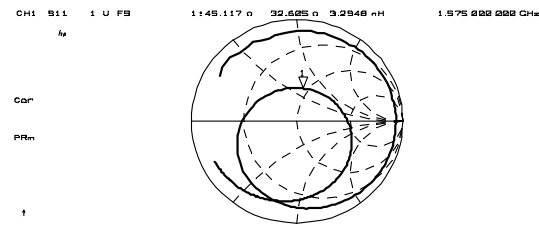
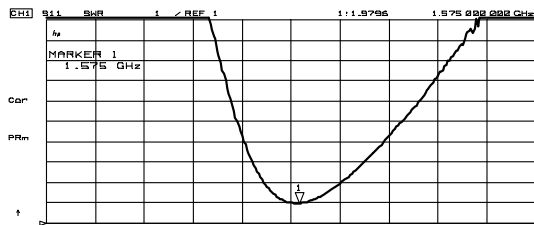
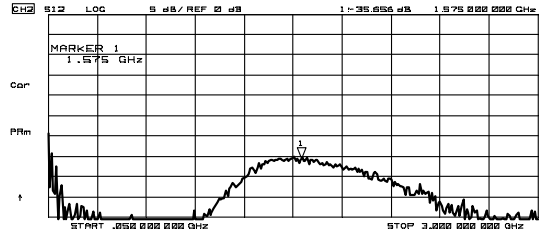
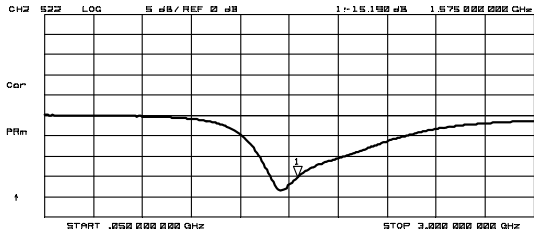
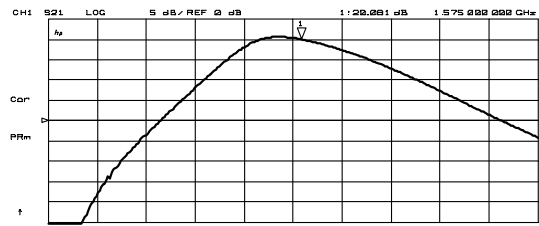
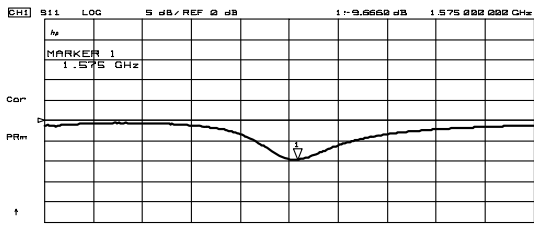

NJG1117HA8

APPLICATION CIRCUIT

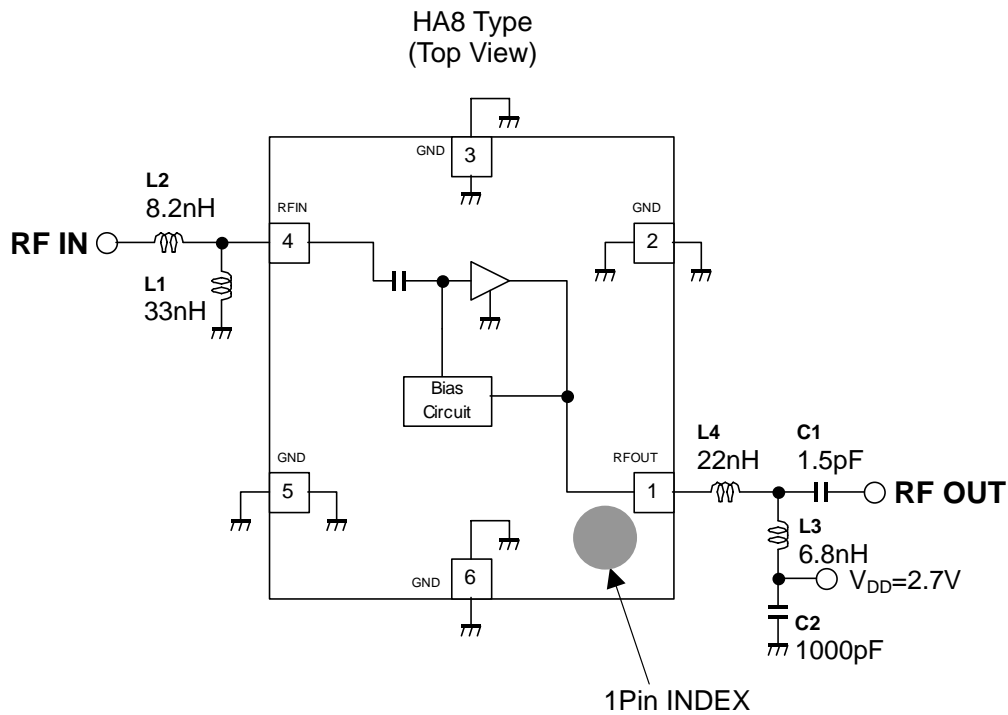

TEST PCB LAYOUT

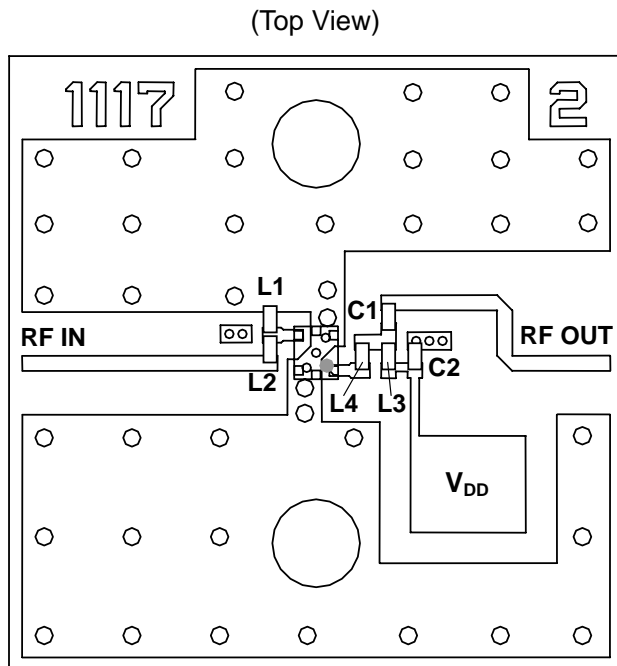

Parts list

Parts ID	Comment
L1 ~ L3	MURATA (LQP03T Series)
L4	TDK (MLK0603 Series)
C1 ~ C2	MURATA (GRM03 Series)

PCB (FR-4):
 t=0.2mm
 MICROSTRIP LINE WIDTH
 =0.34mm (Z₀=50 ohm)
 PCB SIZE=14.0mm x 14.0mm

PRECAUTION:

In order to prevent stability degradation in high frequency range, please prepare ground plane between terminal 4(RFIN) and terminal 1(RFOUT).

MEASUREMENT BLOCK DIAGRAM

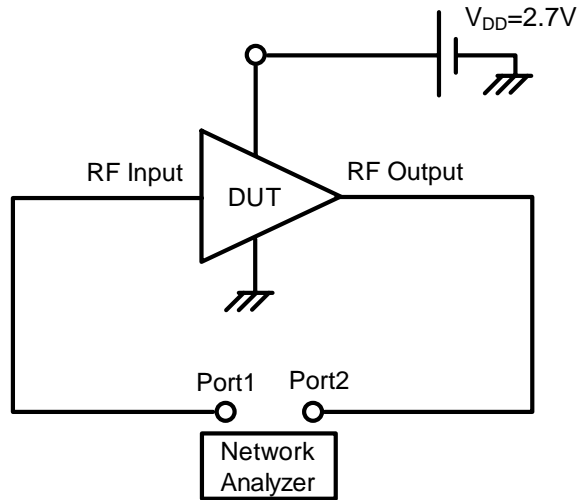

S parameter Measurement Block Diagram

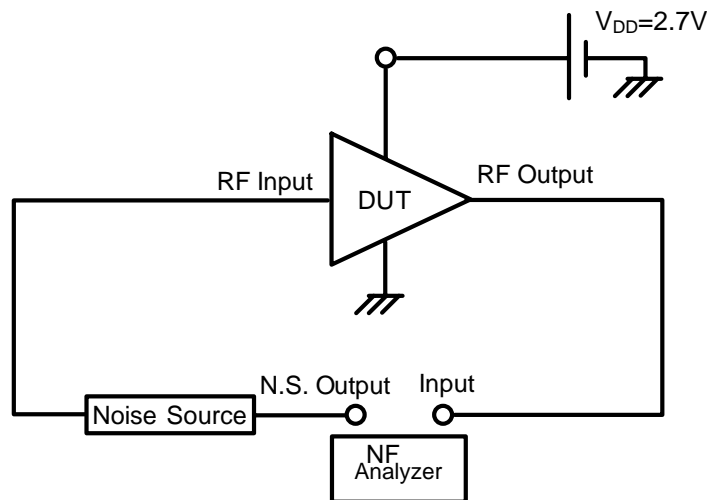

Noise Figure Measurement Block Diagram

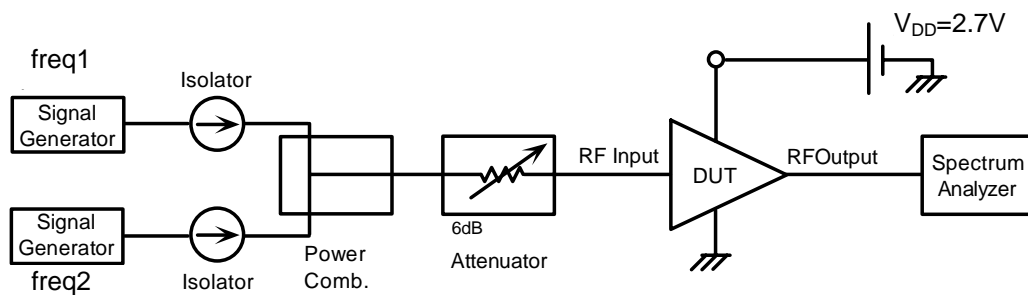

IIP3 Measurement Block Diagram

NJG1117HA8

PACKAGE OUTLINE (USB6-A8)

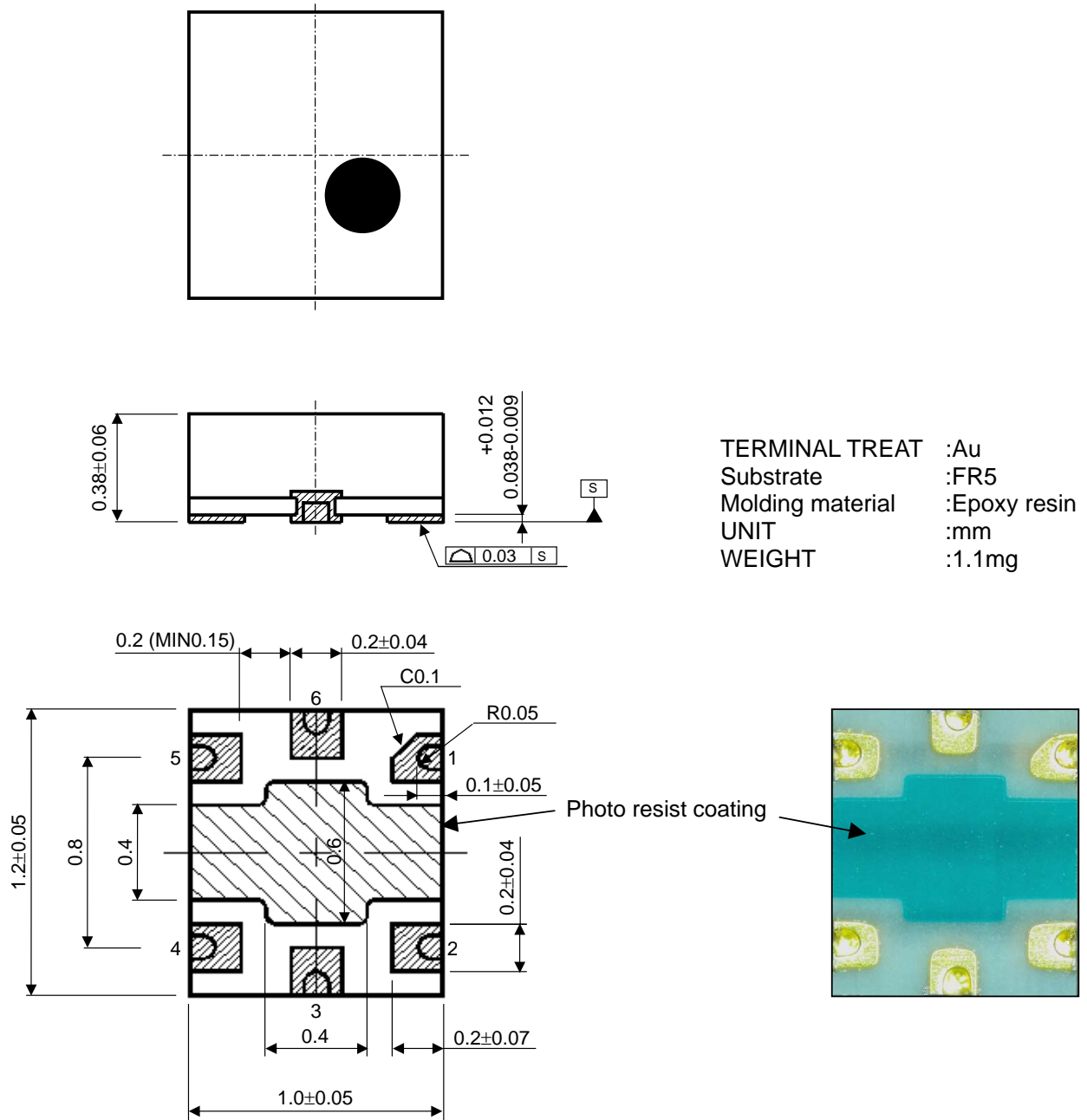

Cautions on using this product

- This product contains Gallium-Arsenide (GaAs) which is a harmful material.
- Do NOT eat or put into mouth.
 - Do NOT dispose in fire or break up this product.
 - Do NOT chemically make gas or powder with this product.
 - To waste this product, please obey the relating law of your country.

[CAUTION]

The specifications on this databook are only given for information, without any guarantee as regards either mistakes or omissions. The application circuits in this databook are described only to show representative usages of the product and not intended for the guarantee or permission of any right including the industrial rights.

This product may be damaged with electric static discharge (ESD) or spike voltage. Please handle with care to avoid these damages.