

## GPS LOW NOISE AMPLIFIER GaAs MMIC

### ■ GENERAL DESCRIPTION

The NJG1144KA1 is a low noise amplifier GaAs MMIC designed for GPS, GALILEO, and GLONASS. This amplifier achieves high gain and a good balance between ultra-low noise figure and excellent VSWR, while low current consumption and high IP3, respectively.

The NJG1144KA1 operates from +1.5V to +3.6V supply voltage range and current consumes is as low as 3.5mA.

An ultra-small and easy mounting package of FLP6-A1 is adopted.

### ■ PACKAGE OUTLINE

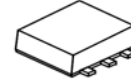

NJG1144KA1

### ■ FEATURES

- Wide supply voltage range 1.5V~3.6V
- Low current consumption 3.5mA typ. @  $V_{DD}=2.85V$   
1.8mA typ. @  $V_{DD}=1.8V$
- High gain 21.0dB typ. @  $f=1575MHz, V_{DD}=2.85V$
- Low noise figure 0.65dB typ. @  $f=1575MHz, V_{DD}=2.85V$
- High Input IP3 -2.0dBm typ. @  $f=1575MHz, V_{DD}=2.85V$
- Small package FLP6-A1 (package size: 1.6mm x 1.6mm x 0.55mm typ.)
- Lead -free and halogen-free

### ■ PIN CONFIGURATION

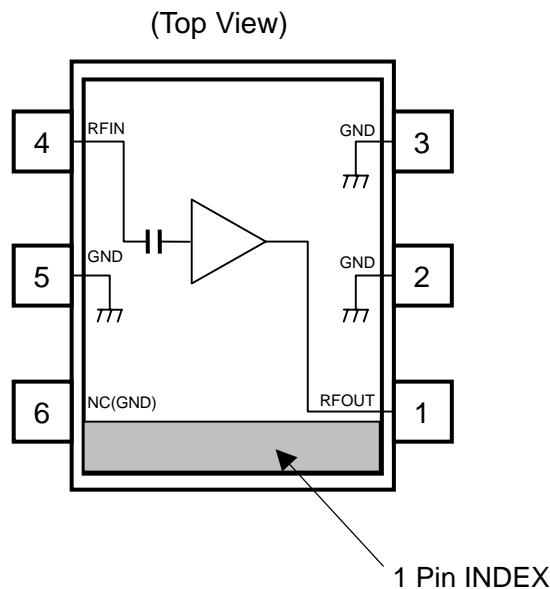

- Pin connection
1. RFOUT
  2. GND
  3. GND
  4. RFIN
  5. GND
  6. NC(GND)

Note: Specifications and description listed in this datasheet are subject to change without notice.

## ■ ABSOLUTE MAXIMUM RATINGS

$T_a=+25^{\circ}\text{C}$ ,  $Z_s=Z_i=50\ \text{ohm}$

PARAMETERS	SYMBOL	CONDITIONS	RATINGS	UNITS
Supply voltage	$V_{DD}$		5.0	V
Input power	$P_{IN}$	$V_{DD}=2.85\text{V}$	+15	dBm
Power dissipation	$P_D$	4-layer FR4 PCB with through-hole (74.2mmx74.2mm), $T_j=150^{\circ}\text{C}$	580	mW
Operating temperature	$T_{opr}$		-40~+85	$^{\circ}\text{C}$
Storage temperature	$T_{stg}$		-55~+150	$^{\circ}\text{C}$

## ■ ELECTRICAL CHARACTERISTICS 1 (DC)

(General conditions:  $V_{DD}=2.85\text{V}$ ,  $T_a=+25^{\circ}\text{C}$ )

PARAMETER	SYMBOL	CONDITIONS	MIN	TYP	MAX	UNIT
Supply Voltage	$V_{DD}$		1.5	-	3.6	V
Supply Current 1	$I_{DD1}$	RF OFF, $V_{DD}=2.85\text{V}$	-	3.5	5.5	mA
Supply Current 2	$I_{DD2}$	RF OFF, $V_{DD}=1.8\text{V}$	-	1.8	3.2	mA

## ■ ELECTRICAL CHARACTERISTICS 2 (RF)

(General conditions:  $V_{DD}=2.85V$ ,  $f_{RF}=1.575GHz$ ,  $T_a=+25^{\circ}C$ ,  $Z_s=Z_l=50ohm$ , with application circuit)

PARAMETER	SYMBOL	CONDITIONS	MIN	TYP	MAX	UNIT
Operating Frequency	freq		1.570	1.575	1.580	GHz
Operating Current 1	$I_{DD1}$	RF OFF	-	3.5	5.5	mA
Small signal Gain	Gain 1		18.0	21.0	23.5	dB
Noise Figure	NF1	Exclude PCB, Connector Losses(0.08dB)	-	0.65	0.95	dB
Input Power at 1dB Gain Compression Point 1	P-1dB(IN)1		-19.0	-16.5	-	dBm
Input 3 <sup>rd</sup> Order Intercept Point 1	IIP3_1	$f1=f_{RF}$ , $f2=f1+100kHz$ , $Pin=-34dBm$	-5.0	-2.0	-	dBm
RF Input VSWR 1	$VSWR_i1$		-	1.5	2.0	
RF Output VSWR 1	$VSWR_o1$			1.5	2.0	

## ■ ELECTRICAL CHARACTERISTICS 3 (RF)

(General conditions:  $V_{DD}=1.8V$ ,  $f_{RF}=1.575GHz$ ,  $T_a=+25^{\circ}C$ ,  $Z_s=Z_l=50ohm$ , with application circuit)

PARAMETER	SYMBOL	CONDITIONS	MIN	TYP	MAX	UNIT
Operating Frequency	freq		1.570	1.575	1.580	GHz
Operating Current 2	$I_{DD2}$	RF OFF	-	1.8	3.2	mA
Small Signal Gain 2	Gain 2		-	18.0	-	dB
Noise Figure 2	NF 2	Exclude PCB, Connector Losses(0.08dB)	-	0.85	-	dB
Input Power at 1dB Gain Compression Point 2	P-1dB(IN) 2		-	-18.5	-	dBm
Input 3 <sup>rd</sup> Order Intercept Point 2	IIP3_2	$f1=f_{RF}$ , $f2=f1+100kHz$ , $Pin=-34dBm$	-	-6.0	-	dBm
RF Input VSWR 2	$VSWR_i2$		-	1.8	-	
RF Output VSWR 2	$VSWR_o2$		-	1.8	-	

## ■ TERMINAL INFORMATION

No.	SYMBOL	DESCRIPTION
1	RFOUT	RF output and voltage supply terminal.
2	GND	Ground terminal (0V), Connect to the PCB ground plane.
3	GND	Ground terminal (0V), Connect to the PCB ground plane.
4	RFIN	RF input terminal. DC blocking capacitor is not required. An external matching circuit is required.
5	GND	Ground terminal (0V), Connect to the PCB ground plane.
6	NC(GND)	No connected terminal. This terminal is not connected with internal circuit. Please connect to the PCB ground Plane.

## ■ ELECTRICAL CHARACTERISTICS ( $V_{DD}=2.85V$ )

(Conditions:  $T_a=+25^{\circ}C$ ,  $V_{DD}=2.85V$ ,  $Z_s=Z_l=50\ \text{ohm}$ , with application circuit.)

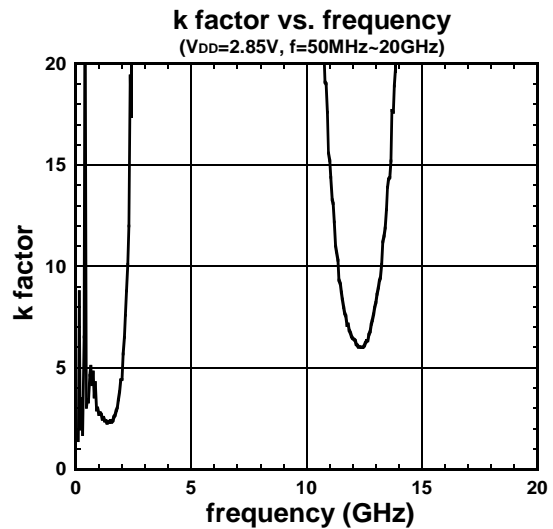
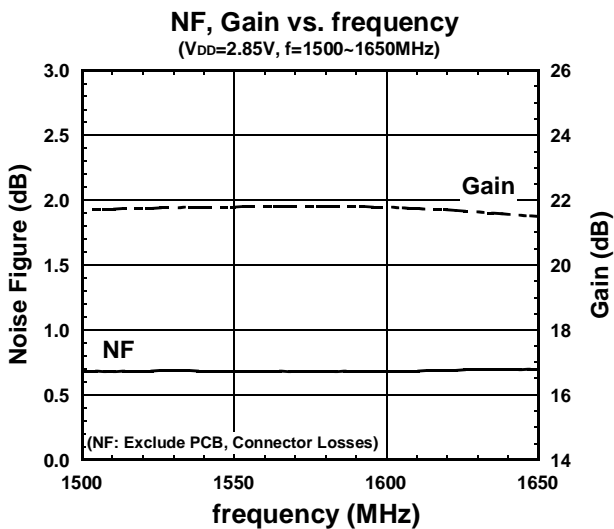
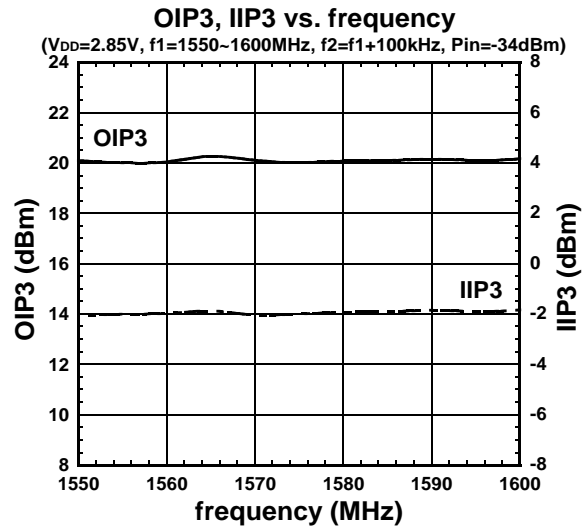
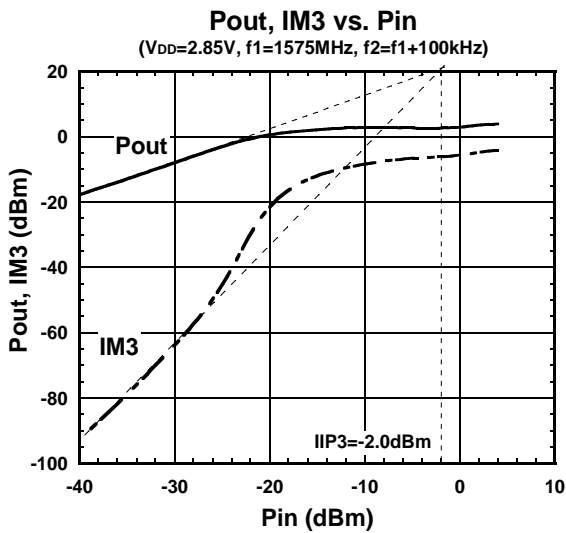
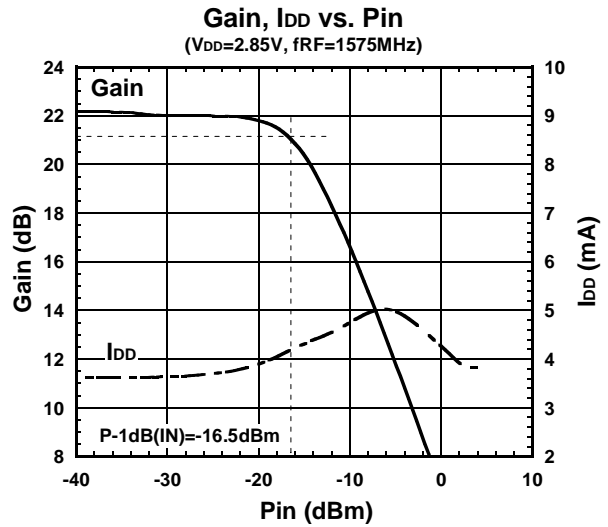
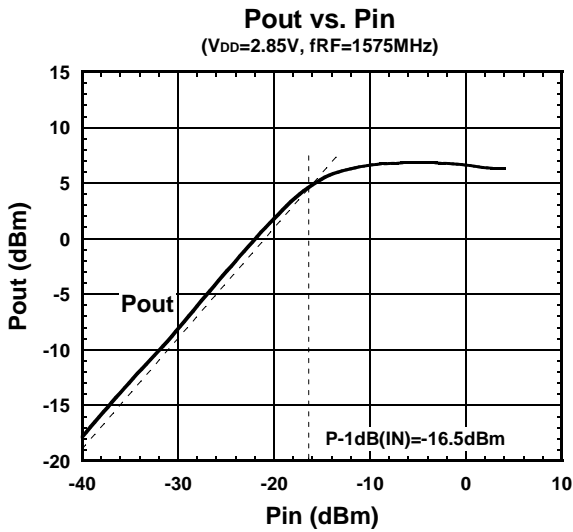

## ■ ELECTRICAL CHARACTERISTICS (V<sub>DD</sub>=2.85V)

(Conditions: V<sub>DD</sub>=2.85V, Z<sub>S</sub>=Z<sub>L</sub>=50 ohm, with application circuit.)

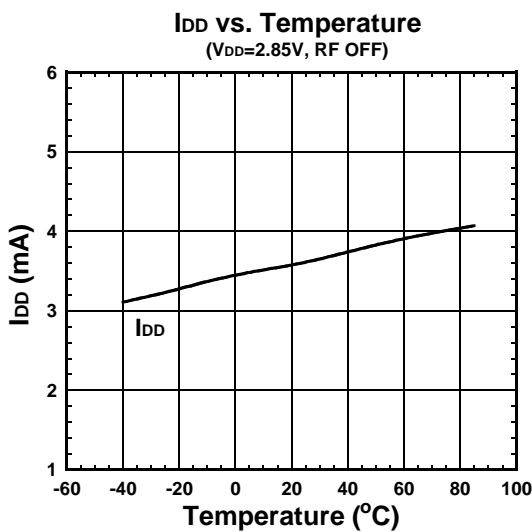
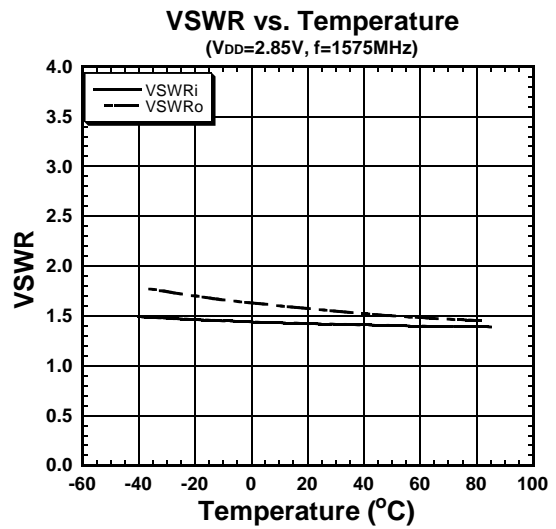
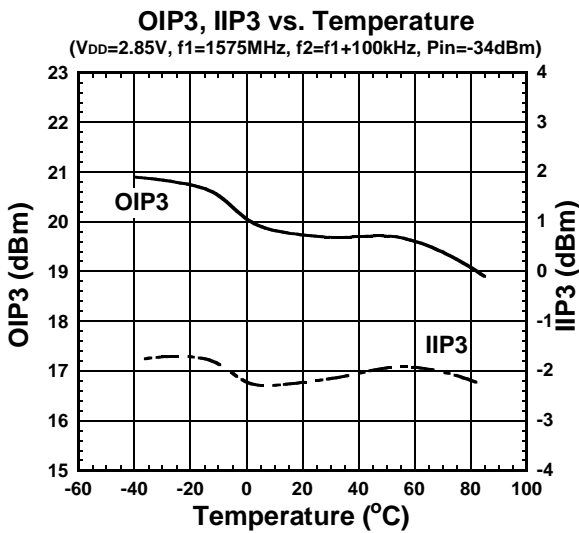
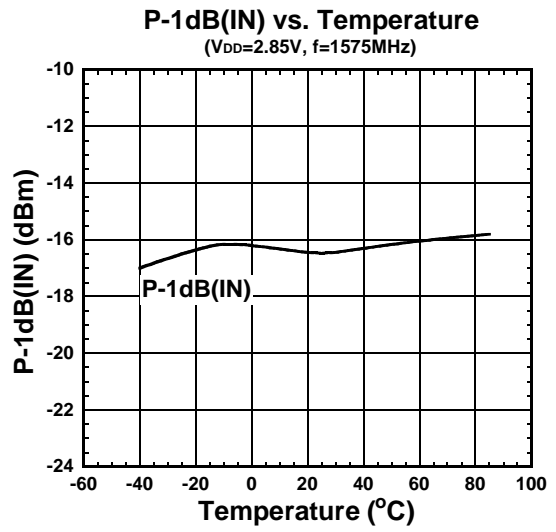
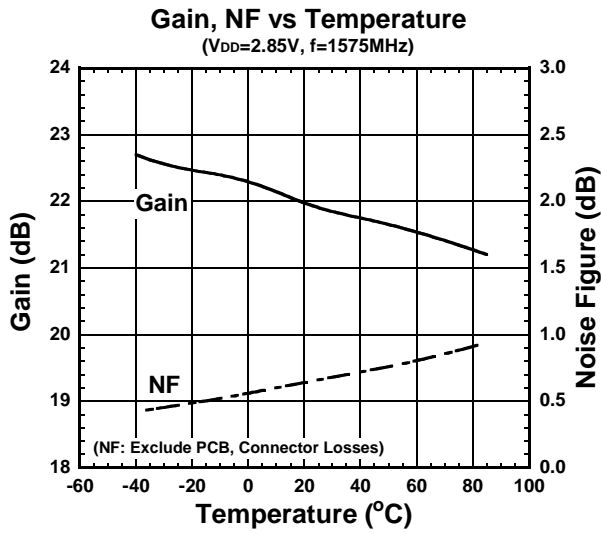

## ■ ELECTRICAL CHARACTERISTICS ( $V_{DD}=1.8V$ )

(Conditions:  $T_a=+25^{\circ}C$ ,  $V_{DD}=1.8V$ ,  $Z_s=Z_l=50\ \text{ohm}$ , with application circuit.)

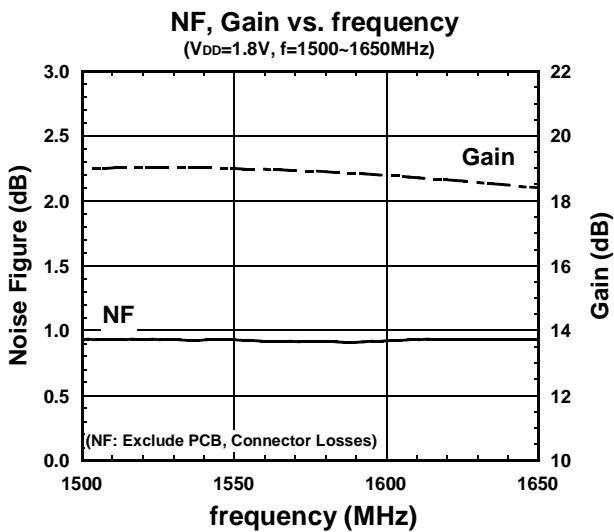
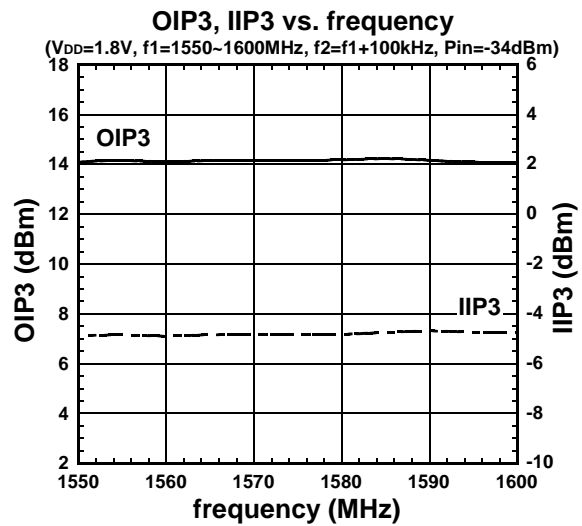
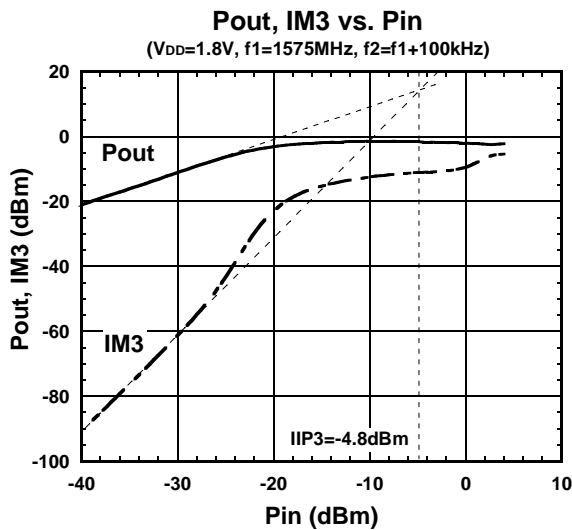
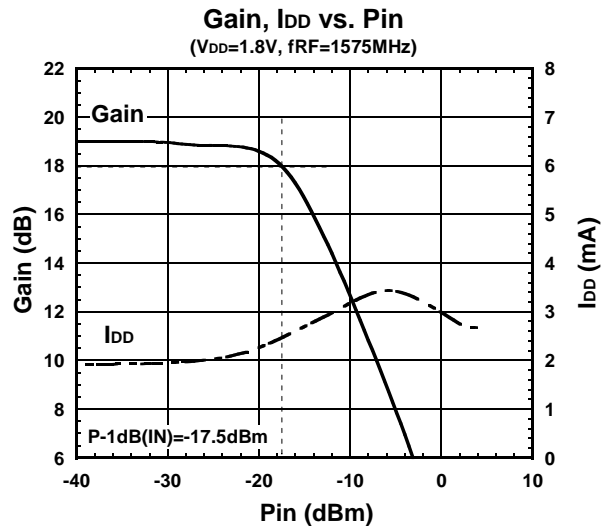
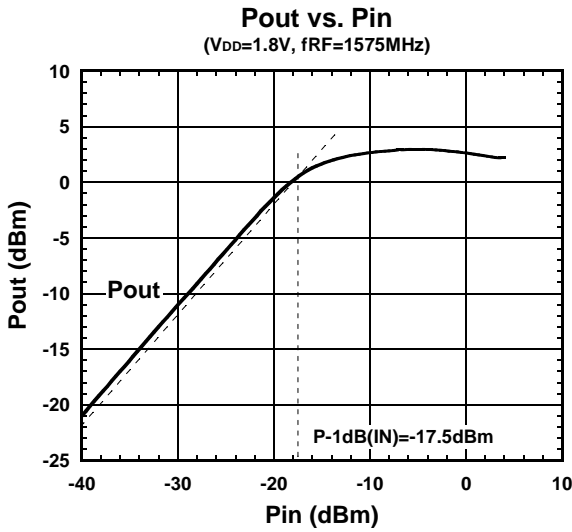

## ■ ELECTRICAL CHARACTERISTICS ( $V_{DD}=1.8V$ )

(Conditions:  $V_{DD}=1.8V$ ,  $Z_S=Z_L=50\ \Omega$ , with application circuit.)

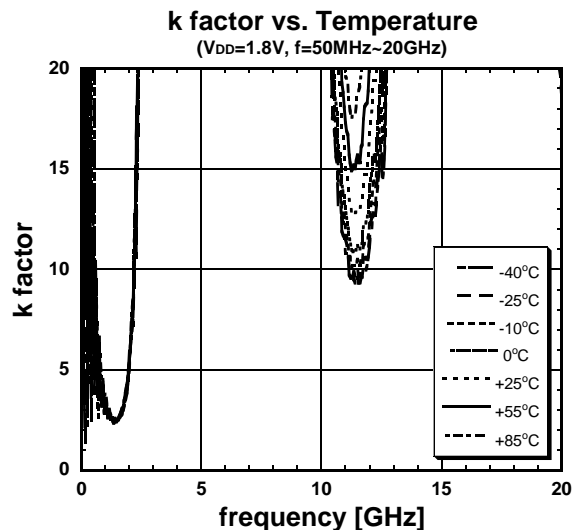
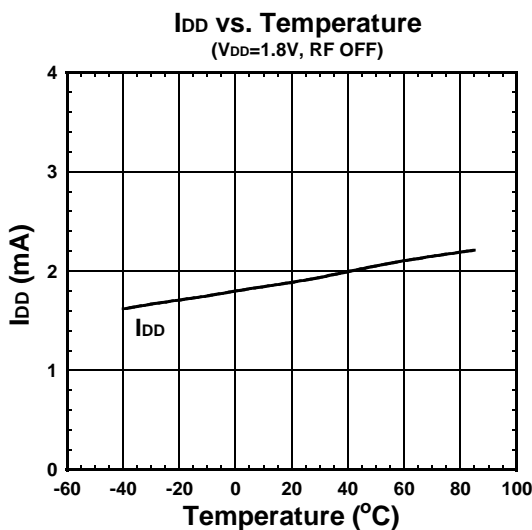
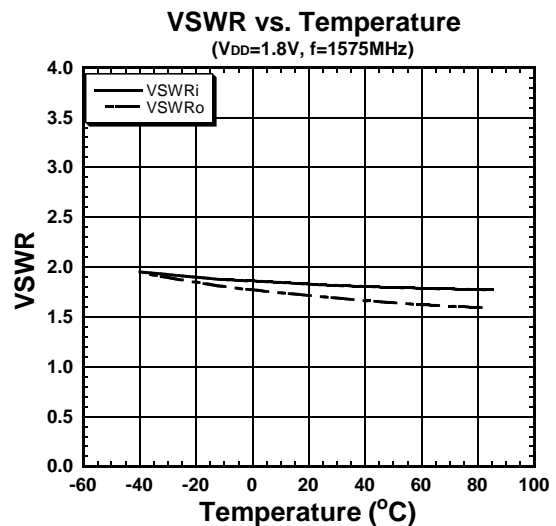
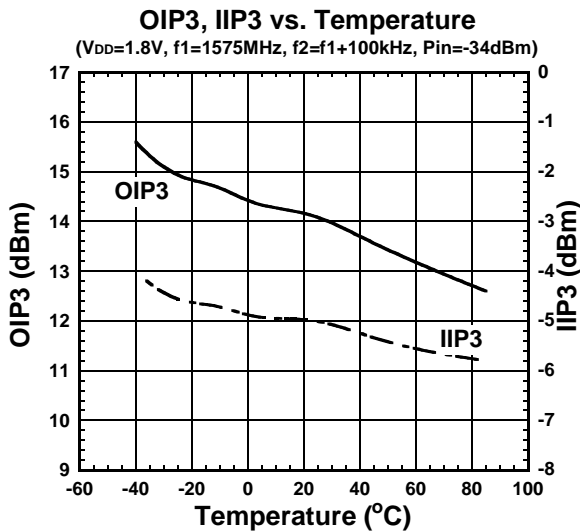
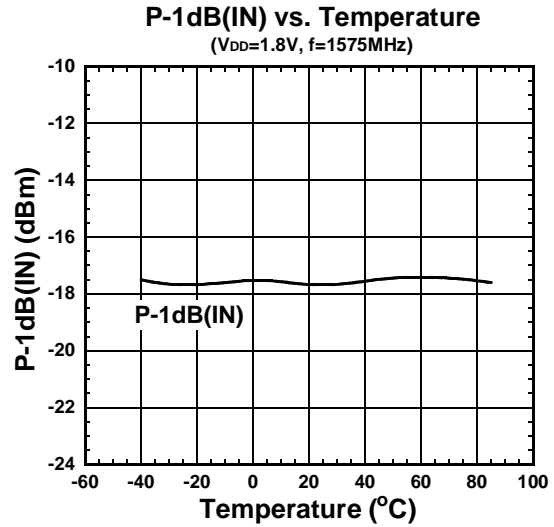
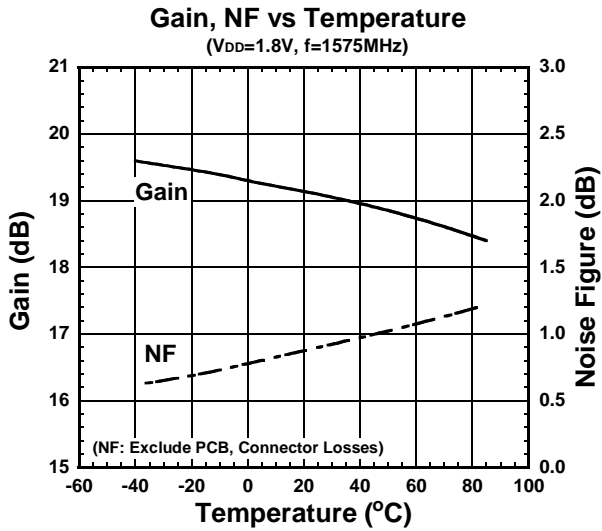



## ■ ELECTRICAL CHARACTERISTICS

(Conditions:  $T_a=+25^{\circ}\text{C}$ ,  $Z_s=Z_l=50\ \text{ohm}$ , with application circuit.)

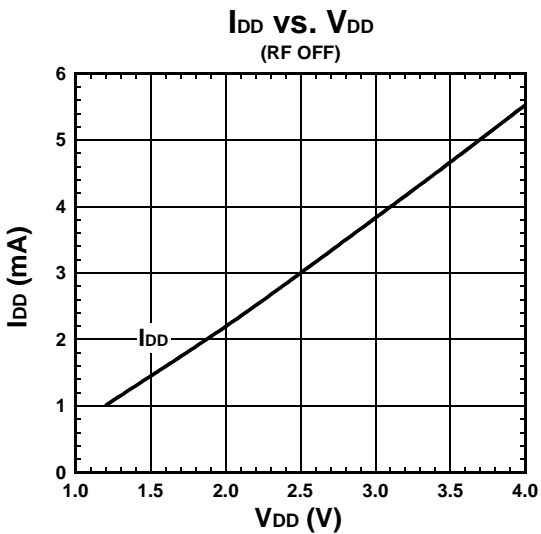
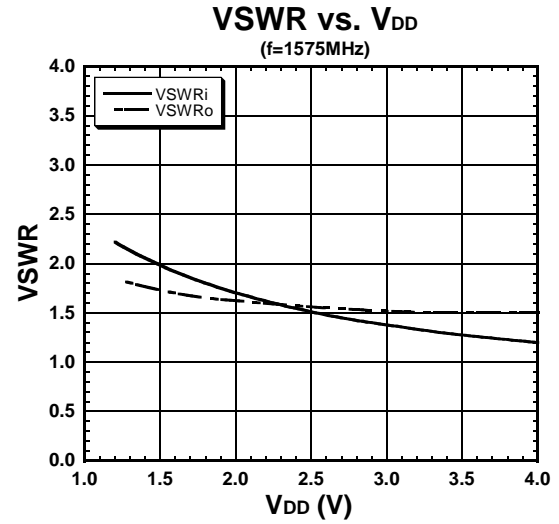
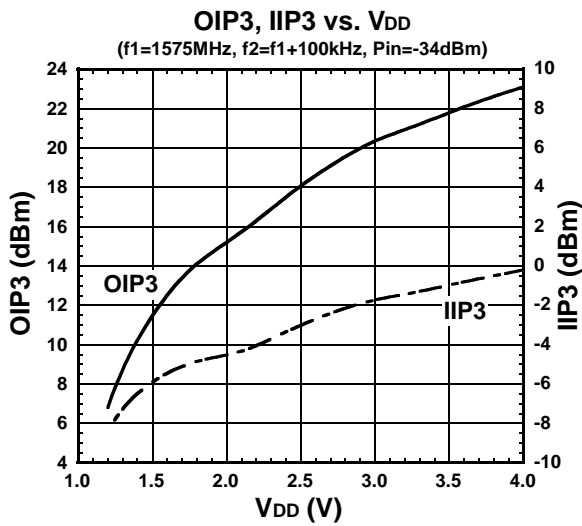
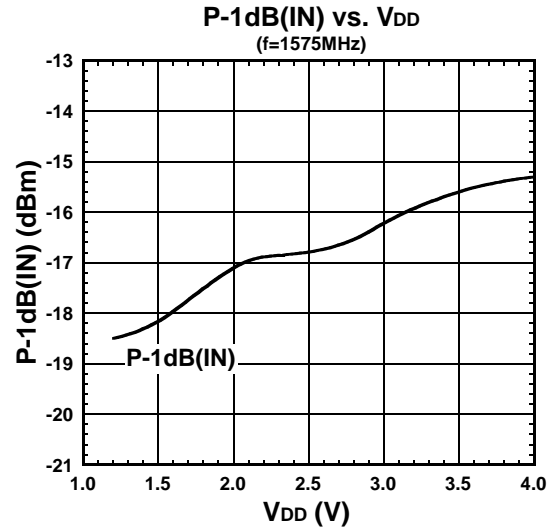
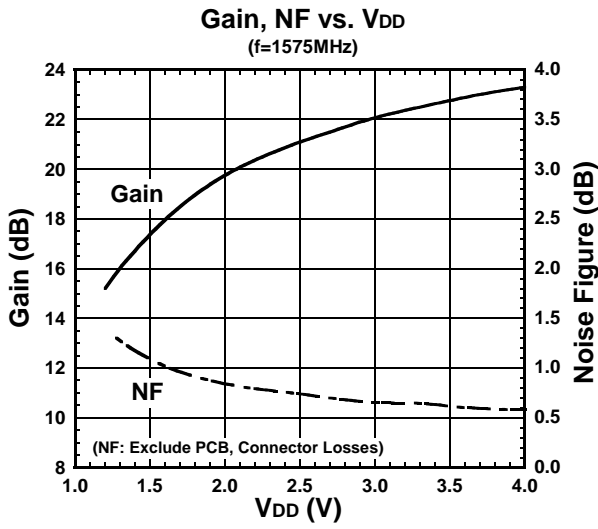

## ■ ELECTRICAL CHARACTERISTICS ( $V_{DD}=2.85V$ )

(Conditions:  $T_a=+25^{\circ}C$ ,  $V_{DD}=2.85V$ ,  $Z_s=Z_l=50\ \Omega$ , with application circuit.)

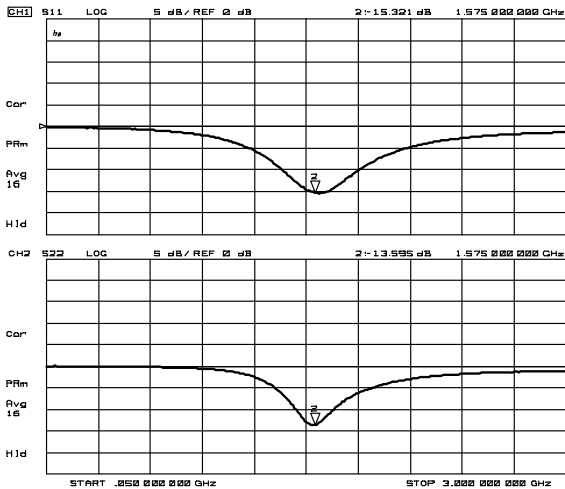

VSWR

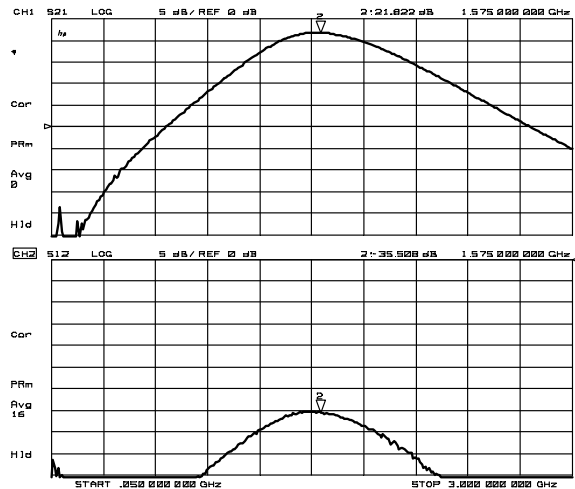

S21, S12

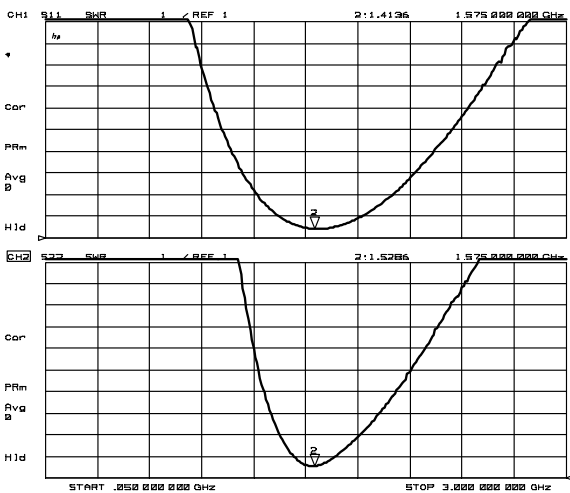

S11, S22

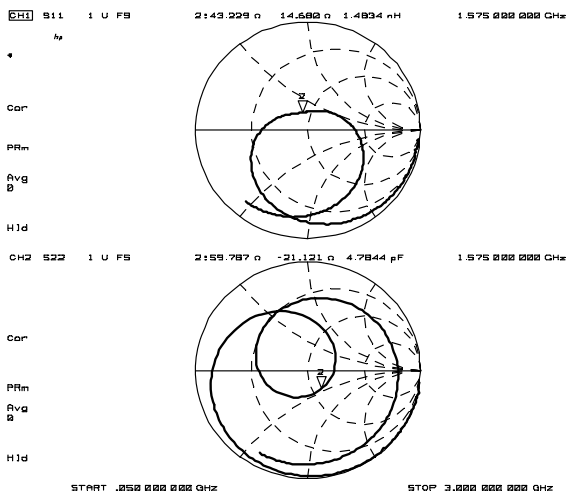

Zin, Zout

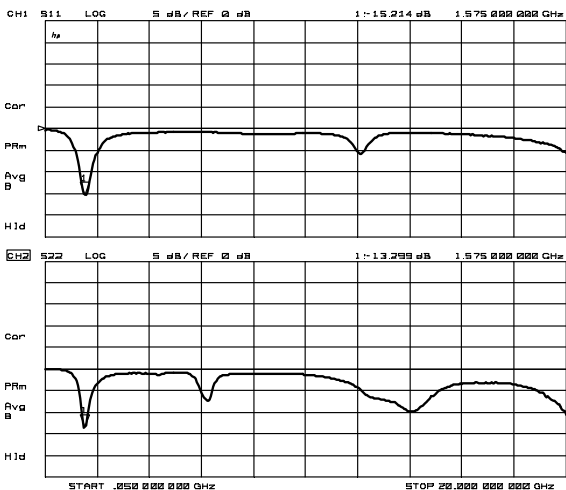

S11, S22 (~20GHz)

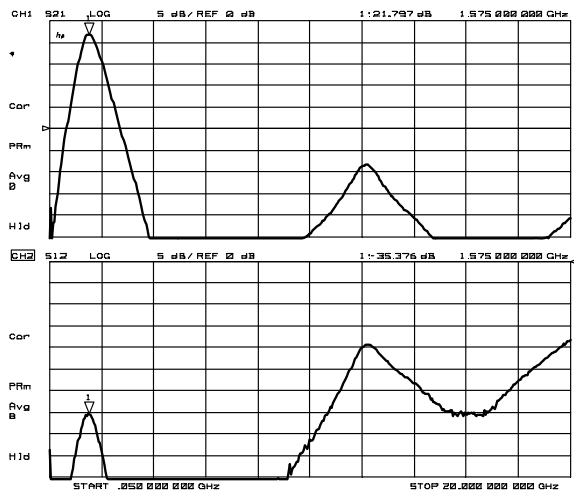

S21, S12 (~20GHz)

## ■ ELECTRICAL CHARACTERISTICS ( $V_{DD}=1.8V$ )

(Conditions:  $T_a=+25^{\circ}C$ ,  $V_{DD}=1.8V$ ,  $Z_s=Z_l=50\ \Omega$ , with application circuit.)

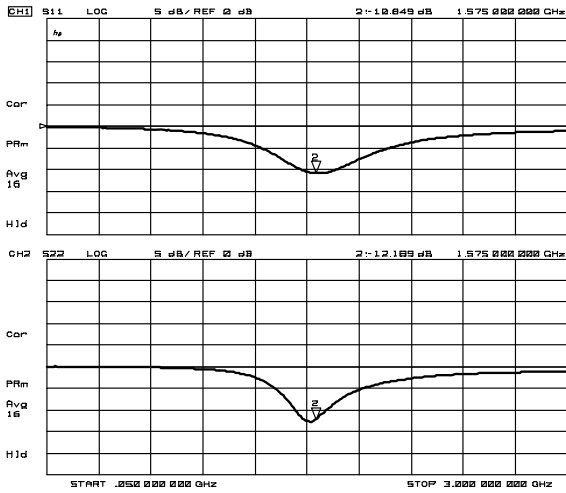

VSWR

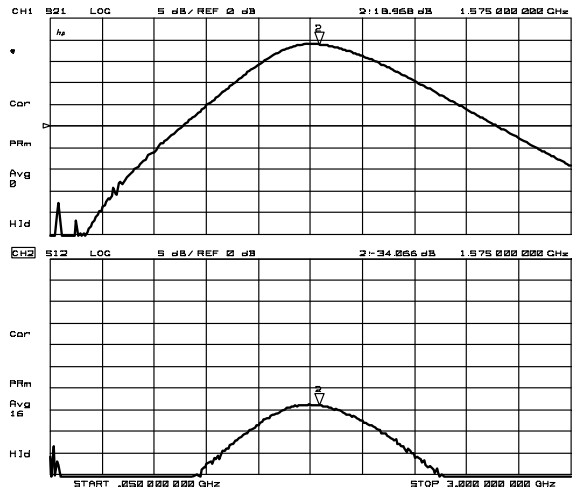

S21, S12

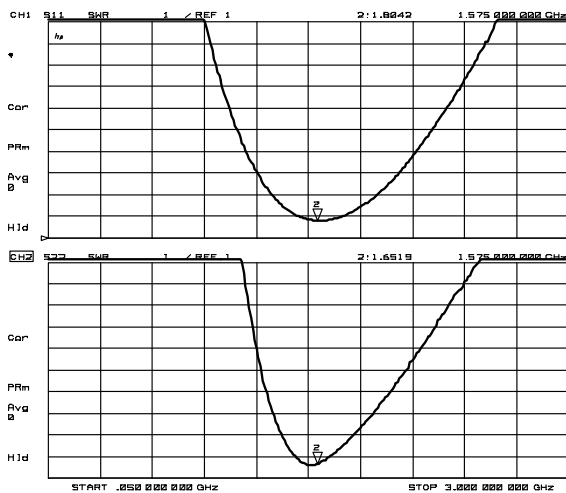

S11, S22

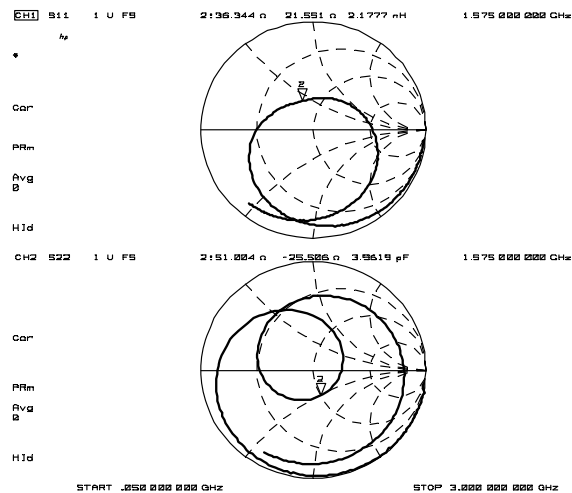

Zin, Zout

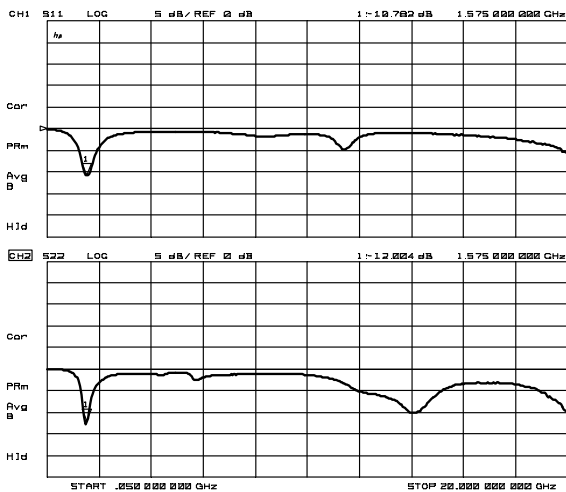

S11, S22 (~20GHz)

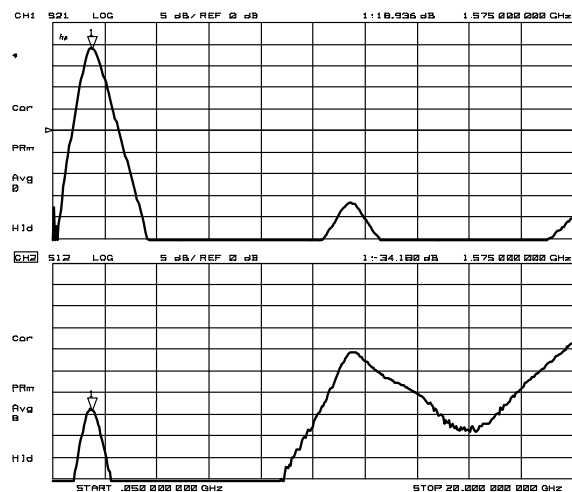

S21, S12 (~20GHz)

## APPLICATION CIRCUIT

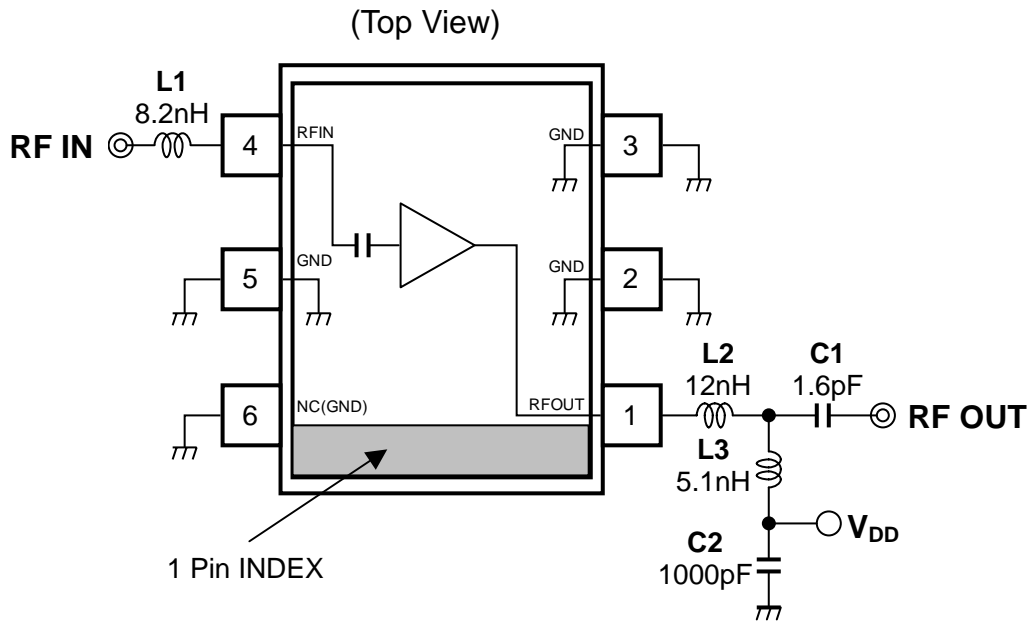

## TEST PCB LAYOUT

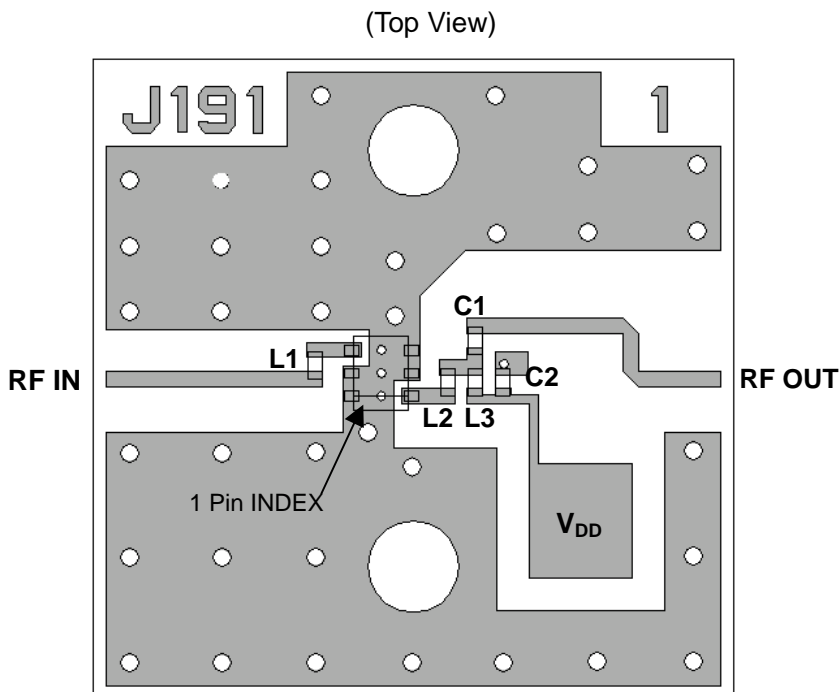

### Parts list:

Parts ID	Comments
L1~L3	MURATA LQP03T_02 Series
C1, C2	MURATA GRM03 Series

PCB (FR-4):  
 $t=0.2\text{mm}$   
 MICROSTRIP LINE WIDTH  
 $=0.34\text{mm}$  ( $Z_0=50\Omega$ )  
 PCB SIZE= $14.0\text{mm} \times 14.0\text{mm}$

### Caution:

In order not to couple with terminal RFIN and RFOUT, please layout ground pattern under the IC.

## MEASUREMENT BLOCK DIAGRAM

- S parameter Measurements

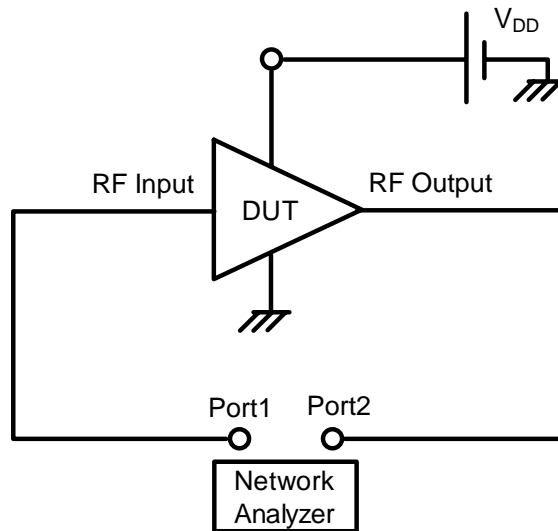

S parameter Measurement Block Diagram

- IIP3 Measurements

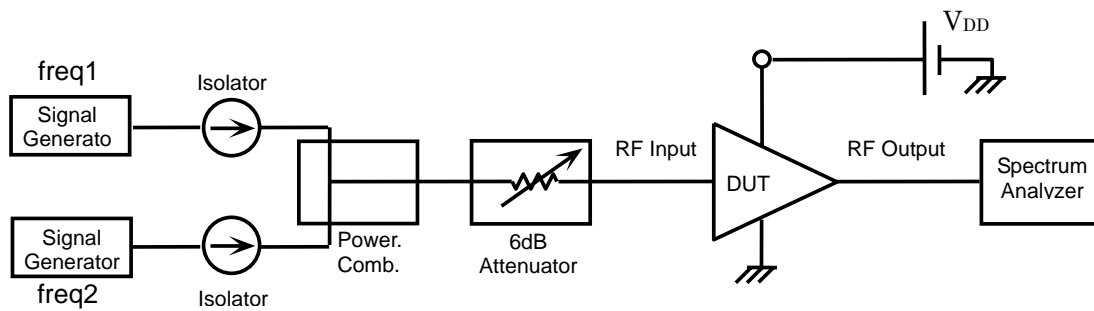

IF and IM3 Measurement Block Diagram for IIP3

## ● Noise Figure Measurements

### Measuring instruments

NF Analyzer : Agilent 8973A, 8975A  
 Noise Source : Agilent 346A

### Setting the NF analyzer

Measurement mode form

Device under test : Amplifier  
 System downconverter : off

Mode setup form

Sideband : LSB  
 Averages : 16  
 Average mode : Point  
 Bandwidth : 4MHz  
 Loss comp : off  
 Tcold : setting the temperature of noise source (303.15K)

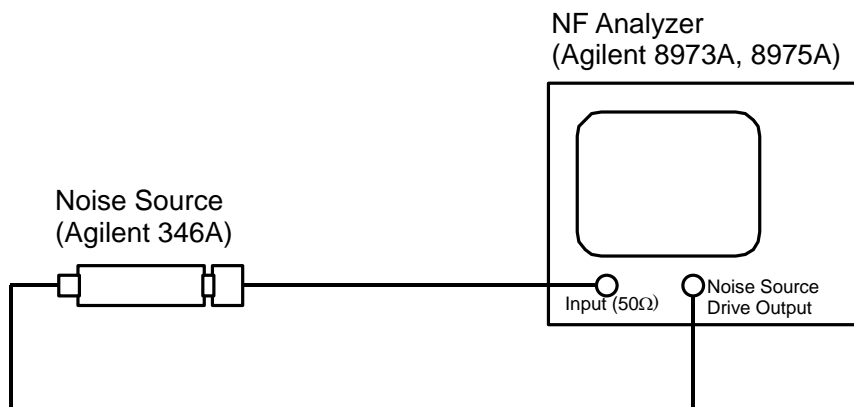

\* Noise source and NF analyzer are connected directly.

**Calibration Setup**

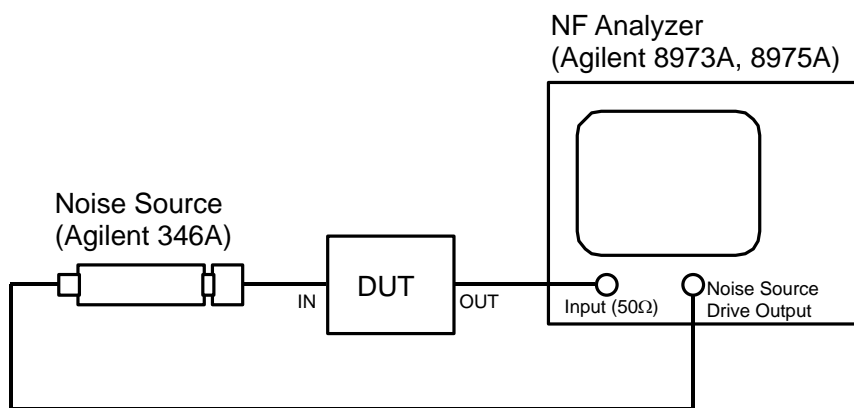

\* Noise source and DUT, DUT and NF analyzer are connected directly.

**Measurement Setup**

## ■ PACKAGE OUTLINE (FLP6-A1)

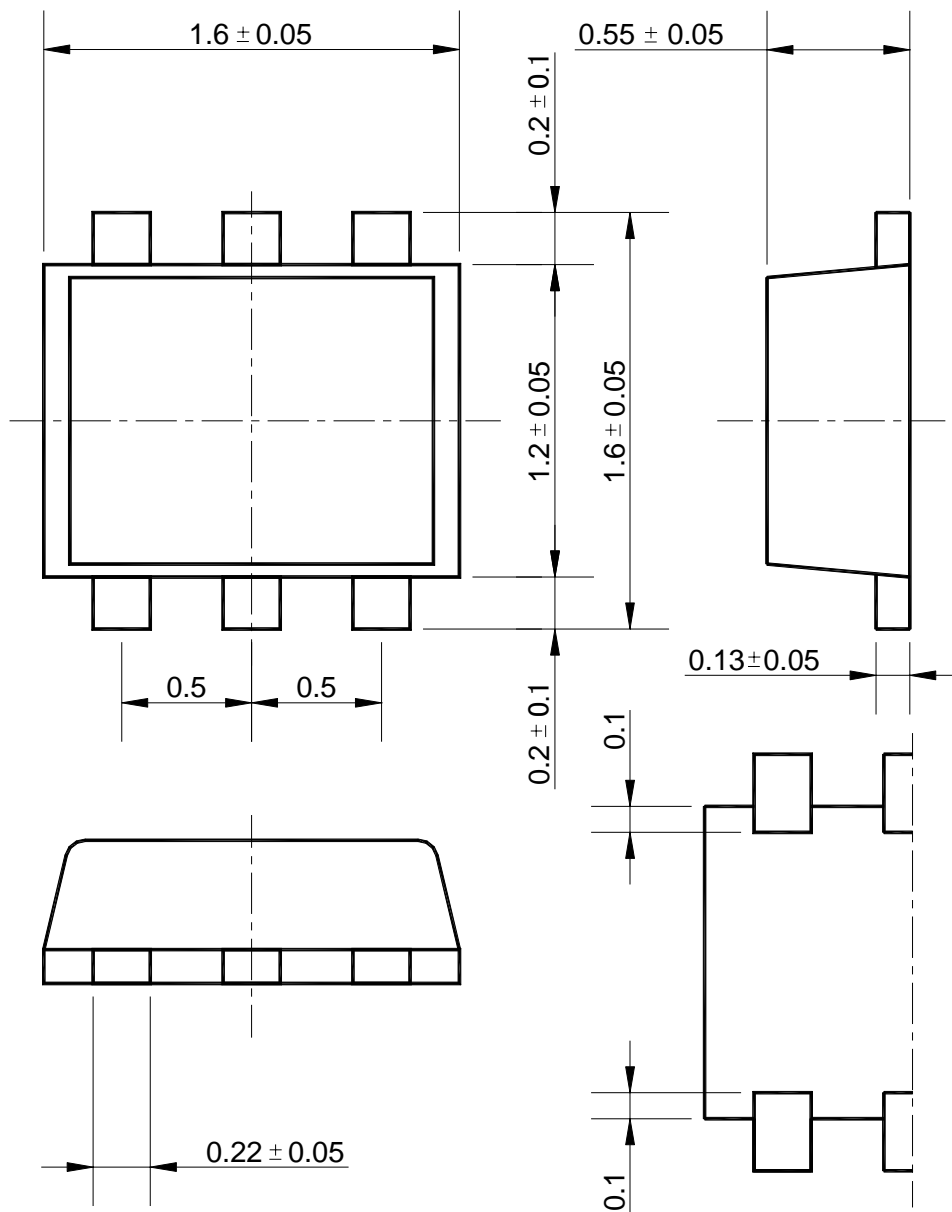

Unit : mm

### Cautions on using this product

- This product contains Gallium-Arsenide (GaAs) which is a harmful material.
- Do NOT eat or put into mouth.
  - Do NOT dispose in fire or break up this product.
  - Do NOT chemically make gas or powder with this product.
  - To waste this product, please obey the relating law of your country.

This product may be damaged with electric static discharge (ESD) or spike voltage. Please handle with care to avoid these damages.

### [CAUTION]

The specifications on this databook are only given for information, without any guarantee as regards either mistakes or omissions. The application circuits in this databook are described only to show representative usages of the product and not intended for the guarantee or permission of any right including the industrial rights.