

## WIDE BAND LOW NOISE AMPLIFIER GaAs MMIC

### ■ GENERAL DESCRIPTION

The NJG1146KG1 is a fully matched wide band low noise amplifier GaAs MMIC for digital TV applications.

To achieve wide dynamic range, the NJG1146KG1 offers high gain mode and low gain mode. Selecting high gain mode for weak signals, the NJG1146KG1 helps improve receiver sensitivity through high gain and low noise figure. Selecting low gain mode for strong signals, it bypasses LNA circuit to offer higher linearity.

An small and ultra-thin package of ESON6-G1 is adopted.

### ■ PACKAGE OUTLINE



NJG1146KG1

### ■ FEATURES

- Operating frequency                    40MHz~900MHz
- Operating voltage                        5.0V typ.
- Package size                                ESON6-G1 (Package size: 1.6mm x 1.6mm x 0.397mm typ.)

[High gain mode]

- Operating current                        60mA typ.
- Gain    12.0dB typ.
- Noise figure                                2.2dB typ.
- IM2    52.0dB typ.
- IM3    80.0dB typ.

[Low gain mode]

- Low current consumption                30μA typ.
- Gain(Low loss)                            -1.0dB typ.

### ■ PIN CONFIGURATION

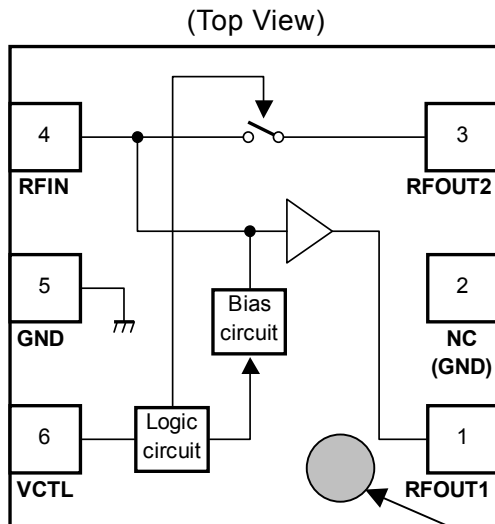

Pin Connection

1. RFOUT1
  2. NC(GND)
  3. RFOUT2
  4. RFIN
  5. GND
  6. VCTL
- \*Exposed PAD: GND

1pin INDEX

### ■ TRUTH TABLE      "H"= $V_{CTL(H)}$ "L"= $V_{CTL(L)}$

$V_{CTL}$	LNA ON	Bypass	LNA mode
H	ON	OFF	High Gain mode
L	OFF	ON	Low Gain mode

Note: Specifications and description listed in this datasheet are subject to change without notice.

# NJG1146KG1

## ■ ABSOLUTE MAXIMUM RATINGS

$T_a=+25^{\circ}\text{C}$ ,  $Z_s=Z_i=50\ \text{ohm}$

PARAMETER	SYMBOL	CONDITIONS	RATINGS	UNITS
Drain voltage	$V_{DD}$		6.0	V
Control voltage	$V_{CTL}$		6.0	V
Input power	$P_{IN}$	$V_{DD}=5.0\text{V}$	+10	dBm
Power dissipation	$P_D$	4-layer FR4 PCB with through-hole (101.5x114.5mm), $T_j=150^{\circ}\text{C}$	1200	mW
Operating temperature	$T_{opr}$		-40~+85	$^{\circ}\text{C}$
Storage temperature	$T_{stg}$		-55~+150	$^{\circ}\text{C}$

## ■ ELECTRICAL CHARACTERISTICS1 (DC CHARACTERISTICS)

$V_{DD}=5.0\text{V}$ ,  $T_a=+25^{\circ}\text{C}$ , with application circuit

PARAMETERS	SYMBOL	CONDITIONS	MIN	TYP	MAX	UNITS
Operating voltage	$V_{DD}$		2.4	5.0	5.5	V
Control voltage (High)	$V_{CTL(H)}$		1.3	1.8	5.5	V
Control voltage (Low)	$V_{CTL(L)}$		0.0	0.0	0.5	V
Operating current1	$I_{DD1}$	RF OFF, $V_{CTL}=1.8\text{V}$	-	60	80	mA
Operating current2	$I_{DD2}$	RF OFF, $V_{CTL}=0\text{V}$	-	30	50	$\mu\text{A}$
Control current	$I_{CTL}$	RF OFF, $V_{CTL}=1.8\text{V}$	-	6	12	$\mu\text{A}$

## ■ ELECTRICAL CHARACTERISTICS2 (High Gain mode)

$V_{DD}=5.0V$ ,  $V_{CTL}=1.8V$ , freq=40~900MHz,  $T_a=+25^{\circ}C$ ,  $Z_S=Z_I=50\text{ ohm}$ , with application circuit

PARAMETERS	SYMBOL	CONDITIONS	MIN	TYP	MAX	UNITS
Small signal gain1	Gain1	Exclude PCB & connector losses *1	9.0	12.0	14.0	dB
Noise figure1_1	NF1_1	freq=40~80MHz, Exclude PCB & connector losses *2	-	2.5	4.0	dB
Noise figure1_2	NF1_2	freq=80~900MHz, Exclude PCB & connector losses *2	-	2.2	3.0	dB
Input power at 1dB gain compression point1	P-1dB(IN)1		+0.0	+6.0	-	dBm
Input 3rd order intercept point1	IIP3_1	f1=freq, f2=freq+100kHz, $P_{IN}=-12\text{dBm}$	+16.0	+22.0	-	dBm
2nd order intermodulation distortion1	IM2_1	f1=200MHz, f2=500MHz, fmeas=700MHz, $P_{IN1}=P_{IN2}=-15\text{dBm}$ *3	42.0	52.0	-	dB
3rd order intermodulation distortion1	IM3_1	f1=600MHz, f2=650MHz, fmeas=700MHz, $P_{IN1}=P_{IN2}=-15\text{dBm}$ *3	55.0	80.0	-	dB
Isolation	ISL1	S12	-	-17.0	-13.0	dB
RF IN Return loss1	RLi1		7.0	10.0	-	dB
RF OUT Return loss1	RLo1		7.0	10.0	-	dB

\*1 Input & output PCB and connector losses: 0.014dB(40MHz), 0.088dB(620MHz), 0.121dB(900MHz)

\*2 Input PCB and connector losses: 0.007dB(40MHz), 0.011dB(80MHz), 0.044dB(620MHz), 0.060dB(900MHz)

\*3 Definitions of IM2 and IM3.

**Pout(dBm)**

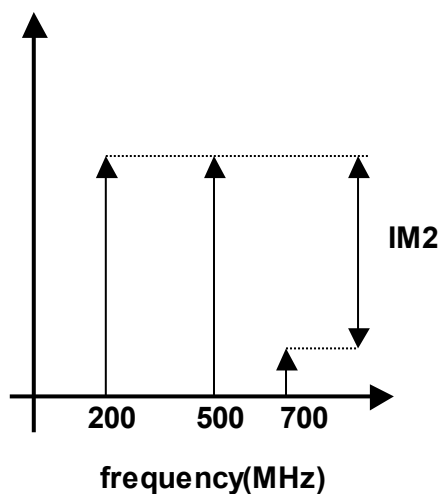

**Pout(dBm)**

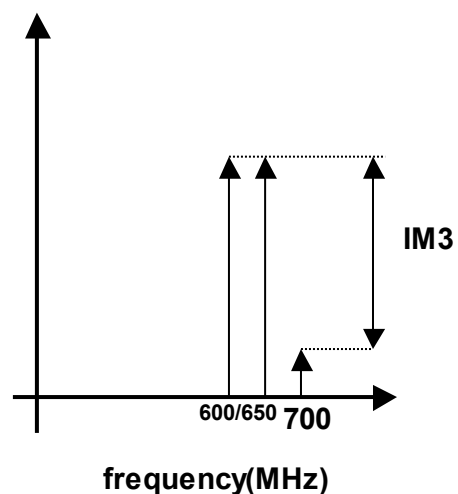

# NJG1146KG1

## ■ ELECTRICAL CHARACTERISTICS3 (High Gain mode)

$V_{DD}=5.0V$ ,  $V_{CTL}=1.8V$ , freq=40~900MHz,  $T_a=+25^{\circ}C$ ,  $Z_S=Z_L=75\text{ ohm}$ , with application circuit

PARAMETERS	SYMBOL	CONDITIONS	MIN	TYP	MAX	UNITS
Small signal gain75	Gain75	Exclude PCB & connector losses *1	-	12.0	-	dB
Composite Second Order	CSO	74channels *4, CW $P_{IN}=+15dBmV$ fmeas=295.25MHz,	-	-56	-	dBc
Composite Triple Beat	CTB	74channels *4, CW $P_{IN}=+15dBmV$ fmeas=295.25±1.25MHz,	-	-81	-	dBc
Cross Modulation	XMOD	74channels *4, Modulation $P_{IN}=+15dBmV$ fmeas=295.25±15.75kHz,	-	-80	-	dBc
RF IN Return loss75	RLi75		-	15	-	dB
RF OUT Return loss75	RLo75		-	15	-	dB

\*1 Input & output PCB and connector losses: 0.014dB(40MHz), 0.088dB(620MHz), 0.121dB(900MHz)

\*4 74channels: ch1~C63(91.25~463.25MHz 6MHz step) and U13~U25(471.25~543.25MHz 6MHz step) except ch7(189.25MHz) , C28(253.25MHz)

## ■ ELECTRICAL CHARACTERISTICS4 (Low Gain mode)

$V_{DD}=5.0V$ ,  $V_{CTL}=0V$ ,  $freq=40\sim 900MHz$ ,  $T_a=+25^{\circ}C$ ,  $Z_S=Z_L=50\text{ ohm}$ , with application circuit

PARAMETERS	SYMBOL	CONDITIONS	MIN	TYP	MAX	UNITS
Small signal gain <sup>2</sup>	Gain <sub>2</sub>	Exclude PCB & connector losses *1	-2.5	-1.0	-	dB
Input power at 1dB gain compression point <sup>2</sup>	P-1dB(IN) <sub>2</sub>		+10.0	+16.0	-	dBm
Input 3rd order intercept point <sup>2</sup>	IIP3_2	f <sub>1</sub> =freq, f <sub>2</sub> =freq+100kHz, P <sub>IN</sub> =-2dBm	+25.0	+33.0	-	dBm
2nd order intermodulation distortion <sup>1</sup>	IM2_2	f <sub>1</sub> =200MHz, f <sub>2</sub> =500MHz, f <sub>meas</sub> =700MHz, P <sub>IN1</sub> =P <sub>IN2</sub> =0dBm *3	40.0	60.0	-	dB
3rd order intermodulation distortion <sup>1</sup>	IM3_2	f <sub>1</sub> =600MHz, f <sub>2</sub> =650MHz, f <sub>meas</sub> =700MHz, P <sub>IN1</sub> =P <sub>IN2</sub> =0dBm *3	48.0	70.0	-	dB
RF IN Return loss <sup>2</sup>	RLi <sub>2</sub>		8.0	15.0	-	dB
RF OUT Return loss <sup>2</sup>	RLo <sub>2</sub>		8.0	15.0	-	dB

\*1 Input & output PCB and connector losses: 0.014dB(40MHz), 0.088dB(620MHz), 0.121dB(900MHz)

\*3 Definitions of IM2 and IM3.

**Pout(dBm)**

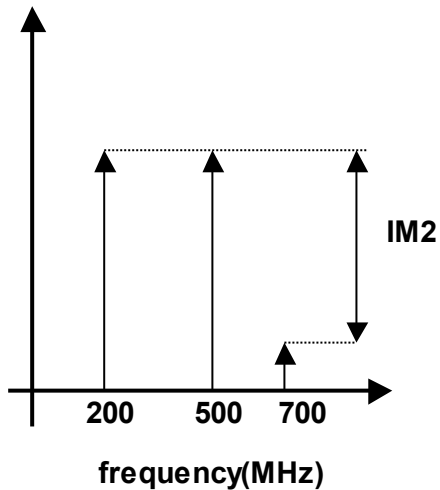

**Pout(dBm)**

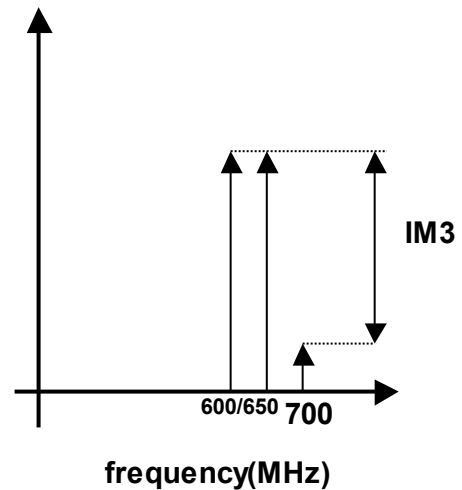

# NJG1146KG1

## ■ TERMINAL INFORMATION

No.	SYMBOL	DESCRIPTION
1	RFOUT1	At the High gain mode, RF output terminal. This terminal doubles as the drain terminal of the LNA. Please connect this terminal to the power supply(VDD) via inductor(L1).
2	NC(GND)	No connected terminal. This terminal is not connected with internal circuit.
3	RFOUT2	At the Low gain mode, RF output terminal. Please connect this terminal with RFOUT1 terminal through DC blocking capacitor(C2) shown in the application circuit.
4	RFIN	RF input terminal. External capacitor C1 is required to block the DC bias voltage of internal circuit.
5	GND	Ground terminal. This terminal should be connected to the ground plane as close as possible for excellent RF performance.
6	VCTL	Control voltage terminal.
Exposed Pad	GND	Ground terminal. Please connect Exposed Pad with GND by using the plated through holes.

**ELECTRICAL CHARACTERISTICS (High Gain mode)**

Conditions:  $V_{DD}=5.0V$ ,  $V_{CTL}=1.8V$ ,  $T_a=25^\circ C$ ,  $Z_s=Z_l=50\text{ ohm}$ , with application circuit

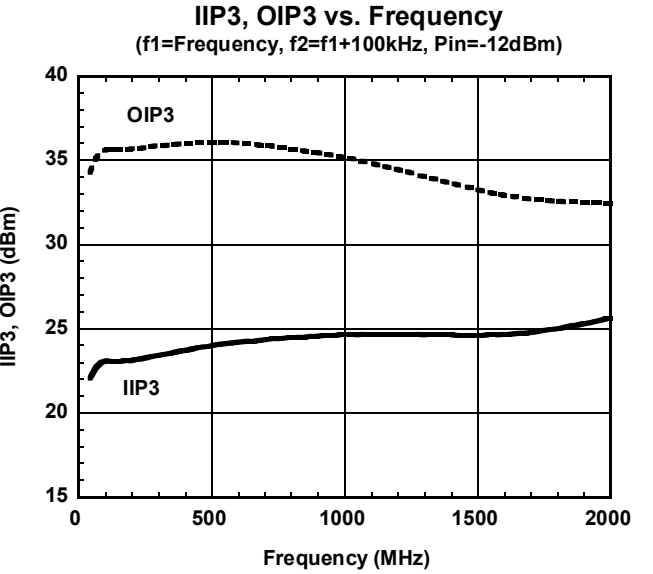
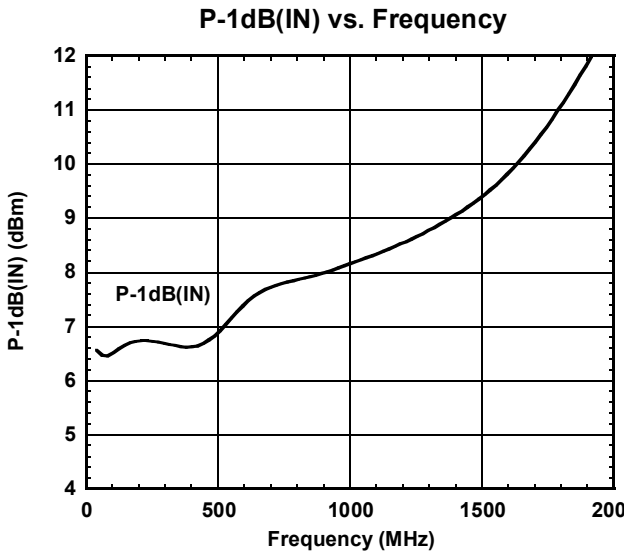
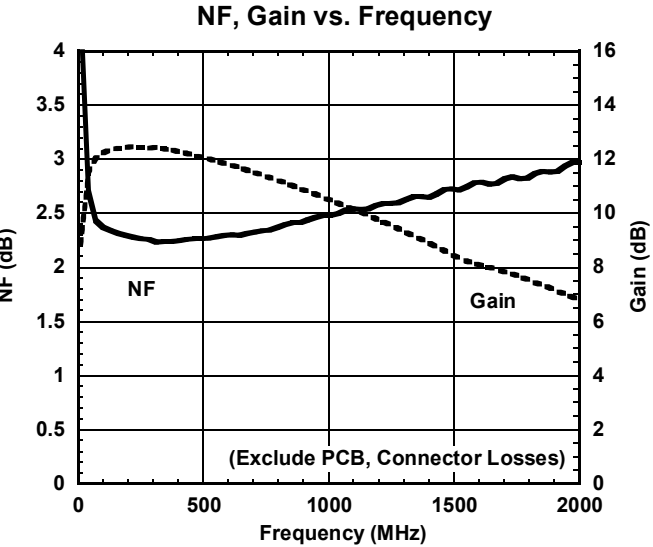
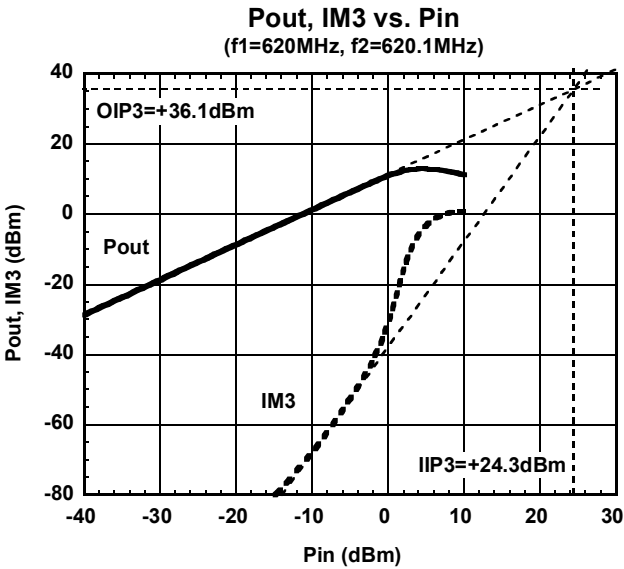
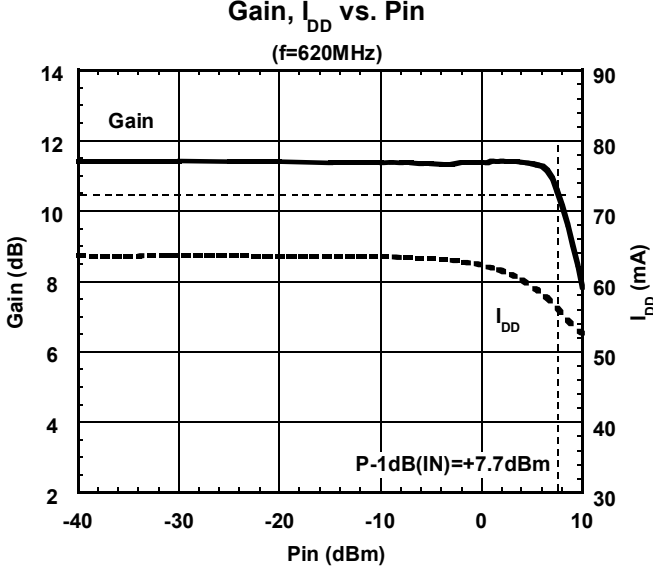
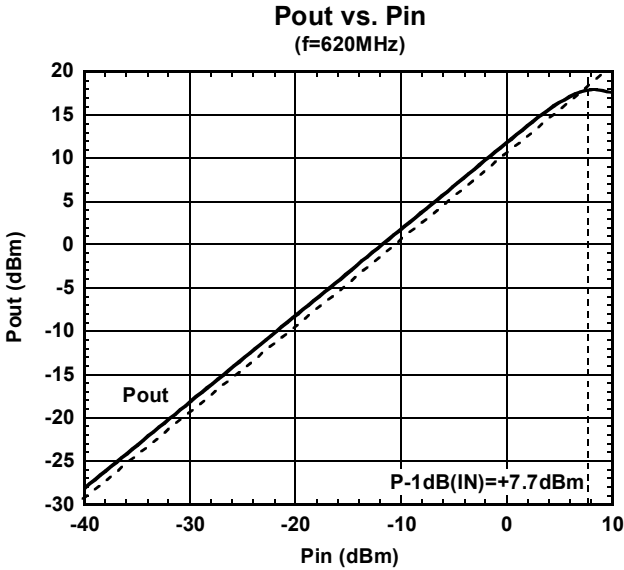

# NJG1146KG1

## ■ ELECTRICAL CHARACTERISTICS (High Gain mode)

Conditions:  $V_{DD}=5.0V$ ,  $V_{CTL}=1.8V$ ,  $T_a=25^\circ C$ ,  $Z_s=Z_l=50\ \text{ohm}$ , with application circuit

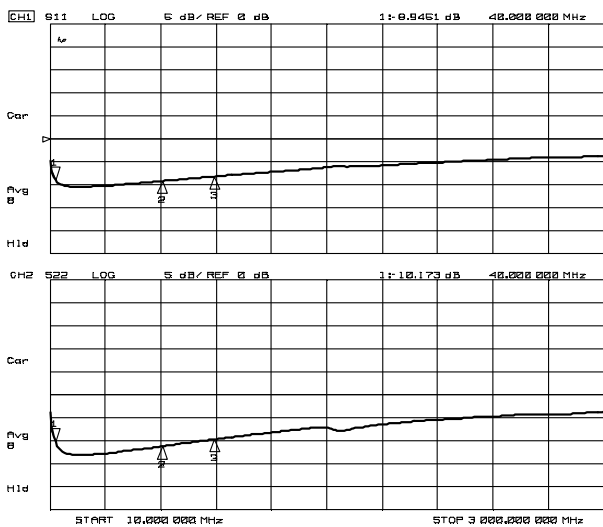

S11, S22 (f=10MHz~3GHz)

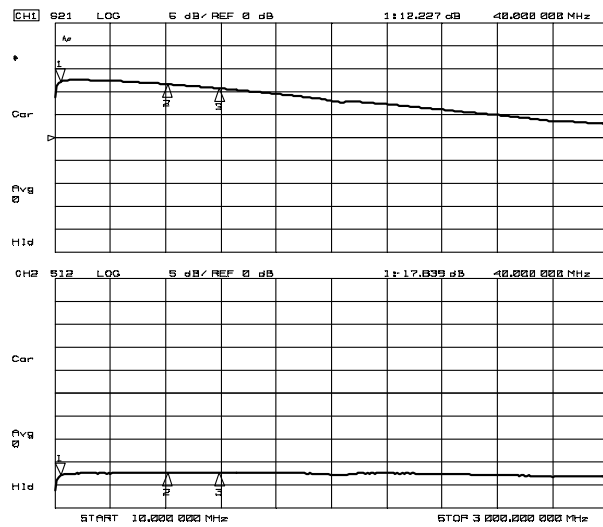

S21, S12 (f=10MHz~3GHz)

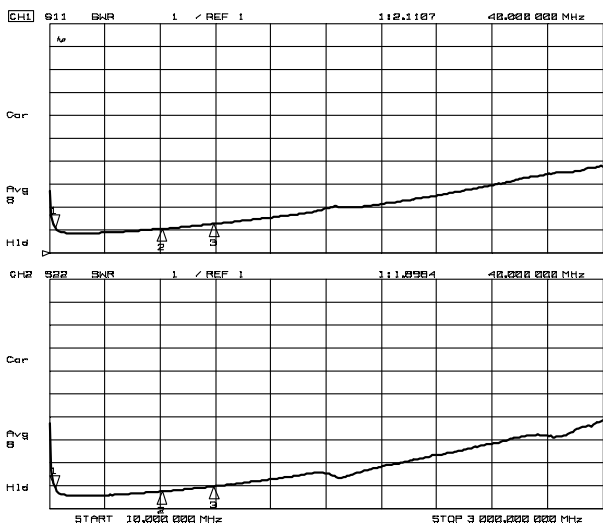

VSWR (f=10MHz~3GHz)

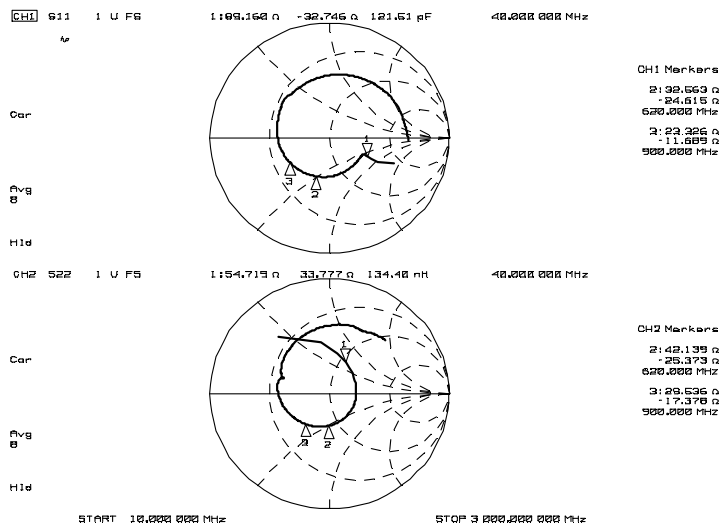

Zin, Zout (f=10MHz~3GHz)



**ELECTRICAL CHARACTERISTICS (High Gain mode)**

Conditions:  $V_{DD}=5.0V$ ,  $V_{CTL}=1.8V$ ,  $T_a=25^\circ C$ ,  $Z_s=Z_l=50\text{ ohm}$ , with application circuit

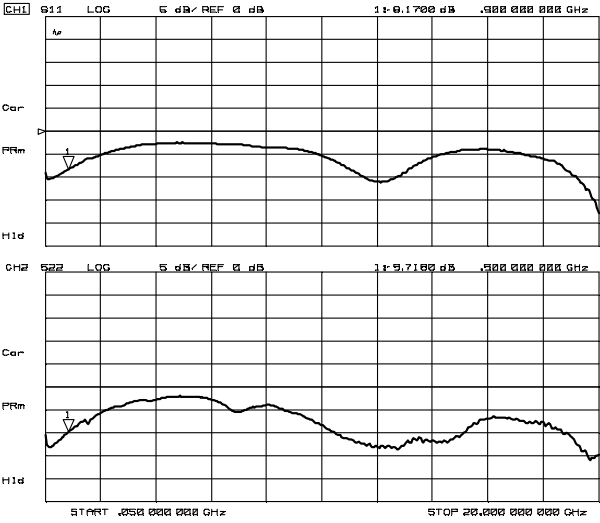

S11, S22 (f=50MHz~20GHz)

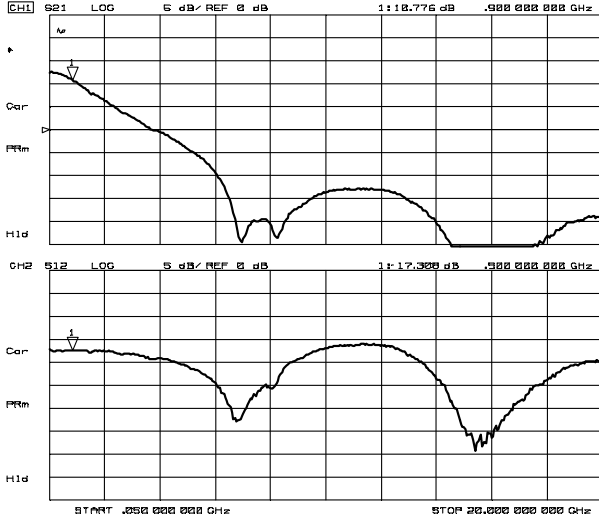

S21, S12 (f=50MHz~20GHz)

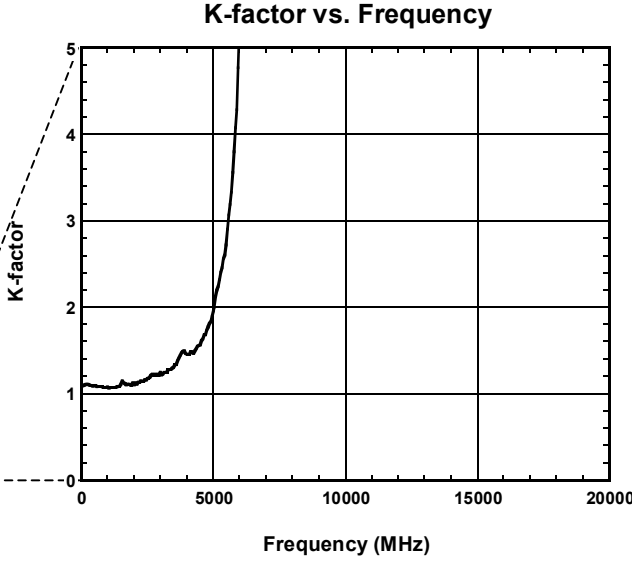
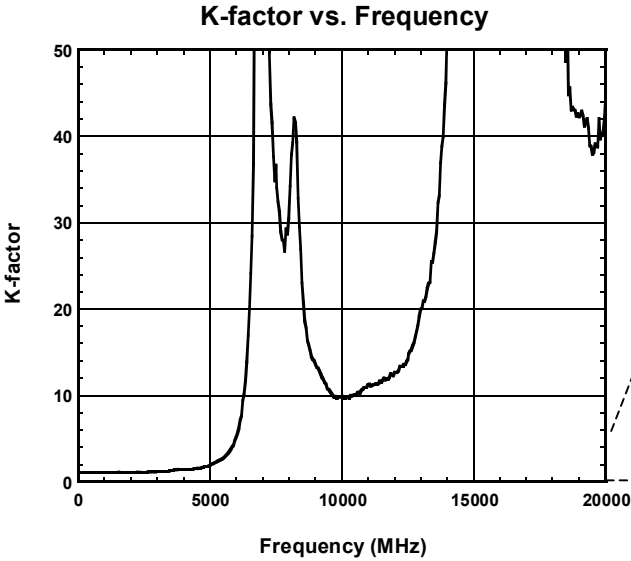

# NJG1146KG1

## ■ ELECTRICAL CHARACTERISTICS (High Gain mode)

Conditions:  $V_{CTL}=1.8V$ ,  $T_a=25^\circ C$ ,  $Z_s=Z_L=50\ \text{ohm}$ , with application circuit

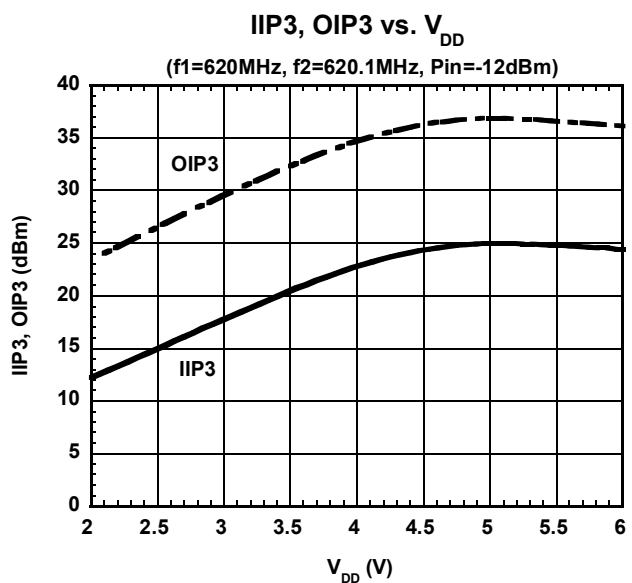
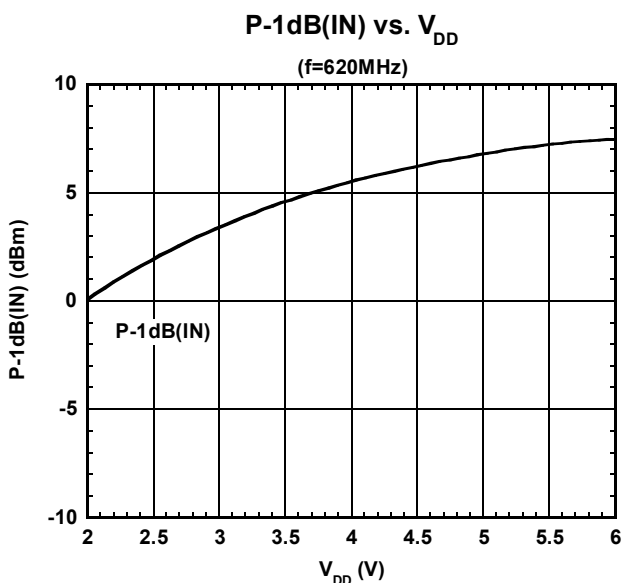
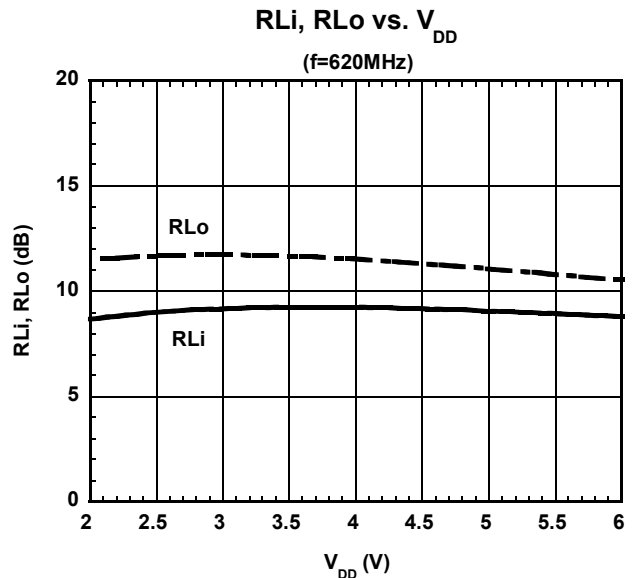
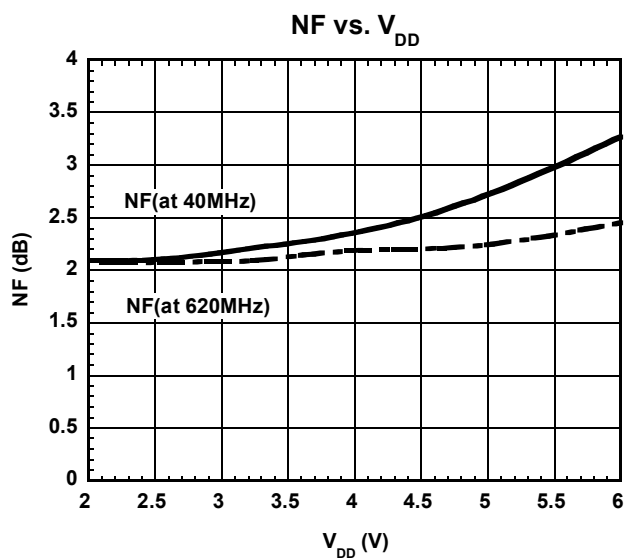
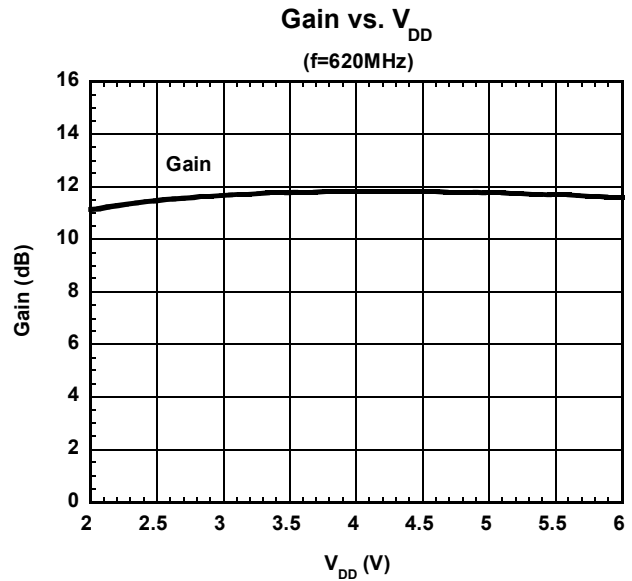
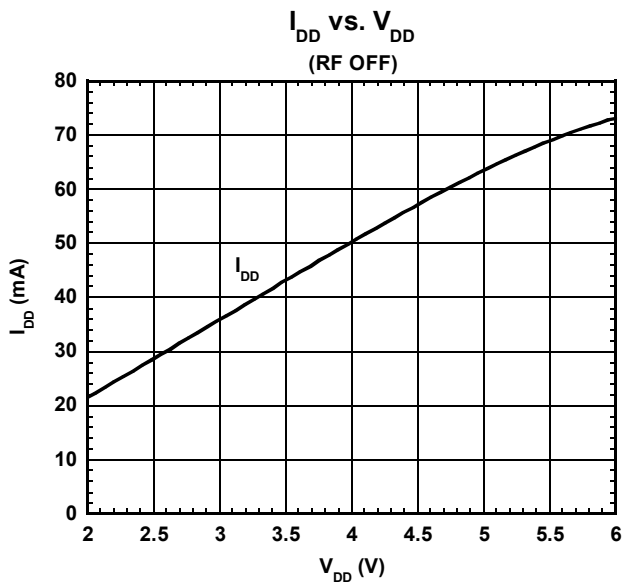

■ ELECTRICAL CHARACTERISTICS (High Gain mode)

Conditions:  $V_{CTL}=1.8V$ ,  $T_a=25^\circ C$ ,  $Z_s=Z_l=50\text{ ohm}$ , with application circuit

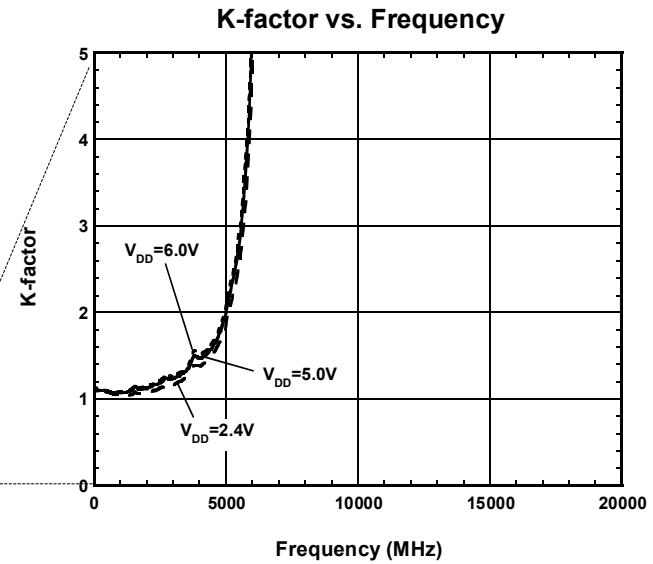
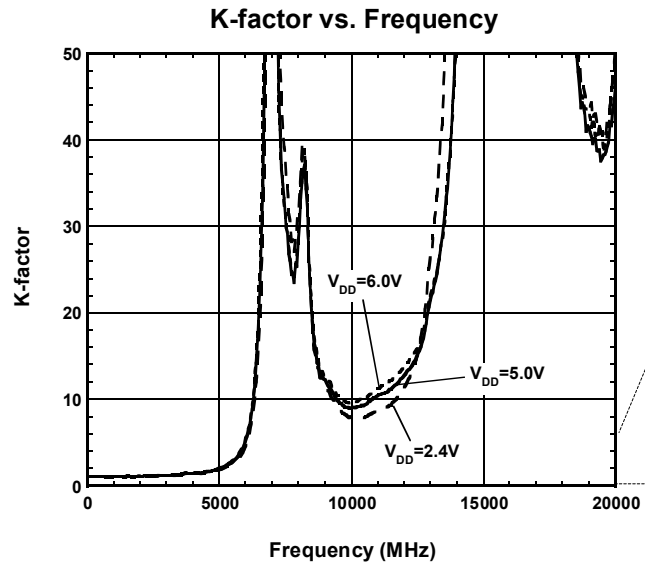
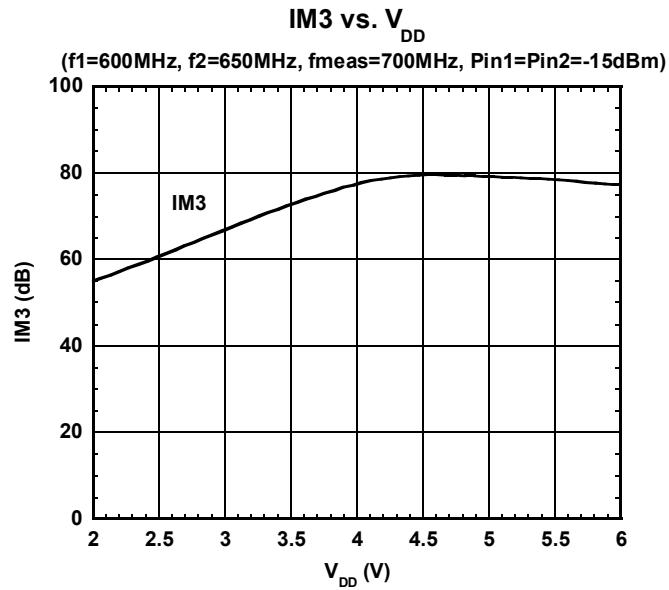
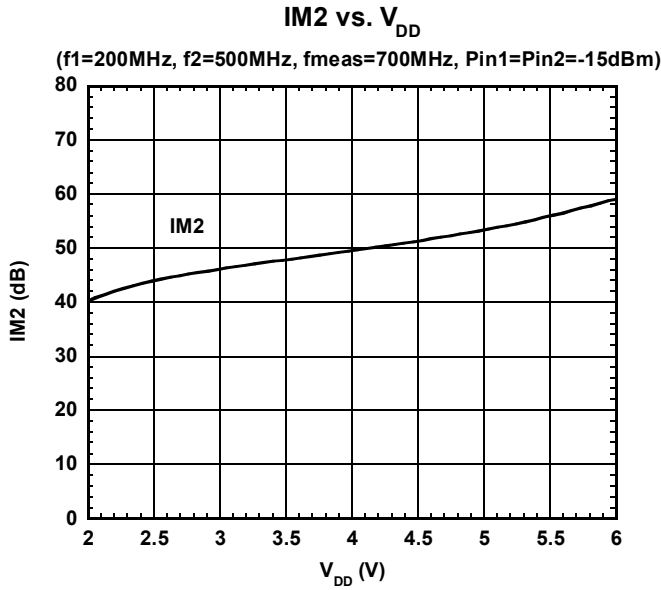

# NJG1146KG1

## ■ ELECTRICAL CHARACTERISTICS (High Gain mode)

Conditions:  $V_{DD}=5.0V$ ,  $V_{CTL}=1.8V$ ,  $Z_s=Z_l=50\text{ ohm}$ , with application circuit

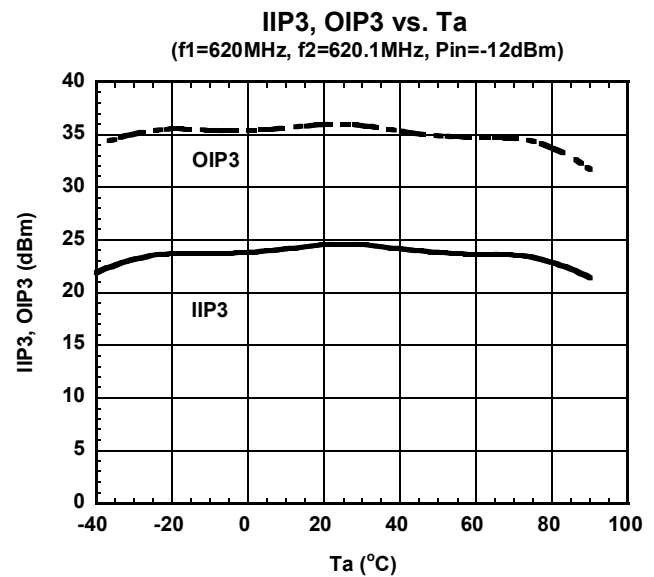
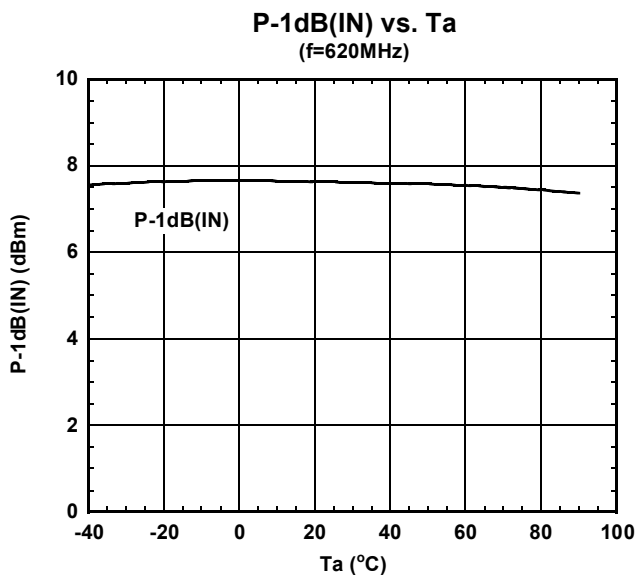
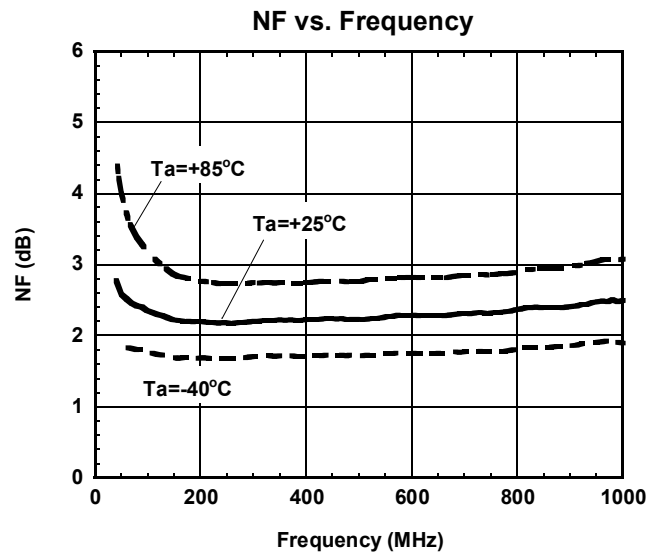
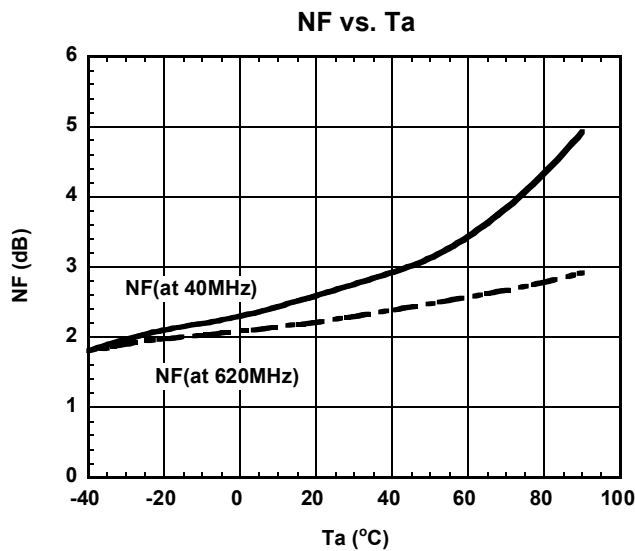
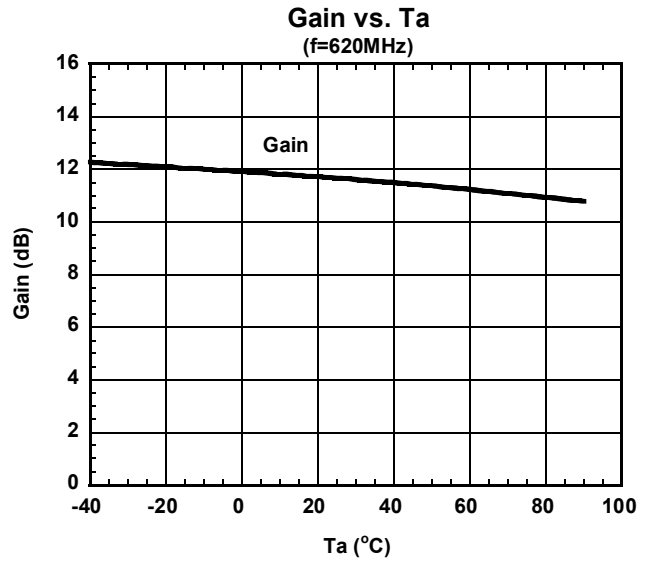
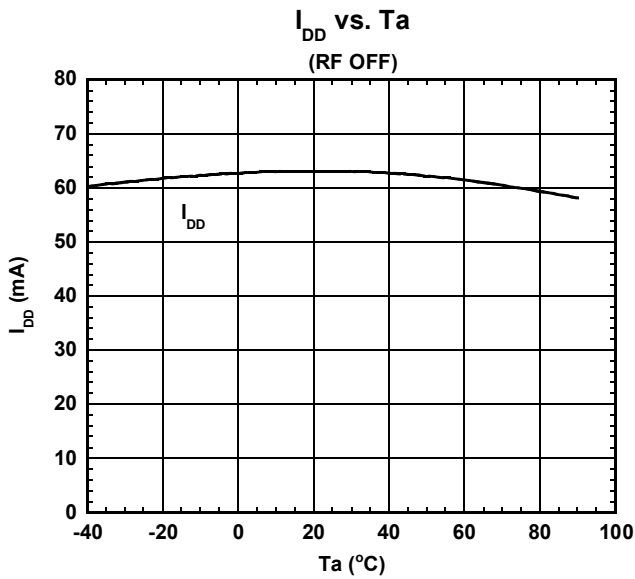

**■ ELECTRICAL CHARACTERISTICS (High Gain mode)**

Conditions:  $V_{DD}=5.0V$ ,  $V_{CTL}=1.8V$ ,  $Z_s=Z_l=50\text{ ohm}$ , with application circuit

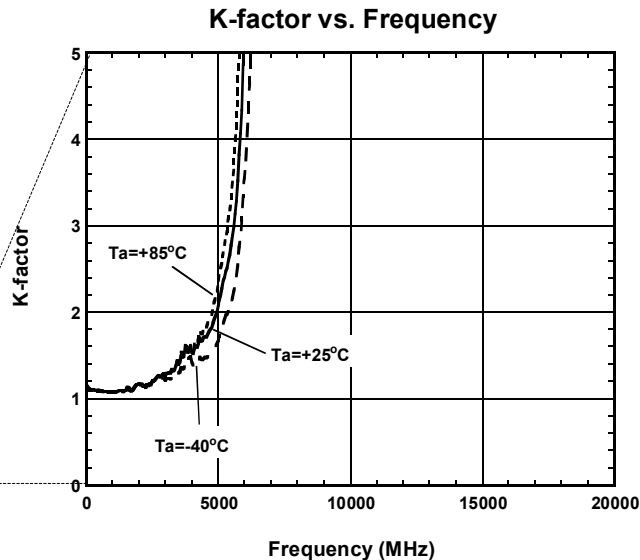
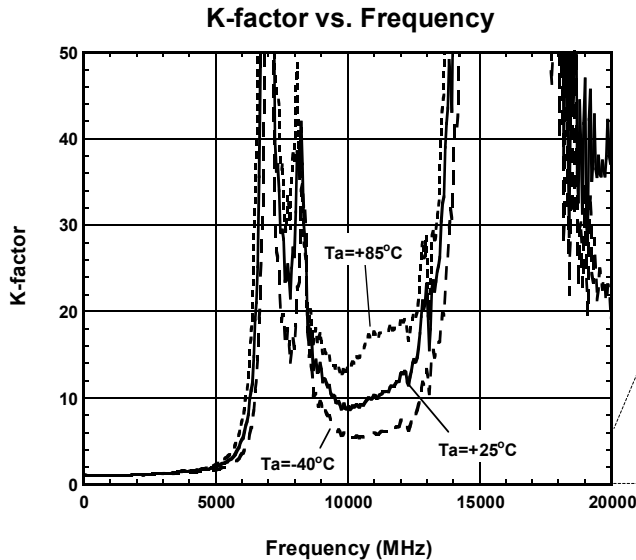
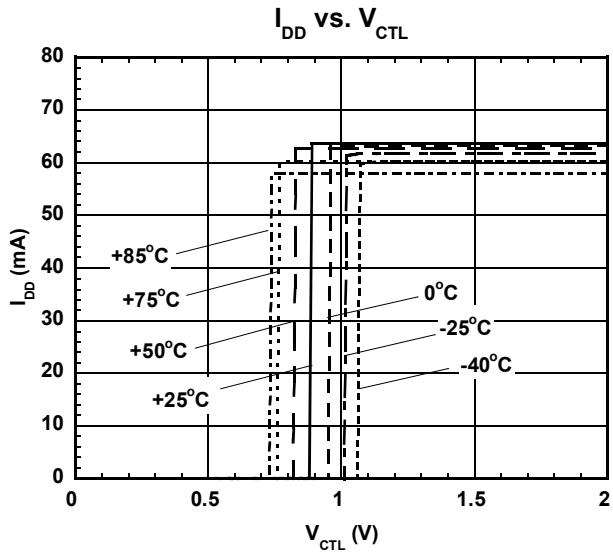
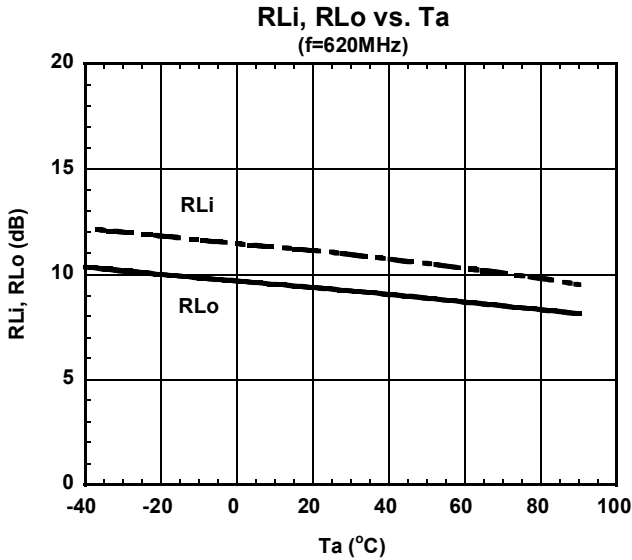
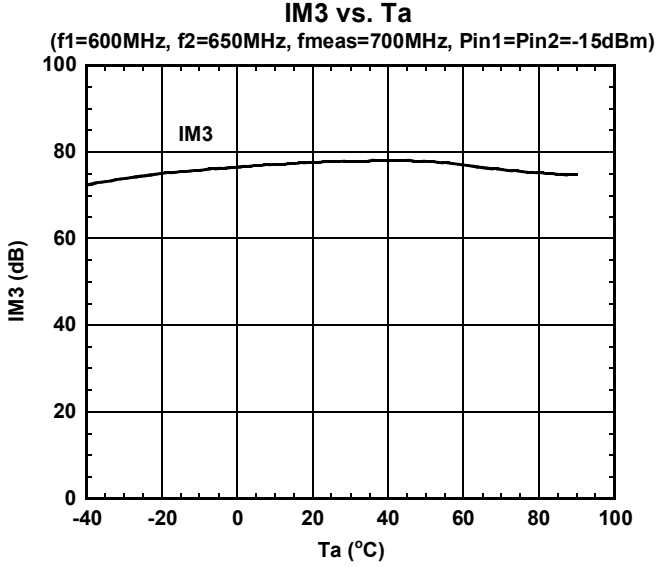
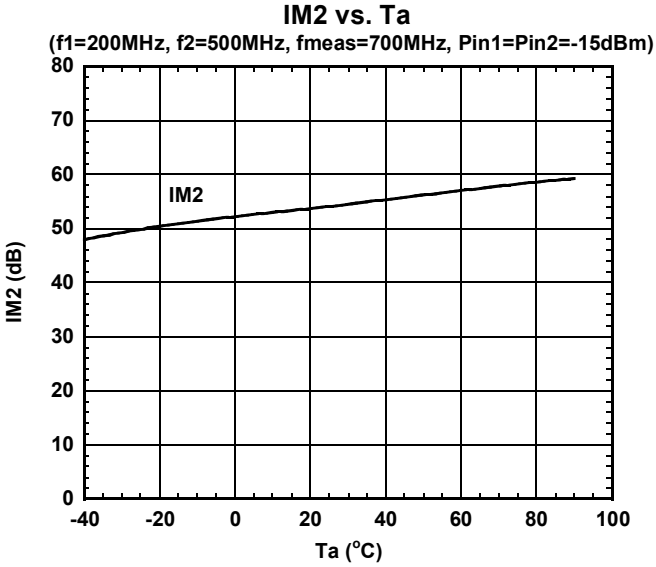

# NJG1146KG1

## ■ ELECTRICAL CHARACTERISTICS (Low Gain mode)

Conditions:  $V_{DD}=5.0V$ ,  $V_{CTL}=0V$ ,  $T_a=25^\circ C$ ,  $Z_s=Z_l=50\text{ ohm}$ , with application circuit

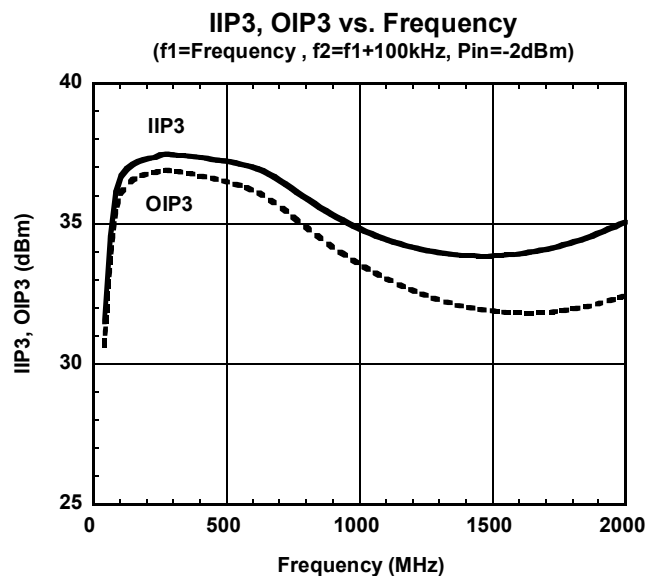
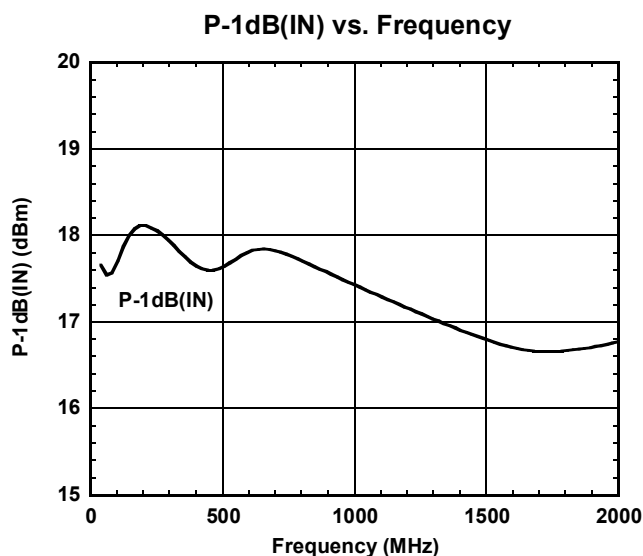
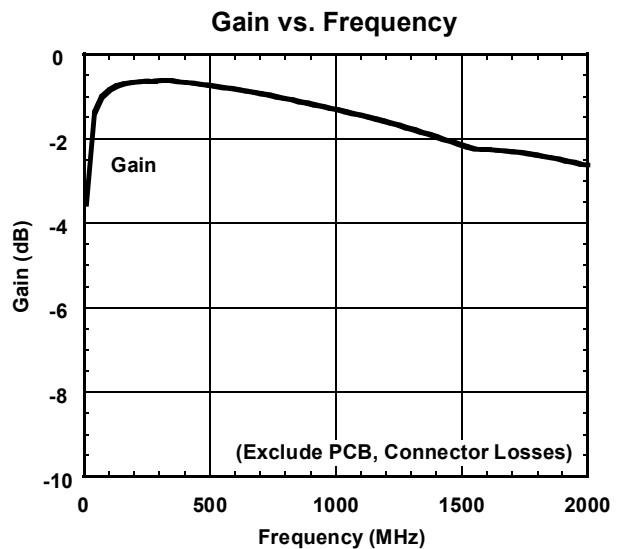
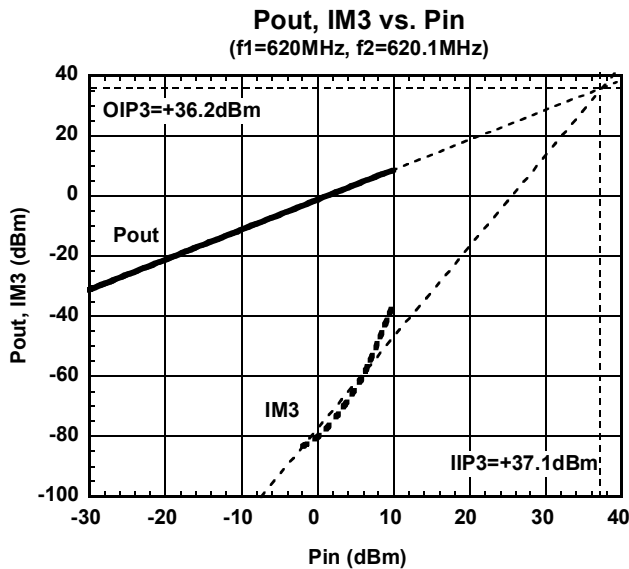
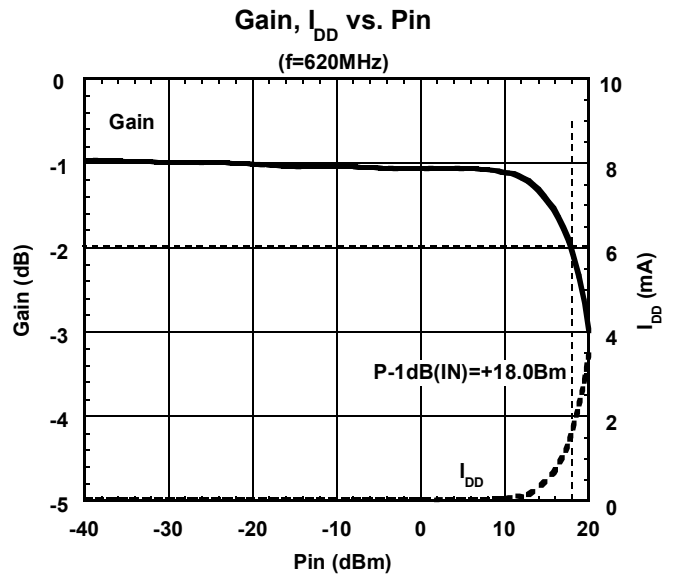
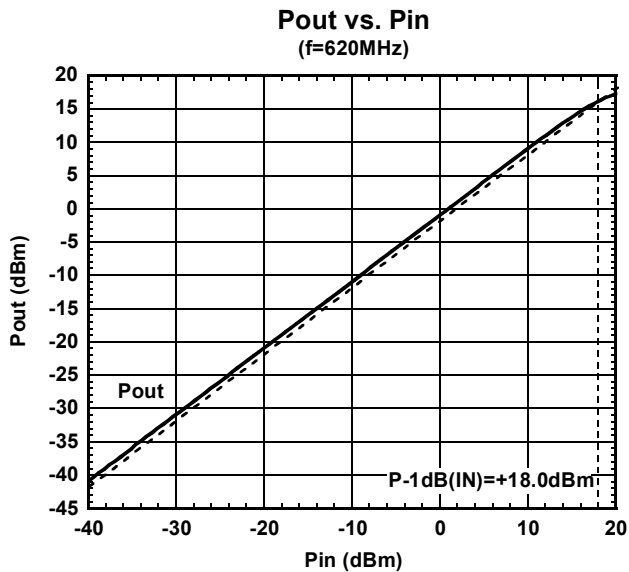

**ELECTRICAL CHARACTERISTICS (Low Gain mode)**

Conditions:  $V_{DD}=5.0V$ ,  $V_{CTL}=0V$ ,  $T_a=25^\circ C$ ,  $Z_s=Z_l=50\ \text{ohm}$ , with application circuit

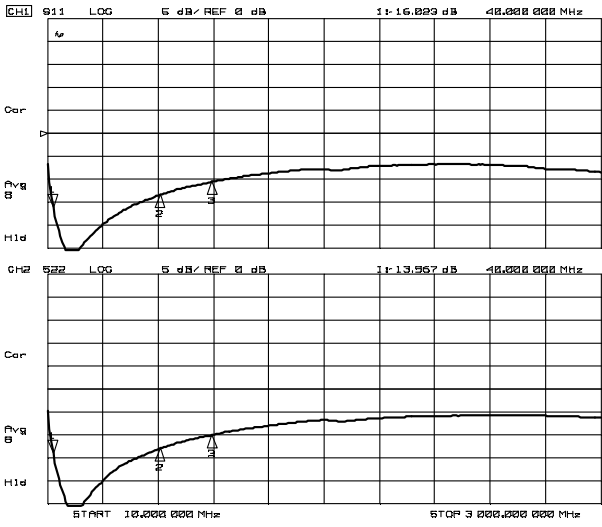

S11, S22 (f=10MHz~3GHz)

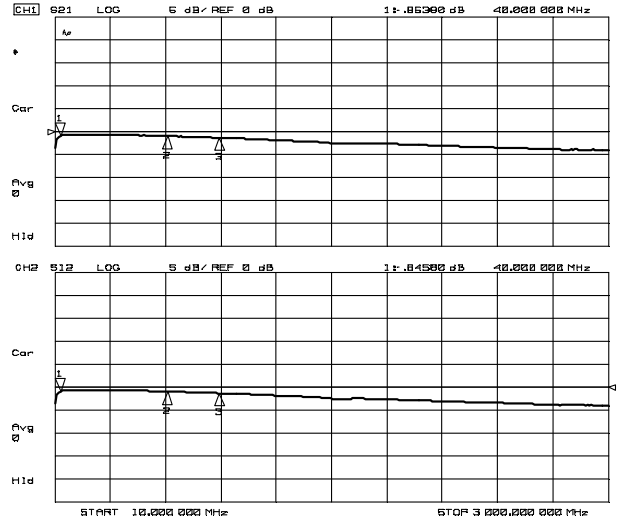

S21, S12 (f=10MHz~3GHz)

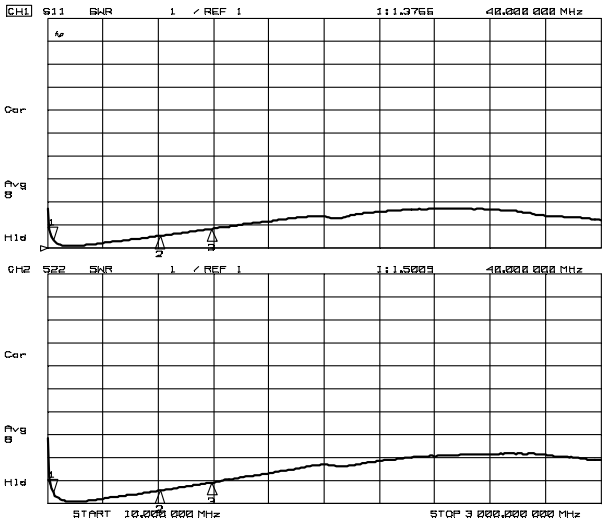

VSWR (f=10MHz~3GHz)

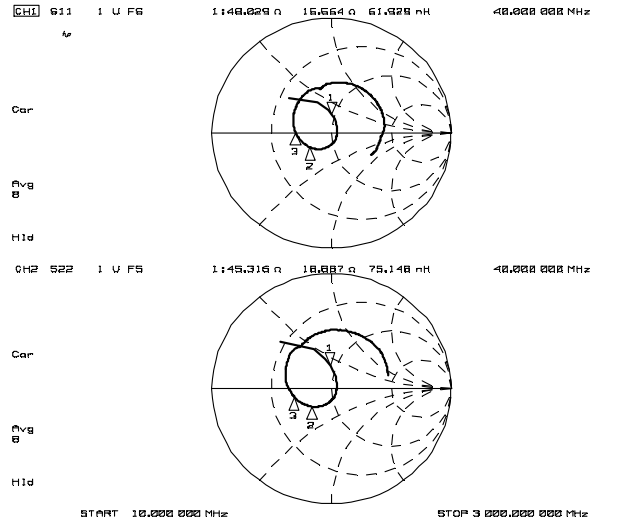

Zin, Zout (f=10MHz~3GHz)

# NJG1146KG1

## ■ ELECTRICAL CHARACTERISTICS (Low Gain mode)

Conditions:  $V_{DD}=5.0V$ ,  $V_{CTL}=0V$ ,  $T_a=25^\circ C$ ,  $Z_s=Z_l=50\text{ ohm}$ , with application circuit

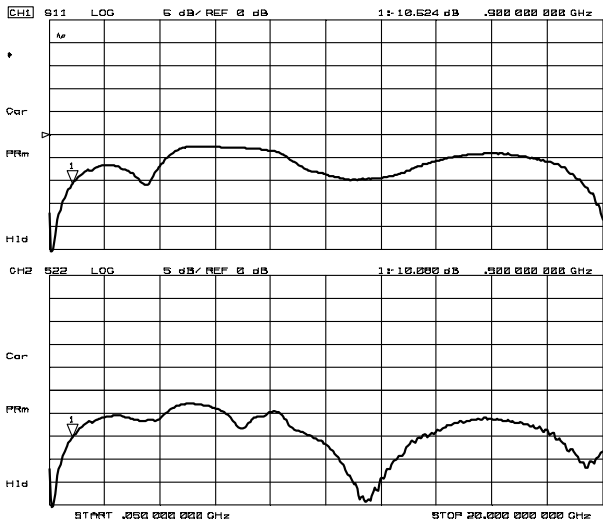

S11, S22 (f=50MHz~20GHz)

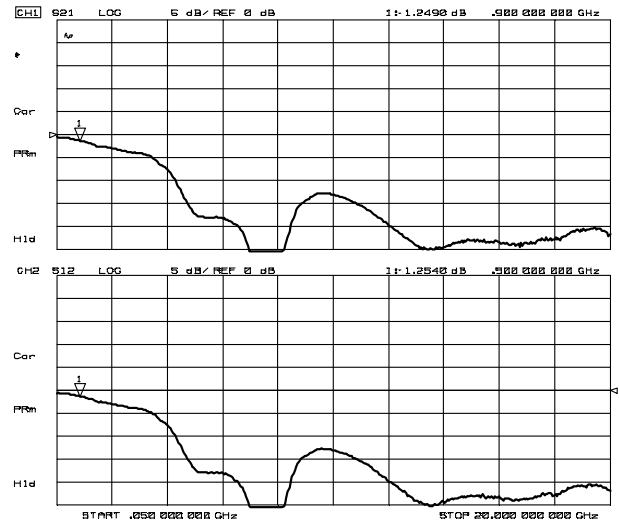

S21, S12 (f=50MHz~20GHz)

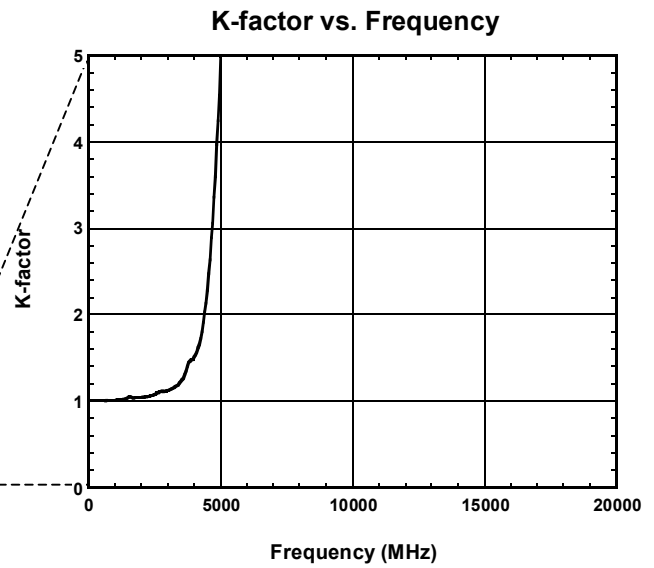
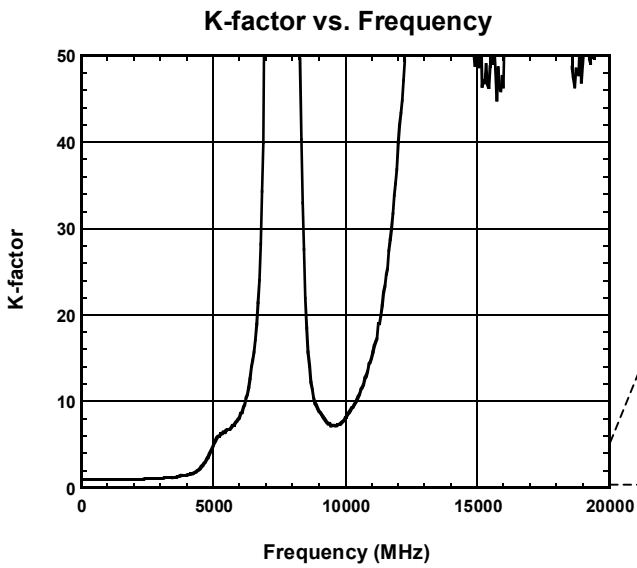



**ELECTRICAL CHARACTERISTICS (Low Gain mode)**

Conditions:  $V_{DD}=5.0V$ ,  $V_{CTL}=0V$ ,  $Z_s=Z_l=50\text{ ohm}$ , with application circuit

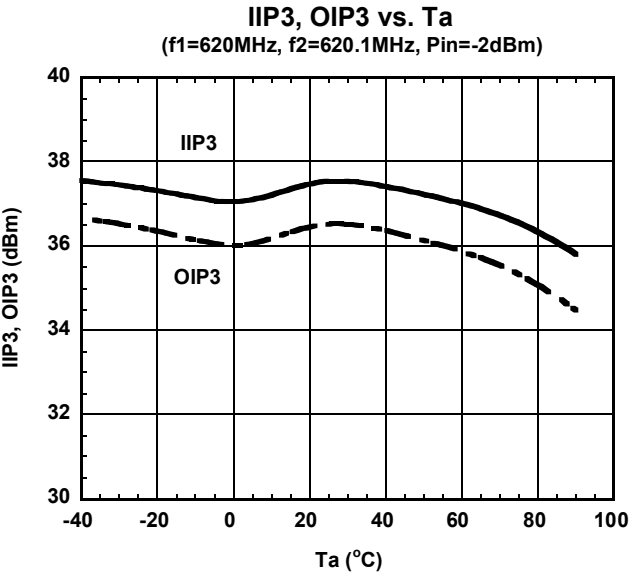
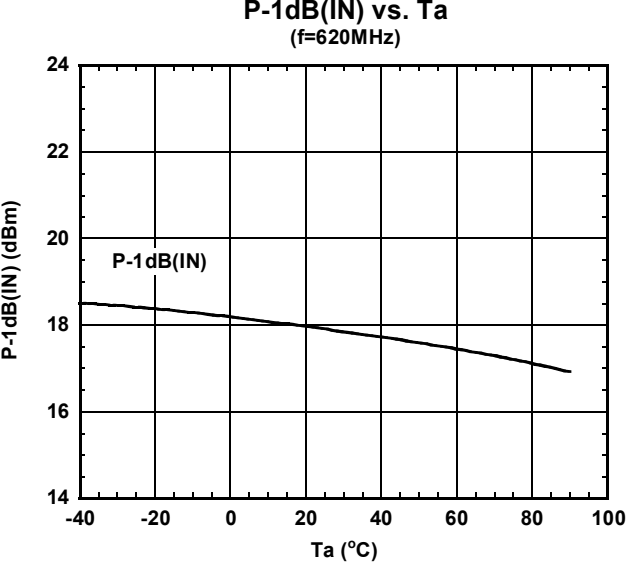
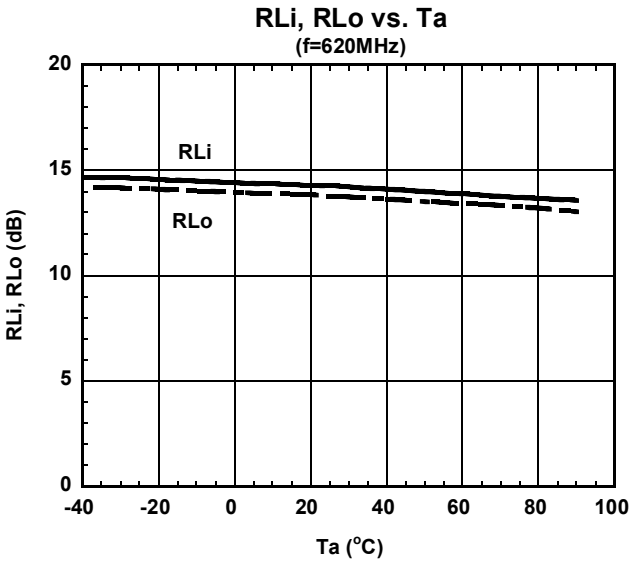
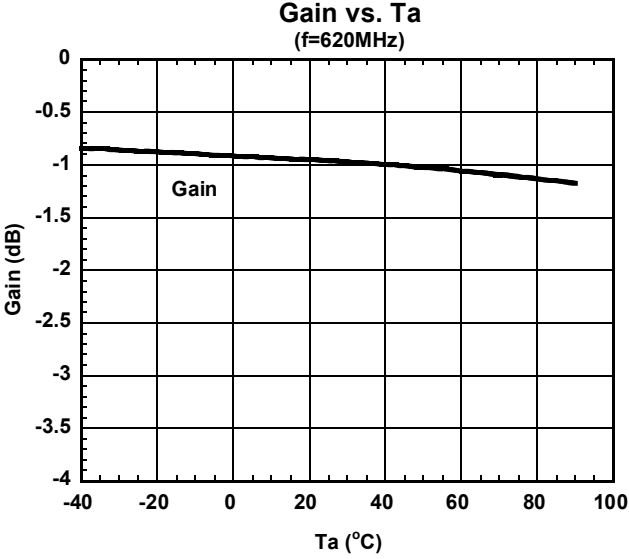
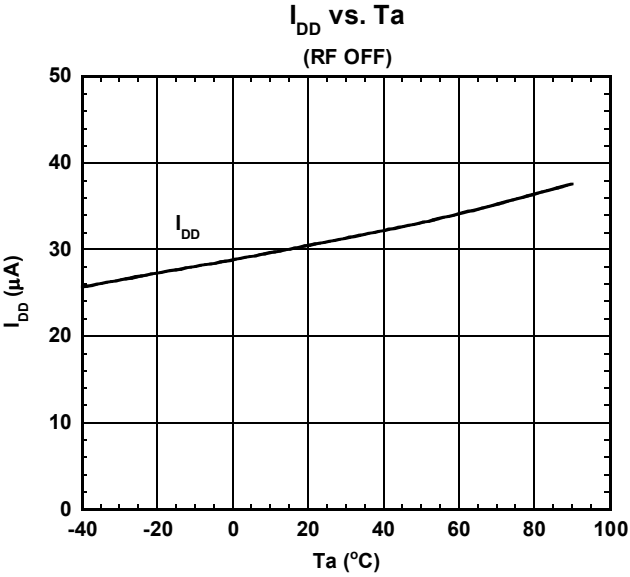

# NJG1146KG1

## ■ ELECTRICAL CHARACTERISTICS (Low Gain mode)

Conditions:  $V_{DD}=5.0V$ ,  $V_{CTL}=0V$ ,  $Z_s=Z_l=50\text{ ohm}$ , with application circuit

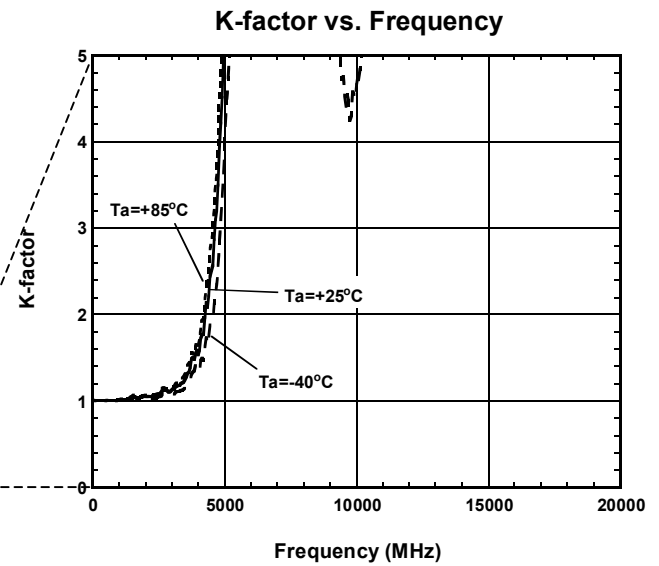
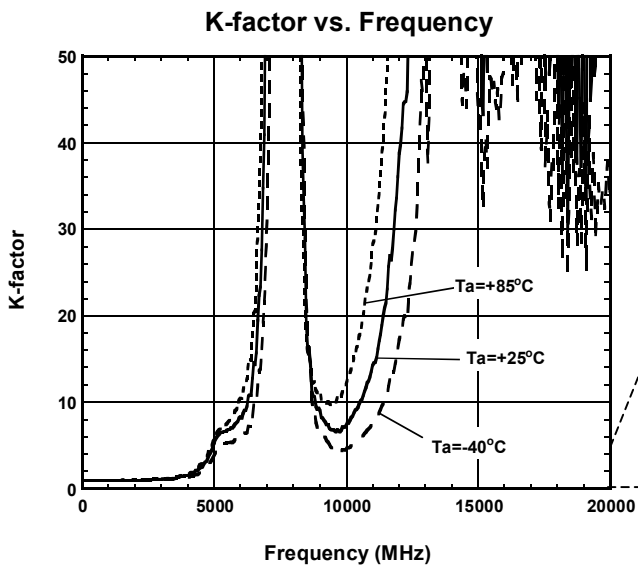
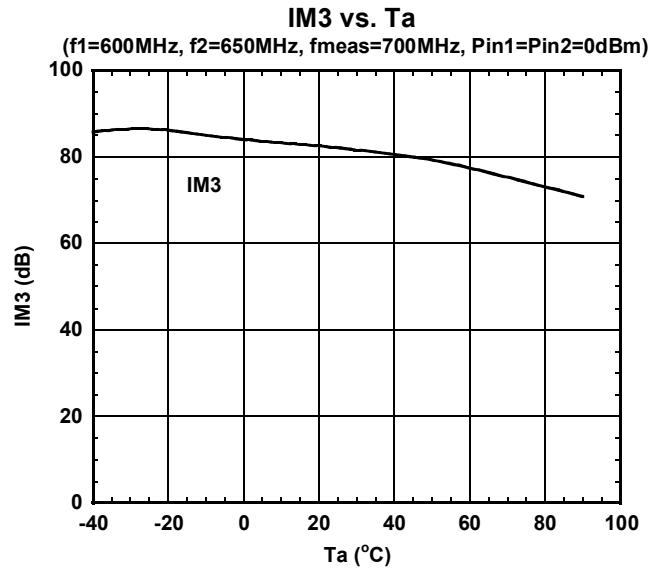
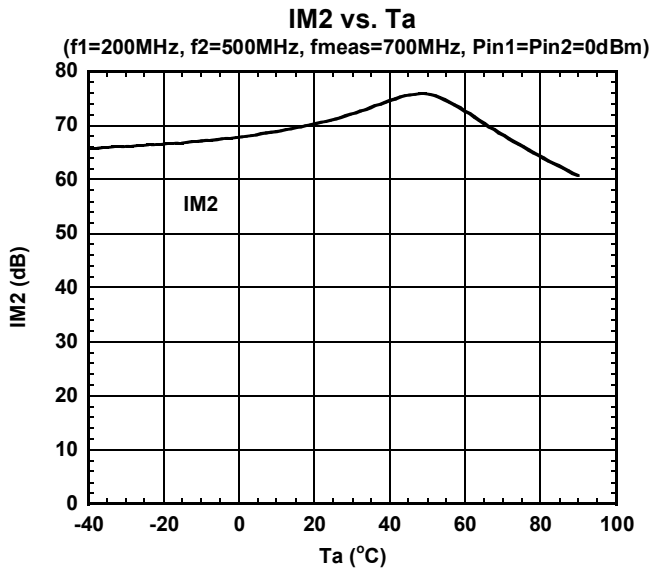

**APPLICATION CIRCUIT**

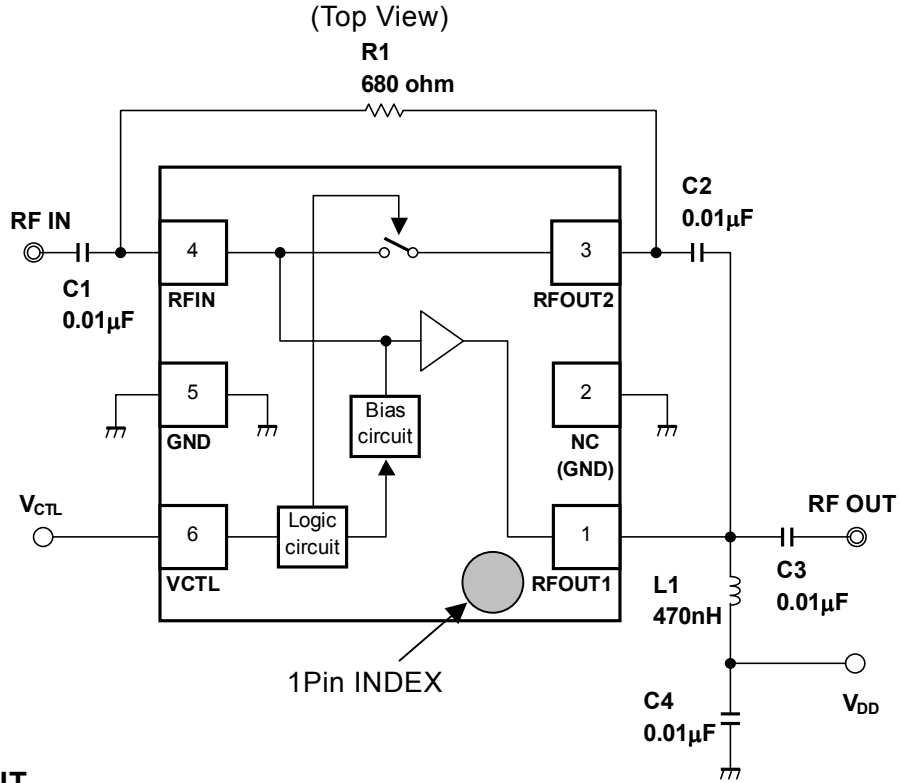

**TEST PCB LAYOUT**

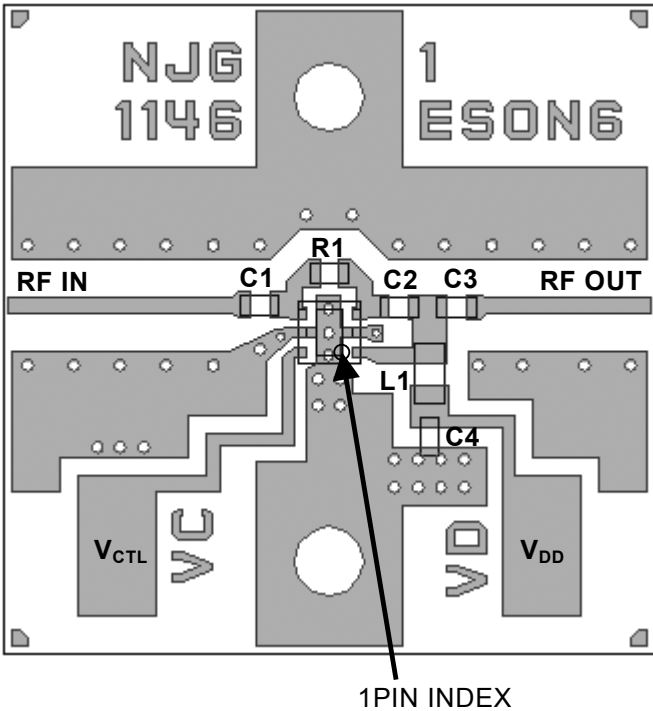

**PARTS LIST**

Parts ID.	Manufacturer
L1	TAIYO-YUDEN HK1608 Series
C1~C4	MURATA GRM15 Series
R1	KOA RK73B Series

PCB (FR-4):  
 t=0.2mm  
 MICROSTRIP LINE WIDTH  
 =0.40mm (Z<sub>0</sub>=50 ohm)  
 PCB SIZE=16.8mm x 16.8mm

**PRECAUTIONS**

- C1~C3 are DC-Blocking capacitors, and L1 is a DC-feed inductor, and C4 is a bypass capacitor.
- L1 is an RF choke. (DC feed inductor)
- Please connect Exposed Pad with GND by using the plated through hole.
- In order not to couple with terminal RFIN and RFOUT, please layout ground pattern under the IC.
- All external parts are placed as close as possible to the IC.

# NJG1146KG1

## MEASUREMENT BLOCK DIAGRAM

### Measuring instruments

NF Analyzer : Agilent 8973A  
Noise Source : Agilent 346A

### Setting the NF analyzer

Measurement mode form

Device under test : Amplifier  
System downconverter : off

Mode setup form

Sideband : LSB  
Averages : 16  
Average mode : Point  
Bandwidth : 4MHz  
Loss comp : off  
Tcold : setting the temperature of noise source (303.15K)

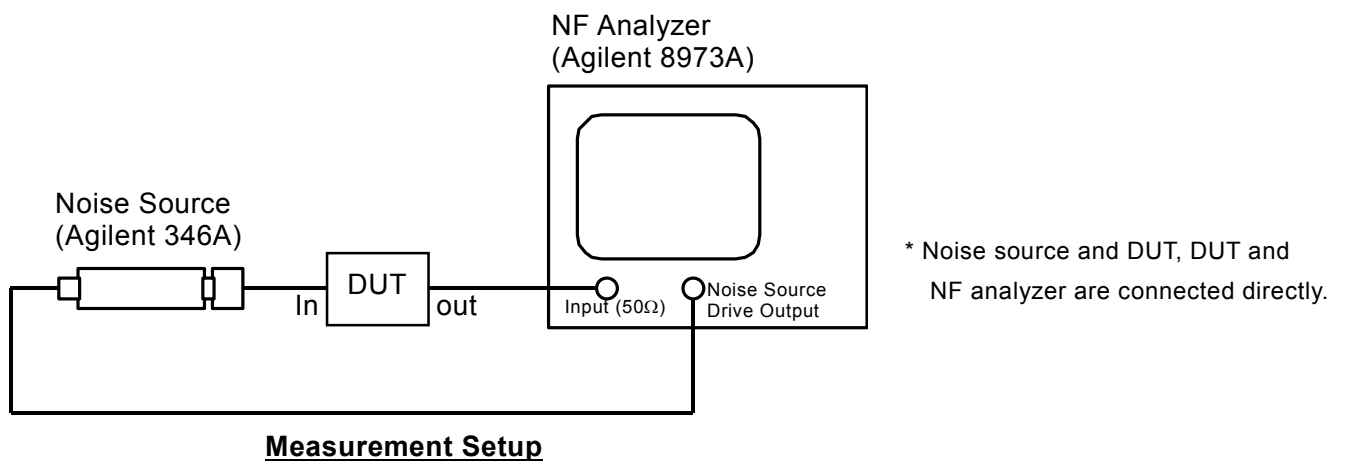
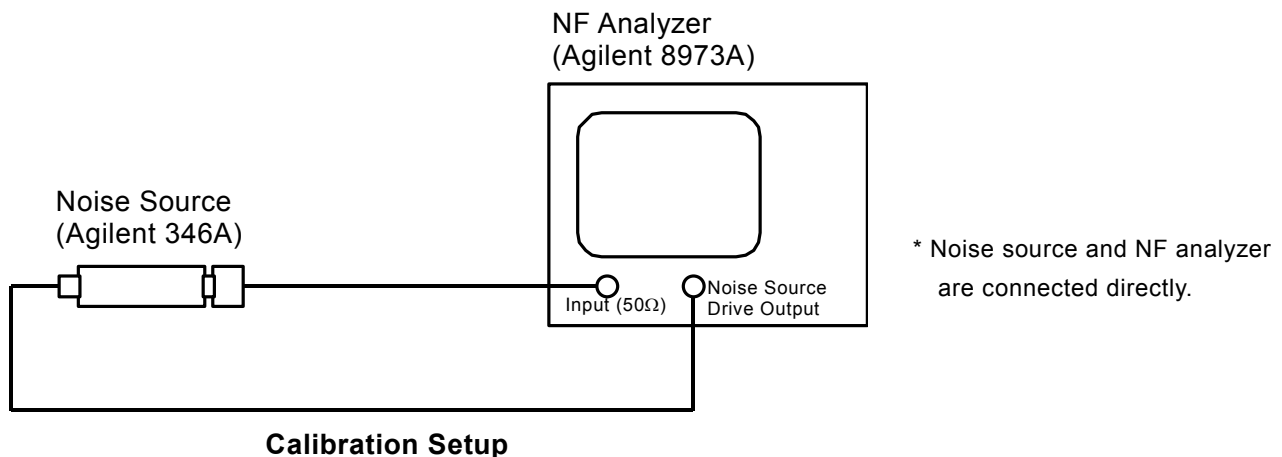

**PACKAGE OUTLINE (ESON14-D7)**

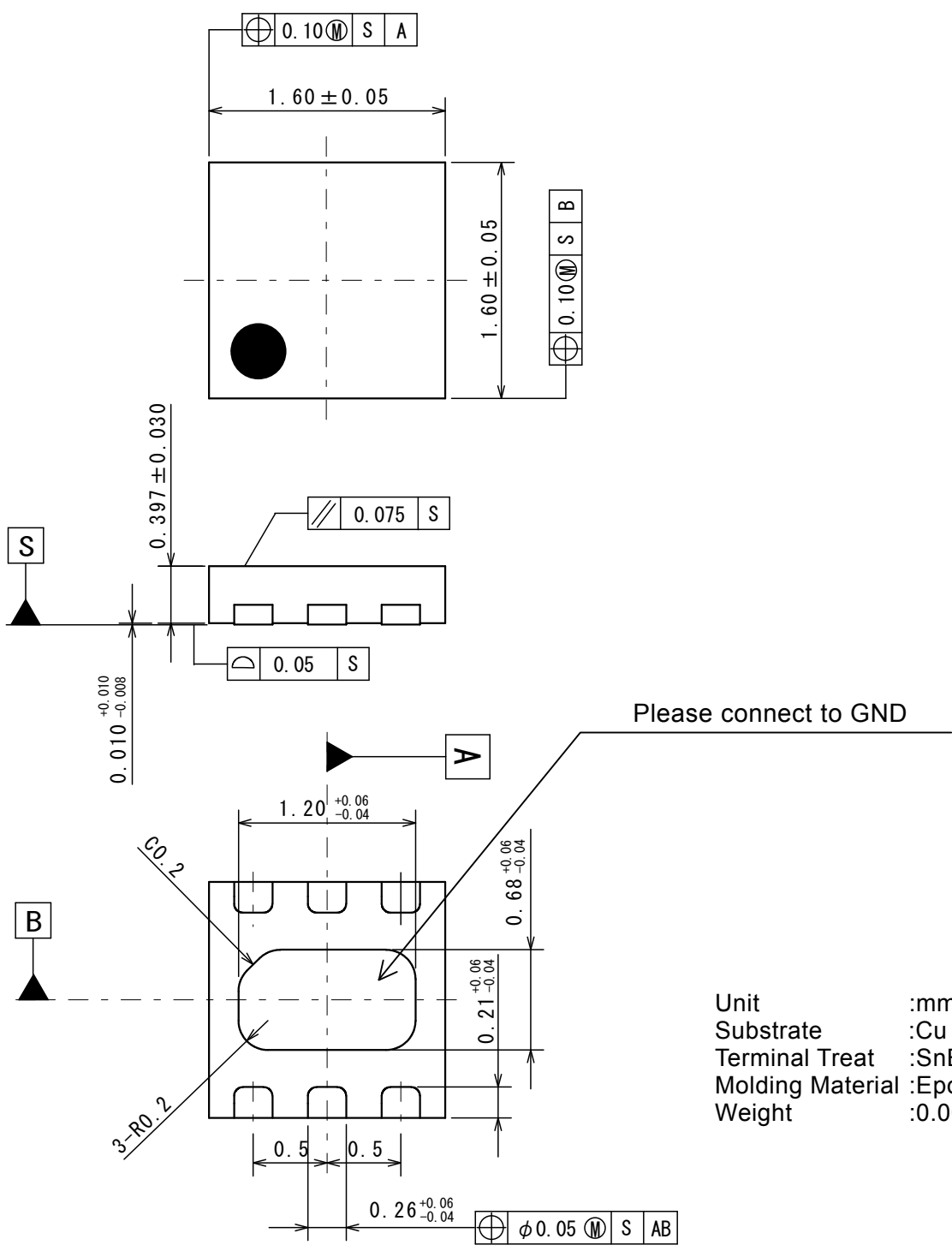

Unit :mm  
 Substrate :Cu  
 Terminal Treat :SnBi  
 Molding Material :Epoxy Resin  
 Weight :0.0035 (g)

**Cautions on using this product**  
 This product contains Gallium-Arsenide (GaAs) which is a harmful material.

- Do NOT eat or put into mouth.
- Do NOT dispose in fire or break up this product.
- Do NOT chemically make gas or powder with this product.
- To waste this product, please obey the relating law of your country.

**[CAUTION]**  
 The specifications on this databook are only given for information, without any guarantee as regards either mistakes or omissions. The application circuits in this databook are described only to show representative usages of the product and not intended for the guarantee or permission of any right including the industrial rights.

This product may be damaged with electric static discharge (ESD) or spike voltage. Please handle with care to avoid these damages.