

## UHF BAND LOW NOISE AMPLIFIER GaAs MMIC

### ■ GENERAL DESCRIPTION

NJG1134HA8 is a low noise amplifier GaAs MMIC designed for mobile digital TV application (470~770 MHz).

This IC has a LNA pass-through function to select high gain mode or low gain mode by single bit control.

Also, this IC is integrated the ESD protection circuit.

An ultra-small and ultra-thin package of USB6-A8 is adopted.

### ■ PACKAGE OUTLINE

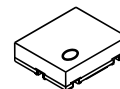

NJG1134HA8

### ■ FEATURES

- Low voltage operation +2.8V typ.
  - Low voltage control +1.8V typ.
  - Package USB6-A8 (Package size: 1mm x 1.2mm x 0.38mm typ.)
- [High gain mode]
- Low current consumption 4.0mA typ.
  - Gain 10.0dB typ.
  - Low noise figure 1.2dB typ. @  $f_{RF}=470\sim 620\text{MHz}$
  - High input IP3 +5.0dBm typ.
- [Low gain mode]
- Low current consumption 10 $\mu$ A typ.
  - Gain -0.6dB typ.
  - High input IP3 +23.0dBm typ.

### ■ PIN CONFIGURATION

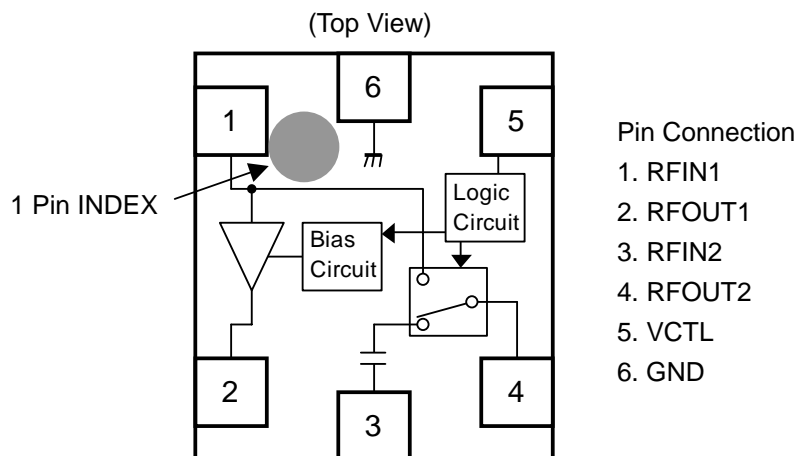

### ■ TRUTH TABLE

"H"= $V_{CTL(H)}$ , "L"= $V_{CTL(L)}$

$V_{CTL}$	LNA Mode
H	High Gain mode
L	Low Gain mode

Note: Specifications and description listed in this datasheet are subject to change without notice.

# NJG1134HA8

## ■ ABSOLUTE MAXIMUM RATINGS

$T_a=+25^{\circ}\text{C}$ ,  $Z_s=Z_i=50\text{ ohm}$

PARAMETER	SYMBOL	CONDITIONS	RATINGS	UNITS
Drain voltage	$V_{DD}$		5.0	V
Control voltage	$V_{CTL}$		5.0	V
Input power	$P_{IN}$	$V_{DD}=2.8\text{V}$	+15	dBm
Power dissipation	$P_D$	On PCB board, $T_{jmax}=150^{\circ}\text{C}$	150	mW
Operating temperature	$T_{opr}$		-40~+95	$^{\circ}\text{C}$
Storage temperature	$T_{stg}$		-55~+150	$^{\circ}\text{C}$

## ■ ELECTRICAL CHARACTERISTICS<sup>1</sup> (DC CHARACTERISTICS)

General conditions:  $V_{DD}=2.8\text{V}$ ,  $T_a=+25^{\circ}\text{C}$ ,  $Z_s=Z_i=50\text{ ohm}$ , with application circuit.

PARAMETERS	SYMBOL	CONDITIONS	MIN	TYP	MAX	UNITS
Operating voltage	$V_{DD}$		2.3	2.8	3.6	V
Control voltage (High)	$V_{CTL(H)}$	High Gain mode	1.3	1.8	3.6	V
Control voltage (Low)	$V_{CTL(L)}$	Low Gain mode	0	0	0.5	V
Operating current <sup>1</sup>	$I_{DD1}$	RF OFF, $V_{CTL}=1.8\text{V}$	-	4.0	5.6	mA
Operating current <sup>2</sup>	$I_{DD2}$	RF OFF, $V_{CTL}=0.0\text{V}$	-	10.0	25.0	$\mu\text{A}$
Control current	$I_{CTL}$	RF OFF, $V_{CTL}=1.8\text{V}$	-	6.0	10.0	$\mu\text{A}$

## ■ ELECTRICAL CHARACTERISTICS2 (High Gain mode)

General conditions:  $V_{DD}=2.8V$ ,  $V_{CTL}=1.8V$ ,  $T_a=+25^{\circ}C$ ,  $Z_s=Z_l=50\text{ ohm}$ , with application circuit.

PARAMETERS	SYMBOL	CONDITIONS	MIN	TYP	MAX	UNITS
Operating frequency	$f_{RF}$		470	620	770	MHz
Small signal gain1	Gain1		9.0	10.0	12.5	dB
Gain flatness	$G_{flat}$		-	1.1	1.6	dB
Noise figure1	NF1	Exclude PCB & connector losses, $f_{RF}=470\sim 620\text{MHz}^*1$	-	1.20	1.45	dB
Noise figure2	NF2	Exclude PCB & connector losses, $f_{RF}=620\sim 710\text{MHz}^*1$	-	1.25	1.50	dB
Noise figure3	NF3	Exclude PCB & connector losses, $f_{RF}=710\sim 770\text{MHz}^*1$	-	1.30	1.55	dB
Input power at 1dB gain compression point1	P-1dB(IN)1		-9.0	-5.0	-	dBm
Input 3rd order intercept point1	IIP3_1	$f1=f_{RF}$ , $f2=f_{RF}+100\text{kHz}$ , $P_{IN}=-28\text{dBm}$	+0.0	+5.0	-	dBm
RF IN VSWR1	VSWRi1		-	2.7	3.3	
RF OUT VSWR1	VSWRo1		-	3.0	3.8	

## ■ ELECTRICAL CHARACTERISTICS3 (Low Gain mode)

General conditions:  $V_{DD}=2.8V$ ,  $V_{CTL}=0V$ ,  $T_a=+25^{\circ}C$ ,  $Z_s=Z_l=50\text{ ohm}$ , with application circuit.

PARAMETERS	SYMBOL	CONDITIONS	MIN	TYP	MAX	UNITS
Operating frequency	$f_{RF}$		470	620	770	MHz
Small signal gain2	Gain2	Exclude PCB & connector losses*2	-1.8	-0.6	-	dB
Input power at 1dB gain compression point2	P-1dB(IN)2		-3.0	+4.0	-	dBm
Input 3rd order intercept point2	IIP3_2	$f1=f_{RF}$ , $f2=f_{RF}+100\text{kHz}$ , $P_{IN}=-15\text{dBm}$	+10.0	+23.0	-	dBm
RF IN VSWR2	VSWRi2		-	1.2	1.5	
RF OUT VSWR2	VSWRo2		-	1.2	1.5	

\*1 Input PCB and connector losses: 0.036dB(at 470MHz), 0.053dB(at 770MHz)

\*2 Input-output PCB and connector losses: 0.072dB(at 470MHz), 0.105dB(at 770MHz)

# NJG1134HA8

## ■ TERMINAL INFORMATION

No.	SYMBOL	DESCRIPTION
1	RFIN1	RF input terminal. The RF signal is input through the external matching circuit. This terminal is connected with the ground through L1 shown in the application circuit.
2	RFOUT1	At the High gain mode, RF signal comes out from this terminal, and is input into RFIN2 terminal through L2. Please supply power through L3 shown in the application circuit since this terminal also function supply voltage terminal.
3	RFIN2	At the High gain mode, RF signal comes out from RFOUT1 terminal, and is input into this terminal. Please connect this terminal with RFOUT1 terminal through L2 shown in the application circuit.
4	RFOUT2	RF output terminal. External capacitor C3 is required to block the DC bias voltage of internal circuit.
5	VCTL	Control voltage supply terminal.
6	GND	Ground terminal.

\* RF signal input terminal is RFIN1, and the RF signal output terminal is RFOUT2.

## ■ ELECTRICAL CHARACTERISTICS (High Gain mode)

Conditions:  $T_a=+25^{\circ}\text{C}$ ,  $V_{\text{DD}}=2.8\text{V}$ ,  $V_{\text{CTL}}=1.8\text{V}$ ,  $Z_s=Z_l=50\text{ ohm}$ , with application circuit.

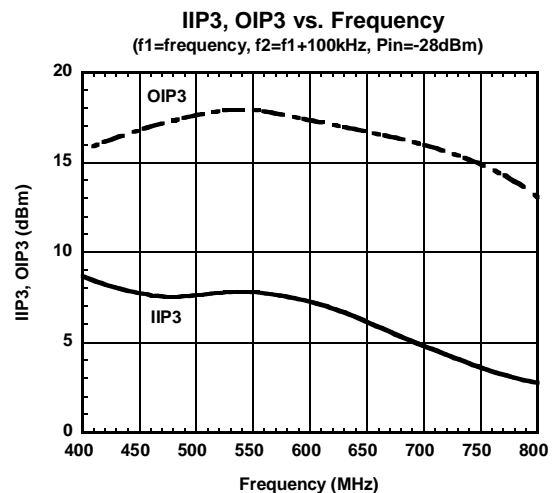
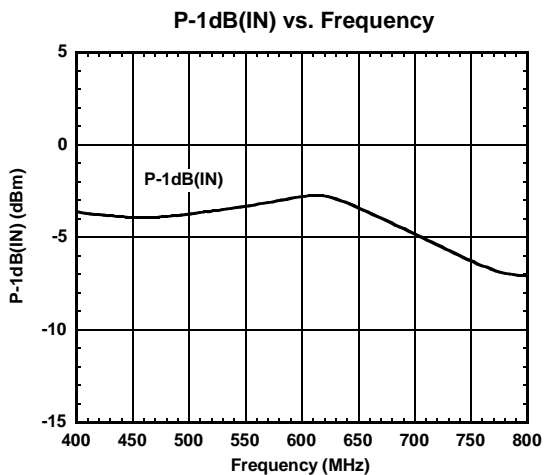
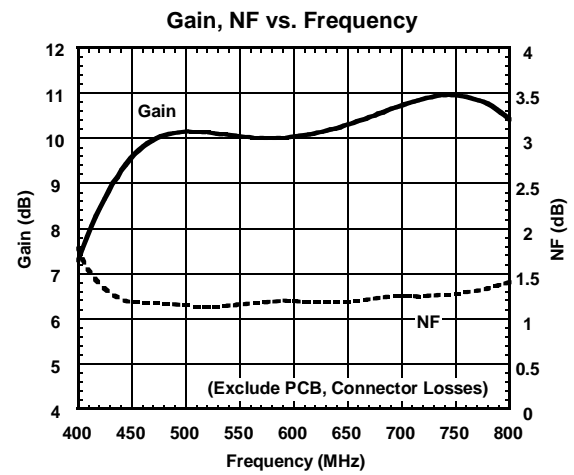
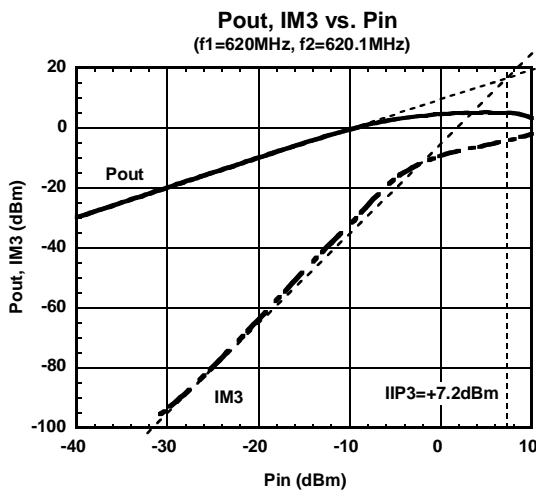
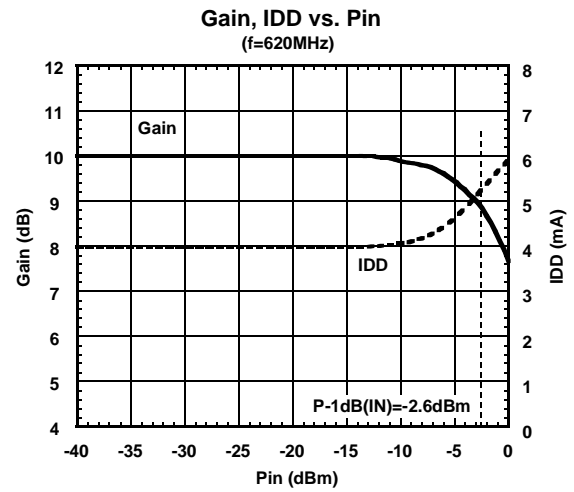
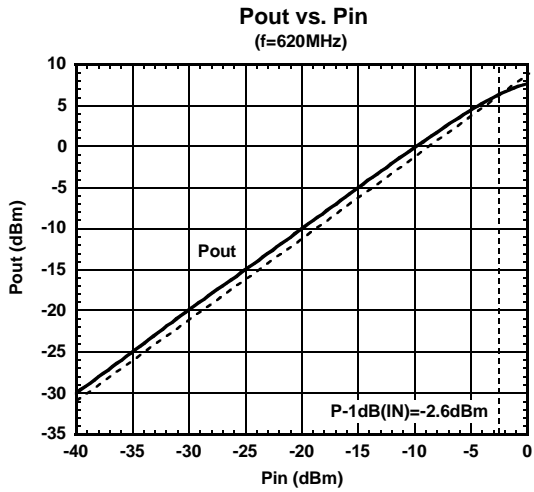

# NJG1134HA8

## ■ ELECTRICAL CHARACTERISTICS (High Gain mode)

Conditions:  $T_a=+25^{\circ}\text{C}$ ,  $V_{\text{DD}}=2.8\text{V}$ ,  $V_{\text{CTL}}=1.8\text{V}$ ,  $Z_s=Z_l=50\text{ ohm}$ , with application circuit.

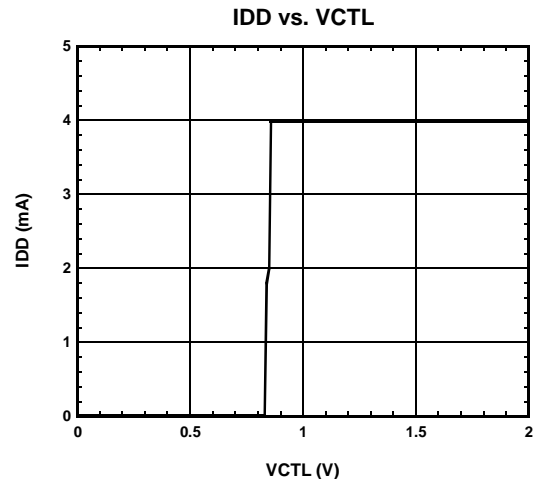
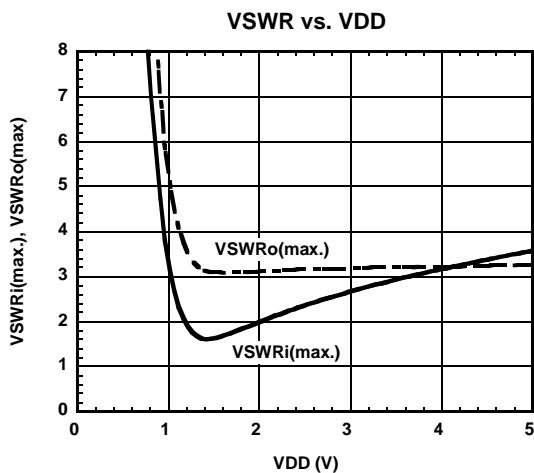
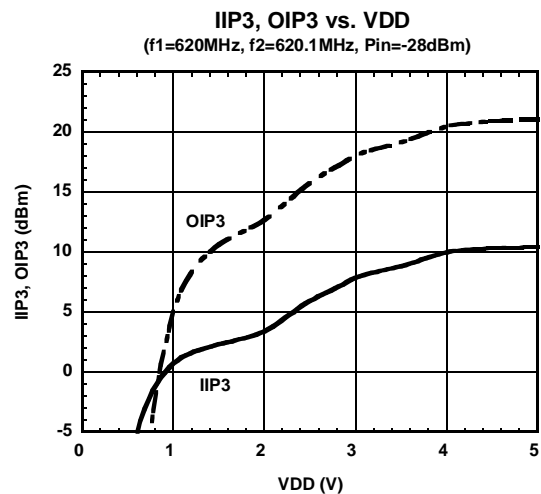
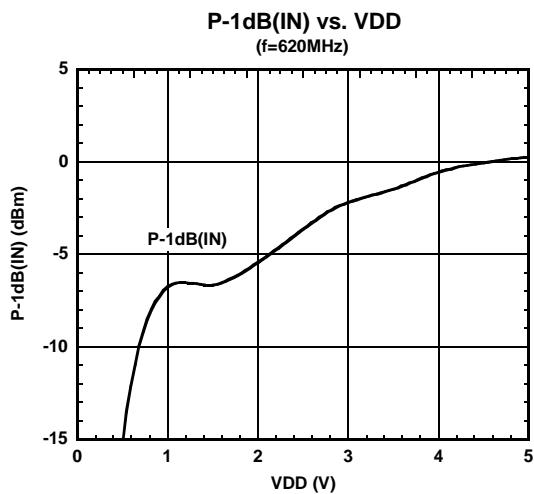
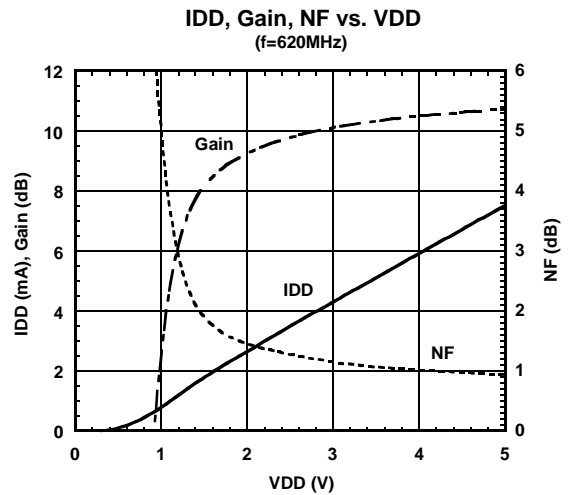
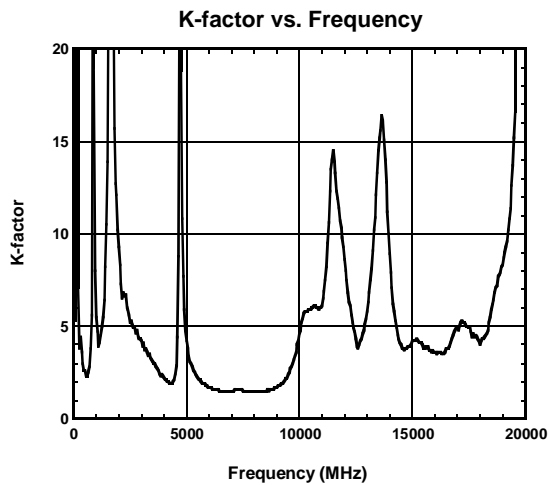

## ■ ELECTRICAL CHARACTERISTICS (High Gain mode)

Conditions:  $V_{DD}=2.8V$ ,  $V_{CTL}=1.8V$ ,  $Z_s=Z_l=50\ \text{ohm}$ , with application circuit.

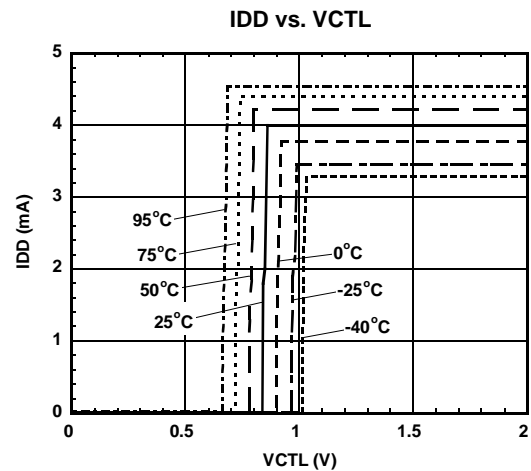
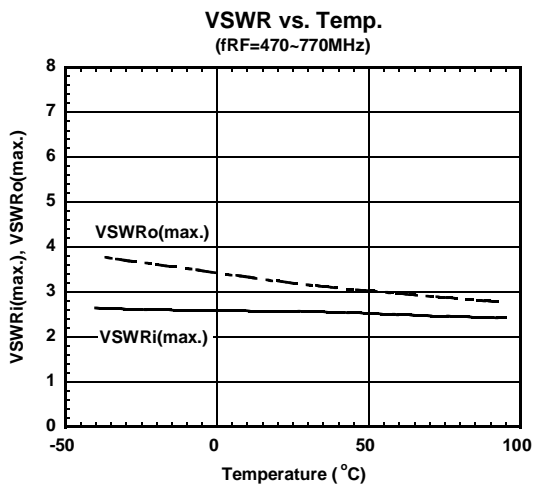
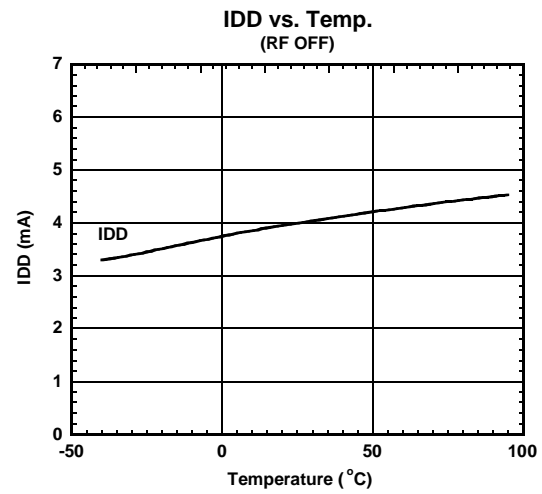
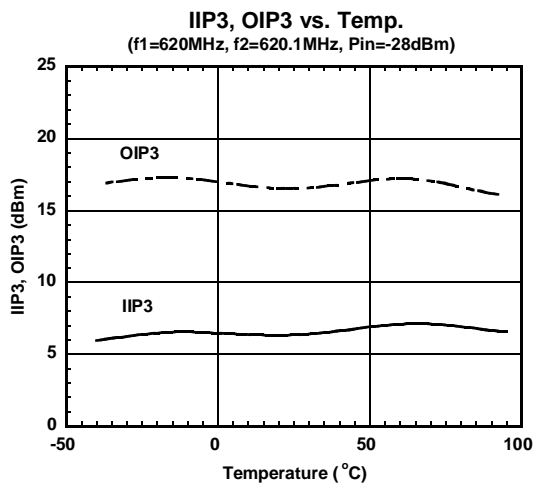
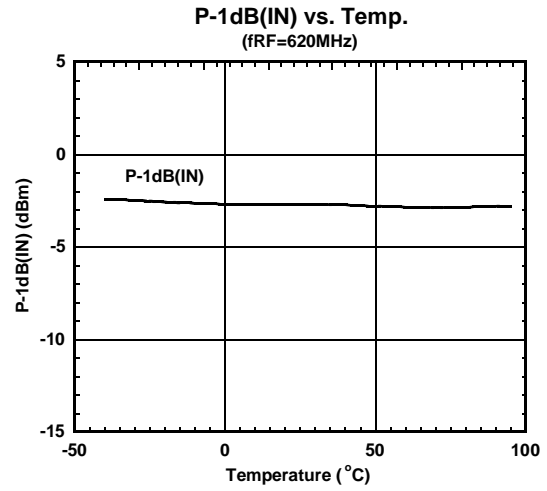
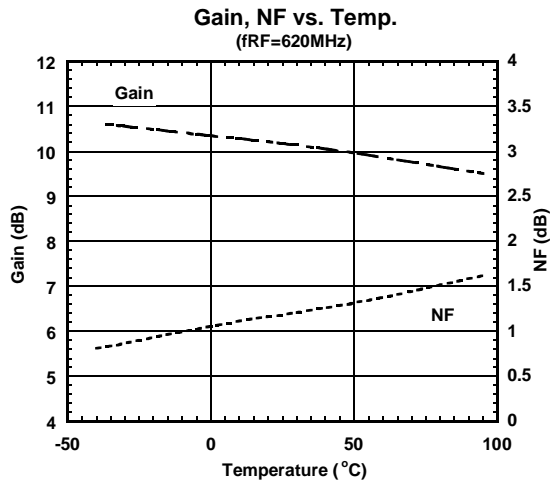

# NJG1134HA8

## ■ ELECTRICAL CHARACTERISTICS (High Gain mode)

Conditions:  $T_a=+25^\circ\text{C}$ ,  $V_{DD}=2.8\text{V}$ ,  $V_{CTL}=1.8\text{V}$ ,  $Z_s=Z_l=50\text{ ohm}$ , with application circuit.

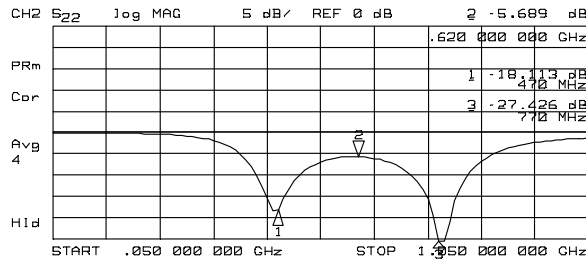
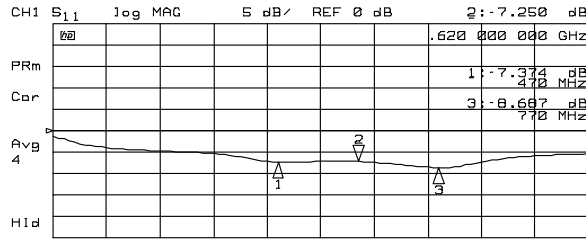

S11, S22

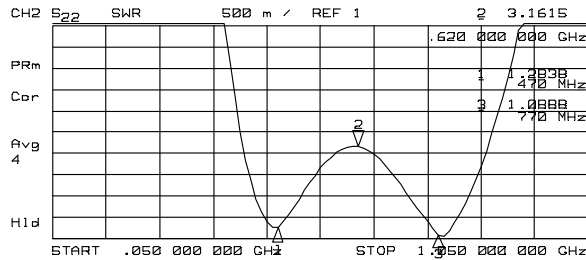
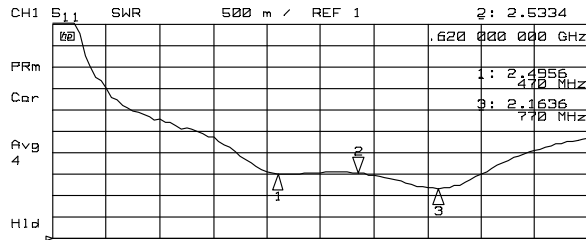

VSWR

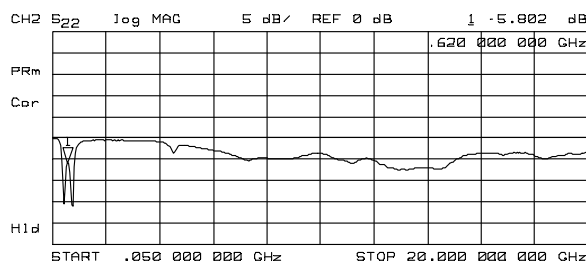
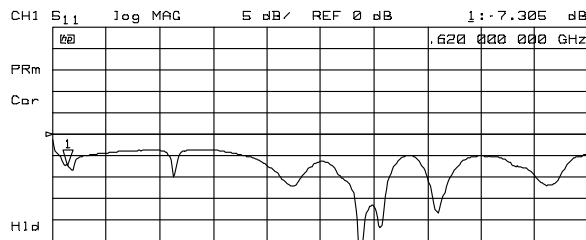

S11, S22 (50MHz~20GHz)

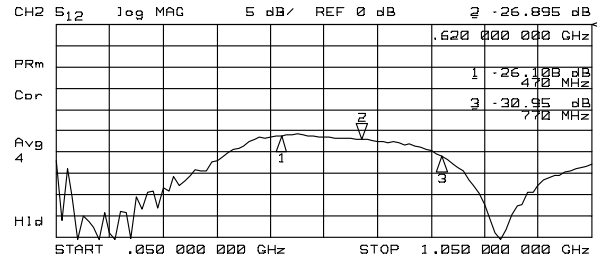
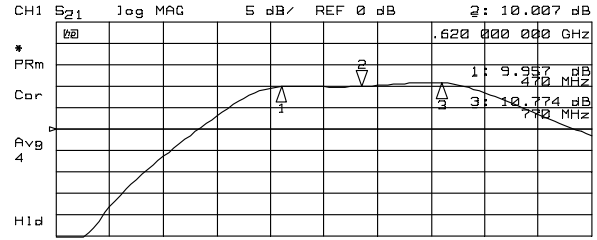

S21, S12

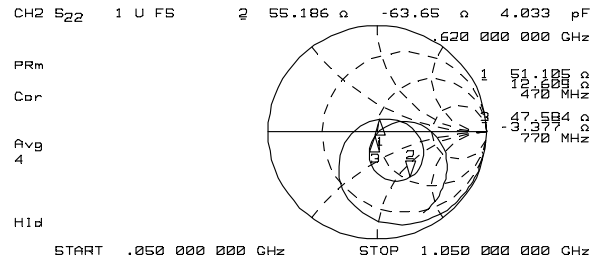
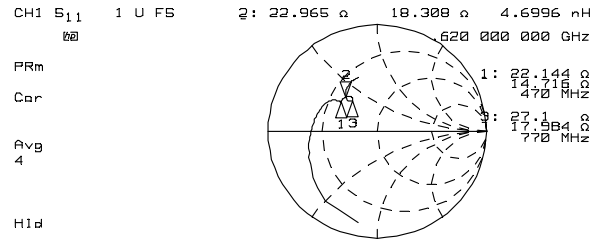

Zin, Zout

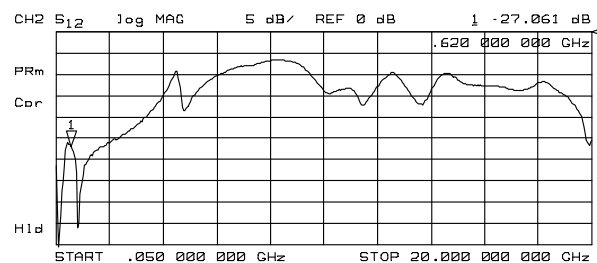
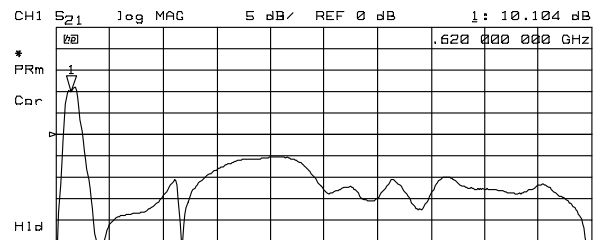

S21, S12 (50MHz~20GHz)



## ■ ELECTRICAL CHARACTERISTICS (Low Gain mode)

Conditions:  $T_a=+25^{\circ}\text{C}$ ,  $V_{\text{DD}}=2.8\text{V}$ ,  $V_{\text{CTL}}=0\text{V}$ ,  $Z_s=Z_l=50\text{ ohm}$ , with application circuit.

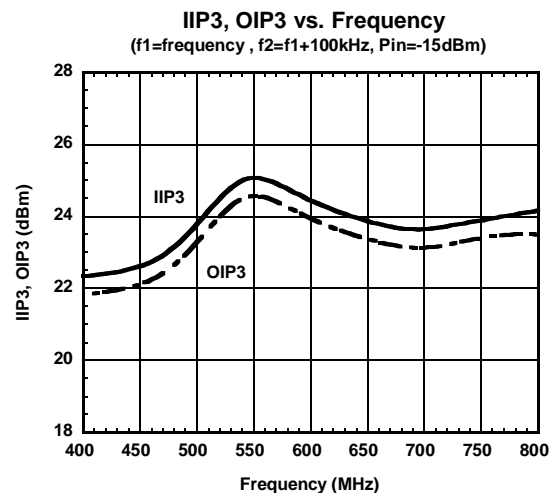
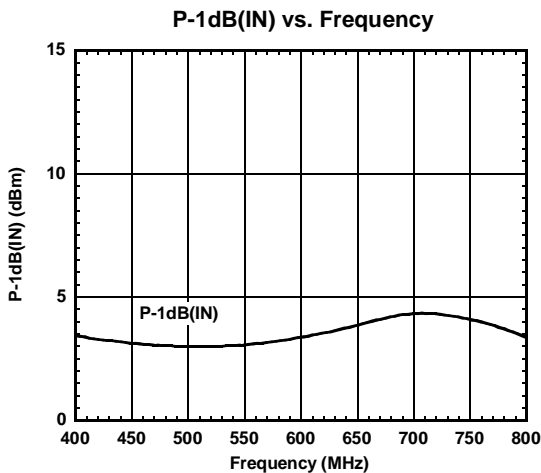
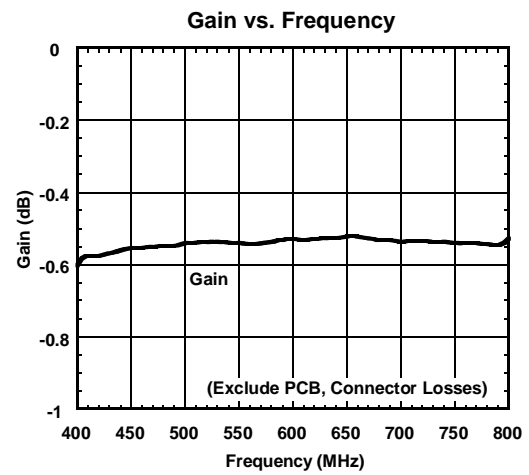
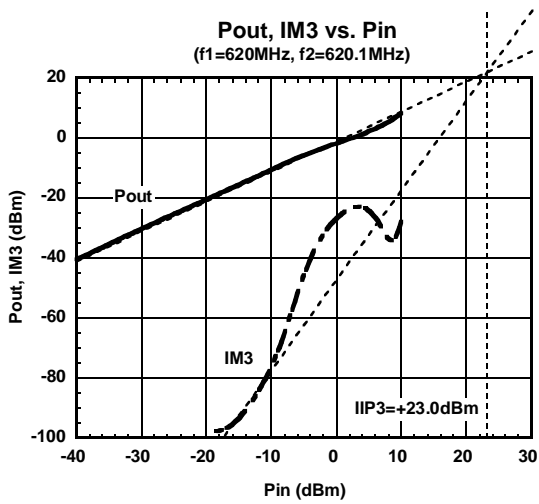
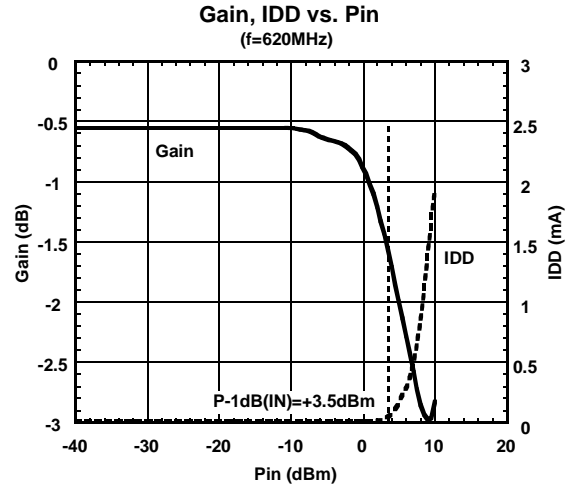
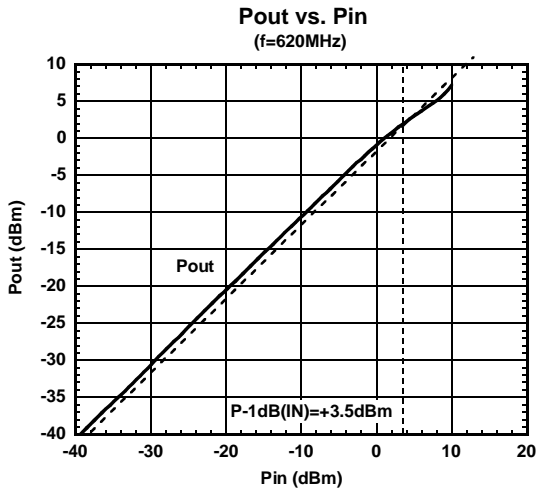

# NJG1134HA8

■ ELECTRICAL CHARACTERISTICS (Low Gain mode)

Conditions:  $T_a=+25^{\circ}\text{C}$ ,  $V_{DD}=2.8\text{V}$ ,  $V_{CTL}=0\text{V}$ ,  $Z_s=Z_l=50\text{ ohm}$ , with application circuit.

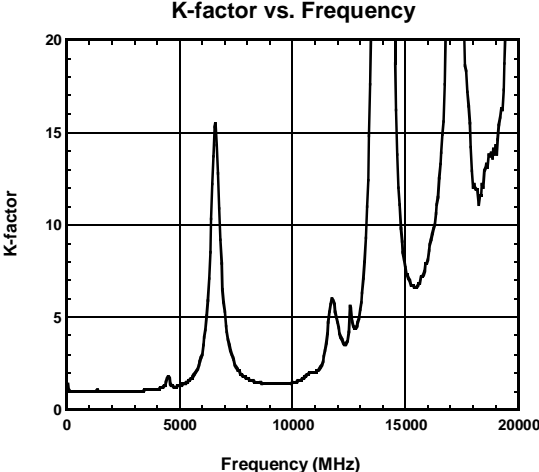

## ■ ELECTRICAL CHARACTERISTICS (Low Gain mode)

Conditions:  $V_{DD}=2.8V$ ,  $V_{CTL}=0V$ ,  $Z_s=Z_l=50\text{ ohm}$ , with application circuit.

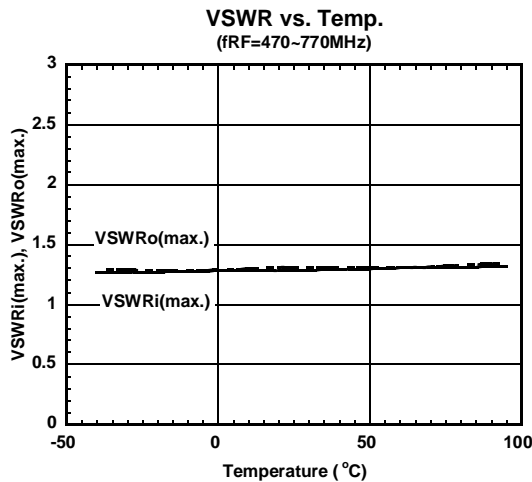
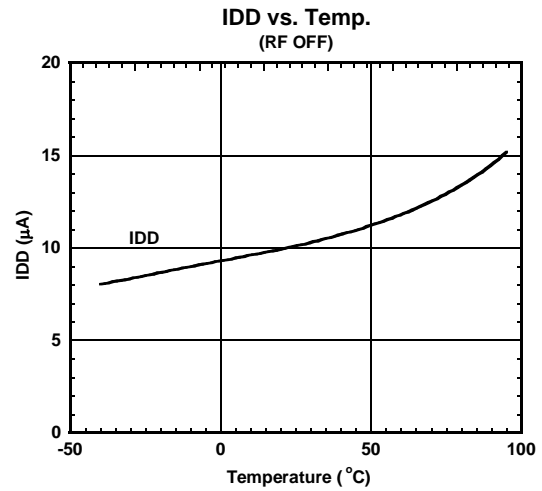
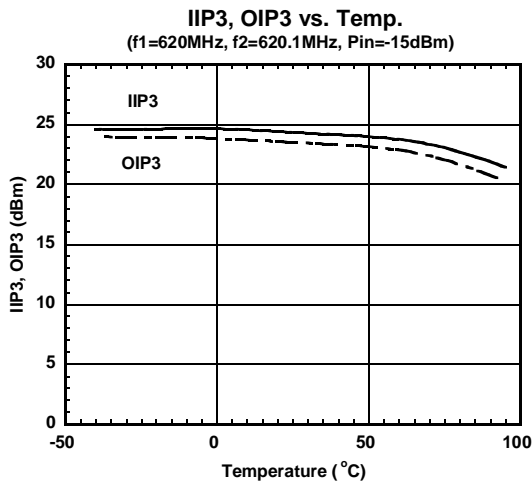
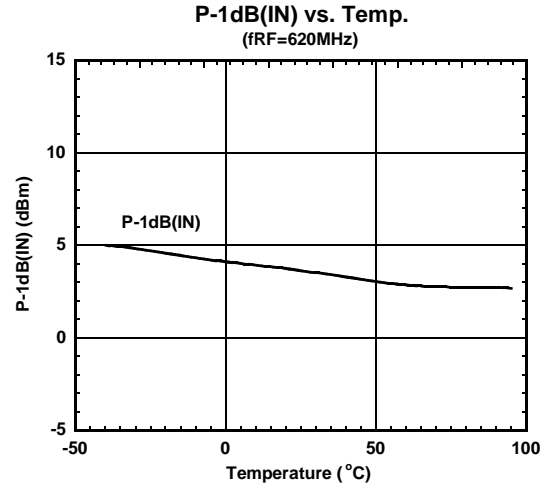
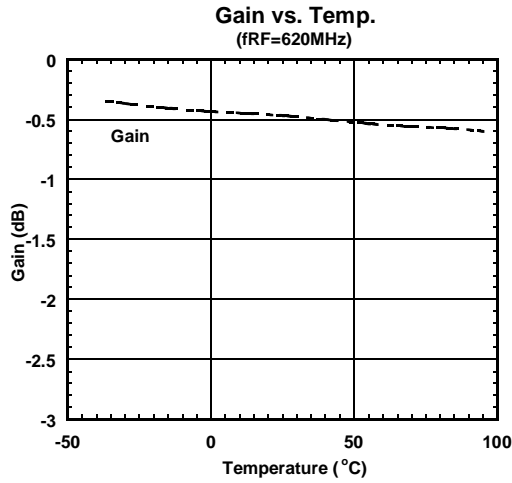

# NJG1134HA8

## ELECTRICAL CHARACTERISTICS (Low Gain mode)

Conditions:  $T_a=+25^\circ\text{C}$ ,  $V_{DD}=2.8\text{V}$ ,  $V_{CTL}=0\text{V}$ ,  $Z_s=Z_l=50\text{ohm}$ , with application circuit.

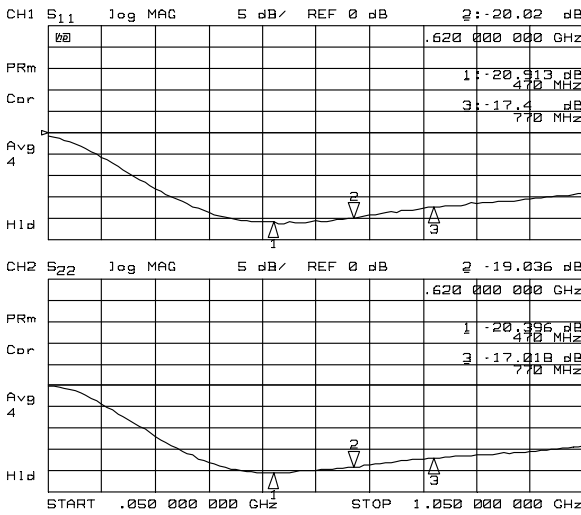

S11, S22

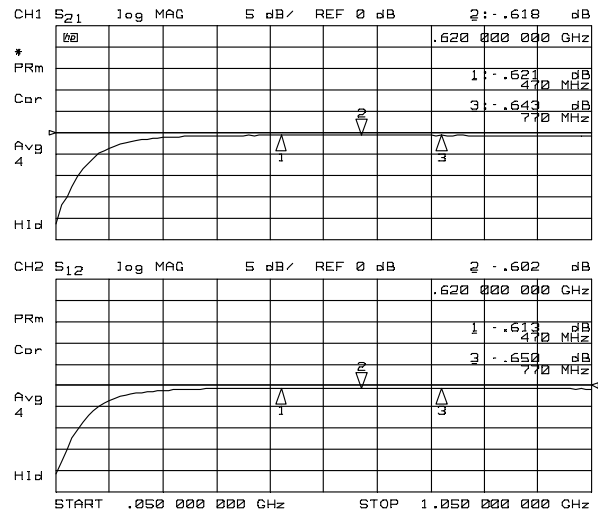

S21, S12

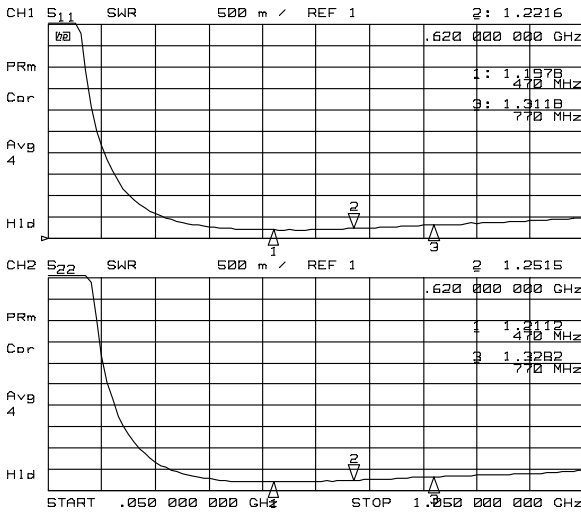

VSWR

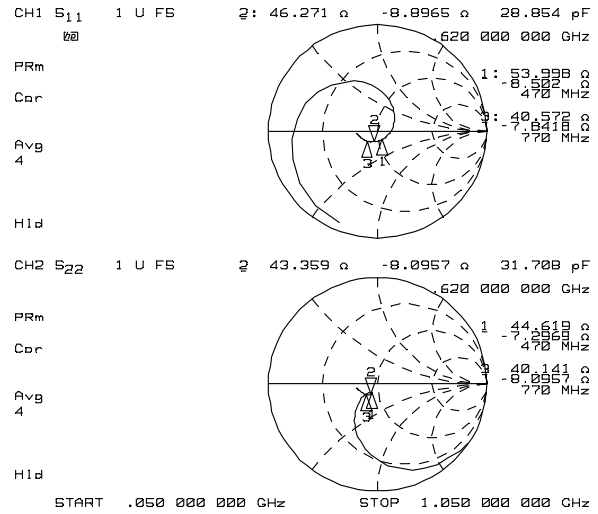

Zin, Zout

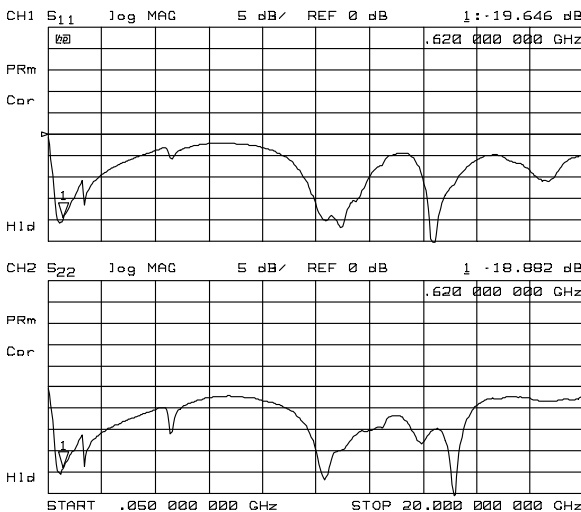

S11, S22 (50MHz~20GHz)

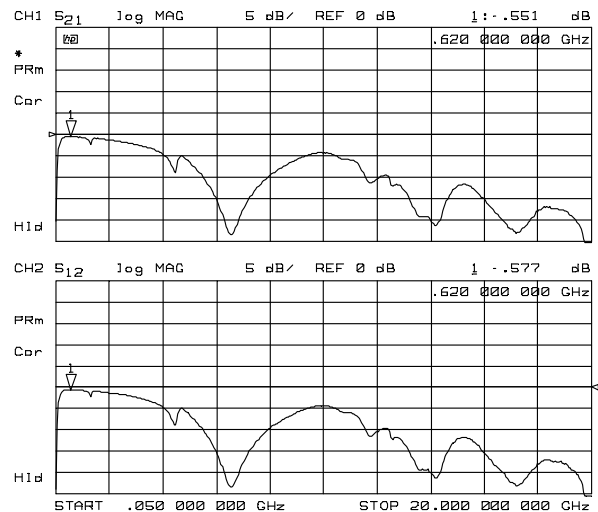

S21, S12 (50MHz~20GHz)

## APPLICATION CIRCUIT

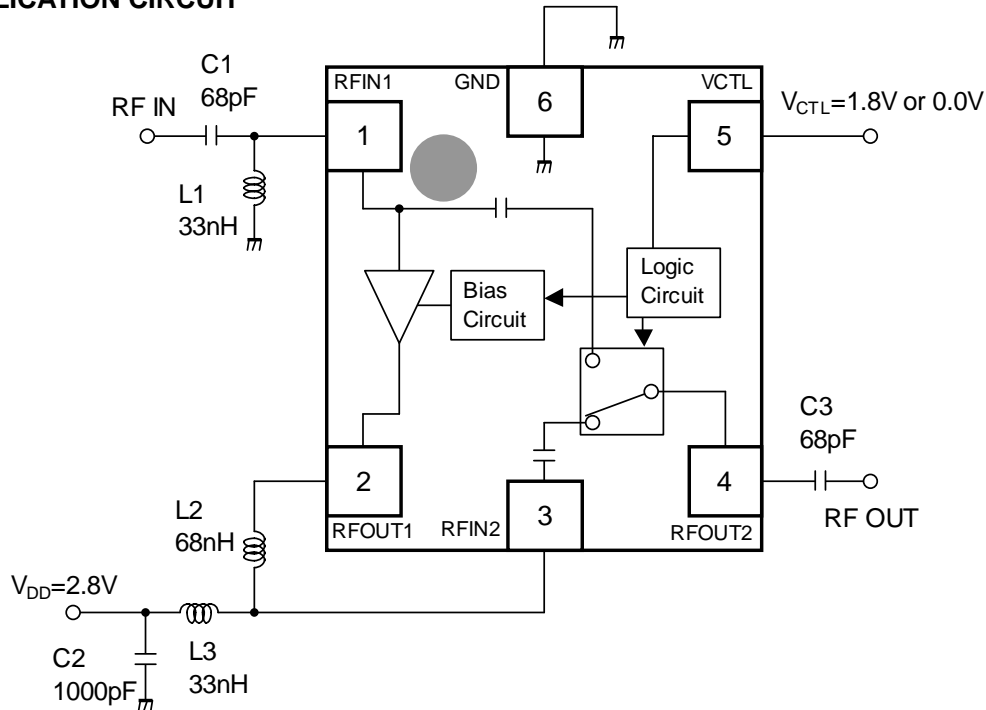

## TEST PCB LAYOUT

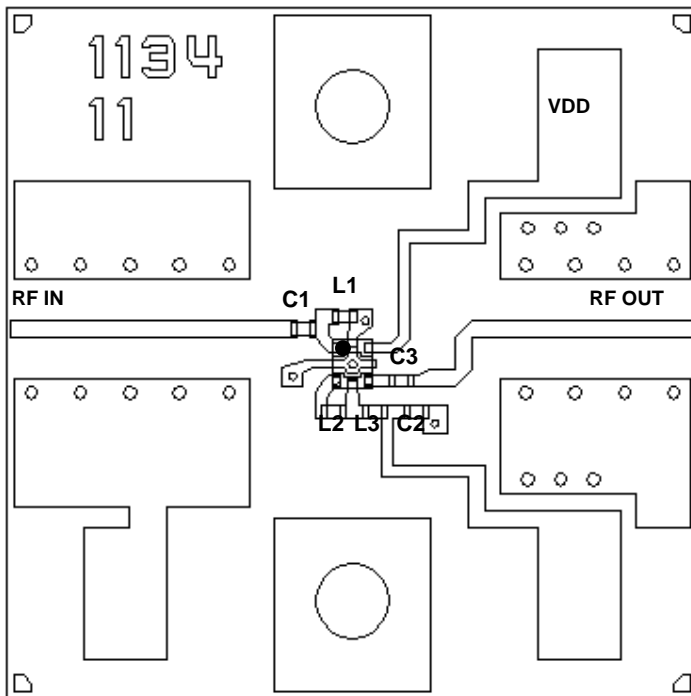

### Parts List

Parts ID	Notes
L1, L3	MURATA (LQP03T series)
L2	TAIYO-YUDEN (HK0603 series)
C1~C3	MURATA (GRM03 series)

PCB (FR-4):  
 t=0.2mm  
 MICROSTRIP LINE  
 WIDTH=0.4mm ( $Z_0=50$  ohm)  
 PCB SIZE=16.8mmx16.8mm

## PRECAUTIONS

- [1] C1 and C3 are DC-Blocking capacitors, and L1 is a DC-feed inductor.
- [2] L2 and L3 formed the output matching circuit.
- [3] C2 is a bypass capacitor.
- [4] Ground terminals (6pin) should be connected with ground plane as close as possible in order to limit ground path induction.
- [5] All external parts are placed as close as possible to the IC.

## MEASUREMENT BLOCK DIAGRAM

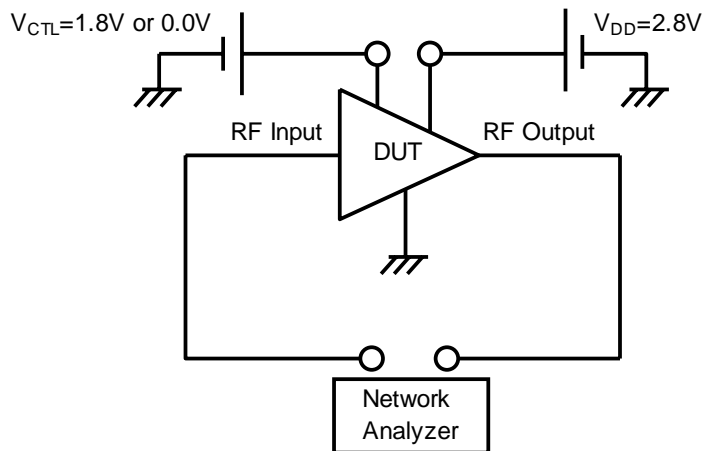

S parameter Measurement Block Diagram

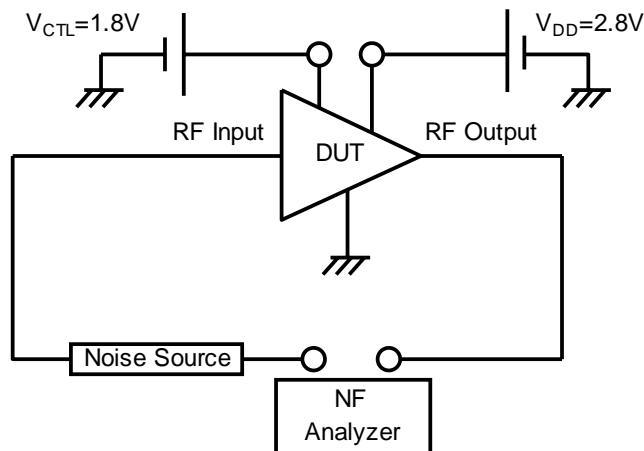

Noise Figure Measurement Block Diagram

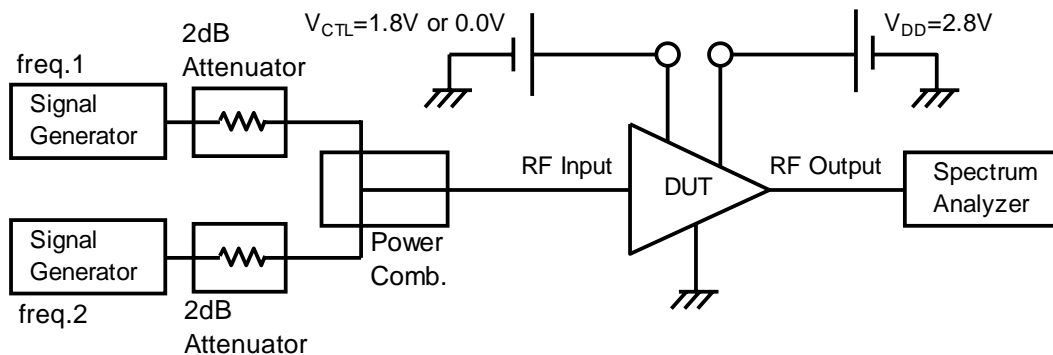

Input IP3 Measurement Block Diagram

## PACKAGE OUTLINE (USB6-A8)

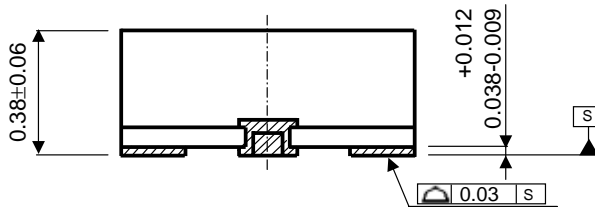
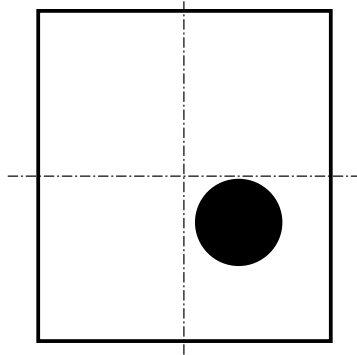

TERMINAL TREAT :Au  
 Substrate :FR5  
 Molding material :Epoxy resin  
 UNIT :mm  
 WEIGHT :1.1mg

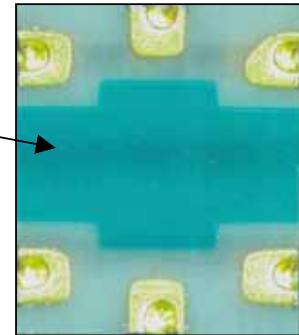
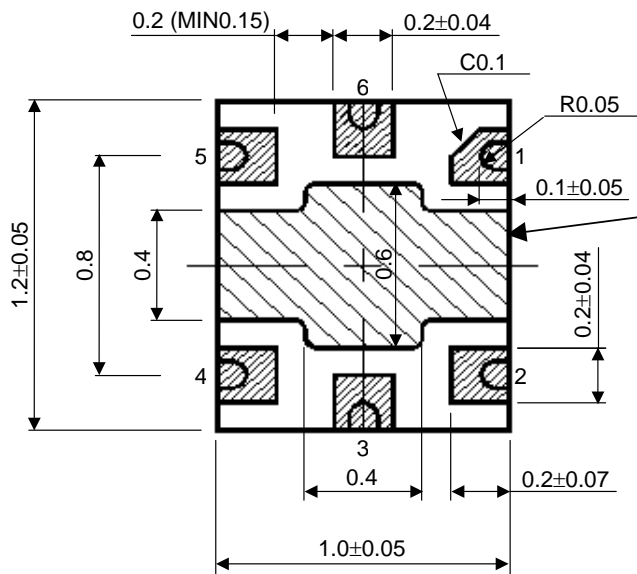

### Cautions on using this product

- This product contains Gallium-Arsenide (GaAs) which is a harmful material.
- Do NOT eat or put into mouth.
  - Do NOT dispose in fire or break up this product.
  - Do NOT chemically make gas or powder with this product.
  - To waste this product, please obey the relating law of your country.

### [CAUTION]

The specifications on this databook are only given for information, without any guarantee as regards either mistakes or omissions. The application circuits in this databook are described only to show representative usages of the product and not intended for the guarantee or permission of any right including the industrial rights.

This product may be damaged with electric static discharge (ESD) or spike voltage. Please handle with care to avoid these damages.