

800MHz Band LNA GaAs MMIC

■ GENERAL DESCRIPTION

NJG1127HB6 is a LNA IC designed for 800MHz band CDMA2000 cellular phone. This IC has the function which bypasses LNA, and high gain mode or low gain mode can be chosen.

High IIP3 and a low noise are achieved at the High gain mode. And low current consumption can be achieved at the low gain mode because LNA enters the state of the standby.

A small and thin package of USB8 is adopted.

■ PACKAGE OUTLINE

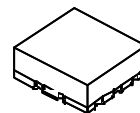

NJG1127HB6

■ FEATURES

- Low voltage operation +2.8V typ.
 - Low control voltage operation +1.85V typ.
- [LNA High Gain Mode]
- High Input IP3 +11dBm typ. @ f=880MHz
 - Low noise figure 1.4dB typ. @ f=880MHz
- [LNA Low Gain Mode]
- Low current consumption 15uA typ.
 - High Input IP3 +19dBm typ. @ f=880MHz
- Small & thin package USB8-B6 (Package size: 1.5mm x1.5mm x 0.55mm typ.)

■ PIN CONFIGURATION

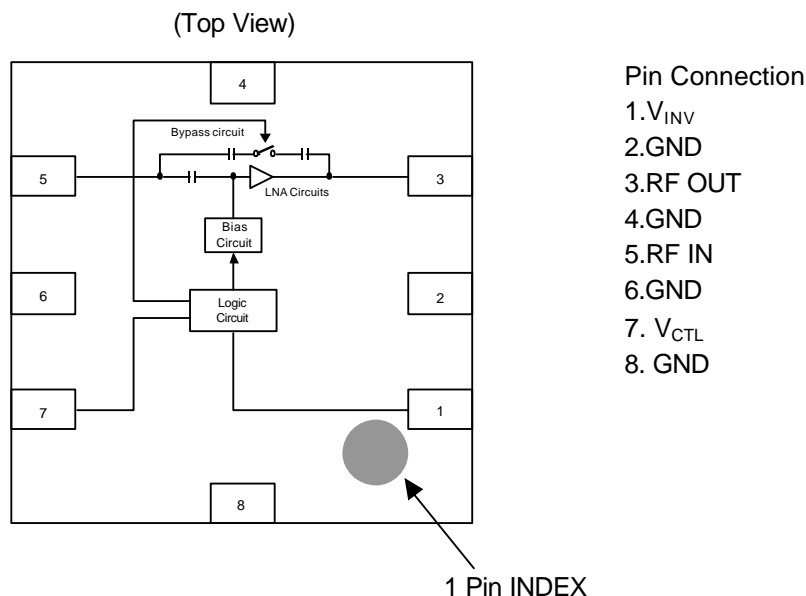

Note: Specifications and description listed in this catalog are subject to change without prior notice.

NJG1127HB6

■ ABSOLUTE MAXIMUM RATINGS

($T_a=+25^{\circ}\text{C}$, $Z_s=Z_l=50\Omega$)

PARAMETERS	SYMBOL	CONDITIONS	RATINGS	UNITS
Supply voltage	V_{DD}		5.0	V
Inverter supply voltage	V_{INV}		5.0	V
Control voltage	V_{CTL}		5.0	V
Input power	P_{in}		+15	dBm
Power dissipation	P_D	on PCB board, $T_{jmax}=150^{\circ}\text{C}$	160	mW
Operating temperature	T_{opr}		-40~+85	$^{\circ}\text{C}$
Storage temperature	T_{stg}		-55~+150	$^{\circ}\text{C}$

■ ELECTRICAL CHARACTERISTICS 1 (DC CHARACTERISTICS)

(General Conditions: $V_{DD}=V_{INV}=2.8\text{V}$, $T_a=+25^{\circ}\text{C}$, $Z_s=Z_l=50\Omega$)

PARAMETERS	SYMBOL	CONDITIONS	MIN	TYP	MAX	UNITS
Operating voltage	V_{DD}		2.65	2.80	2.95	V
Inverter supply voltage	V_{INV}		2.65	2.80	2.95	V
Control voltage (High)	$V_{CTL(H)}$		1.80	1.85	$V_{DD}+0.3$	V
Control voltage (Low)	$V_{CTL(L)}$		0	0	0.3	V
Operating current1 (LNA High Gain Mode)	I_{DD1}	RF OFF, $V_{CTL}=1.85\text{V}$	-	10.0	16.0	mA
Operating current2 (LNA Low Gain Mode)	I_{DD2}	RFOFF, $V_{CTL}=0\text{V}$	-	1	5	μA
Inverter current1 (LNA High Gain Mode)	I_{INV1}	RF OFF, $V_{CTL}=1.85\text{V}$	-	150	240	μA
Inverter current2 (LNA Low Gain Mode)	I_{INV2}	RF OFF, $V_{CTL}=0\text{V}$	-	15	40	μA
Control current	I_{CTL}	RF OFF, $V_{CTL}=1.85\text{V}$	-	5	15	μA

■ ELECTRICAL CHARACTERISTICS 2 (LNA High Gain Mode)

(General Conditions: $V_{DD}=V_{INV}=2.8V$, $V_{CTL}=1.85V$, $f_{RF}=880MHz$, $T_a=+25^{\circ}C$, $Z_s=Z_l=50\Omega$)

PARAMETERS	SYMBOL	CONDITIONS	MIN	TYP	MAX	UNITS
Small signal gain1	Gain1		13.5	15.0	17.0	dB
Noise figure1	NF1	Exclude PCB & connector losses (IN: 0.04dB)	-	1.4	1.8	dB
1dB gain compression output power1	P-1dB_1		+4	+9	-	dBm
3rd order Input Intercept Point1	IIP3_1	$f1=f_{RF}$, $f2=f_{RF}+100kHz$, $P_{in}=-25dBm$	+8	+11	-	dBm
RF IN VSWR1	VSWR _{i_1}		-	1.5	2.0	
RF OUT VSWR1	VSWR _{o_1}		-	1.5	2.0	

■ ELECTRICAL CHARACTERISTICS 2 (LNA Low Gain Mode)

(General Conditions: $V_{DD}=V_{INV}=2.8V$, $V_{CTL}=0V$, $f_{RF}=880MHz$, $T_a=+25^{\circ}C$, $Z_s=Z_l=50\Omega$)

PARAMETERS	SYMBOL	CONDITIONS	MIN	TYP	MAX	UNITS
Small signal gain2	Gain2		-4.0	-2.5	0	dB
Noise figure2	NF2	Exclude PCB & connector losses (IN: 0.04dB)	-	2.5	5.0	dB
1dB gain compression output power2	P-1dB_2		+1	+8	-	dBm
3rd order Input Intercept Point2	IIP3_2	$f1=f_{RF}$, $f2=f_{RF}+100kHz$, $P_{in}=-12dBm$	+15	+19	-	dBm
RF IN VSWR2	VSWR _{i_2}		-	2.3	2.7	
RF OUT VSWR2	VSWR _{o_2}		-	1.8	2.1	

NJG1127HB6

■ TERMINAL INFORMATION

No.	SYMBOL	DESCRIPTION
1	VINV	Supply voltage terminal for internal logic circuit (inverter). Please place a bypass capacitor between this and GND for avoiding RF noise from outside.
2	GND	Ground terminal.
3	RFOUT	RF signal comes out from this terminal, and goes through an external matching circuit connected to this. Inductor L3 as shown in the application circuit is a part of an external matching circuit, and also provide DC power to LNA. Capacitor C2 as shown in the application circuit is a bypass capacitor.
4	GND	Ground terminal.
5	RFIN	RF input terminal. The RF signal is input through external matching circuit connected to this terminal. A DC blocking capacitor is not required.
6	GND	Ground terminal.
7	VCTL	Control port. A logic control signal is required to select High or Low gain mode of LNA. This terminal is set to more than +1.5V of logical high level for High gain mode of LNA, and set to 0~+0.3V of logical low level for Low gain mode.
8	GND	Ground terminal.

CAUTION

- 1) Ground terminal (No.2, 4, 6, 8) should be connected to the ground plane as close as possible for excellent RF performance, because distance to GND makes parasitic inductance.

■ TRUTH TABLE

"H"= $V_{CTL}(H)$, "L"= $V_{CTL}(L)$

V_{CTL}	Gain Mode	LNA
L	Low	bypass
H	High	pass

■ ELECTRICAL CHARACTERISTICS (LNA High Gain Mode)

(General Conditions: $T_a=+25^\circ\text{C}$, $V_{DD}=V_{INV}=2.8\text{V}$, $V_{CTL}=1.85\text{V}$, $Z_S=Z_L=50\Omega$)

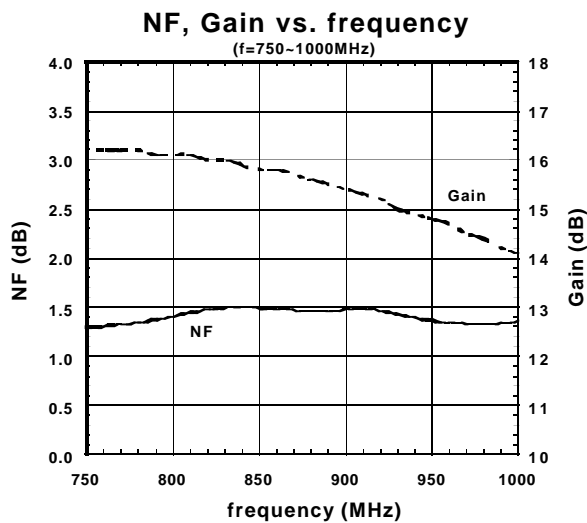
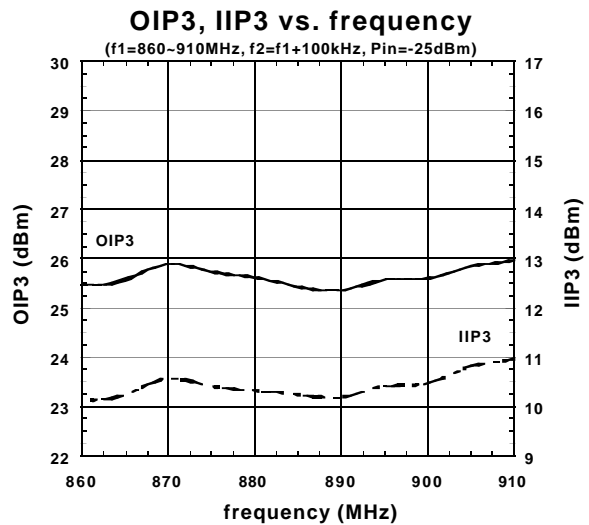
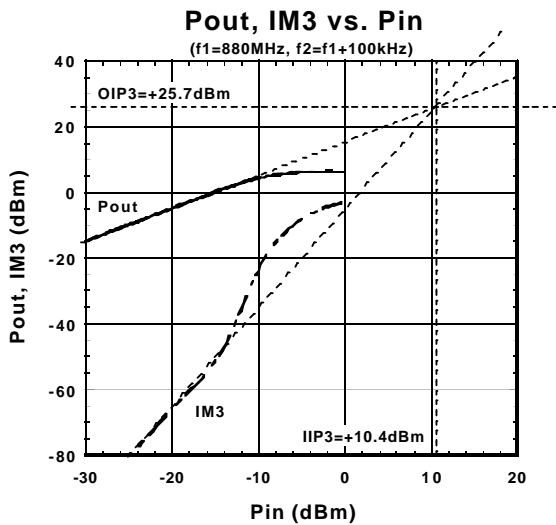
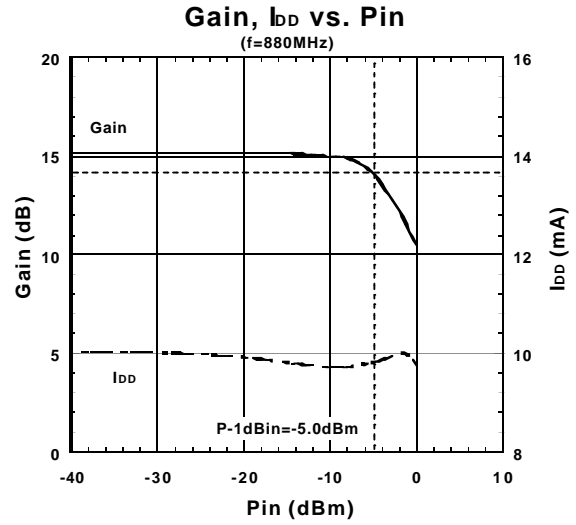
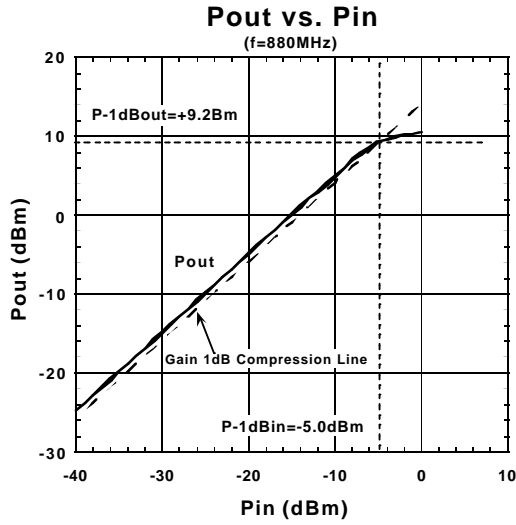

NJG1127HB6

ELECTRICAL CHARACTERISTICS (LNA High Gain Mode)

(General Conditions: $T_a=+25^\circ\text{C}$, $V_{DD}=V_{INV}=2.8\text{V}$, $V_{CTL}=1.85\text{V}$, $Z_S=Z_L=50\Omega$)

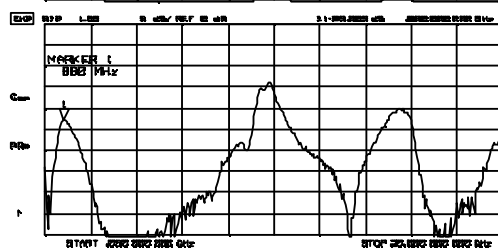
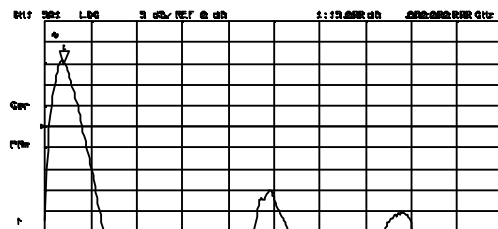
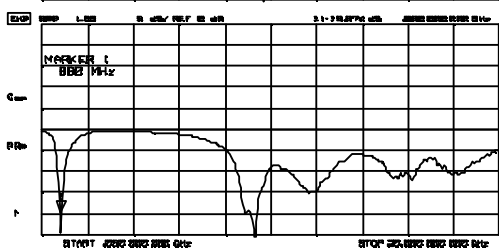
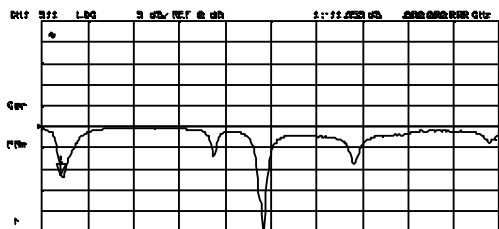
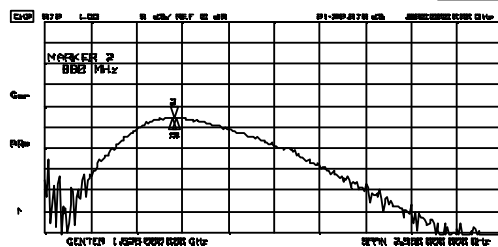
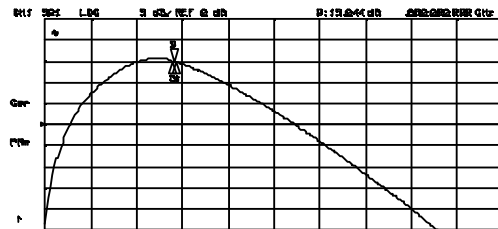
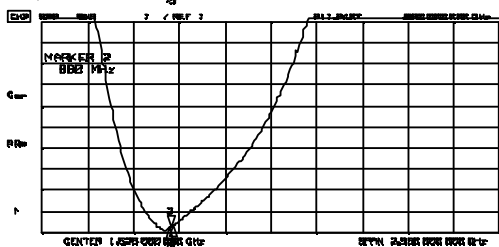
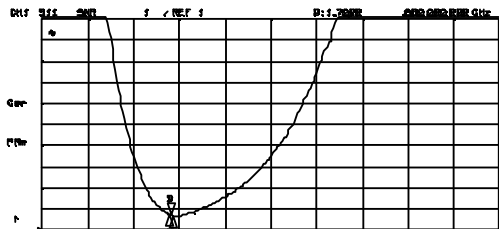
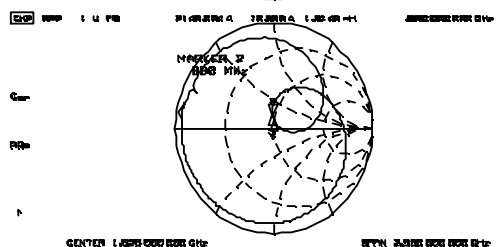
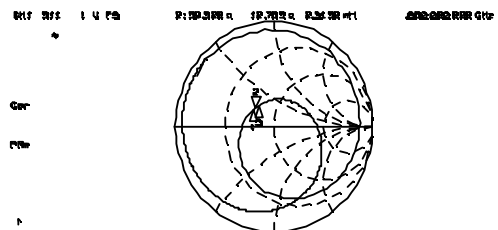
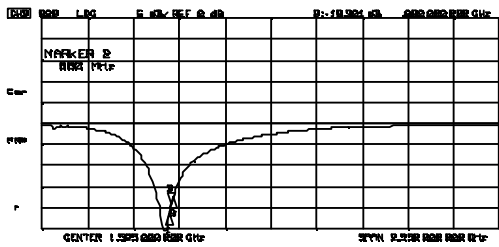
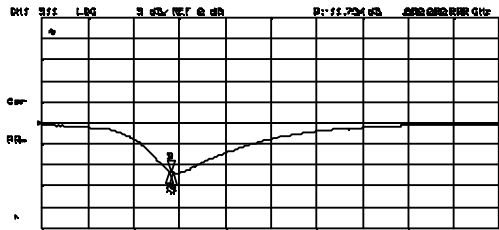

■ ELECTRICAL CHARACTERISTICS (LNA High Gain Mode)

(General Conditions: $T_a=+25^\circ\text{C}$, $V_{DD}=V_{INV}=2.8\text{V}$, $V_{CTL}=1.85\text{V}$, $Z_S=Z_L=50\Omega$)

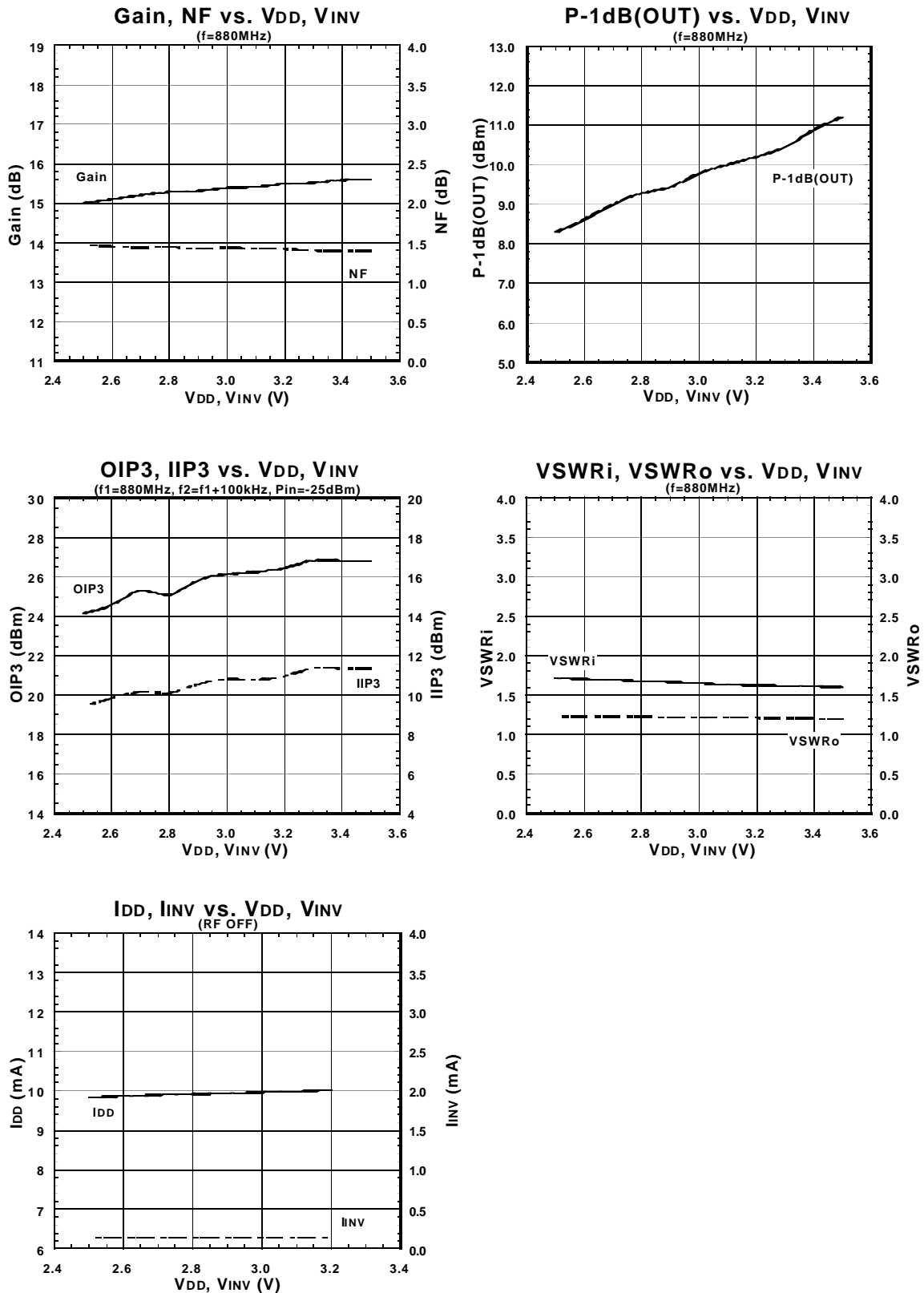

NJG1127HB6

■ ELECTRICAL CHARACTERISTICS (LNA High Gain Mode)

(General Conditions: $T_a=+25^\circ\text{C}$, $V_{DD}=V_{INV}=2.8\text{V}$, $V_{CTL}=1.85\text{V}$, $Z_s=Z_l=50\Omega$)

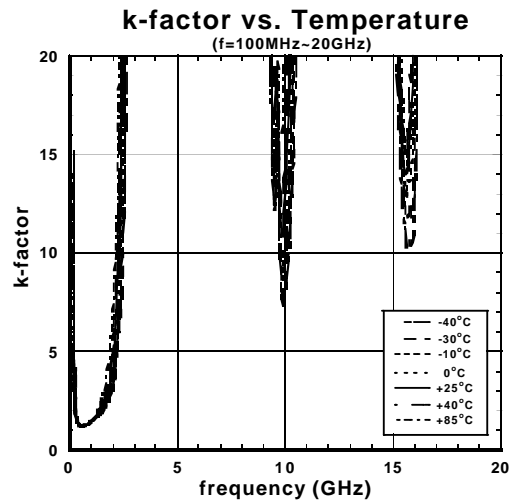
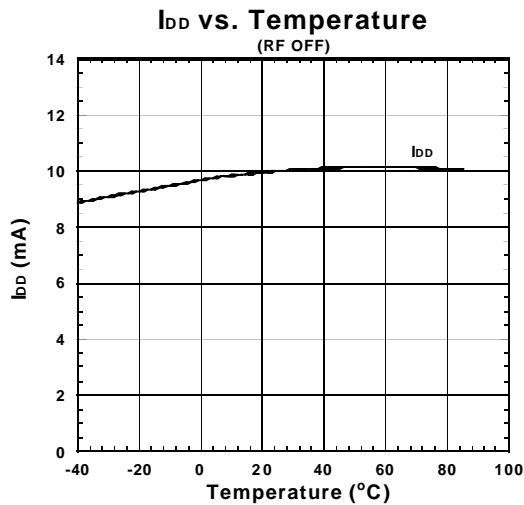
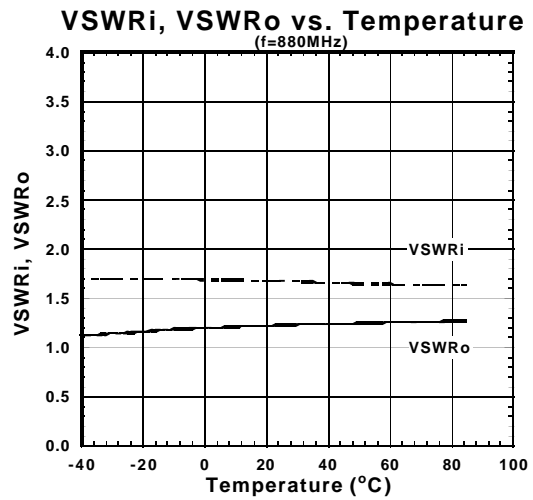
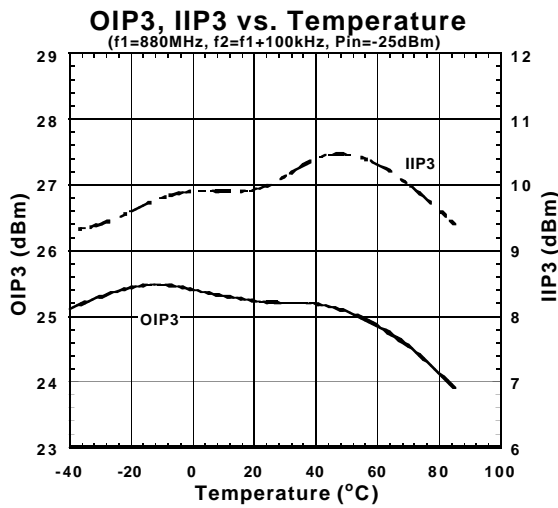
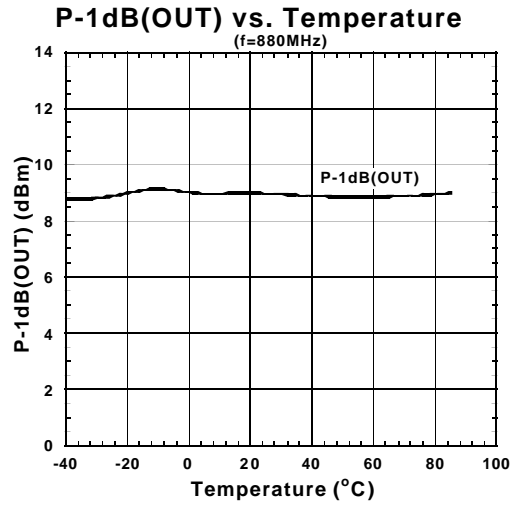
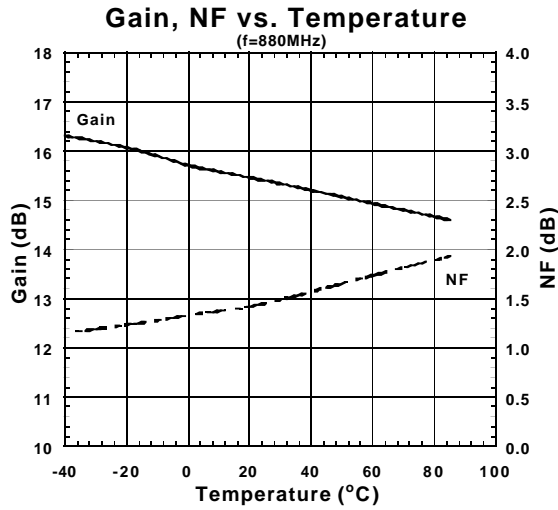

■ ELECTRICAL CHARACTERISTICS (LNA Low Gain Mode)

(General Conditions: $T_a=+25^\circ\text{C}$, $V_{DD}=V_{INV}=2.8\text{V}$, $V_{CTL}=0\text{V}$, $Z_s=Z_l=50\Omega$)

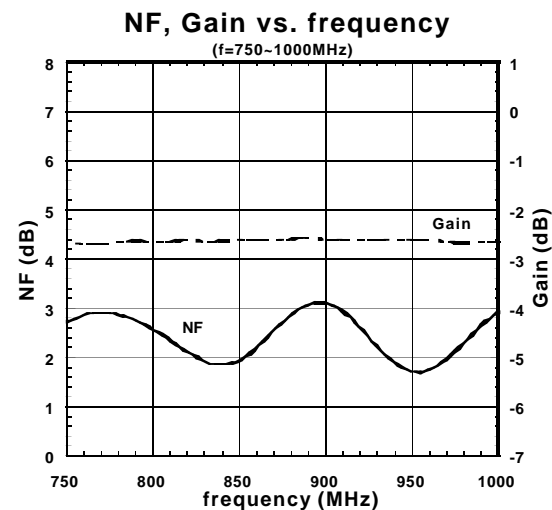
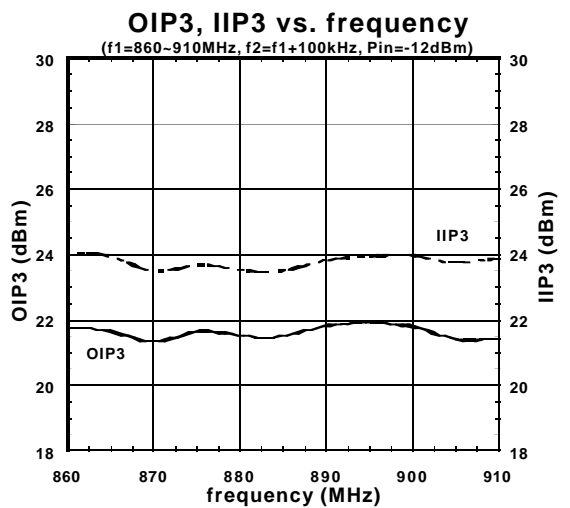
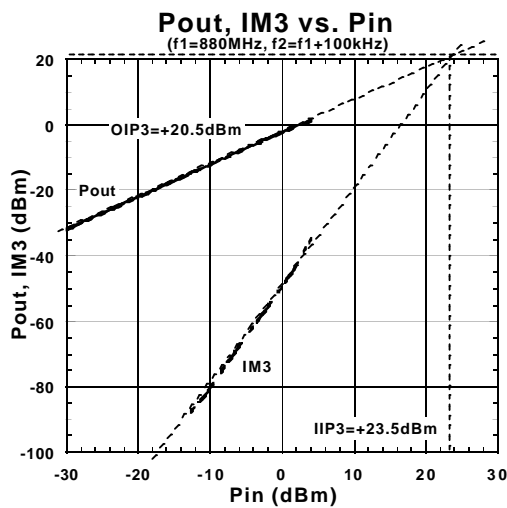
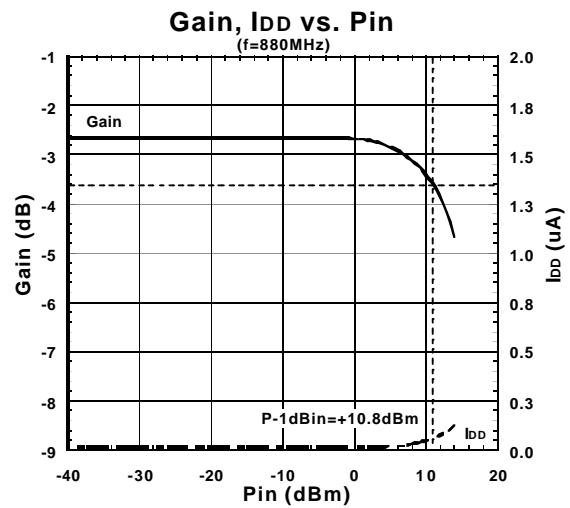
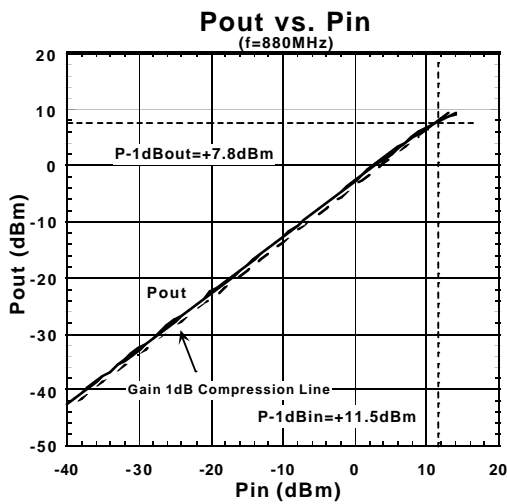

NJG1127HB6

ELECTRICAL CHARACTERISTICS (LNA Low Gain Mode)

(General Conditions: $T_a=+25^\circ\text{C}$, $V_{DD}=V_{INV}=2.8\text{V}$, $V_{CTL}=0\text{V}$, $Z_s=Z_l=50\Omega$)

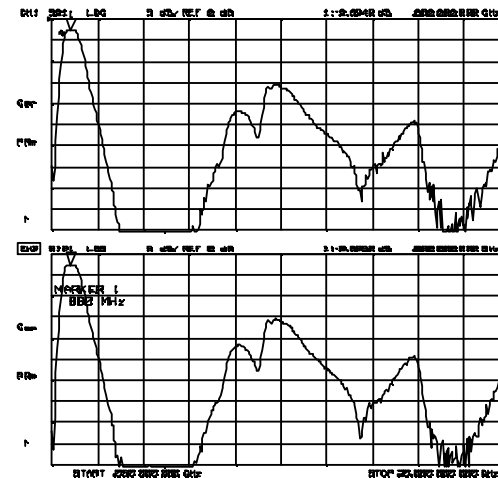
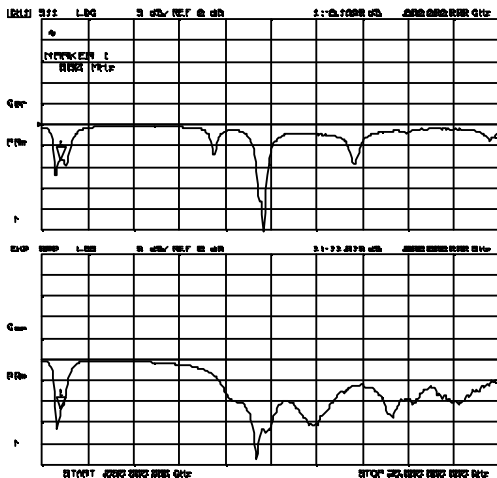
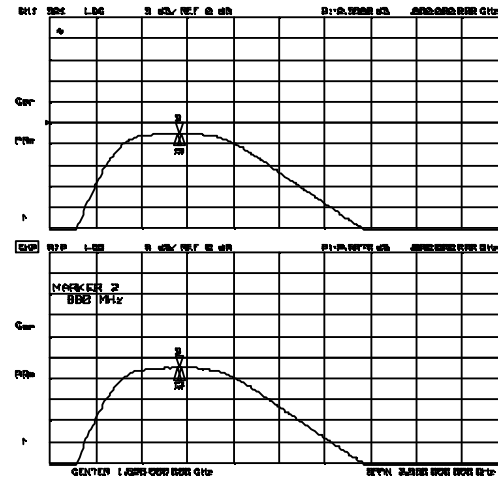
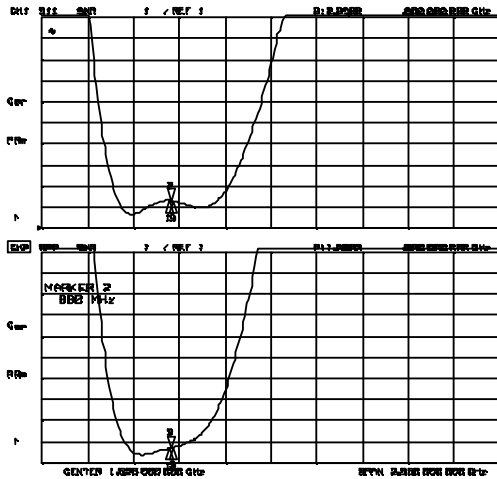
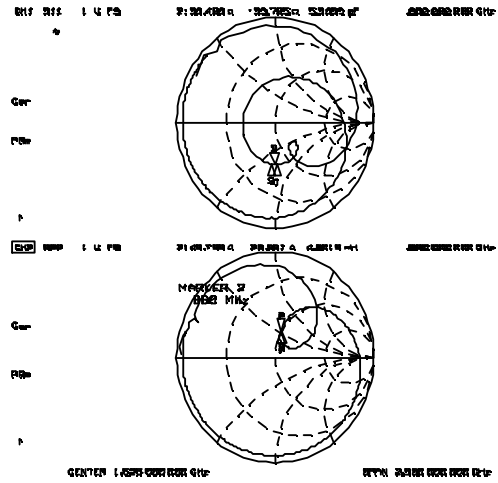
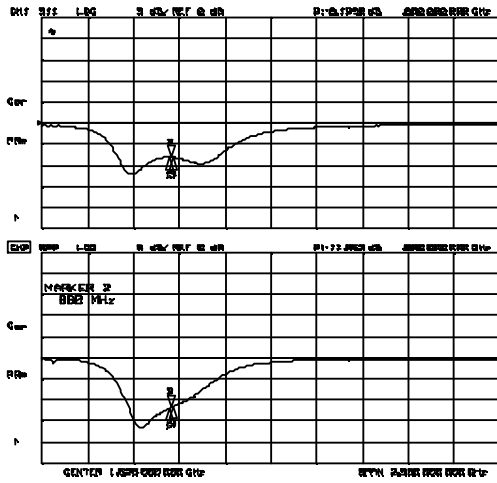

■ ELECTRICAL CHARACTERISTICS (LNA Low Gain Mode)

(General Conditions: $T_a=+25^\circ\text{C}$, $V_{DD}=V_{INV}=2.8\text{V}$, $V_{CTL}=0\text{V}$, $Z_s=Z_l=50\Omega$)

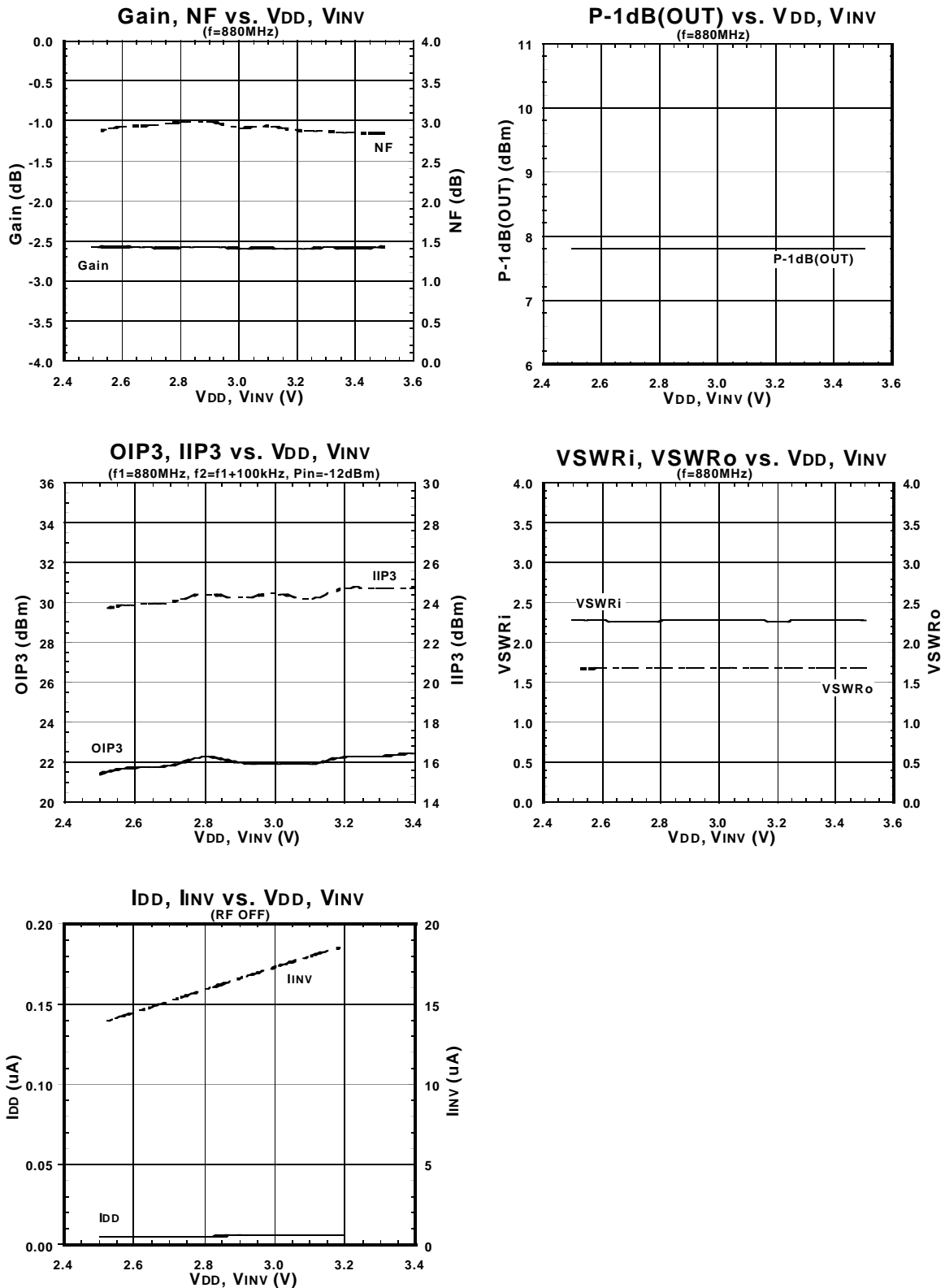

NJG1127HB6

■ ELECTRICAL CHARACTERISTICS (LNA Low Gain Mode)

(General Conditions: $T_a=+25^\circ\text{C}$, $V_{DD}=V_{INV}=2.8\text{V}$, $V_{CTL}=0\text{V}$, $Z_s=Z_l=50\Omega$)

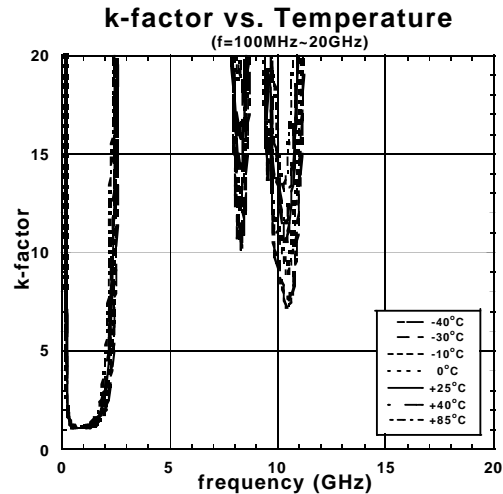
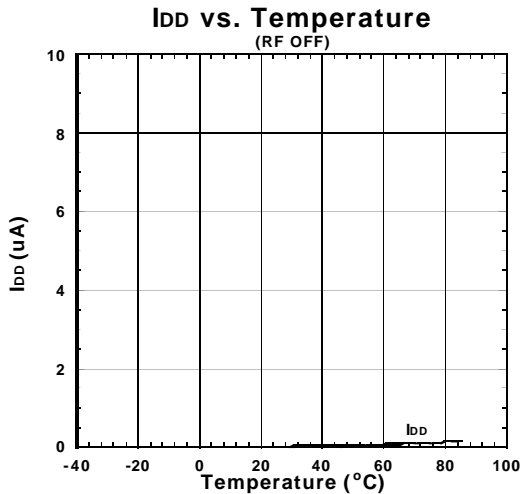
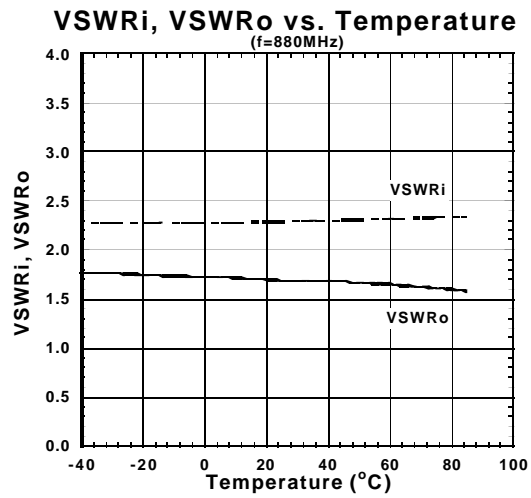
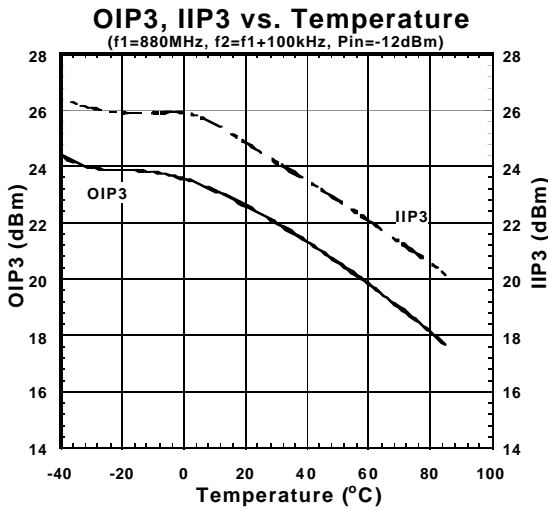
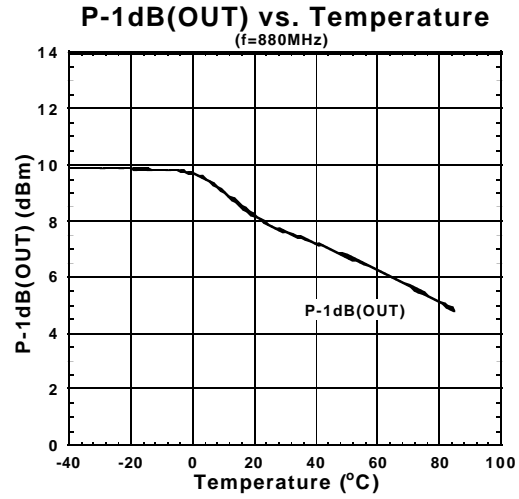
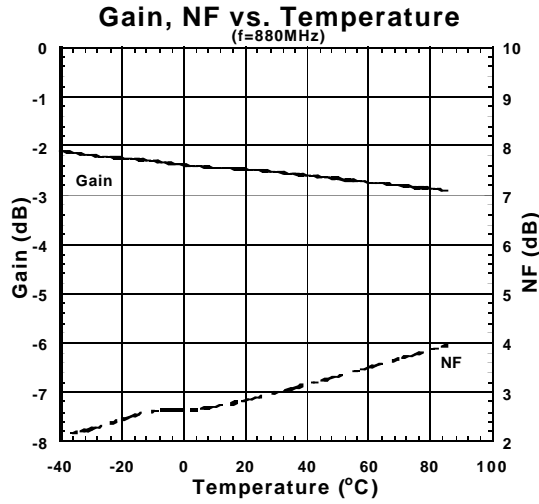

APPLICATION CIRCUIT

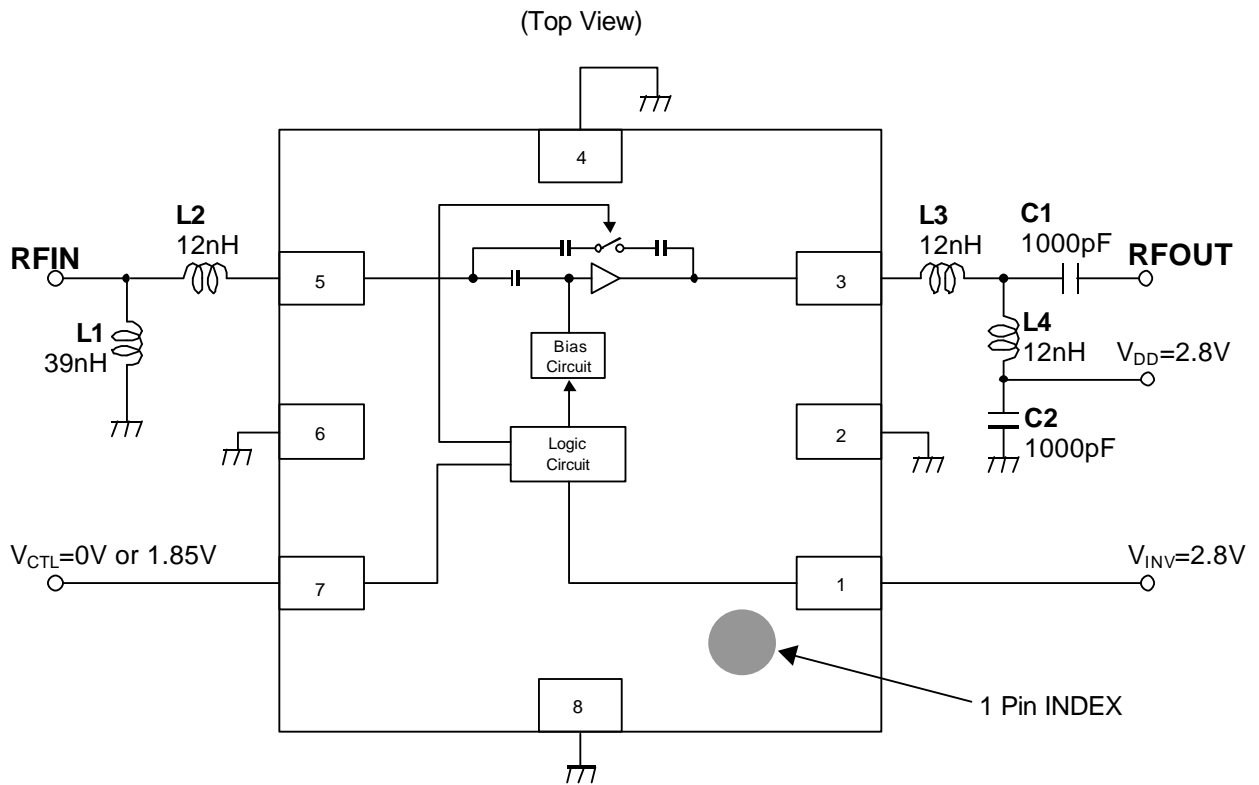

TEST PCB LAYOUT

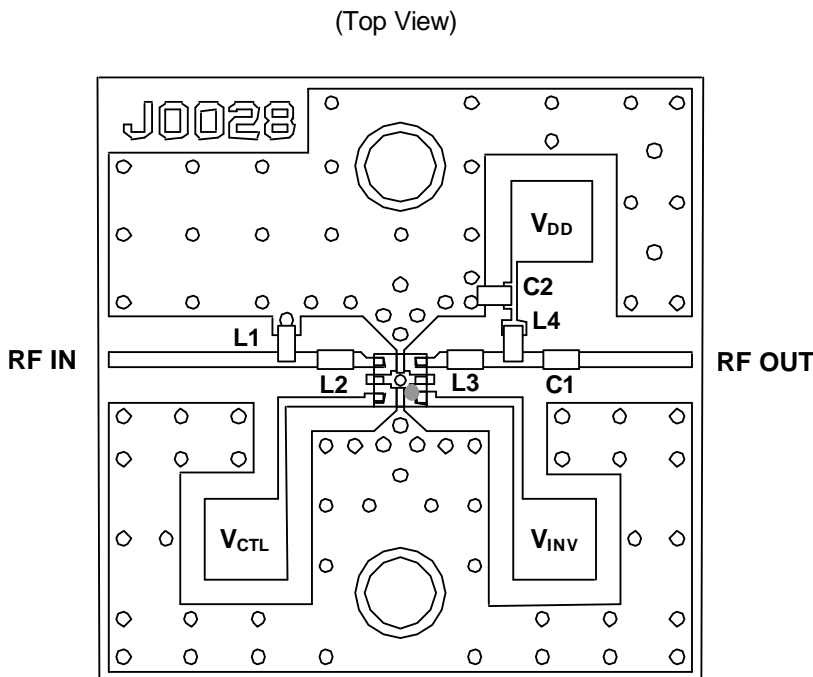

Parts List

Parts ID	Notes
L1~L4	TAIYO-YUDEN (HK1005 series)
C1,C2	MURATA (GRM15 series)

PCB (FR-4) :

t=0.2mm

MICROSTRIP LINE WIDTH
=0.4mm ($Z_0=50\Omega$)

PCB SIZE=17.0mm X 17.0mm

NJG1127HB6

■ PACKAGE OUTLINE (USB8-B6)

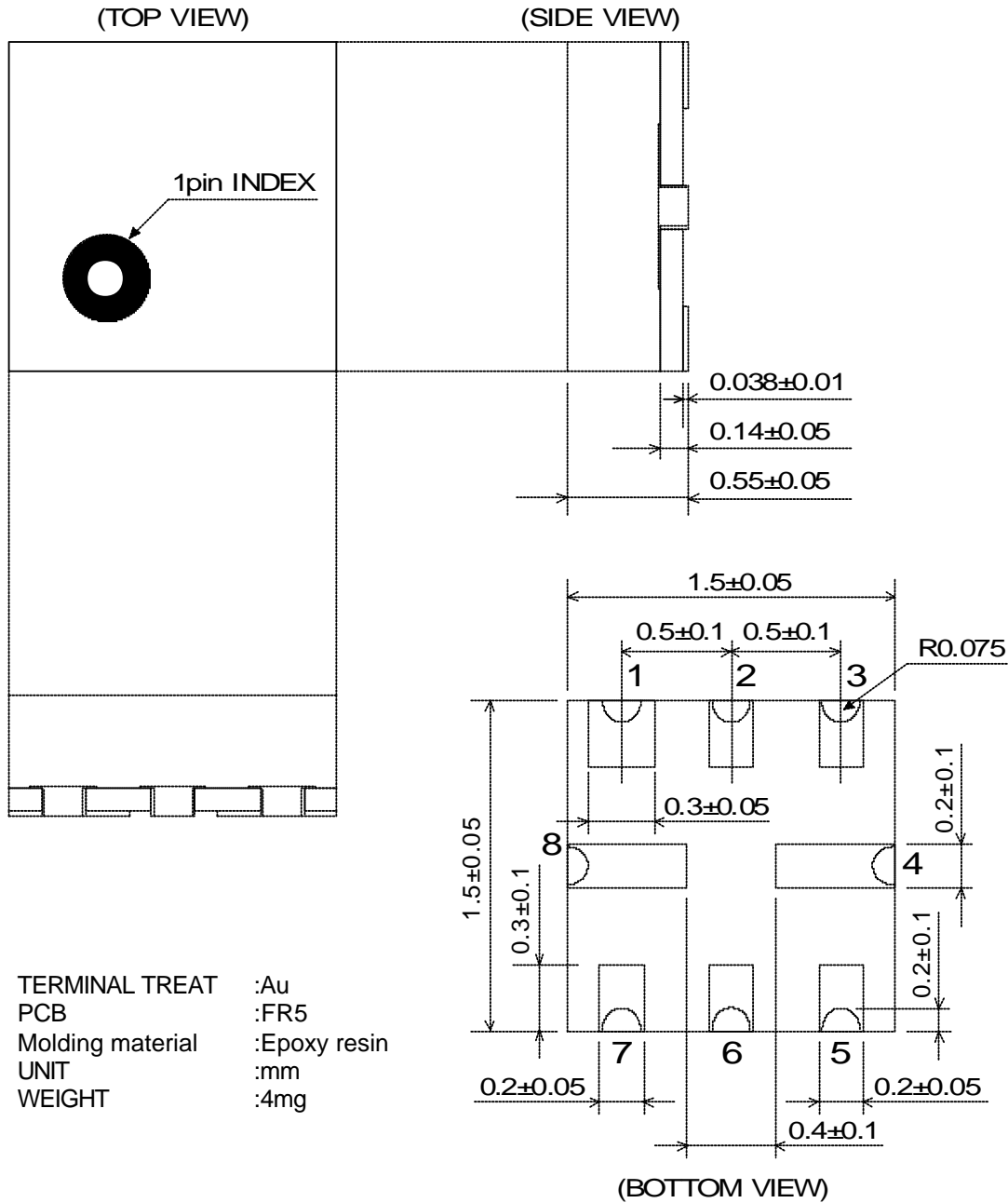

Cautions on using this product

This product contains Gallium-Arsenide (GaAs) which is a harmful material.

- Do NOT eat or put into mouth.
- Do NOT dispose in fire or break up this product.
- Do NOT chemically make gas or powder with this product.
- To waste this product, please obey the relating law of your country.

[CAUTION]

The specifications on this databook are only given for information, without any guarantee as regards either mistakes or omissions. The application circuits in this databook are described only to show representative usages of the product and not intended for the guarantee or permission of any right including the industrial rights.

This product may be damaged with electric static discharge (ESD) or spike voltage. Please handle with care to avoid these damages.