

## W-CDMA Dual LNA GaAs MMIC

### GENERAL DESCRIPTION

The NJG1122PB4 is a Dual band LNA IC designed for W-CDMA cellular phone of 2.1GHz and 800MHz band.

This IC has a LNA pass-through function to select high gain mode or low gain mode.

An ultra small and ultra thin package of FFP12-B4 is adopted.

### PACKAGE OUTLINE



NJG1122PB4

### FEATURES

- Low voltage operation +2.7V
  - Low CTL voltage operation +1.85V
  - Low current consumption
    - 2.4mA typ. @2.1GHz band (High Gain Mode)
    - 2.0mA typ. @800MHz band (High Gain Mode)
    - 4uA typ. @800MHz / 2.1GHz band (Low Gain Mode)
  - Small package FFP12-B4 (Package size: 2.0 x 2.0 x 0.65mm typ)
- [High gain mode]
- High gain
    - 14.5dB typ. @ $f_{RF}=2140\text{MHz}$  16.0dB typ. @ $f_{RF}=885\text{MHz}$
    - 1.7dB typ. @ $f_{RF}=2140\text{MHz}$
    - 1.45dB typ. @ $f_{RF}=885\text{MHz}$
  - High Input IP3
    - 3.5dBm typ. @  $f_{RF}=2140.0+2140.1\text{MHz}$ , Pin=-36dBm
    - 3.5dBm typ. @  $f_{RF}=885.0+885.1\text{MHz}$ , Pin=-36dBm
- [Low gain mode]
- Gain
    - 4.0dB typ. @ $f_{RF}=2140\text{MHz}$
    - 4.5dB typ. @ $f_{RF}=885\text{MHz}$
  - Low noise figure
    - 4.0dB typ. @ $f_{RF}=2140\text{MHz}$
    - 4.5dB typ. @ $f_{RF}=885\text{MHz}$
  - High Input IP3
    - +2.5dBm typ. @ $f_{RF}=2140.0+2140.1\text{MHz}$ , Pin=-20dBm
    - +2.0dBm typ. @ $f_{RF}=885.0+885.1\text{MHz}$ , Pin=-20dBm

### PIN CONFIGURATION

(Top View)

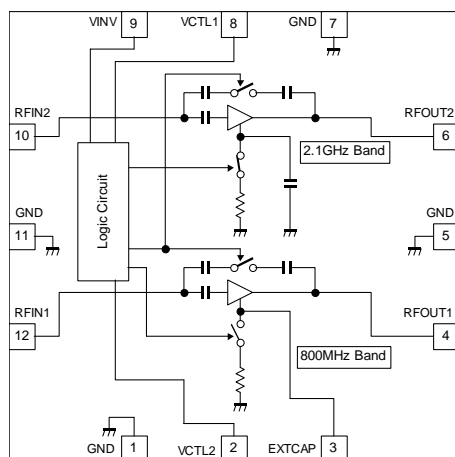

Pin Connection

1. GND
2. VCTL2
3. EXTCAP
4. RFOUT1 (800MHz band)
5. GND
6. RFOUT2 (2.1GHz band)
7. GND
8. VCTL1
9. VINV
10. RFIN2 (2.1GHz band)
11. GND
12. RFIN1 (800MHz band)

Note: Specifications and description listed in this catalog are subject to change without prior notice.

# NJG1122PB4

## ■ABSOLUTE MAXIMUM RATINGS

( $T_a=+25^{\circ}\text{C}$ ,  $Z_s=Z_f=50\Omega$ )

PARAMETERS	SYMBOL	CONDITIONS	RATINGS	UNITS
Operating voltage	$V_{DD}$		5.0	V
Inverter supply voltage	$V_{INV}$		5.0	V
Control voltage	$V_{CTL}$		5.0	V
Input power	$P_{in}$	$V_{DD}=2.7V$	+15	dBm
Power dissipation	$P_D$		300	mW
Operating temperature	$T_{opr}$		-40~+85	$^{\circ}\text{C}$
Storage temperature	$T_{stg}$		-55~+125	$^{\circ}\text{C}$

## ■ELECTRICAL CHARACTERISTICS 1 (DC)

( $V_{DD}=V_{INV}=2.7V$ ,  $T_a=+25^{\circ}\text{C}$ ,  $Z_s=Z_f=50\Omega$ )

PARAMETERS	SYMBOL	CONDITIONS	MIN	TYP	MAX	UNITS
Operating voltage	$V_{DD}$		2.5	2.7	4.5	V
Inverter supply voltage	$V_{INV}$		2.5	2.7	4.5	V
Control voltage1 (High)	$V_{CTL1(H)}$		1.44	1.85	$V_{INV}+0.3$	V
Control voltage1 (Low)	$V_{CTL1(L)}$		0	0	0.8	V
Control voltage 2 (High)	$V_{CTL2(H)}$		1.44	1.85	$V_{INV}+0.3$	V
Control voltage 2 (Low)	$V_{CTL2(L)}$		0	0	0.8	V
Operating current1 800MHz[High gain mode]	$I_{DD1}$	$V_{CTL1}=2.7V$ , $V_{CTL2}=1.85V$	-	2.4	2.9	mA
Operating current2 2.1GHz[High gain mode]	$I_{DD2}$	$V_{CTL1}=0V$ , $V_{CTL2}=1.85V$	-	2.0	2.4	mA
Operating current 3 800M/2.1GHz[Low gain mode]	$I_{DD3}$	$V_{CTL1}=0$ or $1.85V$ , $V_{CTL2}=0V$	-	4	13	$\mu\text{A}$
Inverter current1	$I_{INV1}$	RF OFF, $V_{CTL}=1.85V$	-	160	250	$\mu\text{A}$
Inverter current2	$I_{INV2}$	RF OFF, $V_{CTL}=0V$	-	210	330	$\mu\text{A}$
Control current 1	$I_{CTL1}$	$V_{CTL1}=1.85V$	-	14	35	$\mu\text{A}$
Control current 2	$I_{CTL2}$	$V_{CTL2}=1.85V$	-	14	35	$\mu\text{A}$

## ■ELECTRICAL CHARACTERISTICS 2 (2.1GHz band High Gain mode)

( $V_{DD}=V_{INV}=2.7V$ ,  $V_{CTL1}=0V$ ,  $V_{CTL2}=1.85V$ ,  $f_{RF}=2140MHz$ ,  $T_a=+25^{\circ}C$ ,  $Z_s=Z_f=50\Omega$ , TEST CIRCUIT)

PARAMETERS	SYMBOL	CONDITIONS	MIN	TYP	MAX	UNITS
Small signal gain1	Gain1		13.0	14.5	16.0	dB
Noise figure1	NF1		-	1.7	2.0	dB
Pin at 1dB gain compression point1	$P_{-1dB(1)}$		-16.0	-14.0	-	dBm
Input 3rd order intercept point	IIP3_1	$f1=f_{RF}$ , $f2=f_{RF}+100kHz$ , $Pin=-36dBm$	-6.0	-3.5	-	dBm
RF Input VSWR1	$VSWR_{i1}$		-	1.7	2.2	
RF Output VSWR1	$VSWR_{o1}$		-	1.9	2.5	

## ■ELECTRICAL CHARACTERISTICS 3 (2.1GHz band Low Gain mode)

( $V_{DD}=V_{INV}=2.7V$ ,  $V_{CTL1}=V_{CTL2}=0V$ ,  $f_{RF}=2140MHz$ ,  $T_a=+25^{\circ}C$ ,  $Z_s=Z_f=50\Omega$ , TEST CIRCUIT)

PARAMETERS	SYMBOL	CONDITIONS	MIN	TYP	MAX	UNITS
Small signal gain2	Gain2		-6.0	-4.0	-2.5	dB
Noise figure2	NF2		-	4.0	6.0	dB
Pin at 1dB gain compression point2	$P_{-1dB(2)}$		+5.0	+11.0	-	dBm
Input 3rd order intercept point2	IIP3_2	$F1=f_{RF}$ , $f2=f_{RF}+100kHz$ , $Pin=-36dBm$	0	+2.5	-	dBm
RF Input VSWR2	$VSWR_{i2}$		-	2.0	2.5	
RF Output VSWR2	$VSWR_{o2}$		-	1.6	2.0	

# NJG1122PB4

## ■ELECTRICAL CHARACTERISTICS 4 (800MHz band High Gain mode)

( $V_{DD}=V_{INV}=2.7V$ ,  $V_{CTL1}=V_{CTL2}=1.85V$ ,  $f_{RF}=885MHz$ ,  $T_a=+25^{\circ}C$ ,  $Z_s=Z_f=50\Omega$ , TEST CIRCUIT)

PARAMETERS	SYMBOL	CONDITIONS	MIN	TYP	MAX	UNITS
Small signal gain1	Gain3		14.5	16.0	17.5	dB
Noise figure1	NF3		-	1.45	1.75	dB
Pin at 1dB gain compression point1	$P_{-1dB(3)}$		-17.0	-15.0	-	dBm
Input 3rd order intercept point	IIP3_3	$f1=f_{RF}$ , $f2=f_{RF}+100kHz$ , $P_{in}=-36dBm$	-6.0	-3.5	-	dBm
RF Input VSWR1	$VSWR_{i,3}$		-	1.6	2.1	
RF Output VSWR1	$VSWR_{o,3}$		-	1.7	2.3	

## ■ELECTRICAL CHARACTERISTICS 5 (800MHz band Low Gain mode)

( $V_{DD}=V_{INV}=2.7V$ ,  $V_{CTL1}=1.85V$ ,  $V_{CTL2}=0V$ ,  $f_{RF}=885MHz$ ,  $T_a=+25^{\circ}C$ ,  $Z_s=Z_f=50\Omega$ , TEST CIRCUIT)

PARAMETERS	SYMBOL	CONDITIONS	MIN	TYP	MAX	UNITS
Small signal gain2	Gain4		-6.0	-4.0	-3.0	dB
Noise figure2	NF4		-	4.5	6.5	dB
Pin at 1dB gain compression point2	$P_{-1dB(4)}$		+4.0	+9.0	-	dBm
Input 3rd order intercept point2	IIP3_4	$F1=f_{RF}$ , $f2=f_{RF}+100kHz$ , $P_{in}=-36dBm$	1.5	+2.0	-	dBm
RF Input VSWR2	$VSWR_{i,4}$		-	1.7	2.3	
RF Output VSWR2	$VSWR_{o,4}$		-	1.6	2.1	

## ■ TERMINAL INFORMATION

No.	SYMBOL	DESCRIPTION
1	GND	Ground terminal. (0V)
2	VCTL2	Control voltage supply terminal. The high level voltage of this terminal selects High Gain Mode. The low level voltage of this terminal selects Low Gain Mode.
3	EXTCAP	An external bypass capacitor is required. (Please refer to TEST CIRCUIT.)
4	RFOUT1	Output terminal of 800MHz band. This terminal is also the power supply terminal of the LNA, please use inductor (L3) to connect power supply.
5	GND	Ground terminal. (0V)
6	RFOUT2	Output terminal of 2.1GHz band. This terminal is also the power supply terminal of the LNA, please use inductor (L7) to connect power supply.
7	GND	Ground terminal. (0V)
8	VCTL1	Control voltage supply terminal. The high level voltage of this terminal selects 800MHz.band. The low level voltage of this terminal selects 2.1GHz band.
9	VINV	Inverter voltage supplies terminal.
10	RFIN2	RF input terminal of 2.1GHz band. The RF signal is input through external matching circuit connected to this terminal. The DC blocking capacitor is not required.
11	GND	Ground terminal. (0V)
12	RFIN1	RF input terminal of 800MHz band. The RF signal is input through external matching circuit connected to this terminal. The DC blocking capacitor is not required.

### CAUTION

- 1) Ground terminal (No.1, 5, 7, 11) should be connected to the ground plane as low inductance as possible.

# NJG1122PB4

## ELECTRICAL CHARACTERISTICS 1 (2.1GHz band High Gain Mode)

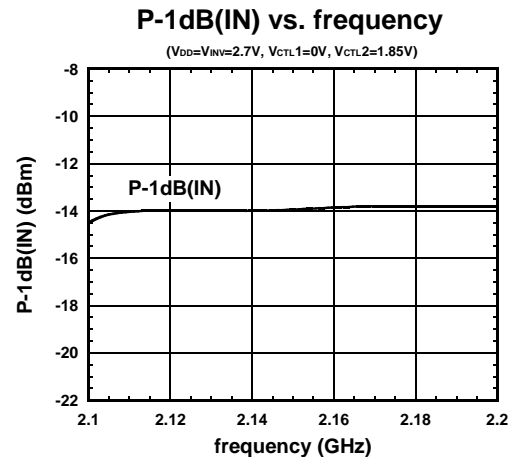
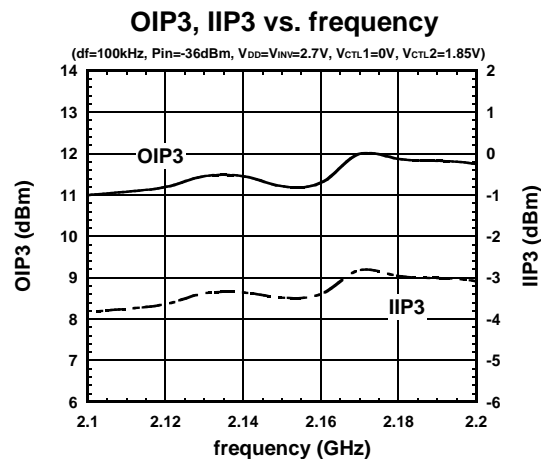
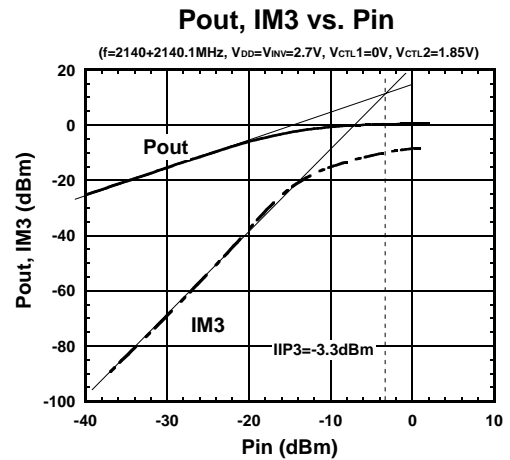
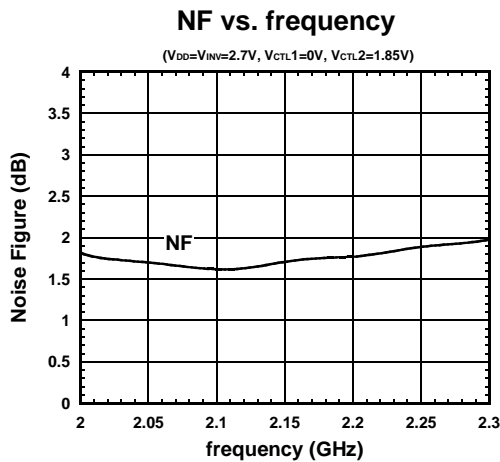
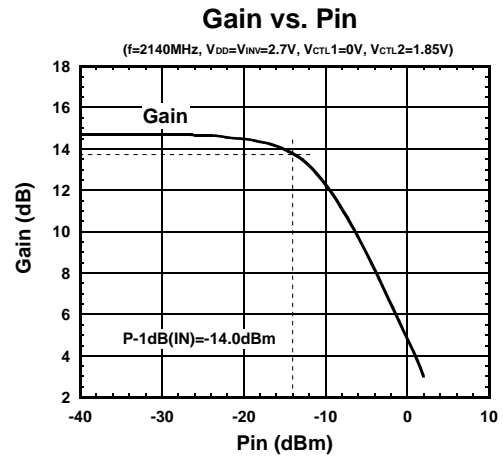
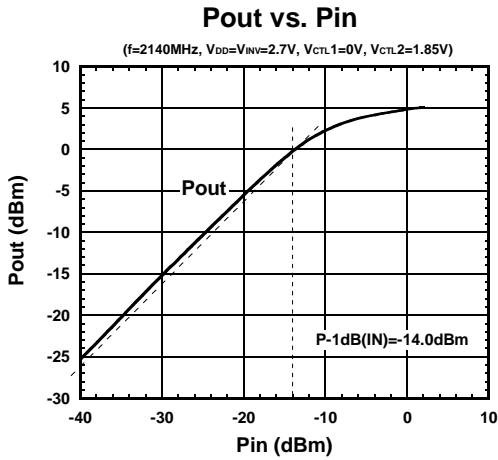

## ELECTRICAL CHARACTERISTICS 2 (2.1GHz band High Gain Mode)

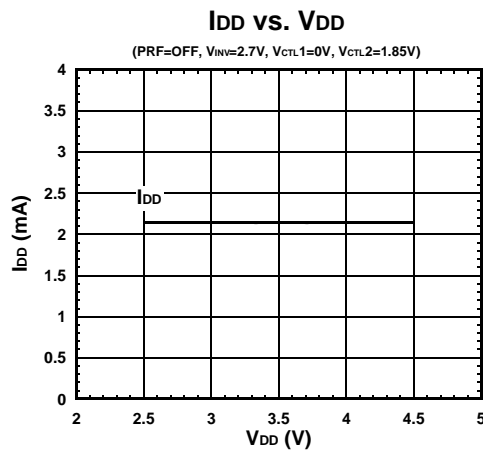
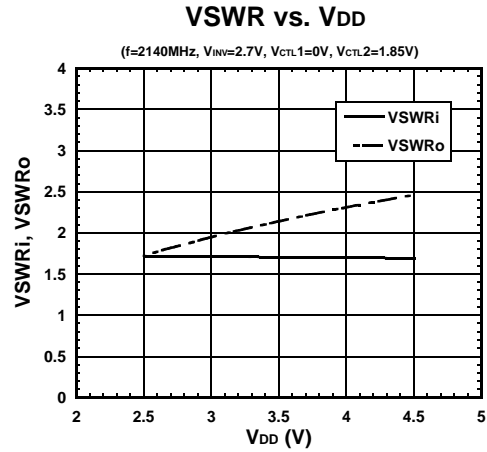
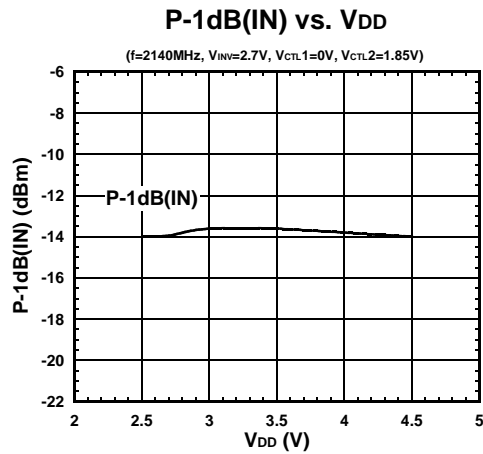
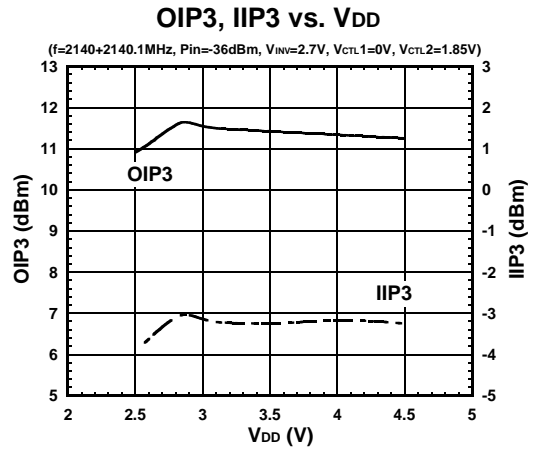
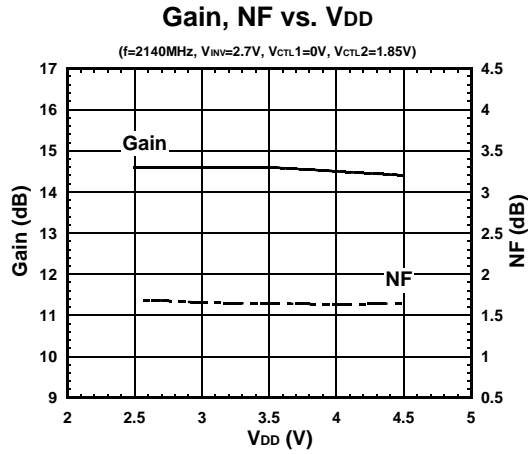

# NJG1122PB4

## ELECTRICAL CHARACTERISTICS 3 (2.1GHz band High Gain Mode)

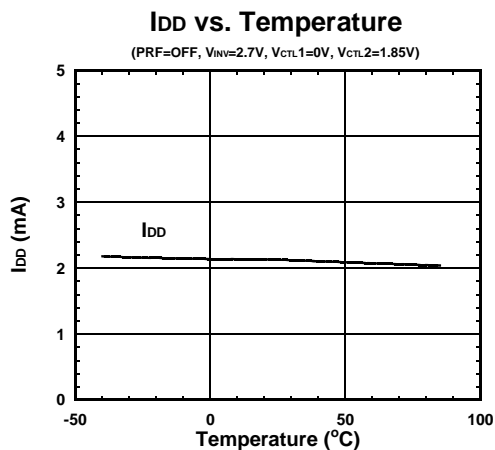
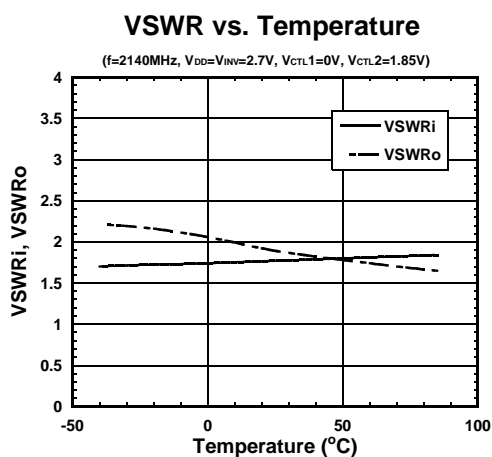
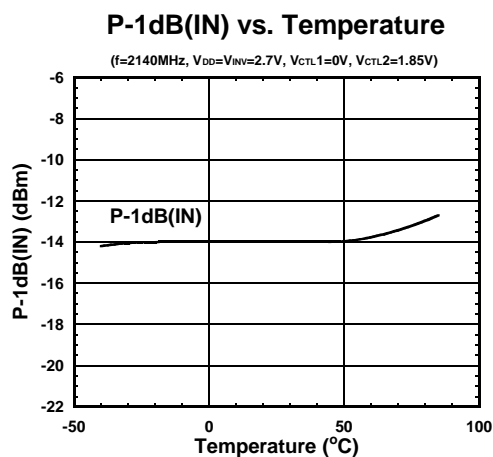
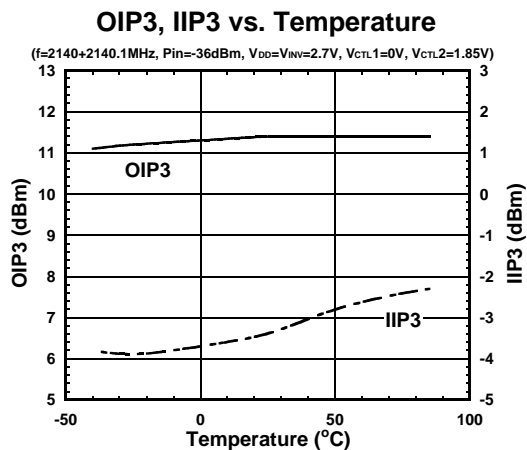
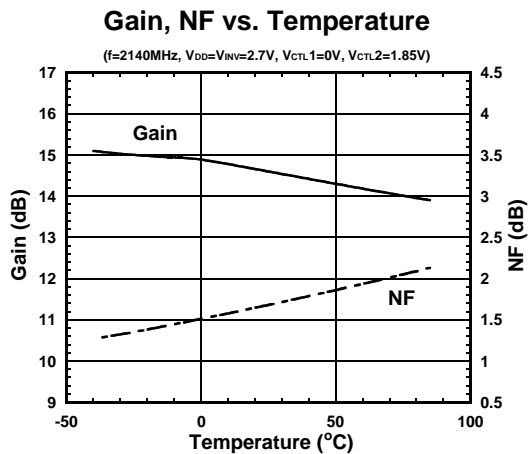



## ELECTRICAL CHARACTERISTICS 4 (2.1GHz band High Gain Mode)

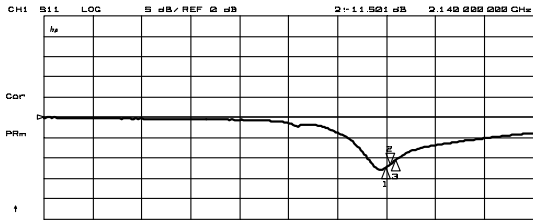

CH1 Markers  
 1: -12.382 dB  
 2: 11000 GHz  
 3: -10.433 dB  
 4: 17000 GHz

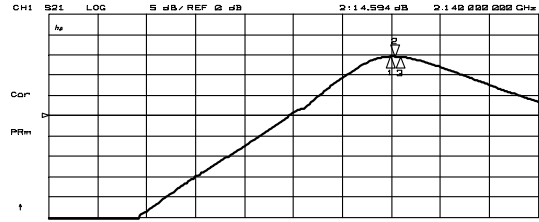

CH1 Markers  
 1: 14.628 dB  
 2: 11000 GHz  
 3: 14.532 dB  
 4: 17000 GHz

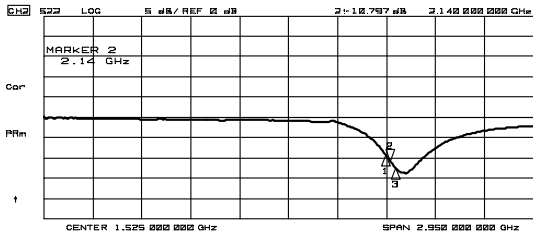

CH2 Markers  
 1: -9.1630 dB  
 2: 11000 GHz  
 3: -12.425 dB  
 4: 17000 GHz

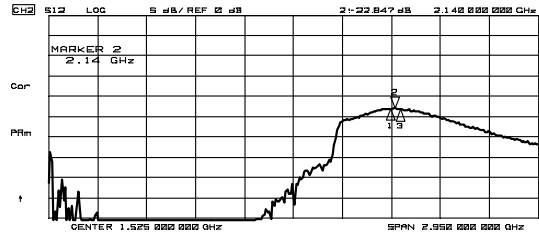

CH2 Markers  
 1: 23.217 dB  
 2: 11000 GHz  
 3: 23.294 dB  
 4: 17000 GHz



CH1 Markers  
 1: 1.6288  
 2: 11000 GHz  
 3: 1.8572  
 4: 17000 GHz

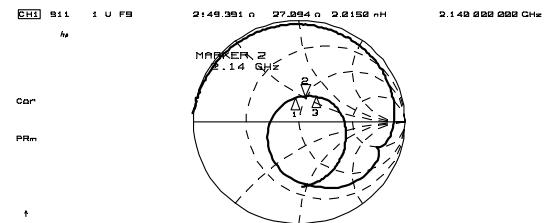

CH1 Markers  
 1: 141.698 n  
 2: 28.924 n  
 3: 11000 GHz  
 4: 59.816 n  
 5: 32.984 n  
 6: 17000 GHz

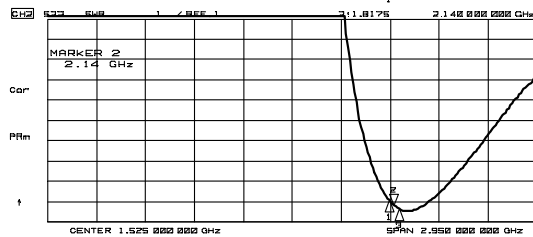

CH2 Markers  
 1: 2.8648  
 2: 11000 GHz  
 3: 11.6353  
 4: 17000 GHz

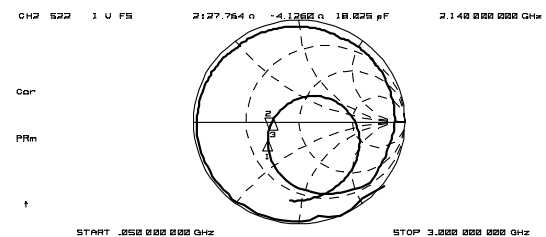

CH2 Markers  
 1: 25.644 n  
 2: -10.625 n  
 3: 11000 GHz  
 4: 39.617 n  
 5: 21.533 n  
 6: 17000 GHz

# NJG1122PB4

## ELECTRICAL CHARACTERISTICS 5 (2.1GHz band High Gain Mode)

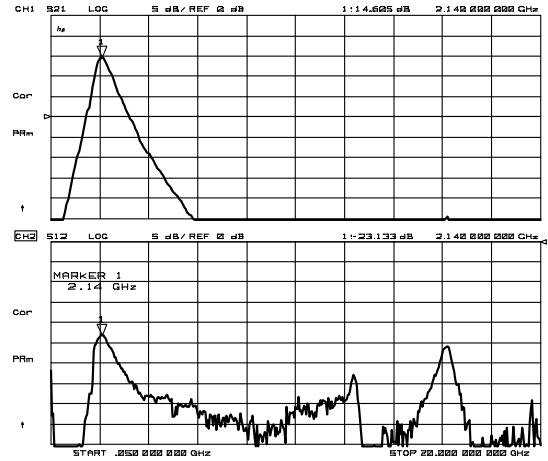
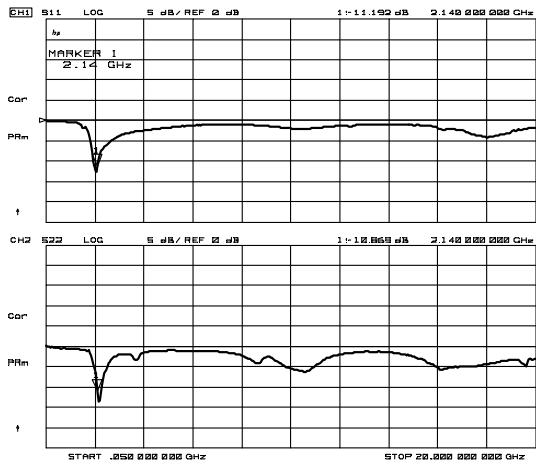

### k factor vs. frequency

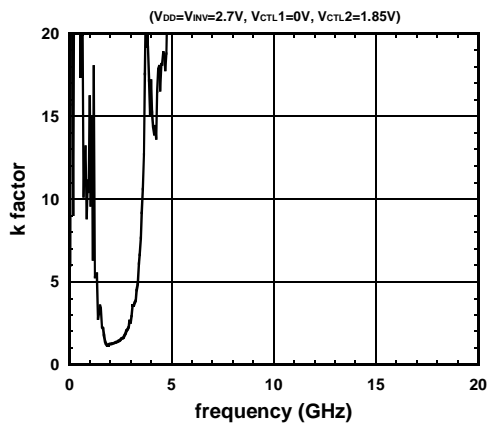

## ELECTRICAL CHARACTERISTICS 6 (2.1GHz band Low Gain Mode)

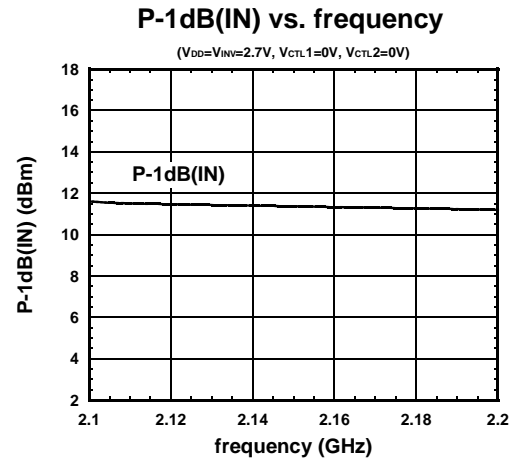
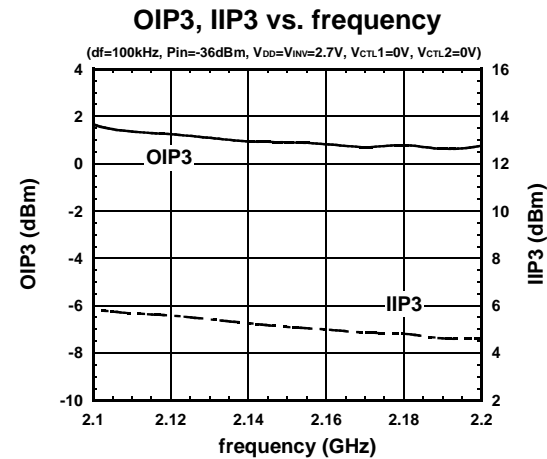
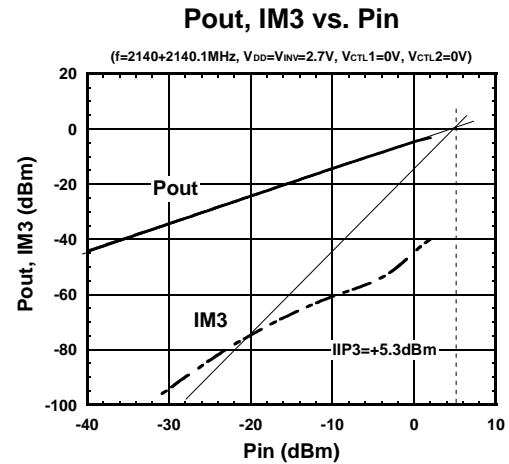
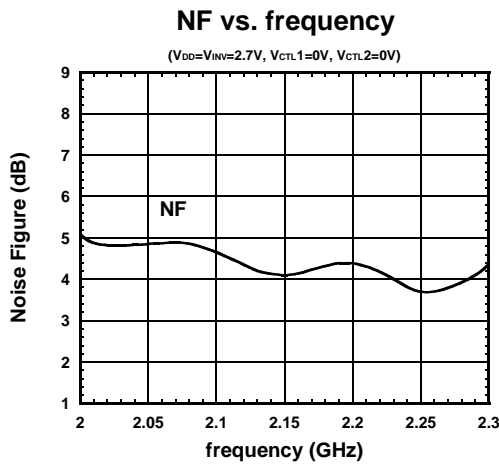
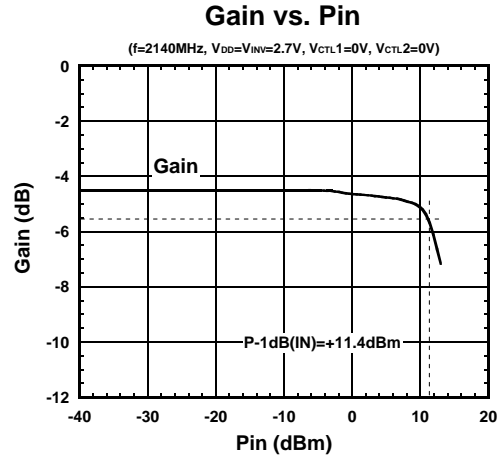
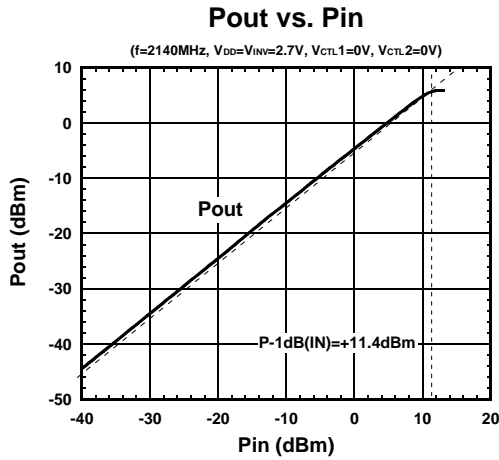

## ELECTRICAL CHARACTERISTICS 7 (2.1GHz band Low Gain Mode)

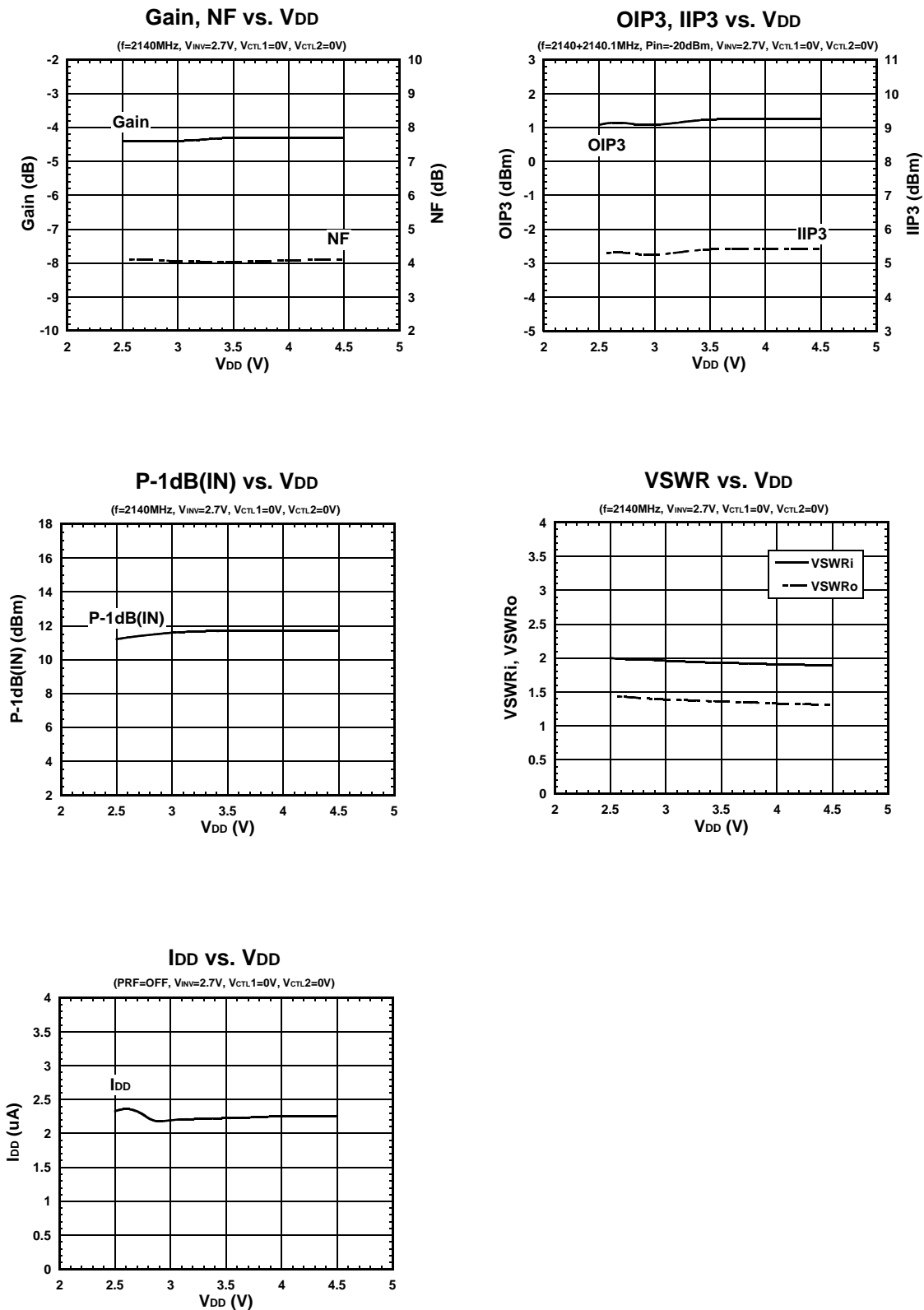

## ELECTRICAL CHARACTERISTICS 8 (2.1GHz band Low Gain Mode)

### Gain, NF vs. Temperature

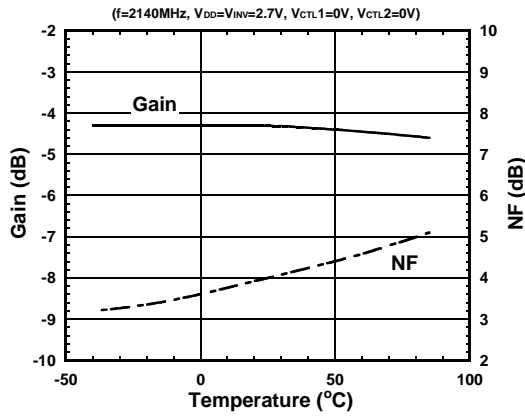

### OIP3, IIP3 vs. Temperature

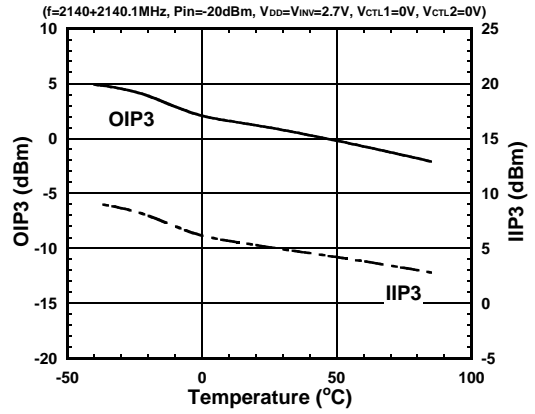

### P-1dB(IN) vs. Temperature

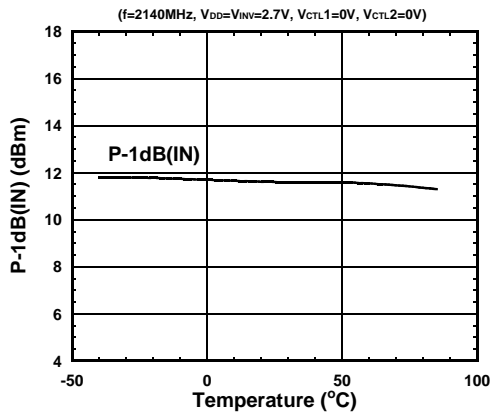

### VSWR vs. Temperature

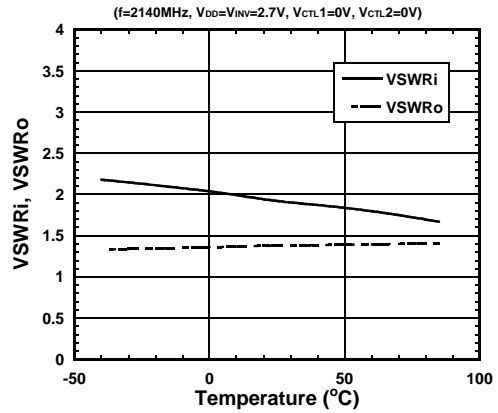

### I<sub>DD</sub> vs. Temperature

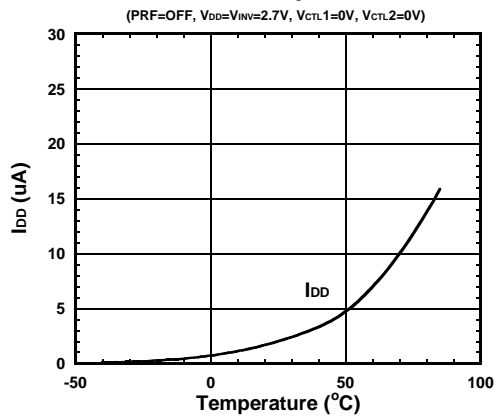

# NJG1122PB4

## ELECTRICAL CHARACTERISTICS 9(2.1GHz band Low Gain Mode)

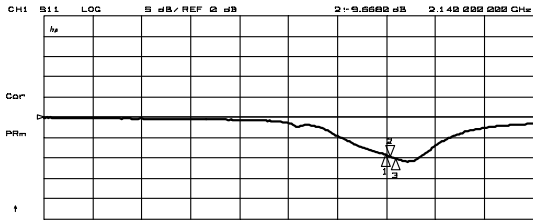

CH1 Markers  
 1: -9.2000 dB  
 2.11000 GHz  
 3: -10.185 dB  
 2.17000 GHz

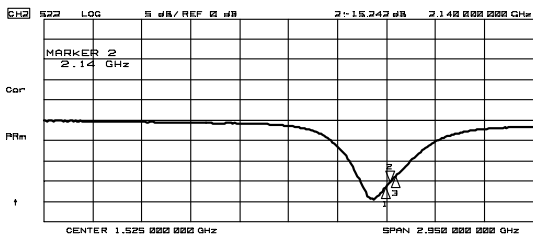

CH2 Markers  
 1: -16.630 dB  
 2.11000 GHz  
 3: -13.900 dB  
 2.17000 GHz

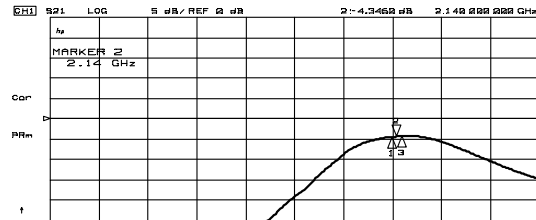

CH1 Markers  
 1: -4.4640 dB  
 2.11000 GHz  
 3: -4.2400 dB  
 2.17000 GHz

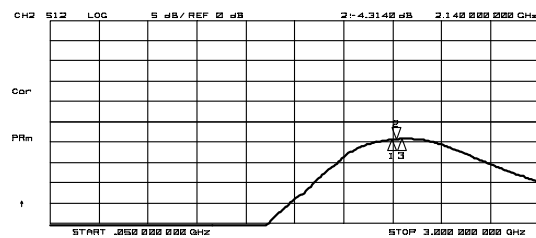

CH2 Markers  
 1: -4.4610 dB  
 2.11000 GHz  
 3: -4.2600 dB  
 2.17000 GHz

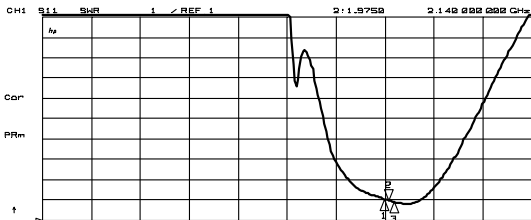

CH1 Markers  
 1: 2.8400  
 2.11000 GHz  
 3: 1.8930  
 2.17000 GHz

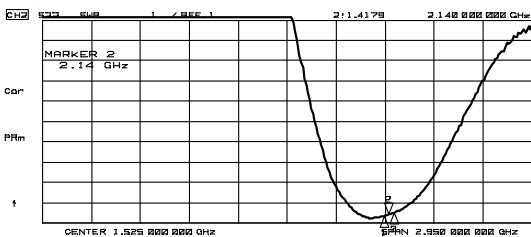

CH2 Markers  
 1: 1.2517  
 2.11000 GHz  
 3: 1.5000  
 2.17000 GHz

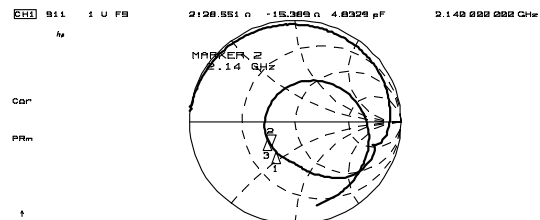

CH1 Markers  
 1: 29.848 n  
 -19.915 n  
 2.11000 GHz  
 3: 27.935 n  
 -18.200 n  
 2.17000 GHz

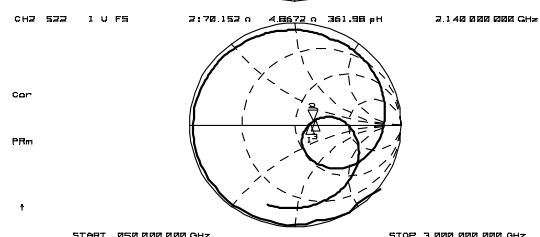

CH2 Markers  
 1: 66.807 n  
 1.9000 n  
 2.11000 GHz  
 3: 74.150 n  
 2.4141 n  
 2.17000 GHz

## ELECTRICAL CHARACTERISTICS 10(2.1GHz band Low Gain Mode)

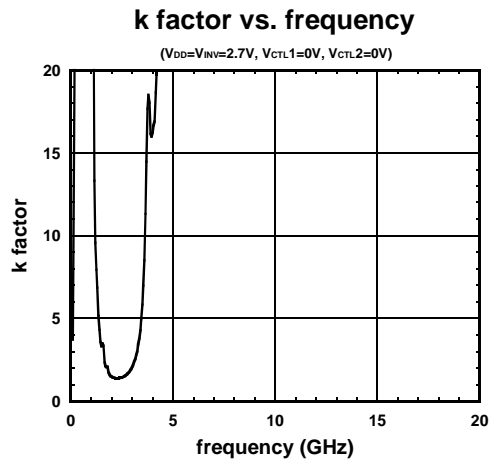
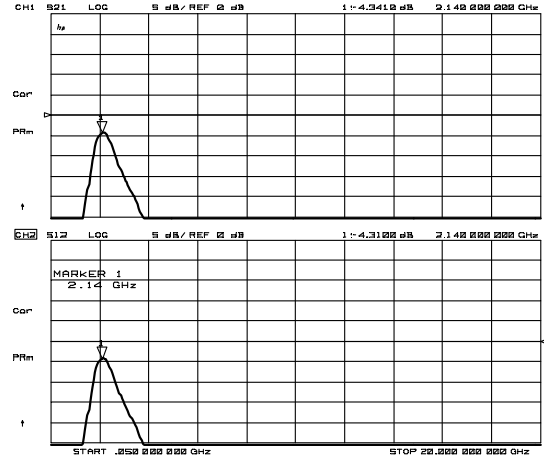
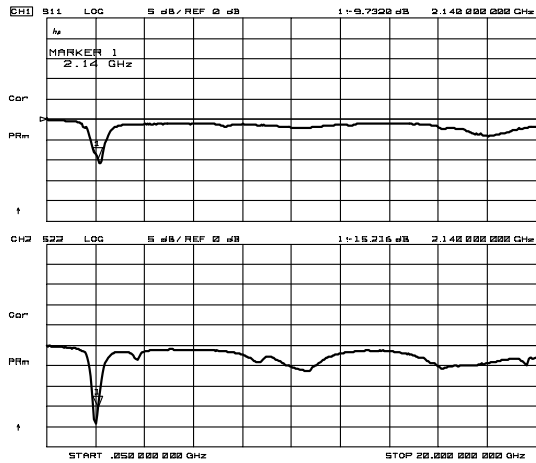

# NJG1122PB4

## ELECTRICAL CHARACTERISTICS 11(800MHz band High Gain Mode)

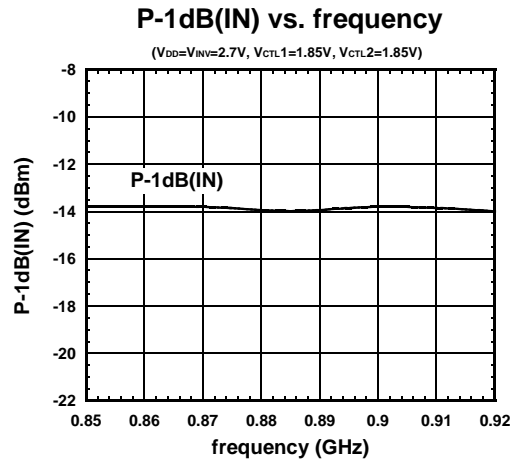
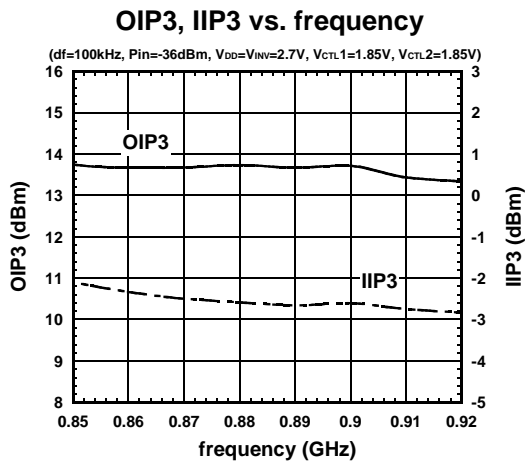
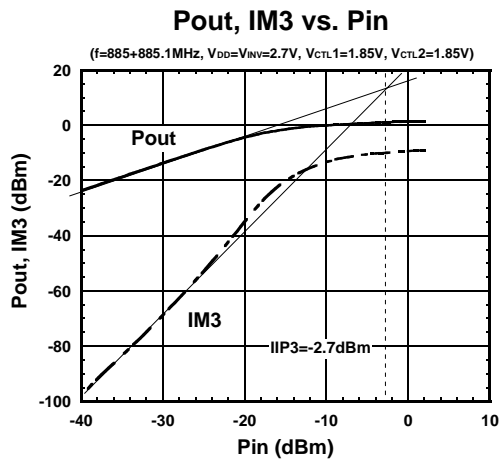
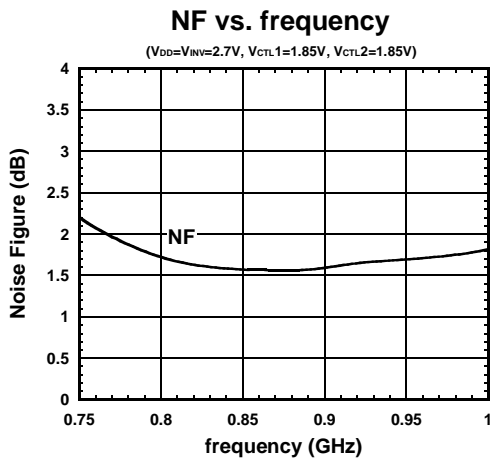
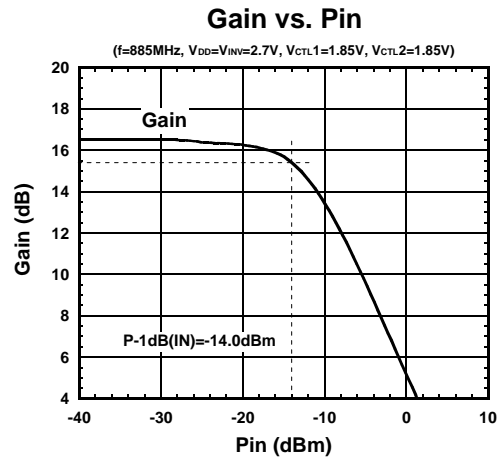
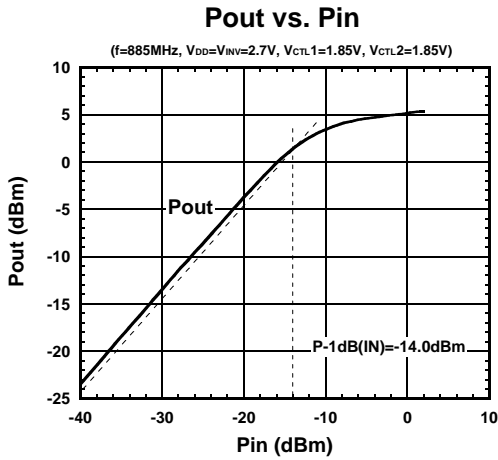



## ELECTRICAL CHARACTERISTICS 12(800MHz band High Gain Mode)

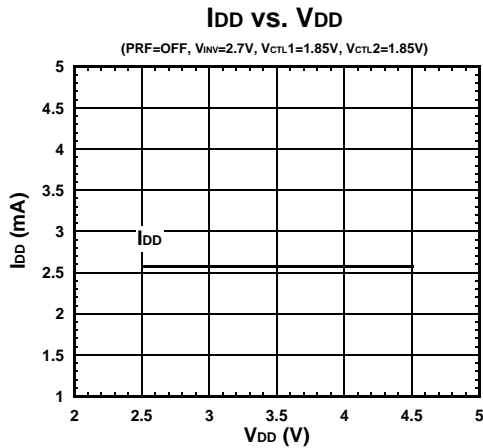
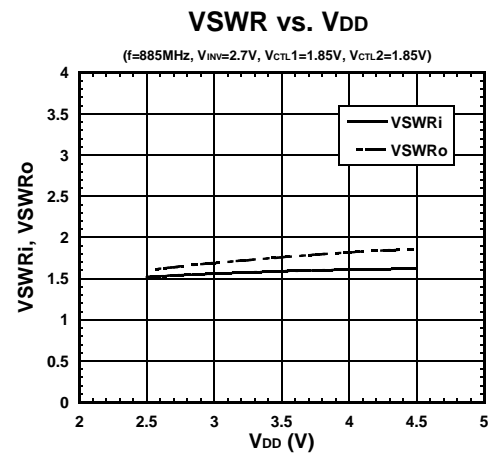
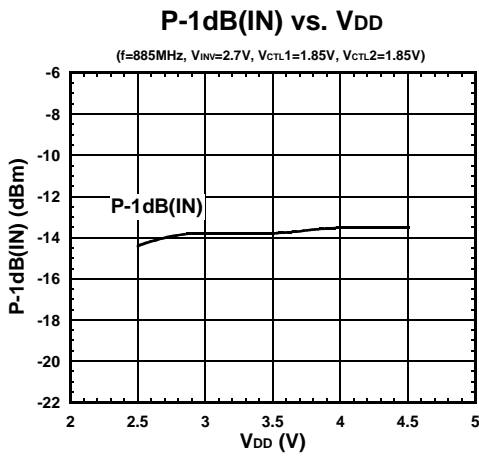
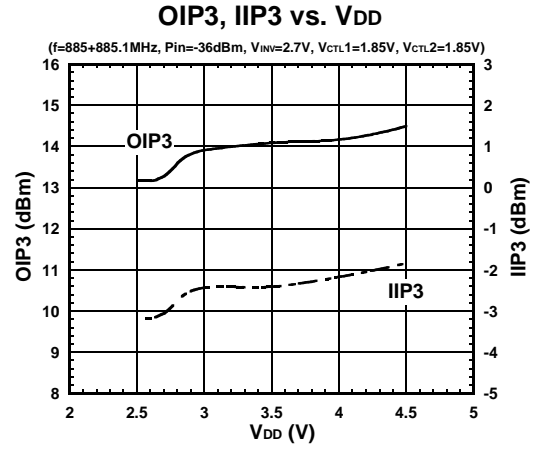
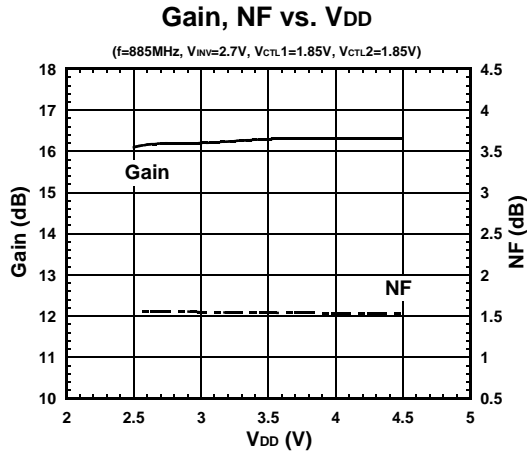

# NJG1122PB4

## ELECTRICAL CHARACTERISTICS 13(800MHz band High Gain Mode)

**Gain, NF vs. Temperature**

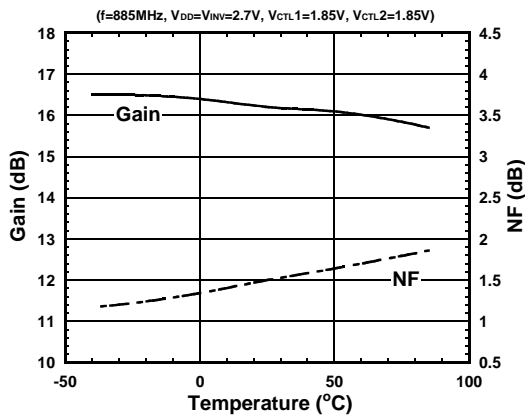

**OIP3, IIP3 vs. Temperature**

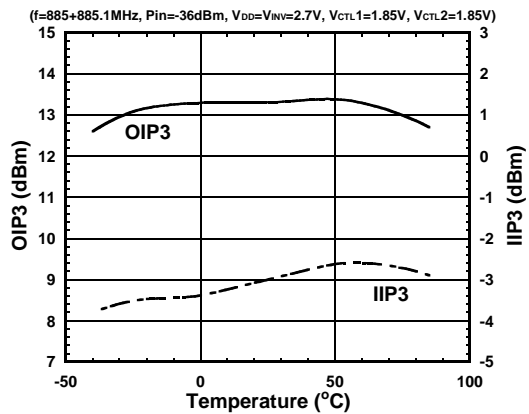

**P-1dB(IN) vs. Temperature**

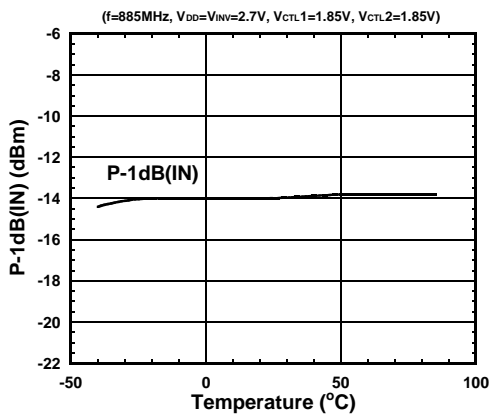

**VSWR vs. Temperature**

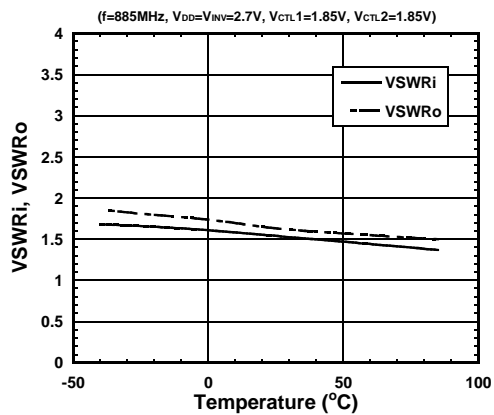

**I<sub>DD</sub> vs. Temperature**

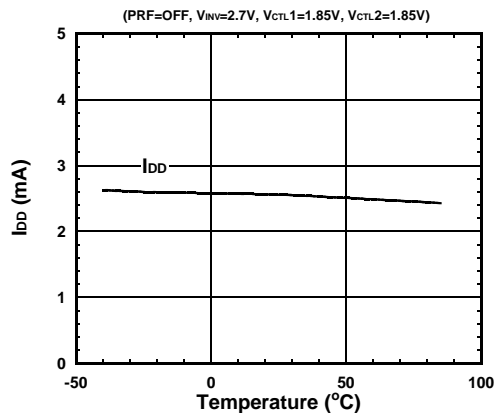

## ELECTRICAL CHARACTERISTICS 14(800MHz band High Gain Mode)

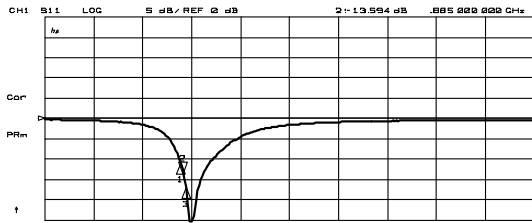

CH1 Markers  
 1: -10.925 dB  
 869.000 MHz  
 3: -16.976 dB  
 900.000 MHz

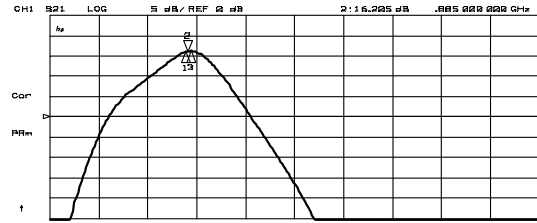
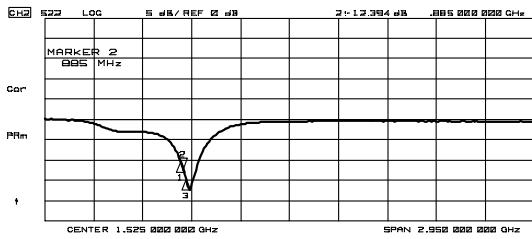

CH1 Markers  
 1: 16.076 dB  
 869.000 MHz  
 3: 16.238 dB  
 900.000 MHz

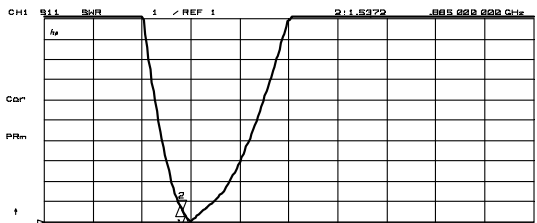
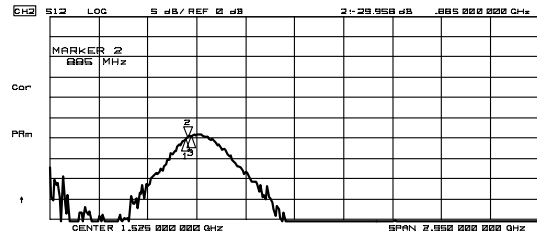

CH1 Markers  
 1: 1.0021  
 869.000 MHz  
 3: 1.3279  
 900.000 MHz

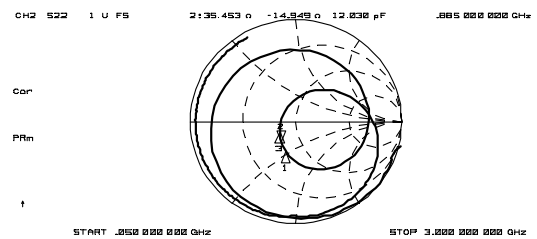
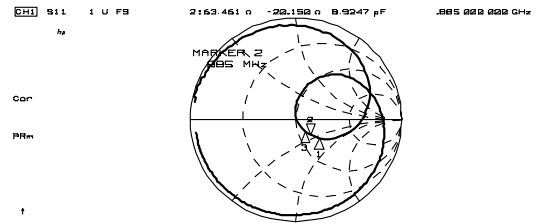
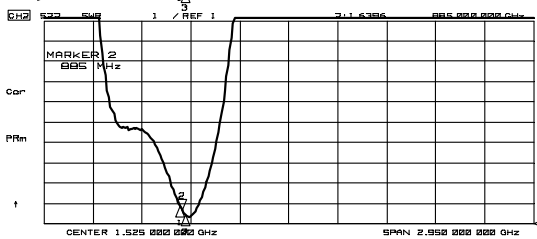

# NJG1122PB4

## ELECTRICAL CHARACTERISTICS 15(800MHz band High Gain Mode)

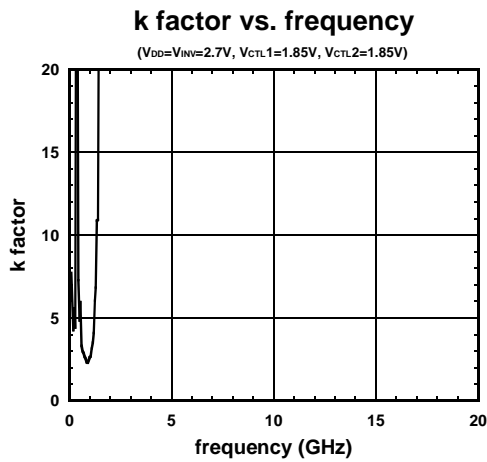
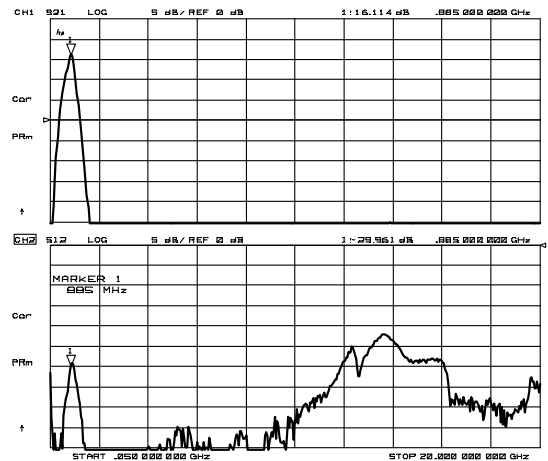
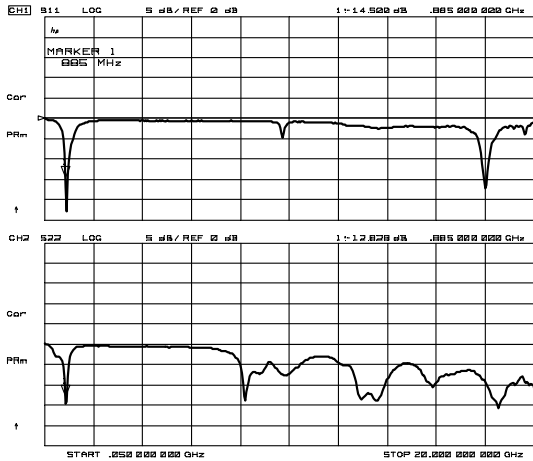

## ELECTRICAL CHARACTERISTICS 16(800MHz band Low Gain Mode)

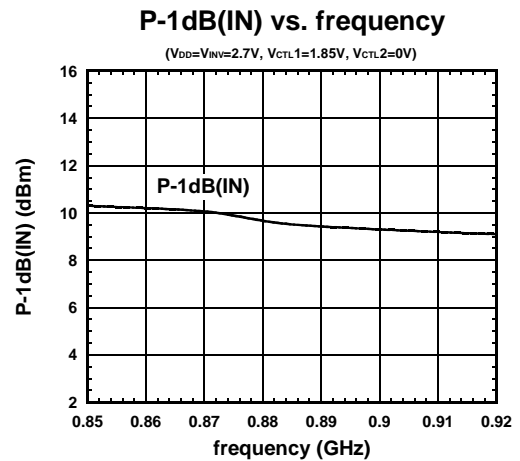
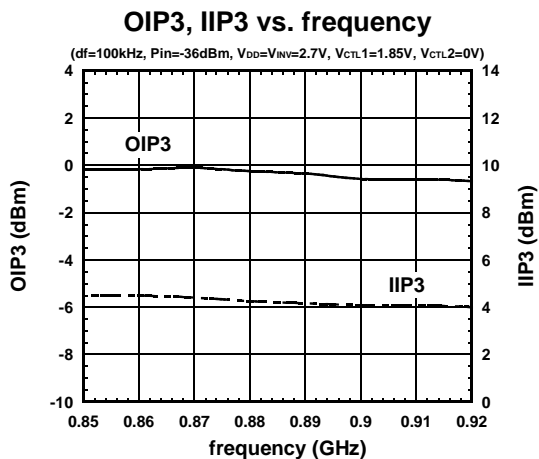
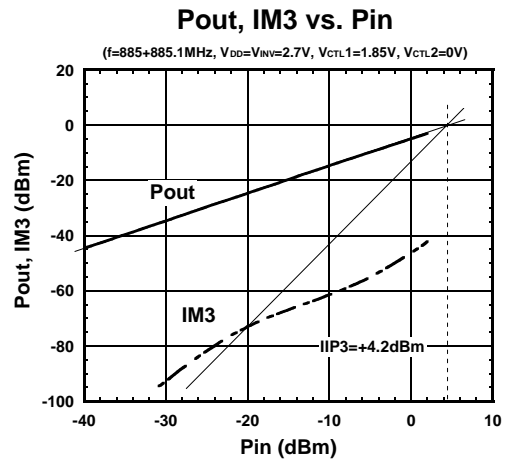
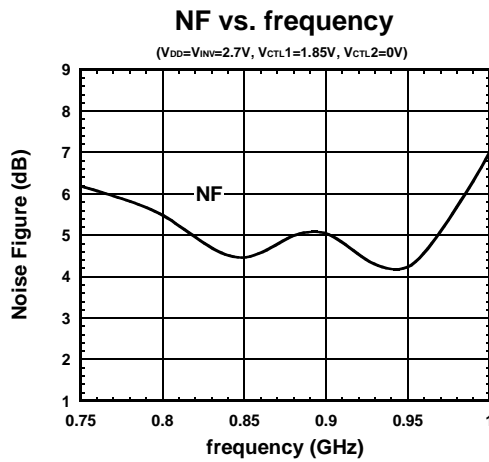
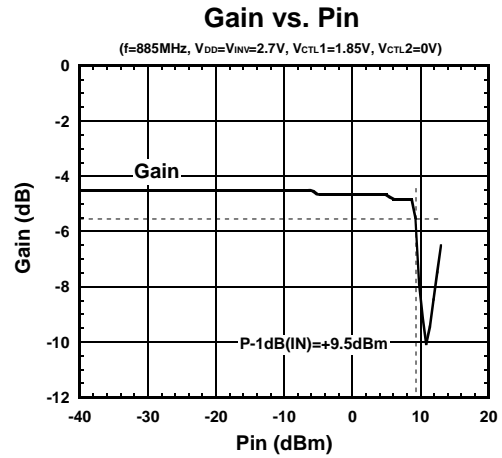
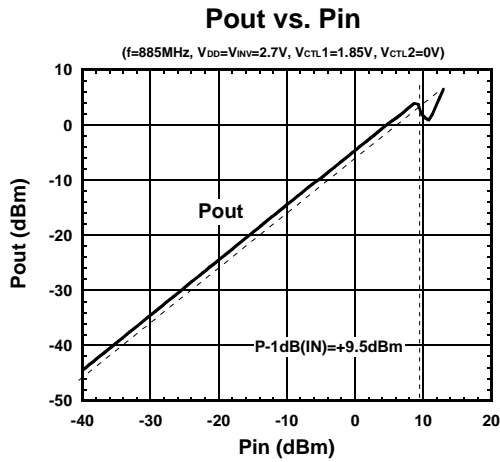

# NJG1122PB4

## ELECTRICAL CHARACTERISTICS 17(800MHz band Low Gain Mode)

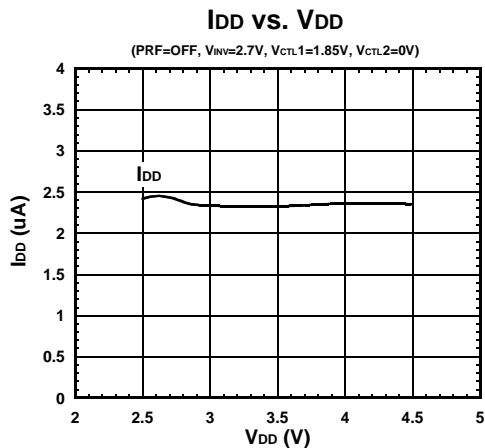
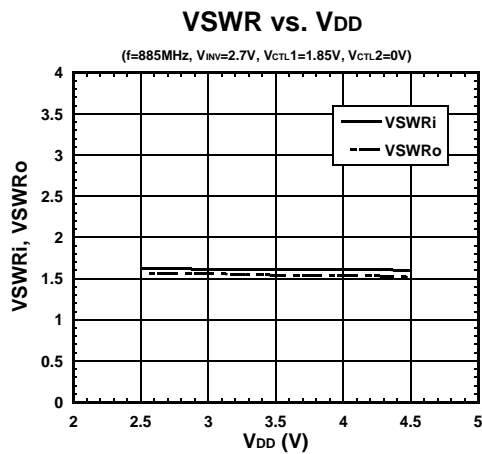
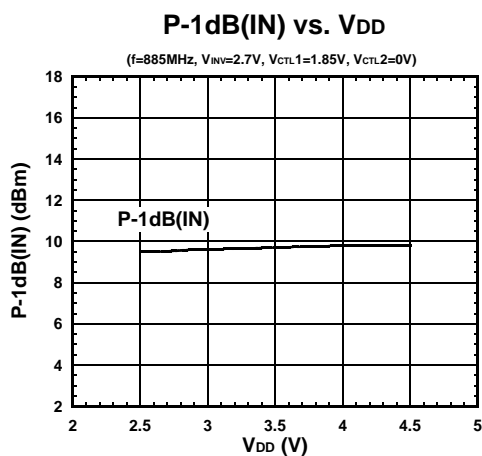
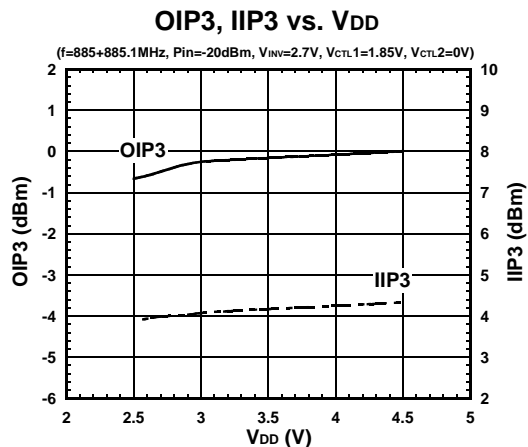
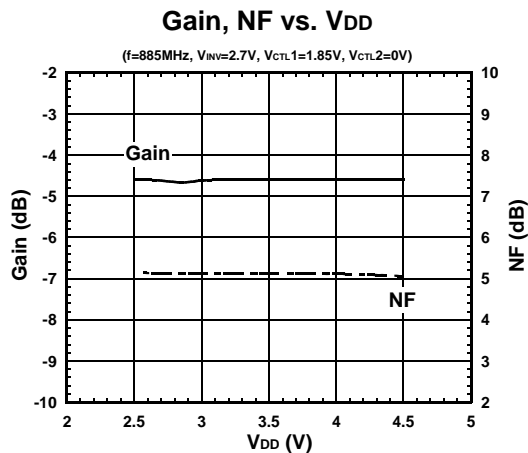

## ELECTRICAL CHARACTERISTICS 18(800MHz band Low Gain Mode)

### Gain, NF vs. Temperature

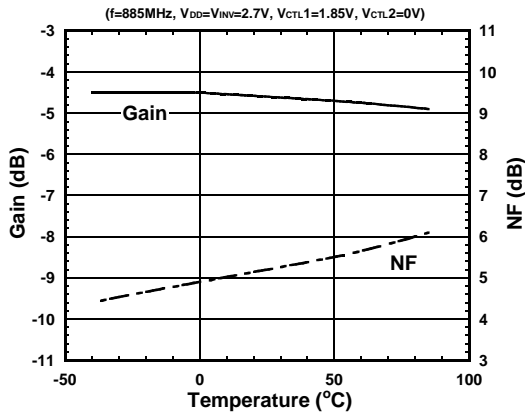

### OIP3, IIP3 vs. Temperature

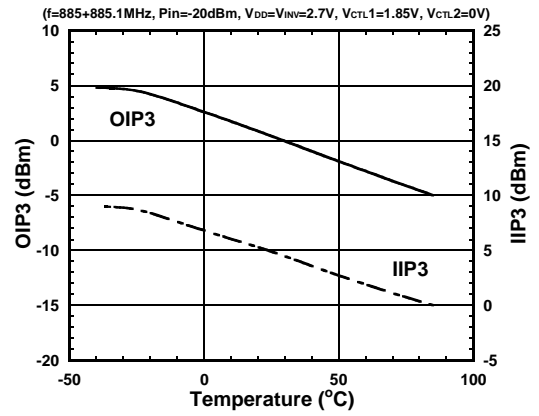

### P-1dB(IN) vs. Temperature

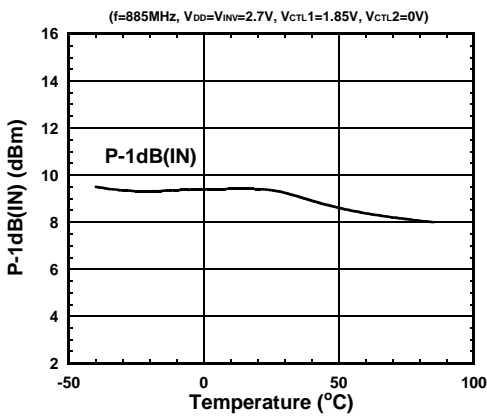

### VSWR vs. Temperature

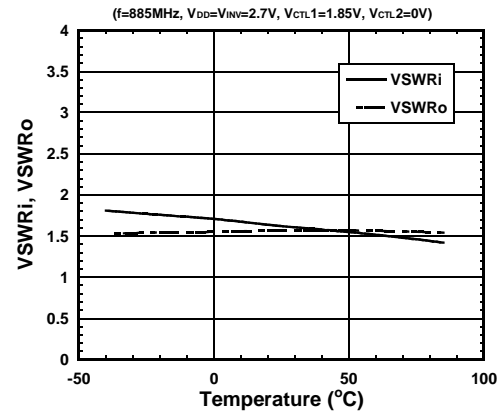

### I<sub>DD</sub> vs. Temperature

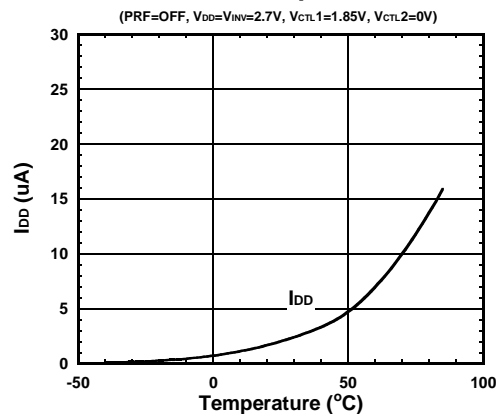

# NJG1122PB4

## ELECTRICAL CHARACTERISTICS 19(800MHz band Low Gain Mode)

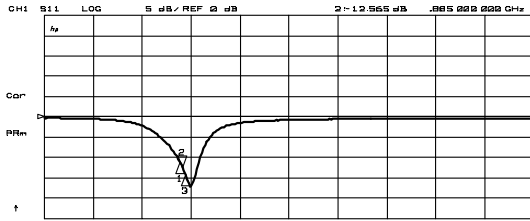

CH1 Markers  
 1:- 11.386 dB  
 869.000 MHz  
 3:- 14.148 dB  
 900.000 MHz

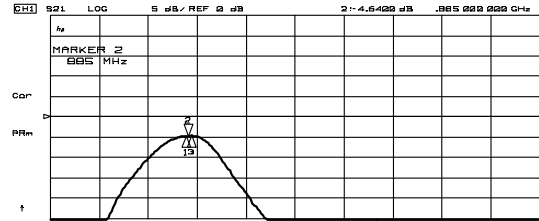

CH1 Markers  
 1:- -4.6570 dB  
 869.000 MHz  
 3:- -4.6230 dB  
 900.000 MHz

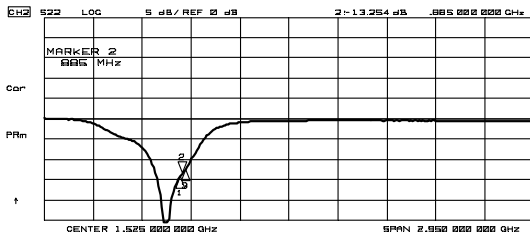

CH2 Markers  
 1:- 14.233 dB  
 869.000 MHz  
 3:- 12.446 dB  
 900.000 MHz

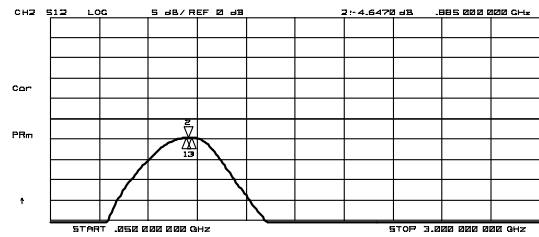

CH2 Markers  
 1:- -4.6730 dB  
 869.000 MHz  
 3:- -4.6310 dB  
 900.000 MHz

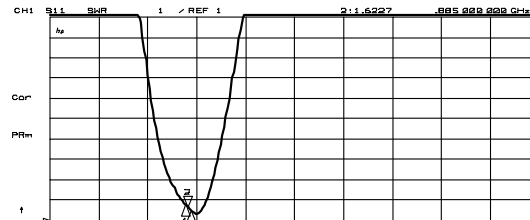

CH1 Markers  
 1:- 1.7950  
 869.000 MHz  
 3:- -1.4901  
 900.000 MHz

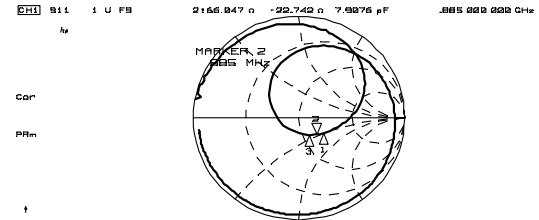

CH1 Markers  
 1:- 70.887 n  
 -24.375 n  
 869.000 MHz  
 3:- 67.955 n  
 -19.919 n  
 900.000 MHz

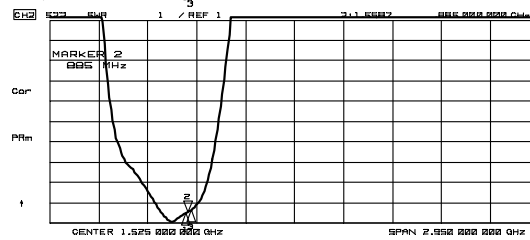

CH2 Markers  
 1:- 1.4925  
 869.000 MHz  
 3:- 1.6270  
 900.000 MHz

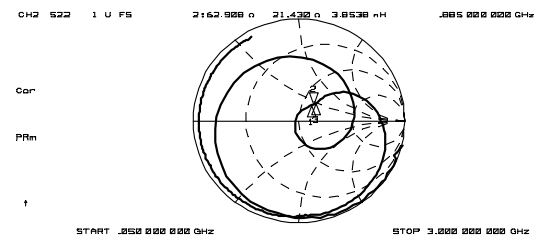

CH2 Markers  
 1:- 60.601 n  
 19.199 n  
 869.000 MHz  
 3:- 64.934 n  
 23.730 n  
 900.000 MHz



## ELECTRICAL CHARACTERISTICS 20(800MHz band Low Gain Mode)

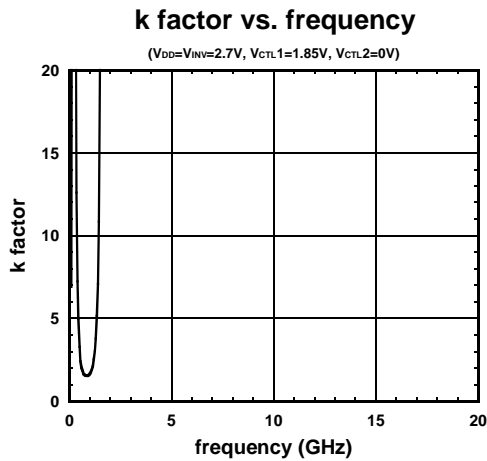
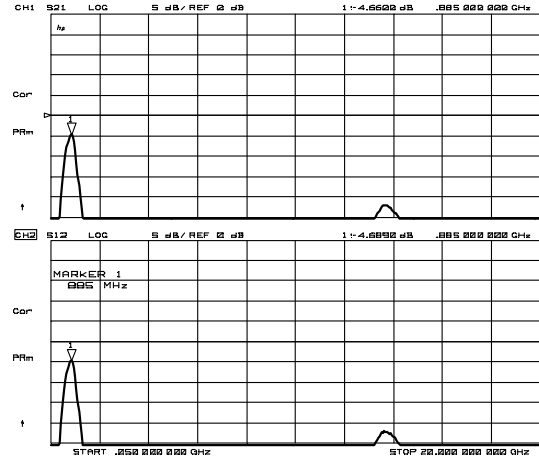
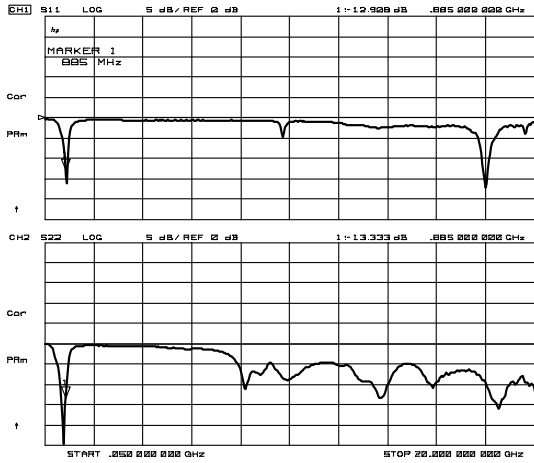

# NJG1122PB4

## TEST CIRCUIT

(Top View)

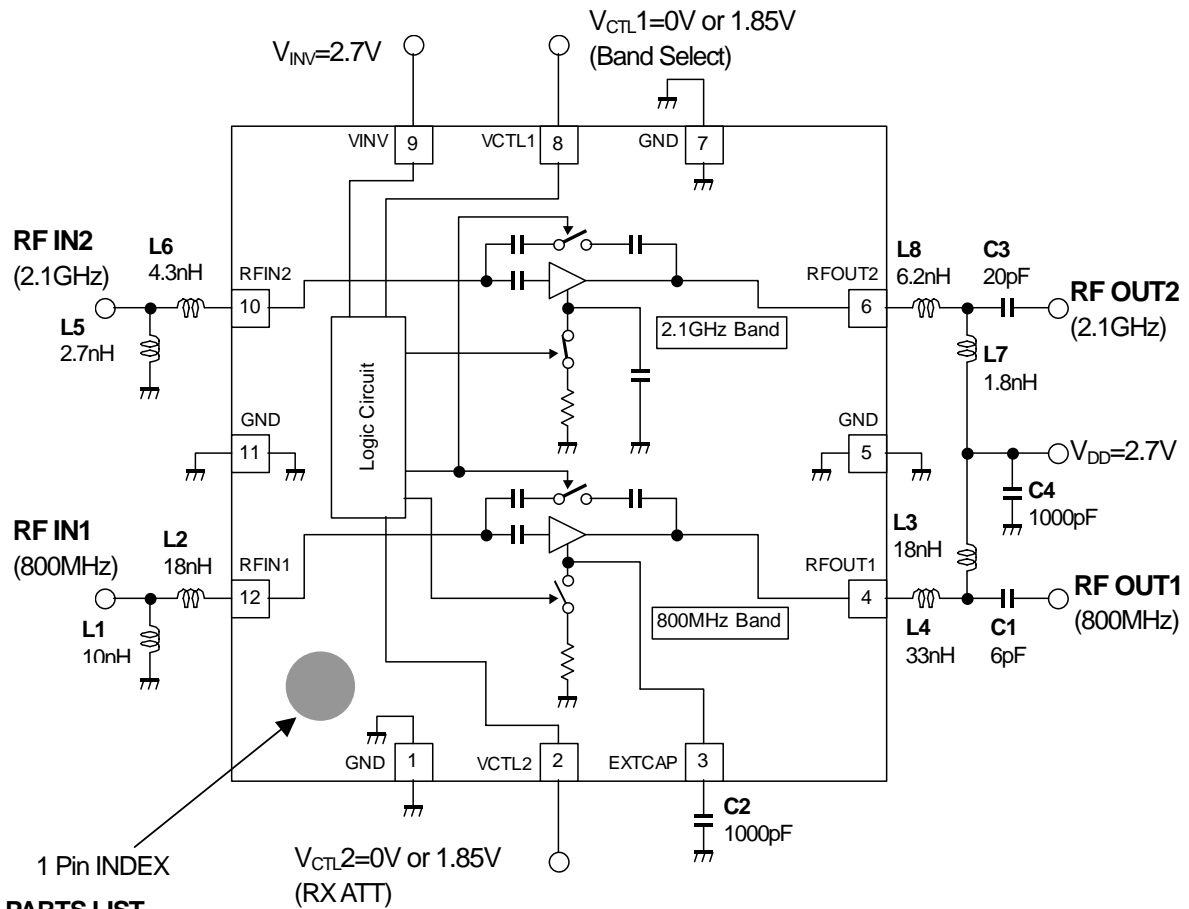

## TRUTH TABLE

"H"= $V_{CTL}(H)$ , "L"= $V_{CTL}(L)$

Control voltage		800MHz band		2.1GHz band	
$V_{CTL1}$ Band select	$V_{CTL2}$ RX ATT	LNA $I_{DD}$	Bypass circuit	LNA $I_{DD}$	Bypass circuit
L	L	OFF	ON	OFF	ON
L	H	OFF	OFF	ON	OFF
H	L	OFF	ON	OFF	ON
H	H	ON	OFF	OFF	OFF

RECOMMENDED DESIGN

(Top View)

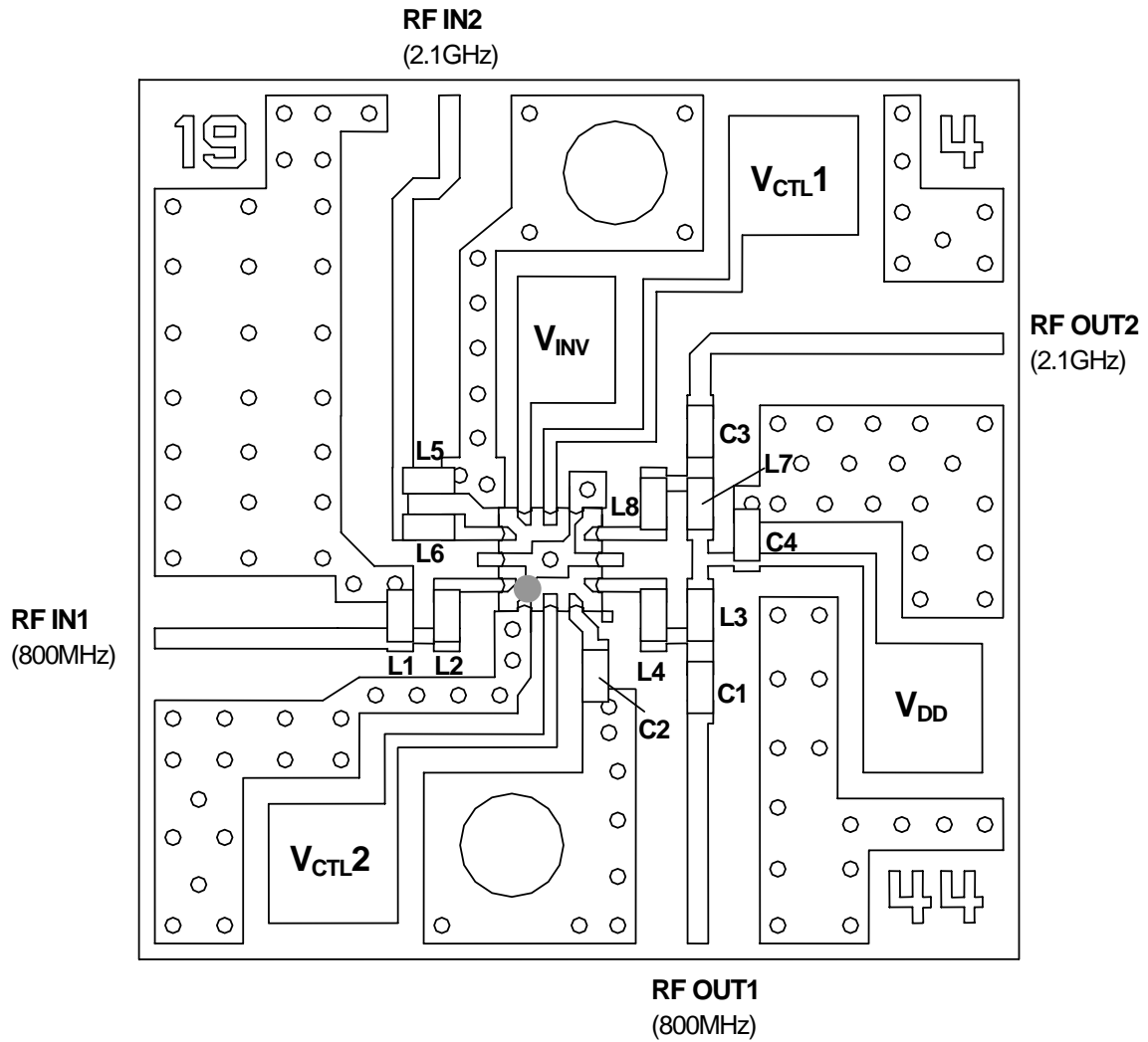

PCB (FR-4):  $t=0.2\text{mm}$   
 MICROSTRIP LINE WIDTH=0.4mm ( $Z_0=50\Omega$ )  
 PCB SIZE=17.0mmx17.0mm

# NJG1122PB4

## PACKAGE OUTLINE (FFP12-B4)

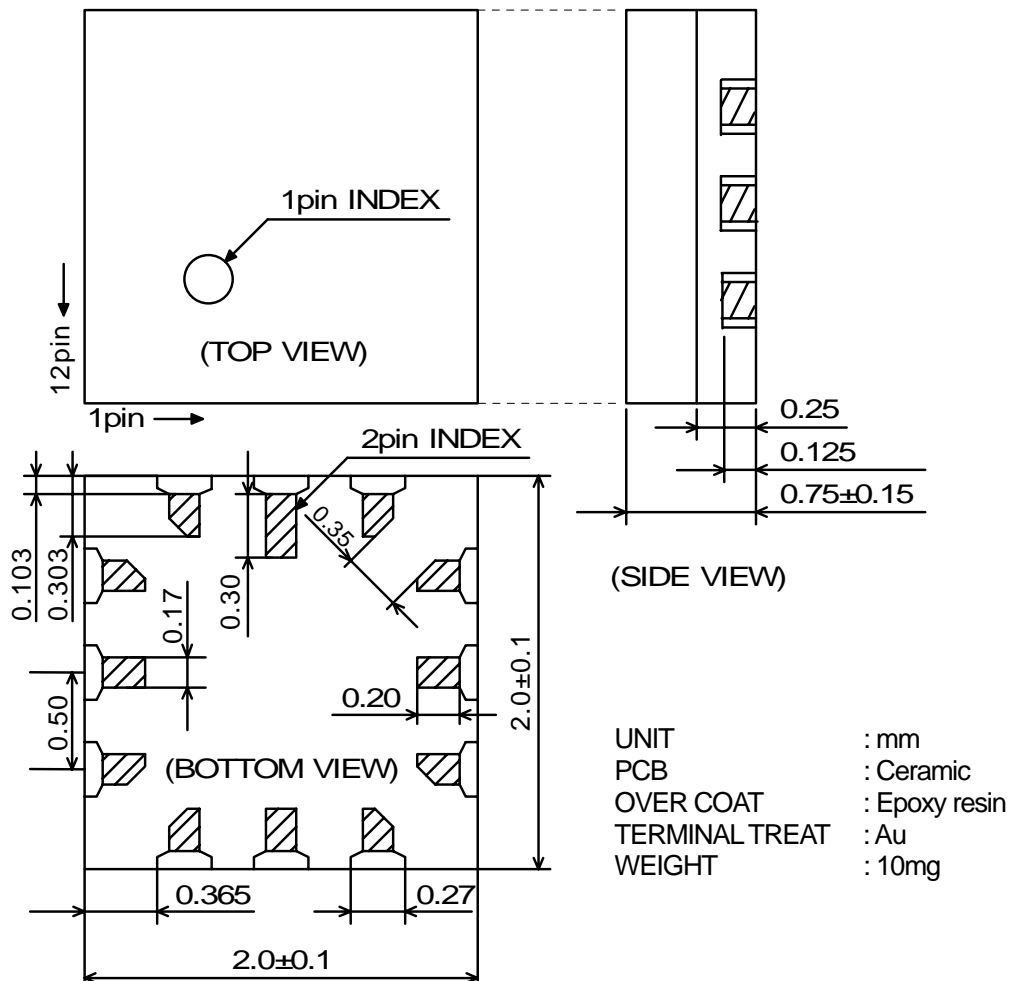

### Cautions on using this product

This product contains Gallium-Arsenide (GaAs) which is a harmful material.

- Do NOT eat or put into mouth.
- Do NOT dispose in fire or break up this product.
- Do NOT chemically make gas or powder with this product.
- To waste this product, please obey the relating law of your country.

### [CAUTION]

The specifications on this databook are only given for information, without any guarantee as regards either mistakes or omissions. The application circuits in this databook are described only to show representative usages of the product and not intended for the guarantee or permission of any right including the industrial rights.

This product may be damaged with electric static discharge (ESD) or spike voltage. Please handle with care to avoid these damages.