

## 1.8/1.9/2.1GHz BAND LOW NOISE AMPLIFIER GaAs MMIC

### ■GENERAL DESCRIPTION

NJG1105F is a Low Noise Amplifier GaAs MMIC designed for 1.8/1.9/2.1GHz digital cellular phone handsets such as DCS1800, PCS and W-CDMA.

This amplifier provides low noise figure, high gain and high IP3 operated by single low positive power supply.

### ■PACKAGE OUTLINE

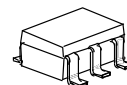

NJG1105F

### ■FEATURES

- Low voltage operation +2.8V typ.
- Low current consumption 7mA typ.
- High small signal gain 19dB typ. @f=1860MHz  
18dB typ. @f=1960MHz  
15dB typ. @f=2140MHz
- Low Noise Figure 1.7dB typ. @f=1860/1960/2140MHz
- High Input IP3 -3dBm typ. @f=1860.0+1860.1MHz  
-3dBm typ. @f=1960.0+1960.1MHz  
+1dBm typ. @f=2140.0+2140.1MHz
- Package MTP6 (Mount Size: 2.8x2.9x1.2mm)

### ■PIN CONFIGURATION

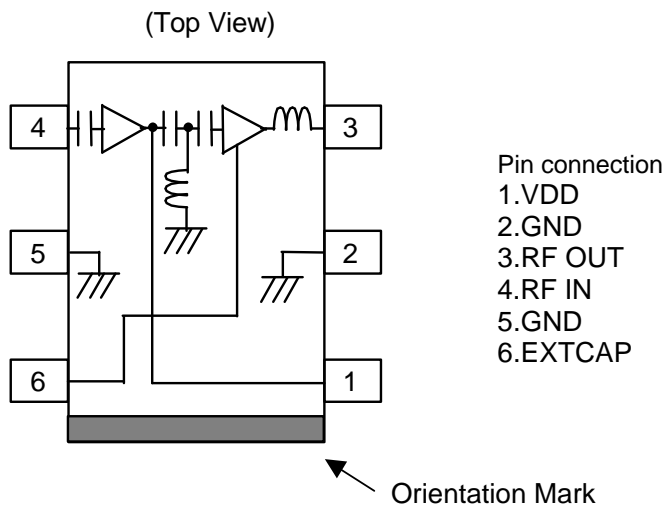

Note: Specifications and description listed in this catalog are subject to change without prior notice.

# NJG1105F

## ■ABSOLUTE MAXIMUM RATINGS

(T <sub>a</sub> =+25°C, Z <sub>s</sub> =Z <sub>i</sub> =50Ω)				
PARAMETER	SYMBOL	CONDITIONS	RATINGS	UNITS
Drain Voltage	V <sub>DD</sub>		6.5	V
Input Power	P <sub>in</sub>	V <sub>DD</sub> =2.8V	+15	dBm
Power Dissipation	P <sub>D</sub>		150	mW
Operating Temp.	T <sub>opr</sub>		-40~+85	°C
Storage Temp.	T <sub>stg</sub>		-55~+125	°C

## ■ELECTRICAL CHARACTERISTICS 1 (1.8GHz Band)

(V<sub>DD</sub>=2.8V, f=1860MHz, T<sub>a</sub>=+25°C, Z<sub>s</sub>=Z<sub>i</sub>=50Ω, with application circuit)

PARAMETER	SYMBOL	CONDITIONS	MIN	TYP	MAX	UNITS
Operating Frequency	Freq		1840	1860	1870	MHz
Drain Voltage	V <sub>DD</sub>		2.7	2.8	5.5	V
Operating Current	I <sub>DD</sub>	RF OFF	-	7.0	8.5	mA
Small Signal Gain	Gain		17.0	19.0	21.0	dB
Gain Flatness	G <sub>flat</sub>	f=1840~1870MHz	-	0.5	1.0	dB
Noise Figure	NF		-	1.7	2.0	dB
Pout at 1dB Gain Compression point	P <sub>-1dB</sub>		+1.0	+5.0	-	dBm
Input 3rd Order Intercept Point	IIP3	f=1860.0+1860.1MHz, Pin=-35dBm	-7.0	-3.0	-	dBm
LNAIN Port VSWR	VSWR <sub>i</sub>		-	1.5	2.0	
LNAOUT Port VSWR	VSWR <sub>o</sub>		-	1.5	2.0	
Stability		IN/OUT terminal: open or short, No RF input, T <sub>a</sub> =20~80°C, freq<20GHz	Spurious: -60dBm max. No return gain			

## ■ELECTRICAL CHARACTERISTICS 2 (1.9GHz Band)

(V<sub>DD</sub>=2.8V, f=1960MHz, T<sub>a</sub>=+25°C, Z<sub>s</sub>=Z<sub>i</sub>=50Ω, with application circuit)

PARAMETER	SYMBOL	CONDITIONS	MIN	TYP	MAX	UNITS
Operating Frequency	Freq		1930	1960	1990	MHz
Drain Voltage	V <sub>DD</sub>		2.7	2.8	5.5	V
Operating Current	I <sub>DD</sub>	RF OFF	-	7.0	8.5	mA
Small Signal Gain	Gain		16.0	18.0	20.0	dB
Gain Flatness	G <sub>flat</sub>	f=1930~1990MHz	-	0.5	1.0	dB
Noise Figure	NF		-	1.7	2.0	dB
Pout at 1dB Gain Compression point	P <sub>-1dB</sub>		+1.0	+4.0	-	dBm
Input 3rd Order Intercept Point	IIP3	f=1960.0+1960.1MHz, Pin=-35dBm	-7.0	-3.0	-	dBm
LNAIN Port VSWR	VSWR <sub>i</sub>		-	1.5	2.0	
LNAOUT Port VSWR	VSWR <sub>o</sub>		-	1.5	2.0	
Stability		IN/OUT terminal: open or short, No RF input, T <sub>a</sub> =20~80°C, freq<20GHz	Spurious: -60dBm max. No return gain			

## ■ELECTRICAL CHARACTERISTICS 3 (2.1GHz Band)

( $V_{DD}=2.8V$ ,  $f=2140MHz$ ,  $T_a=+25^{\circ}C$ ,  $Z_s=Z_l=50\Omega$ , with application circuit)

PARAMETER	SYMBOL	CONDITIONS	MIN	TYP	MAX	UNITS
Operating Frequency	Freq		2110	2140	2170	MHz
Drain Voltage	$V_{DD}$		2.7	2.8	5.5	V
Operating Current	$I_{DD}$	RF OFF	-	7.0	8.5	mA
Small Signal Gain	Gain		13.0	15.0	17.0	dB
Gain Flatness	$G_{flat}$	$f=2110\sim 2140MHz$	-	0.5	1.0	dB
Noise Figure	NF		-	1.7	1.9	dB
Pout at 1dB Gain Compression point	$P_{-1dB}$		+1.0	+4.0	-	dBm
Input 3rd Order Intercept Point	IIP3	$f=2140.0+2140.1MHz$ , $P_{in}=-35dBm$	-4.0	+1.0	-	dBm
LNAIN Port VSWR	$VSWR_i$		-	1.5	2.0	
LNAOUT Port VSWR	$VSWR_o$		-	1.5	2.0	
Stability		IN/OUT terminal: open or short, No RF input, $T_a=20\sim 80^{\circ}C$ , $freq<20GHz$	Spurious: -60dBm max. No return gain			

## ■ELECTRICAL CHARACTERISTICS 4 (1.8GHz Band, High Gain version)

( $V_{DD}=2.8V$ ,  $f=1860MHz$ ,  $T_a=+25^{\circ}C$ ,  $Z_s=Z_l=50\Omega$ , with application circuit)

PARAMETER	SYMBOL	CONDITIONS	MIN	TYP	MAX	UNITS
Operating Frequency	Freq		1840	1860	1870	MHz
Drain Voltage	$V_{DD}$		2.7	2.8	5.5	V
Operating Current	$I_{DD}$	RF OFF	-	7.0	8.5	mA
Small Signal Gain	Gain		18.0	20.0	22.0	dB
Gain Flatness	$G_{flat}$	$f=1840\sim 1870MHz$	-	0.5	1.0	dB
Noise Figure	NF		-	1.9	2.2	dB
Pout at 1dB Gain Compression point	$P_{-1dB}$		+1.0	+4.0	-	dBm
Input 3rd Order Intercept Point	IIP3	$f=1860.0+1860.1MHz$ , $P_{in}=-35dBm$	-7.5	-4.5	-	dBm
LNAIN Port VSWR	$VSWR_i$		-	1.5	2.0	
LNAOUT Port VSWR	$VSWR_o$		-	1.5	2.0	
Stability		IN/OUT terminal: open or short, No RF input, $T_a=20\sim 80^{\circ}C$ , $freq<20GHz$	Spurious: -60dBm max. No return gain			

# NJG1105F

## ■ELECTRICAL CHARACTERISTICS 5 (1.9GHz Band, High Gain version)

( $V_{DD}=2.8V$ ,  $f=1960MHz$ ,  $T_a=+25^{\circ}C$ ,  $Z_s=Z_l=50\Omega$ , with application circuit)

PARAMETER	SYMBOL	CONDITIONS	MIN	TYP	MAX	UNITS
Operating Frequency	Freq		1930	1960	1990	MHz
Drain Voltage	$V_{DD}$		2.7	2.8	5.5	V
Operating Current	$I_{DD}$	RF OFF	-	7.0	8.5	mA
Small Signal Gain	Gain		17.5	19.5	21.5	dB
Gain Flatness	$G_{flat}$	$f=1930\sim 1990MHz$	-	0.8	1.1	dB
Noise Figure	NF		-	1.9	2.2	dB
Pout at 1dB Gain Compression point	$P_{-1dB}$		+1.0	+4.0	-	dBm
Input 3rd Order Intercept Point	IIP3	$f=1960.0+1960.1MHz$ Pin=-35dBm	-8.5	-4.5	-	dBm
LNAIN Port VSWR	$VSWR_i$		-	1.5	2.0	
LNAOUT Port VSWR	$VSWR_o$		-	2.0	3.0	
Stability		IN/OUT terminal: open or short, No RF input, $T_a=20\sim 80^{\circ}C$ , $freq<20GHz$	Spurious: -60dBm max. No return gain			

## ■ELECTRICAL CHARACTERISTICS 6 (2.1GHz Band, High Gain version 1)

( $V_{DD}=2.8V$ ,  $f=2140MHz$ ,  $T_a=+25^{\circ}C$ ,  $Z_s=Z_l=50\Omega$ , with application circuit)

PARAMETER	SYMBOL	CONDITIONS	MIN	TYP	MAX	UNITS
Operating Frequency	Freq		2110	2140	2170	MHz
Drain Voltage	$V_{DD}$		2.7	2.8	5.5	V
Operating Current	$I_{DD}$	RF OFF	-	7.0	8.5	mA
Small Signal Gain	Gain		13.0	15.0	17.0	dB
Gain Flatness	$G_{flat}$	$f=2110\sim 2140MHz$	-	0.5	1.0	dB
Noise Figure	NF		-	1.7	1.9	dB
Pout at 1dB Gain Compression point	$P_{-1dB}$		0.0	+3.0	-	dBm
Input 3rd Order Intercept Point	IIP3	$f=2140.0+2140.1MHz$ , Pin=-35dBm	-6.5	-3.5	-	dBm
LNAIN Port VSWR	$VSWR_i$		-	2.0	2.5	
LNAOUT Port VSWR	$VSWR_o$		-	1.5	2.0	
Stability		IN/OUT terminal: open or short, No RF input, $T_a=20\sim 80^{\circ}C$ , $freq<20GHz$	Spurious: -60dBm max. No return gain			

**■ ELECTRICAL CHARACTERISTICS 7 (2.1GHz Band, High Gain version 2)**

( $V_{DD}=2.8V$ ,  $f=2140MHz$ ,  $T_a=+25^{\circ}C$ ,  $Z_s=Z_l=50\Omega$ , with application circuit)

PARAMETER	SYMBOL	CONDITIONS	MIN	TYP	MAX	UNITS
Operating Frequency	Freq		2110	2140	2170	MHz
Drain Voltage	$V_{DD}$		2.7	2.8	5.5	V
Operating Current	$I_{DD}$	RF OFF	-	7.0	8.5	mA
Small Signal Gain	Gain		15.0	17.0	19.0	dB
Gain Flatness	$G_{flat}$	$f=2110\sim 2140MHz$	-	0.5	1.0	dB
Noise Figure	NF		-	1.7	1.9	dB
Pout at 1dB Gain Compression point	$P_{-1dB}$		+1.0	+4.0	-	dBm
Input 3rd Order Intercept Point	IIP3	$f=2140.0+2140.1MHz$ , $P_{in}=-35dBm$	-5.5	-2.5	-	dBm
LNAIN Port VSWR	$VSWR_i$		-	2.0	2.5	
LNAOUT Port VSWR	$VSWR_o$		-	1.5	2.0	
Stability		IN/OUT terminal: open or short, No RF input, $T_a=20\sim 80^{\circ}C$ , $freq<20GHz$	Spurious: -60dBm max. No return gain			

# NJG1105F

---

## ■TERMINAL INFORMATION

Pin	Function	Description
1	VDD	Bias voltage supply terminal for 1 <sup>st</sup> stage amplifier. Optimized value of inductor L4 is required because it works as matching element. (Please refer to "RECOMMENDED CIRCUIT")
2,5	GND	Ground pin (0V).
3	RFout	RF output and voltage supply pin of 2 <sup>nd</sup> stage amplifier. External matching circuits and a bypass capacitor is required. Inductors C4, L3 work as external output matching elements. (Please refer to "RECOMMENDED CIRCUIT")
4	RFin	RF input pin. No DC blocking capacitor is required, but an external matching circuit is required. (Please refer to "RECOMMENDED CIRCUIT")
6	EXTCAP	An external bypass capacitor is required. This capacitor works as external matching element. (Please refer to "RECOMMENDED CIRCUIT")

## TYPICAL CHARACTERISTICS (1.8GHz BAND)

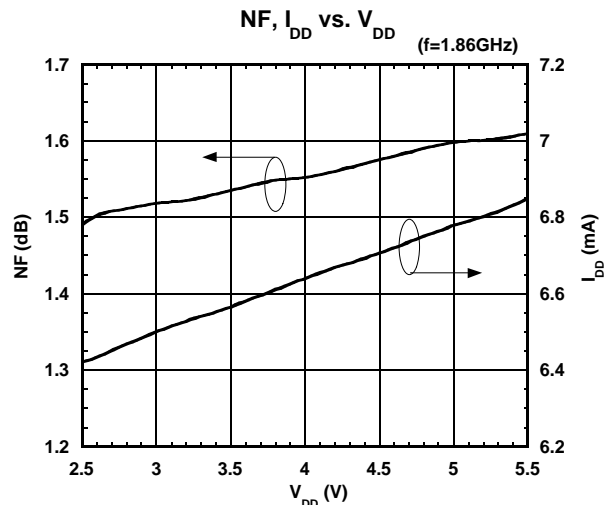
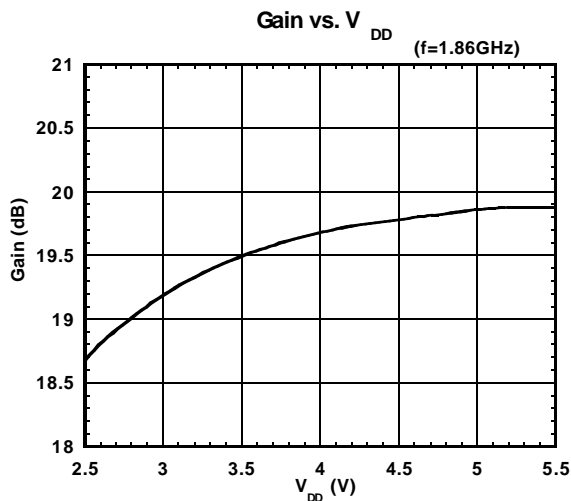
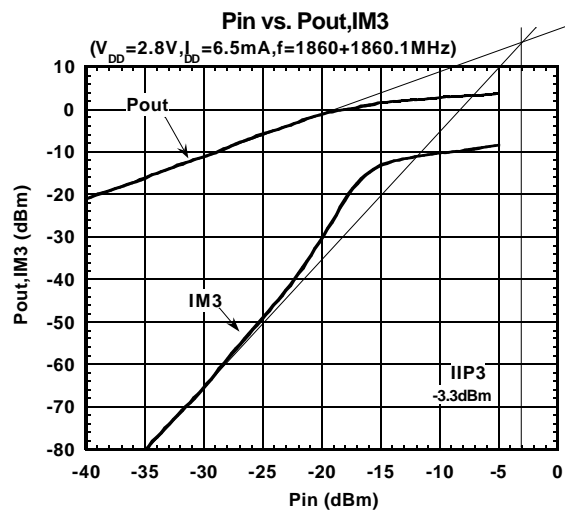
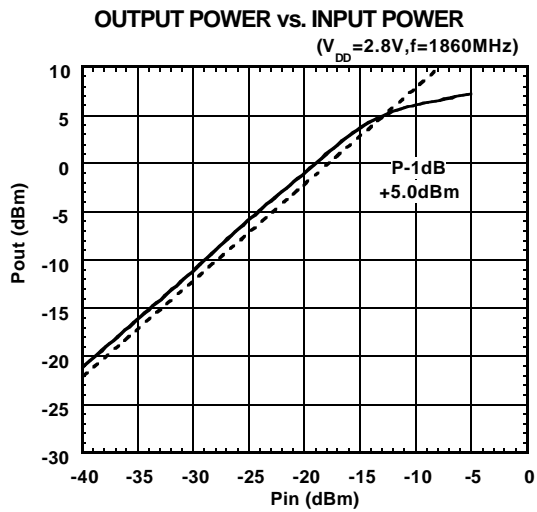
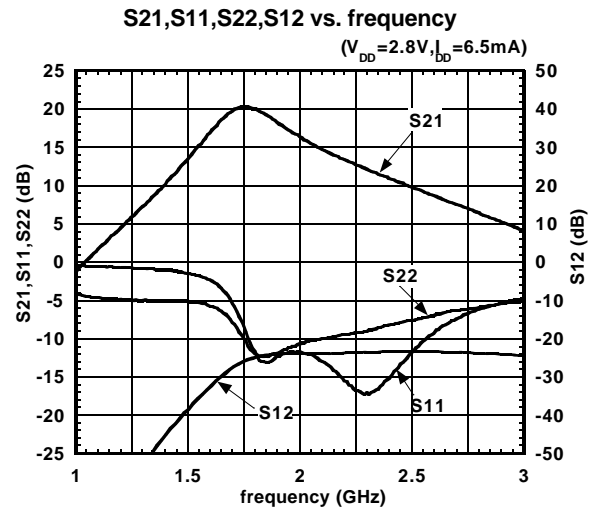
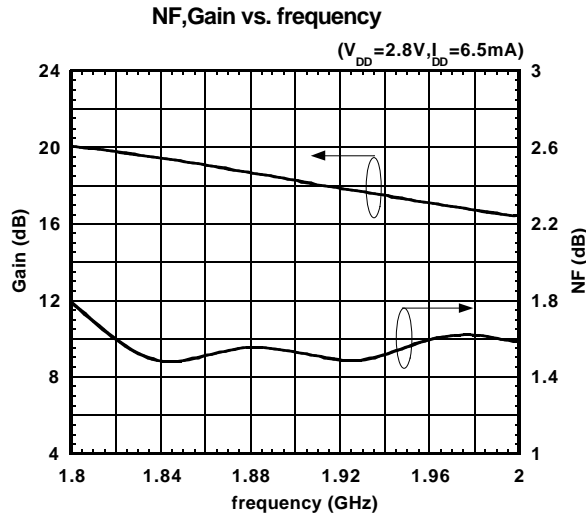

# NJG1105F

## ■ TYPICAL CHARACTERISTICS (1.8GHz BAND)

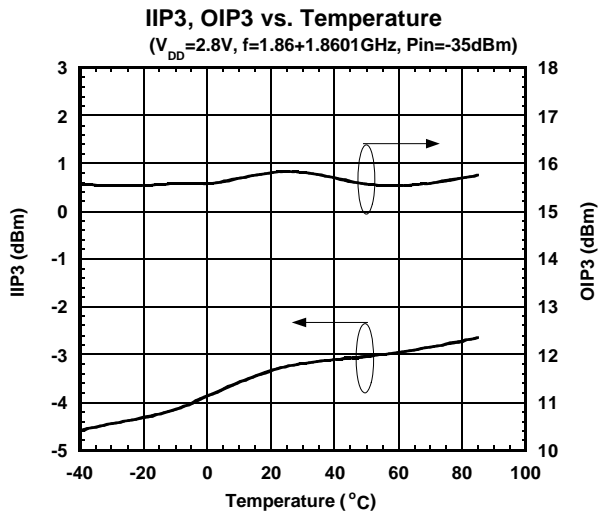
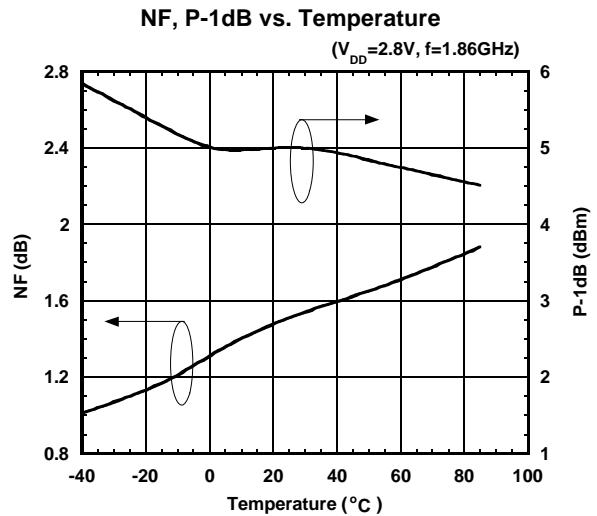
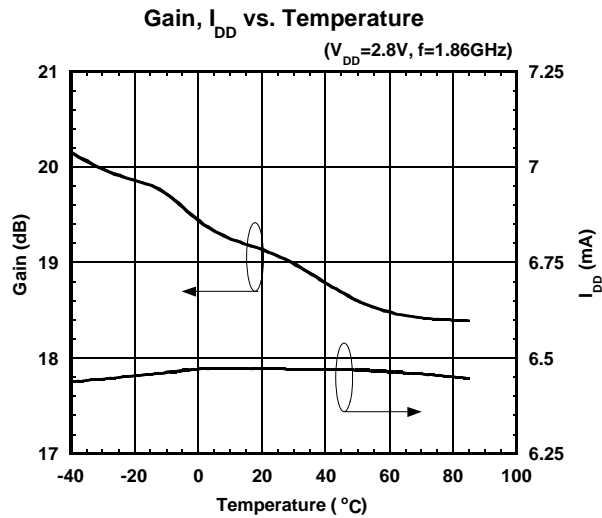
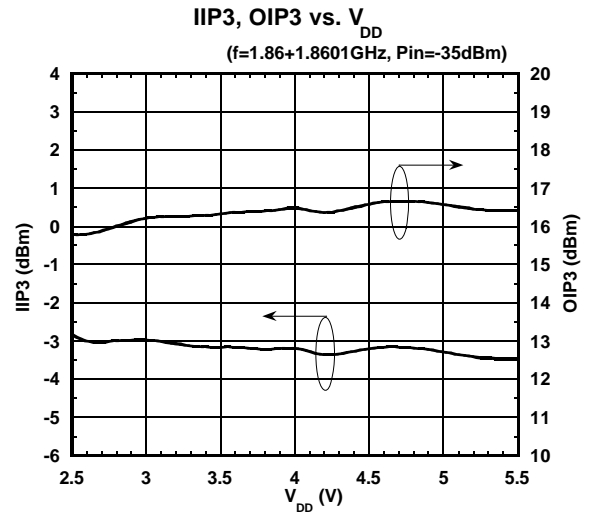
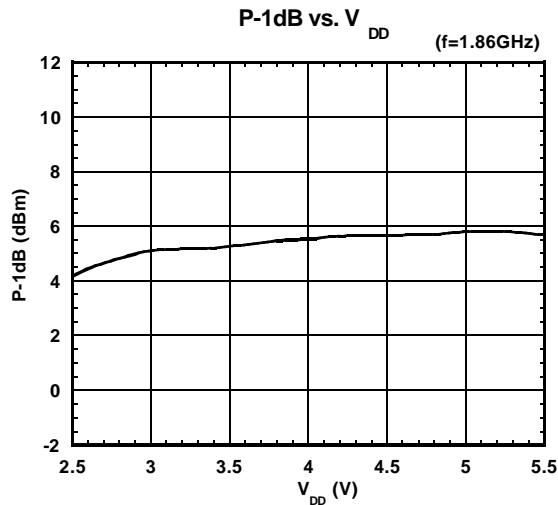

Equations of OIP3 and IIP3

$$OIP3 = \frac{3 \times P_{out} - IM3}{2}$$

$$IIP3 = OIP3 - Gain \quad @ \text{ Pin} = -40\text{dBm}$$



■ TYPICAL CHARACTERISTICS (1.8GHz BAND)

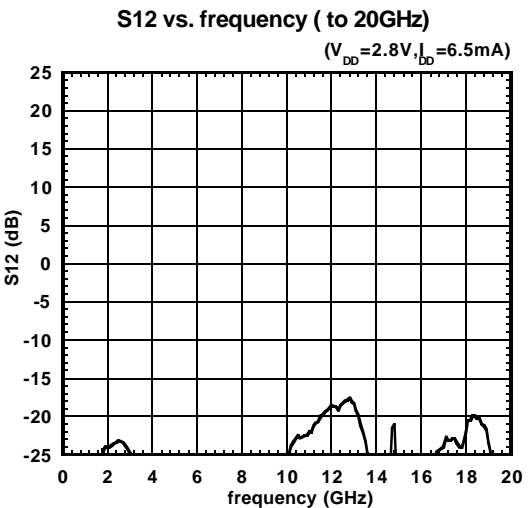
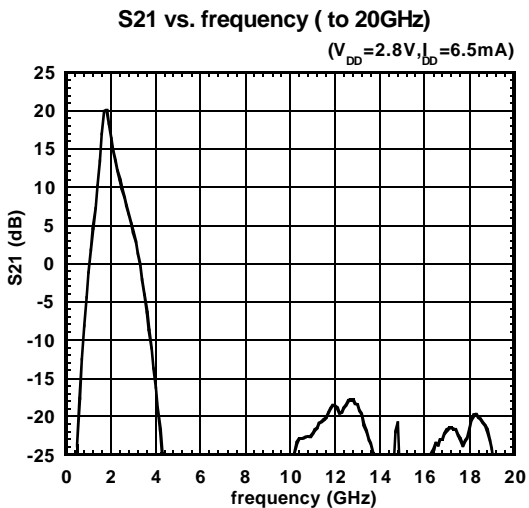
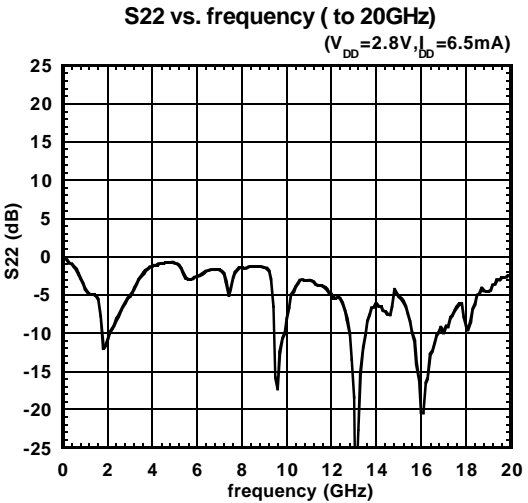
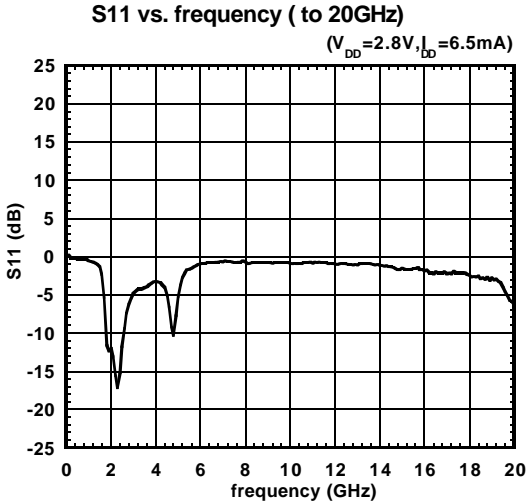

Downloaded from [Elcodis.com](http://Elcodis.com) electronic components distributor

# NJG1105F

## ■ TYPICAL CHARACTERISTICS (1.9GHz BAND)

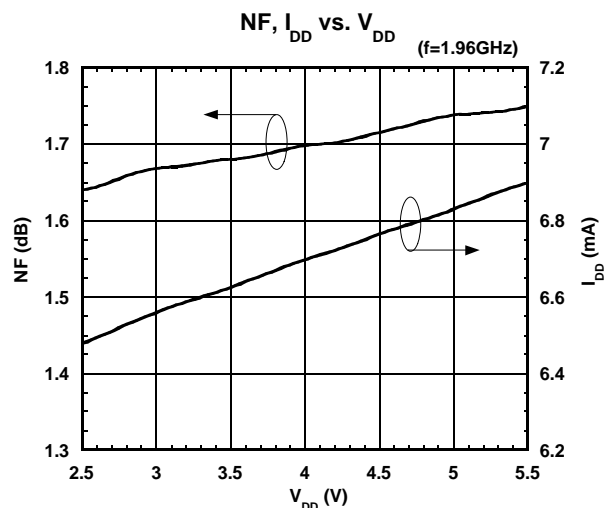
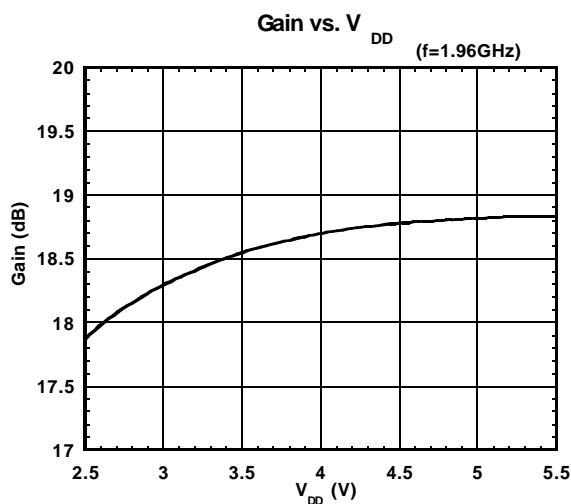
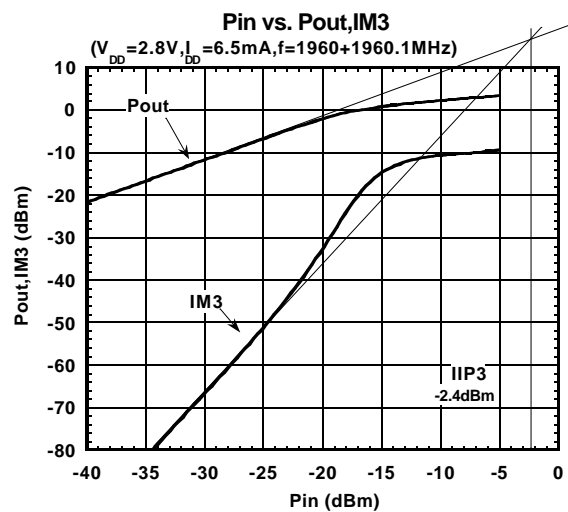
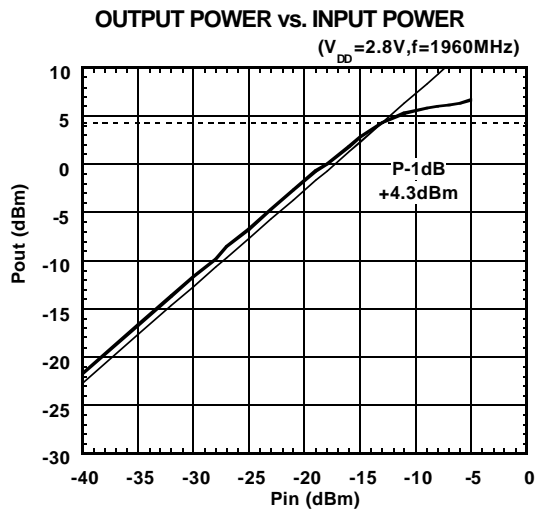
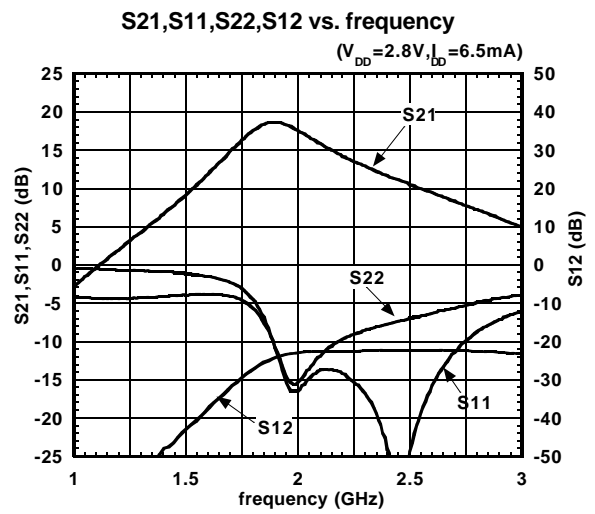
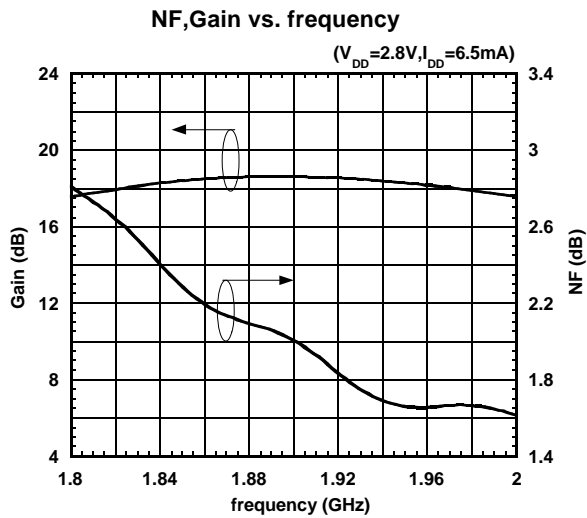

## TYPICAL CHARACTERISTICS (1.9GHz BAND)

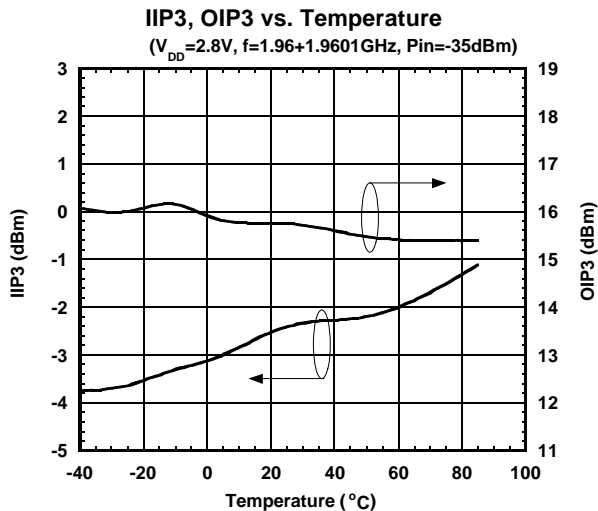
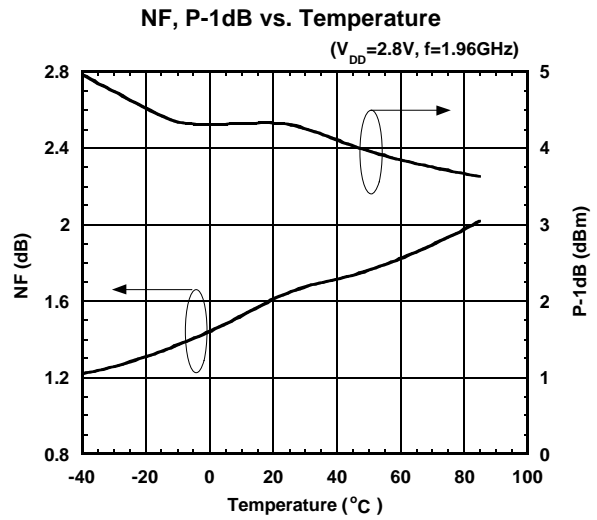
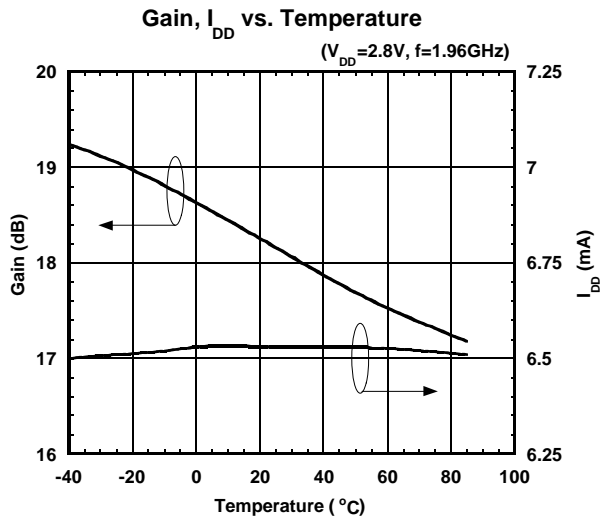
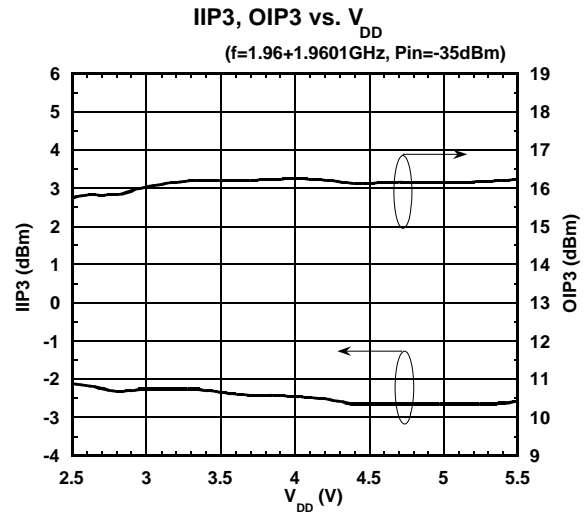
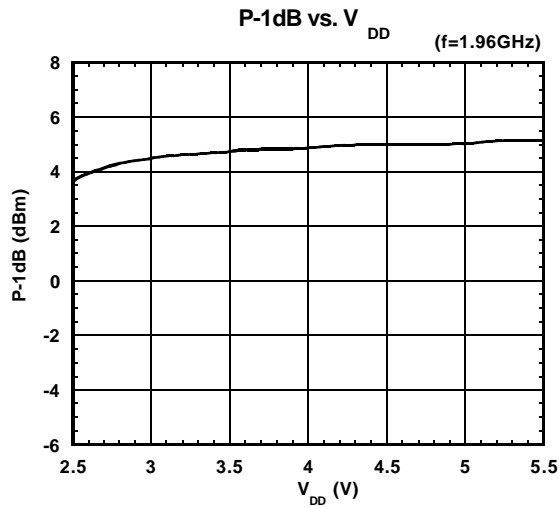

Equations of OIP3 and IIP3

$$OIP3 = \frac{3 \times P_{out} - IM3}{2}$$

$$IIP3 = OIP3 - \text{Gain} \quad @ \text{ Pin} = -40\text{dBm}$$

# NJG1105F

## ■ TYPICAL CHARACTERISTICS (1.9GHz BAND)

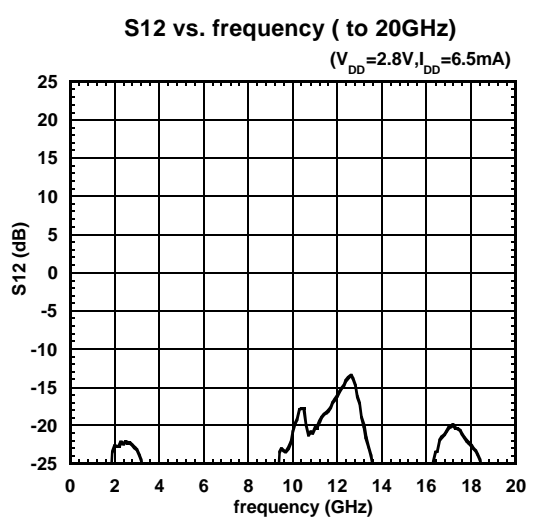
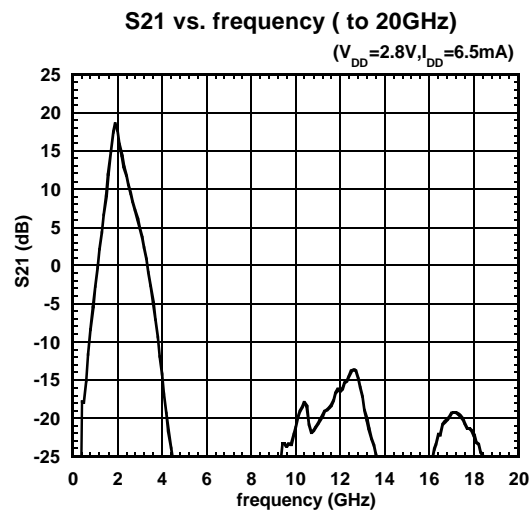
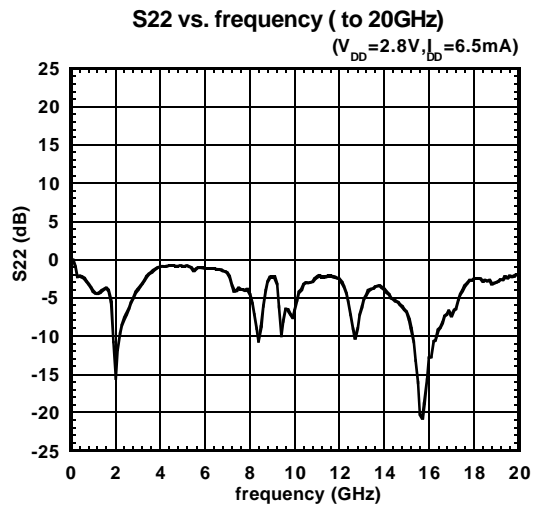
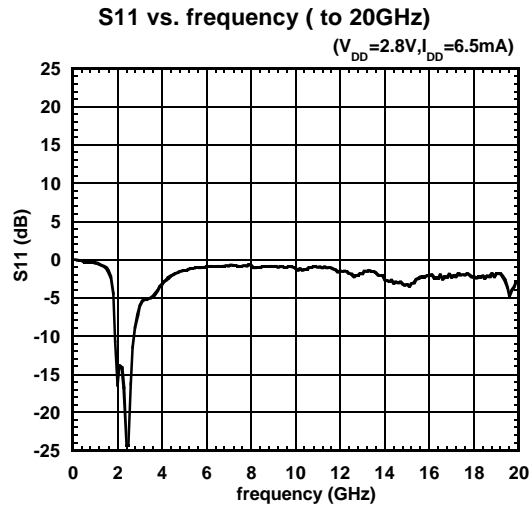

## TYPICAL CHARACTERISTICS (2.1GHz BAND)

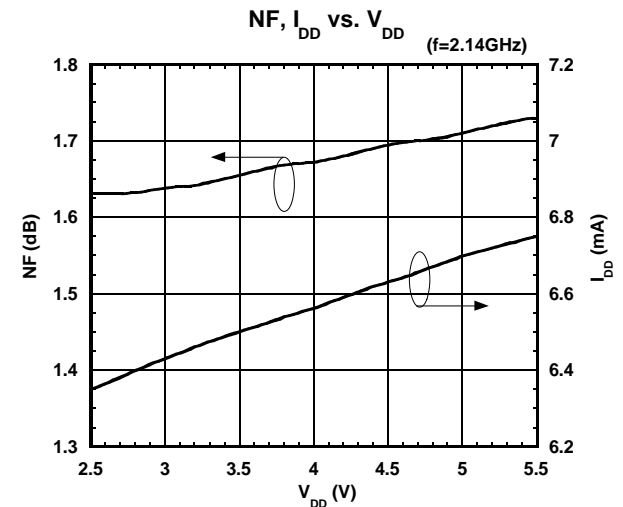
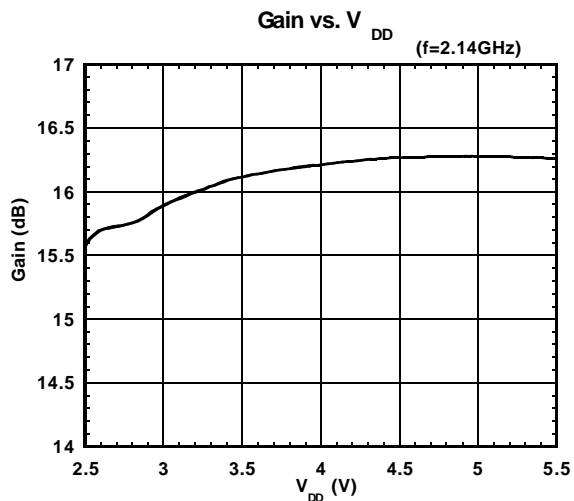
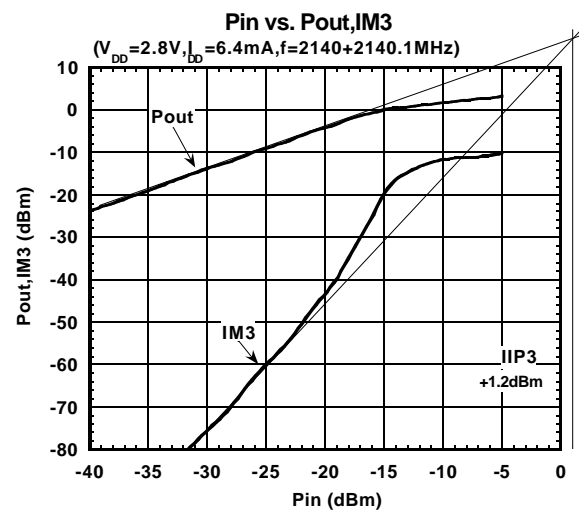
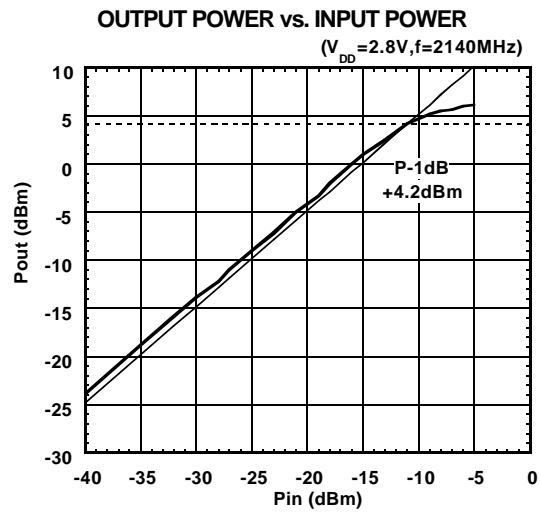
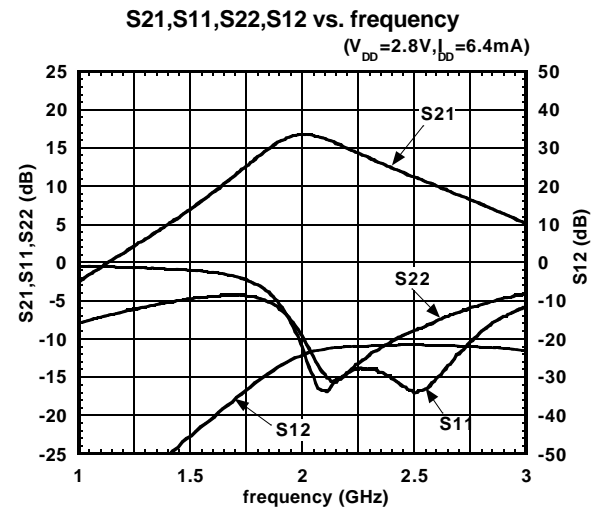
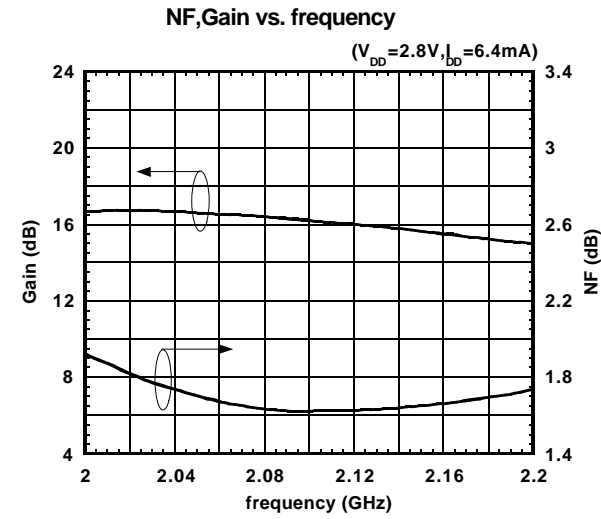

# NJG1105F

## ■ TYPICAL CHARACTERISTICS (2.1GHz BAND)

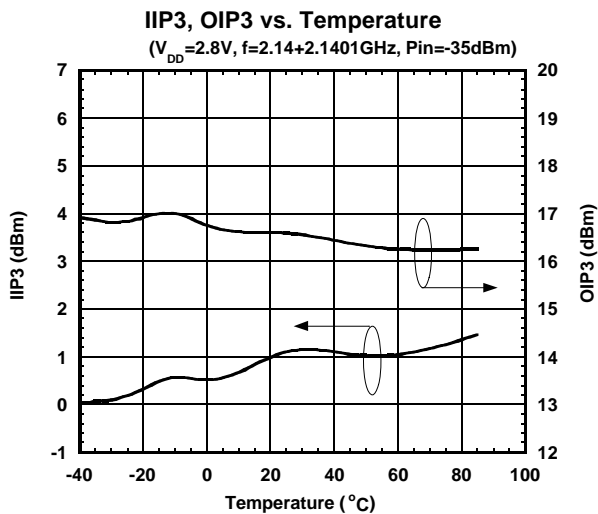
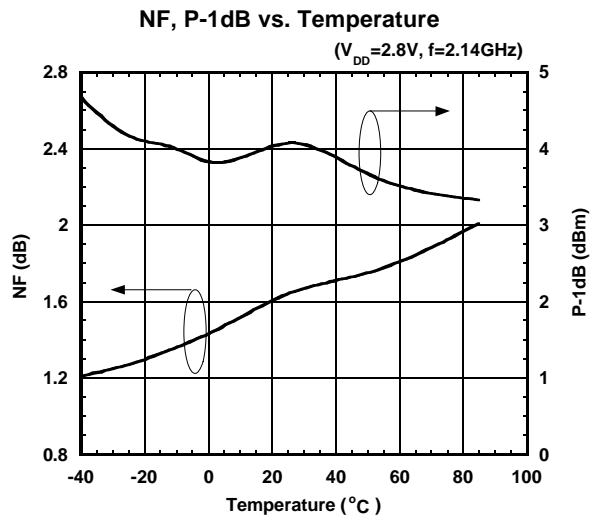
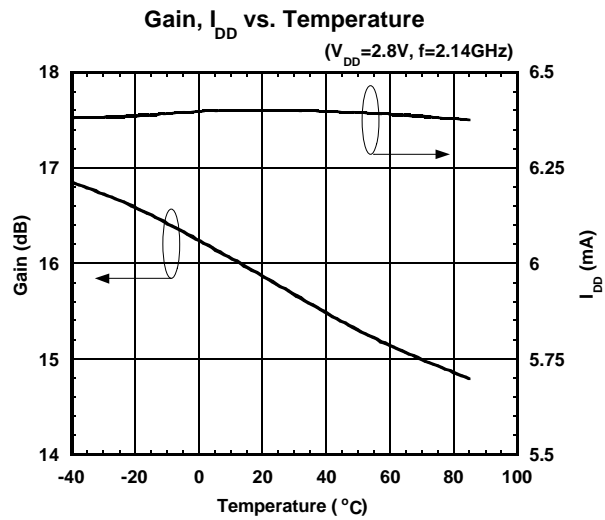
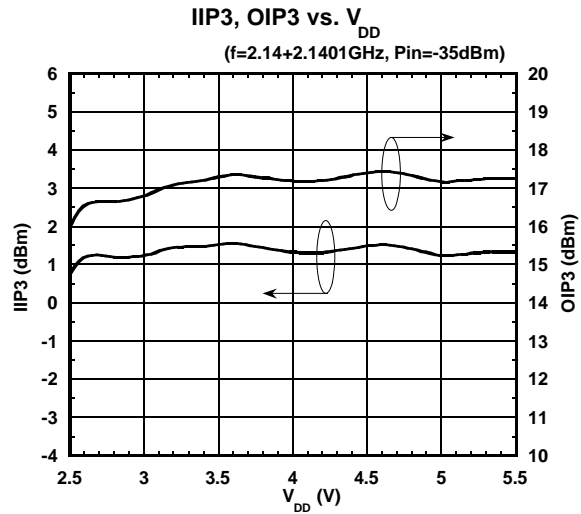
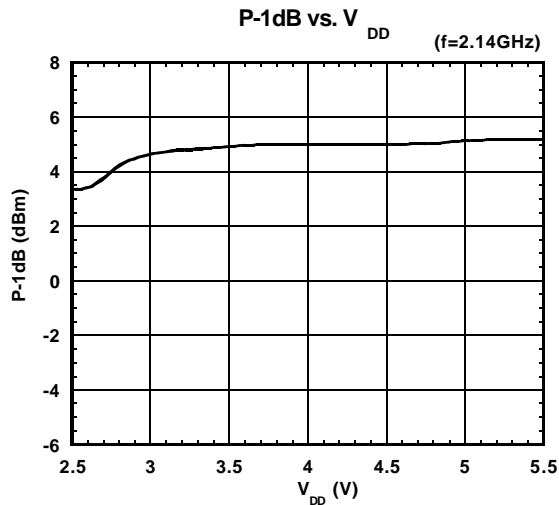

Equations of OIP3 and IIP3

$$OIP3 = \frac{3 \times P_{out} - IM3}{2}$$

$$IIP3 = OIP3 - \text{Gain} \quad @ \text{ Pin} = -40\text{dBm}$$

## ■ TYPICAL CHARACTERISTICS (2.1GHz BAND)

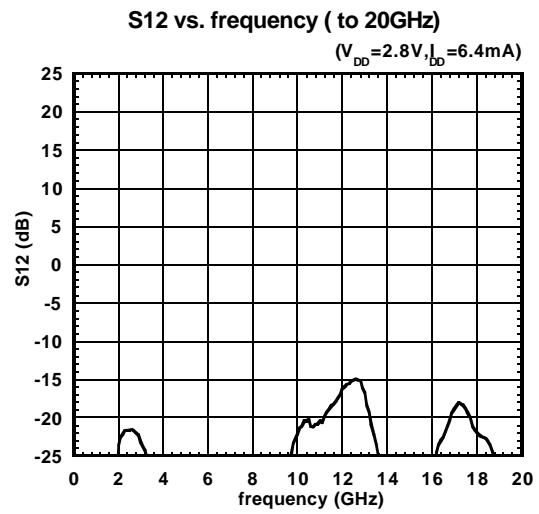
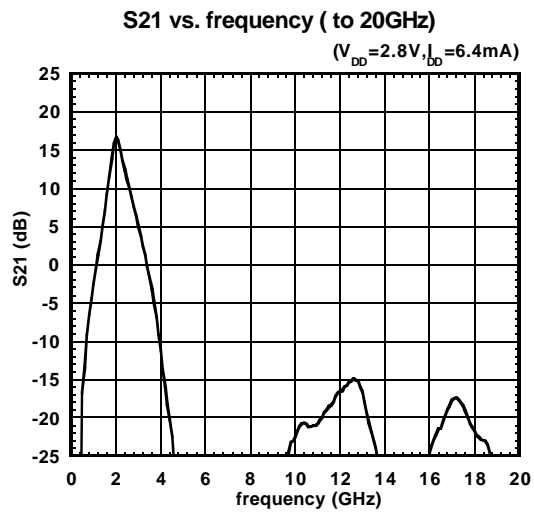
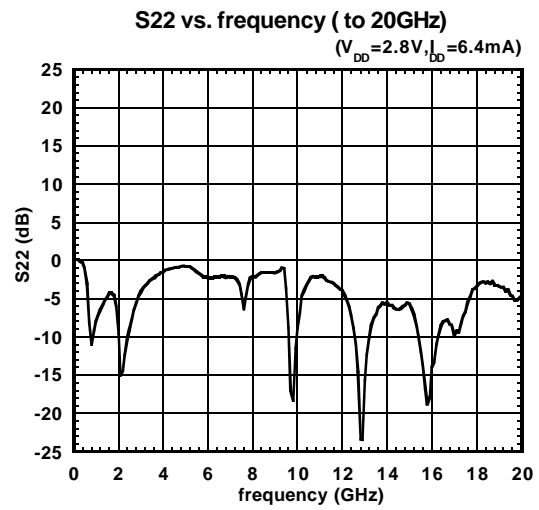
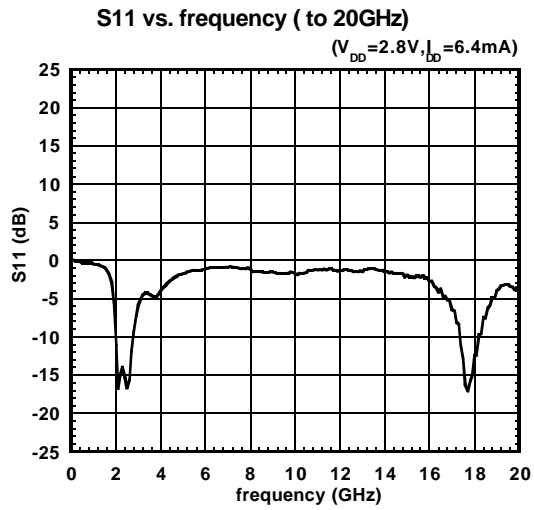

# NJG1105F

## ■ TYPICAL CHARACTERISTICS (1.8GHz BAND: High Gain version)

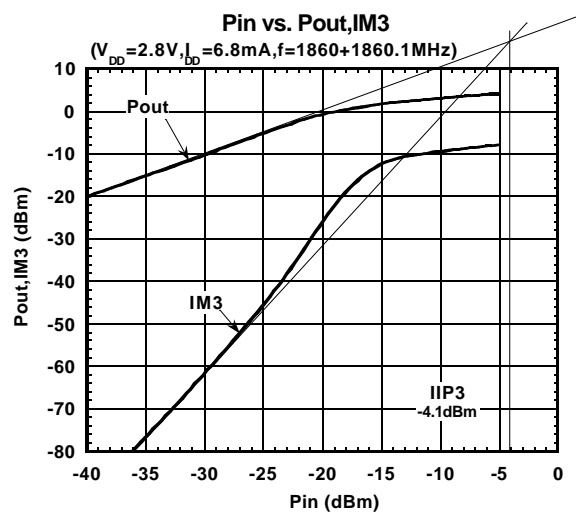
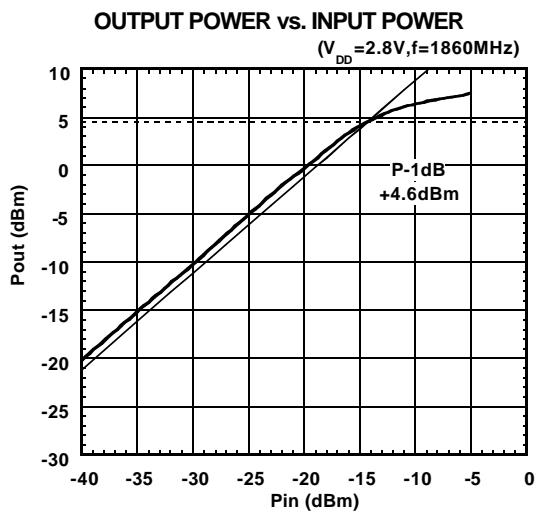
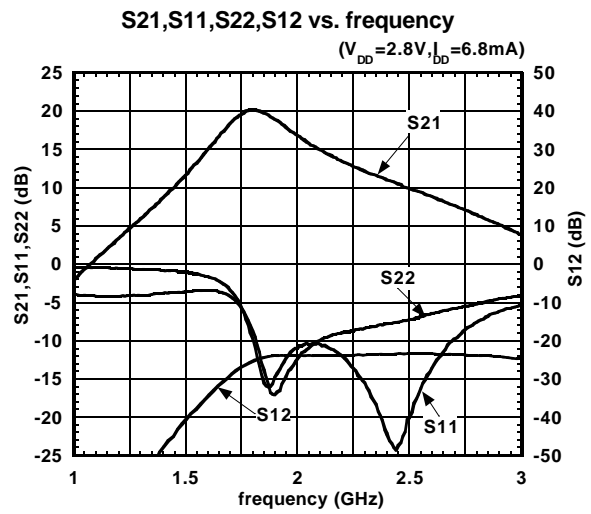
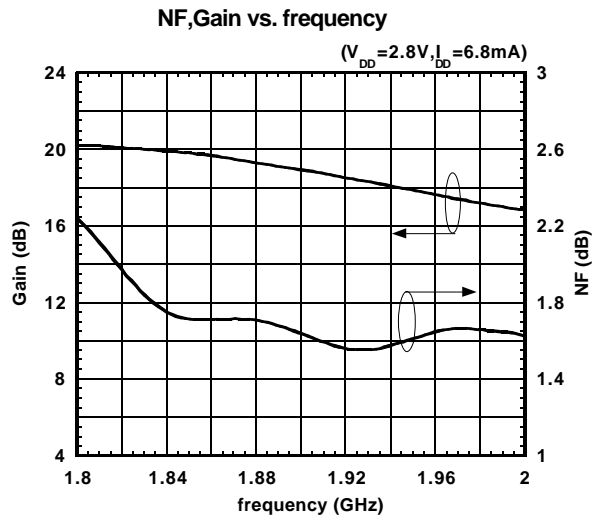



## ■ TYPICAL CHARACTERISTICS (1.9GHz BAND: High Gain version)

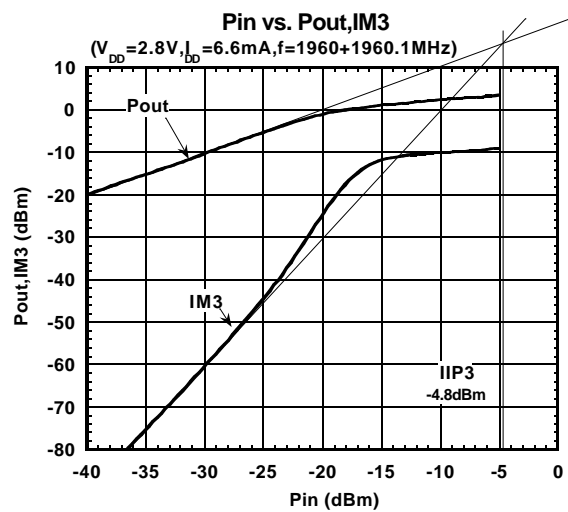
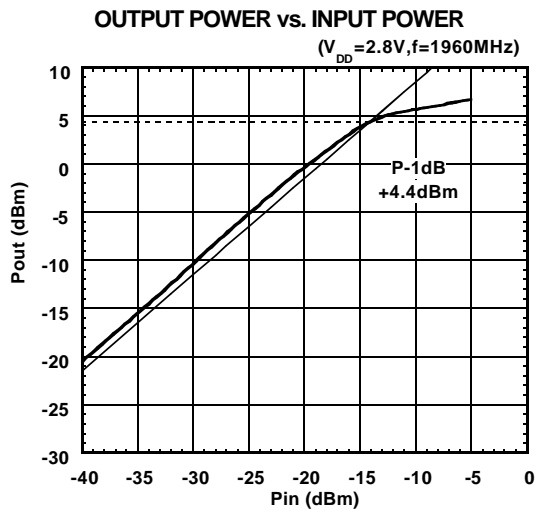
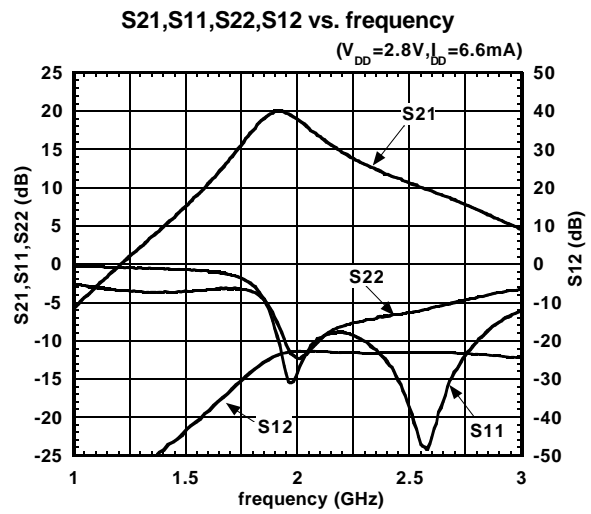
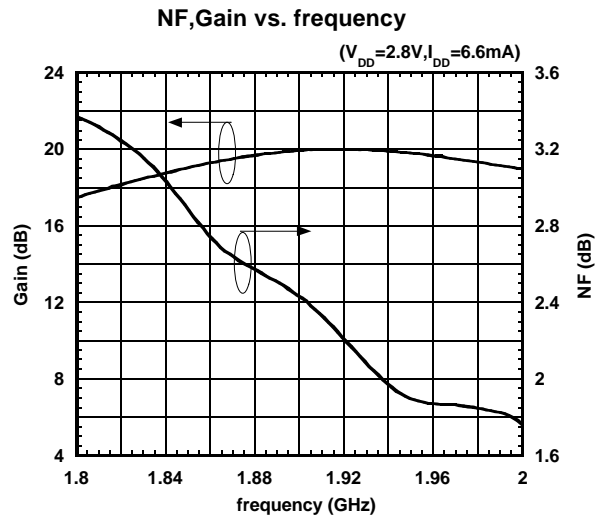

# NJG1105F

## ■ TYPICAL CHARACTERISTICS (2.1GHz BAND: High Gain version 1)

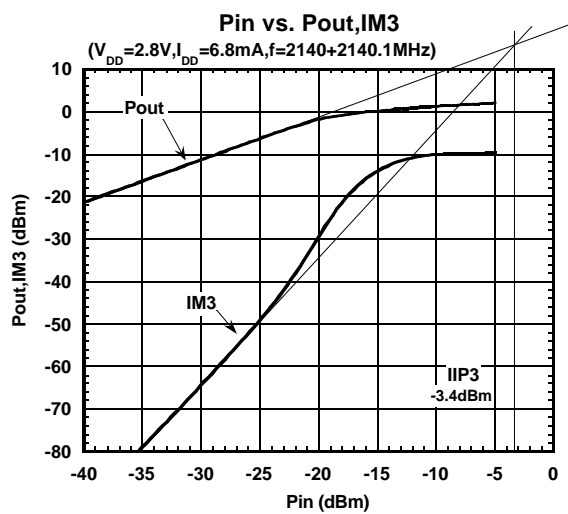
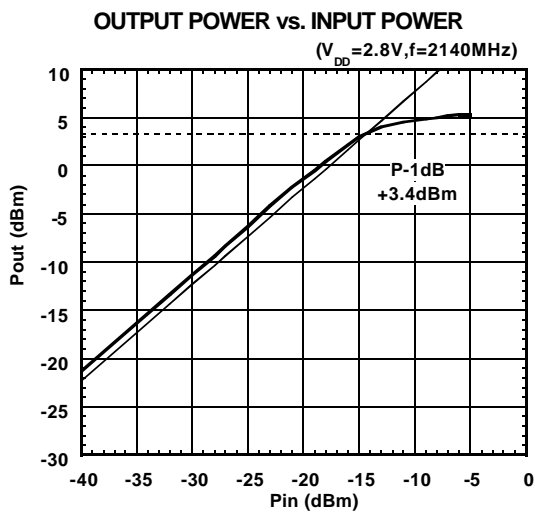
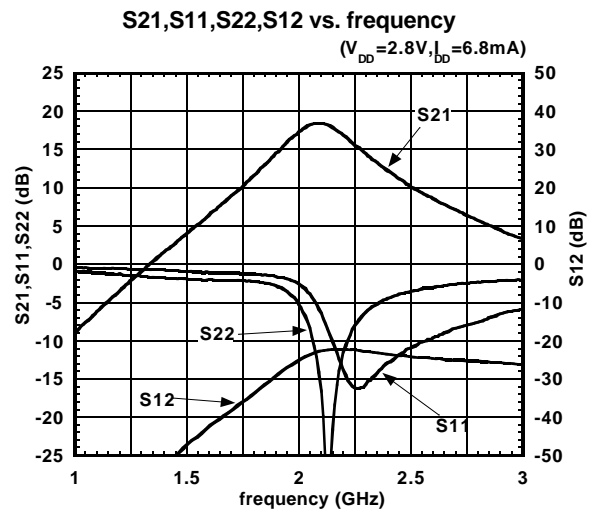
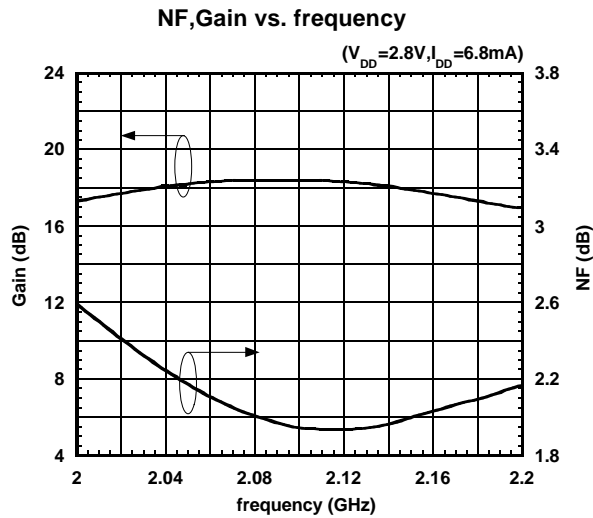

RECOMMENDED CIRCUIT

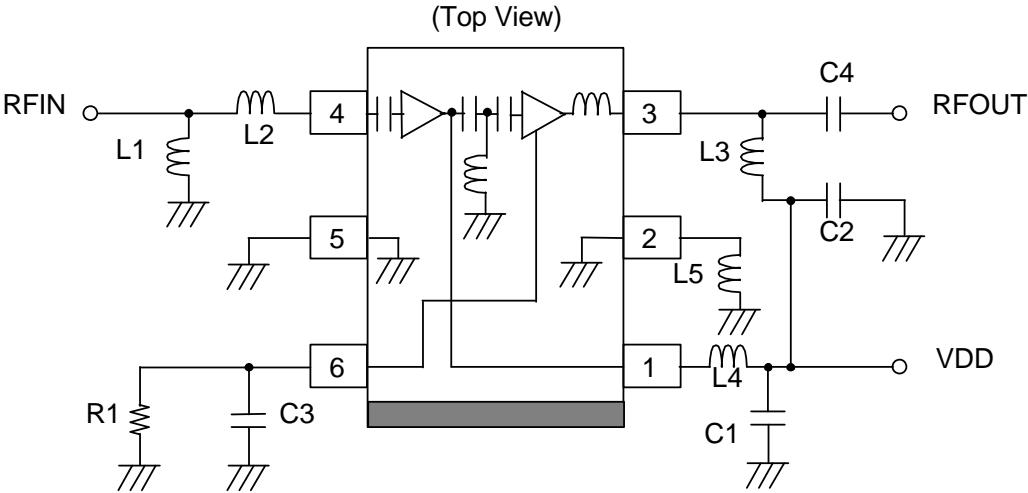

# NJG1105F

## RECOMMENDED PCB DESIGN

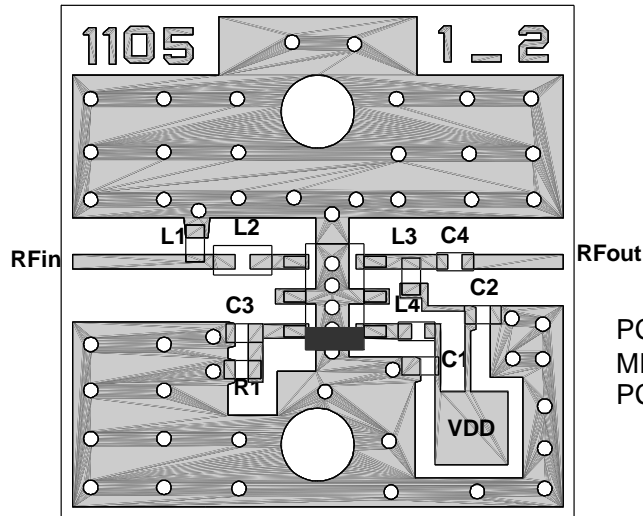

PCB: FR4 t=0.2mm  
 MICROSTRIP LINE WIDTH=0.4mm( $Z_0=50\Omega$ )  
 PCB SIZE: 14.0 x 14.0mm

Table 1 PARTS LIST 1

Parts ID	Constant			Comment
	1.8GHz Band	1.9GHz Band	2.1GHz Band	
L1	3.9nH	3.3nH	3.3nH	TAIYO-YUDEN (HK1005)
L2	3.9nH	3.3nH	3.3nH	TAIYO-YUDEN (HK1608)
L3	12nH	27nH	12nH	TAIYO-YUDEN (HK1005)
L4	68nH	22nH	12nH	TAIYO-YUDEN (HK1005)
C1	0.01uF	0.01uF	0.01uF	Murata (GRM36)
C2	0.01uF	0.01uF	0.01uF	Murata (GRM36)
C3	4pF	4pF	4pF	Murata (GRM36)
C4	39pF	13pF	3pF	Murata (GRM36)
R1	330 $\Omega$	330 $\Omega$	330 $\Omega$	1005 Size

Table 2 PARTS LIST 2 (High Gain version)

Parts ID	Constant				Comment
	1.8GHz Band	1.9GHz Band	2.1GHz Band 1	2.1GHz Band 2	
L1	3.3nH	2.7nH	3.9nH	3.3nH	TAIYO-YUDEN (HK1005)
L2	3.9nH	3.3nH	1.5nH	2.7nH	TAIYO-YUDEN (HK1608)
L3	39nH	68nH	100nH	39nH	TAIYO-YUDEN (HK1005)
L4	68nH	22nH	15nH	8.2nH	TAIYO-YUDEN (HK1005)
C1	0.01uF	0.01uF	0.01uF	0.01uF	Murata (GRM36)
C2	0.01uF	0.01uF	0.01uF	0.01uF	Murata (GRM36)
C3	4pF	3pF	2pF	2pF	Murata (GRM36)
C4	16pF	8pF	1.5pF	5pF	Murata (GRM36)
R1	330 $\Omega$	330 $\Omega$	330 $\Omega$	330 $\Omega$	1005 Size

## PACKAGE OUTLINE (MTP6)

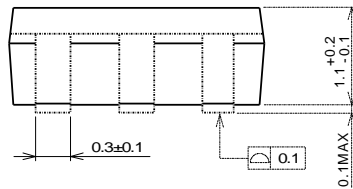
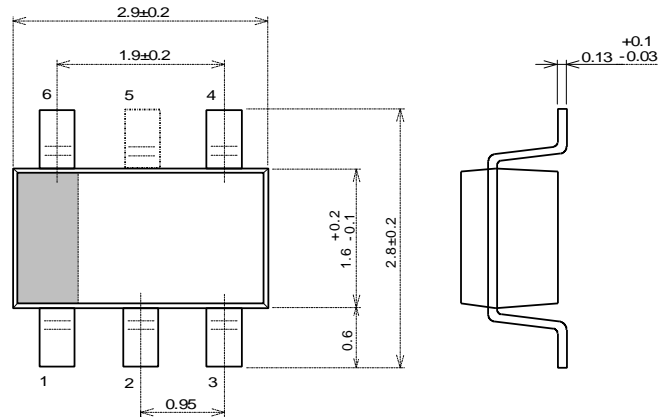

Lead material : Copper  
 Lead surface finish: Solder plating  
 Molding material : Epoxy resin  
 Unit : mm  
 Weight : 14mg

### Cautions on using this product

This product contains Gallium-Arsenide (GaAs) which is a harmful material.

- Do NOT eat or put into mouth.
- Do NOT dispose in fire or break up this product.
- Do NOT chemically make gas or powder with this product.
- To waste this product, please obey the relating law of your country.

### [CAUTION]

The specifications on this databook are only given for information, without any guarantee as regards either mistakes or omissions. The application circuits in this databook are described only to show representative usages of the product and not intended for the guarantee or permission of any right including the industrial rights.

This product may be damaged with electric static discharge (ESD) or spike voltage. Please handle with care to avoid these damages.