

SPDT SWITCH GaAs MMIC

■ GENERAL DESCRIPTION

NJG1535HD3 is a GaAs SPDT switch IC suited for antenna switch of cellular phone handset.

This switch features high power, low loss, high isolation and the low switch current.

This device includes logic decoder function, and can be operated by 1 bit control signal for RF port.

The ultra small & ultra thin USB6-D3 package is adopted.

■ PACKAGE OUTLINE

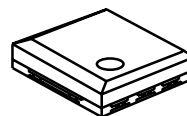

NJG1535HD3

■ FEATURES

- Low voltage operation +2.5~+5.5V
- Pin at 0.2dB compression point 36dBm typ. @f=2GHz, $V_{CTL}=2.7V$
- Low insertion loss 0.3dB typ. @f=1.0GHz, $P_{IN}=30dBm$, $V_{CTL}=2.7V$
- High isolation 28dB typ. @f=1.0GHz, $P_{IN}=30dBm$, $V_{CTL}=2.7V$
- Low current consumption 15uA typ.
- Ultra small & ultra thin package USB6-D3 (Package size: 2.0x1.8x0.8mm)

■ PIN CONFIGURATION

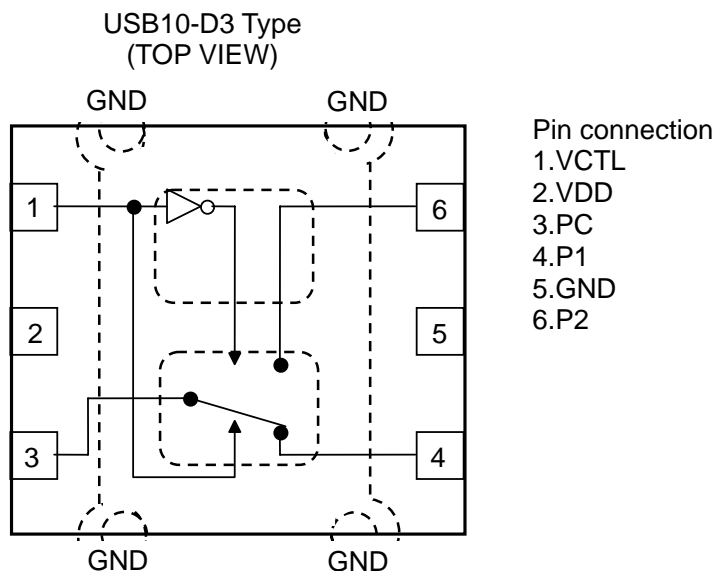

■ TRUTH TABLE

Control Voltage: "H"= $V_{CTL(H)}$, "L"= $V_{CTL(L)}$

VCTL	H	L
PC-P1	ON	OFF
PC-P2	OFF	ON

NOTE: Please note that any information on this catalog will be subject to change.

NJG1535HD3

■ ABSOLUTE MAXIMUM RATINGS

PARAMETER	SYMBOL	CONDITIONS	CONDITIONS	UNITS
RF Input Power	P_{IN}	$V_{DD}=2.7V, V_{CTL}=0V/2.7V$	36	dBm
Supply Voltage	V_{DD}	VDD terminal	7.5	V
Power Dissipation	P_D	At on PCB board	210	mW
Control Voltage	V_{CTL}	VCTL terminal	7.5	V
Operating Temp.	T_{opr}		-40~+85	°C
Storage Temp.	T_{stg}		-55~+150	°C

■ ELECTRICAL CHARACTERISTICS

(General conditions: $T_a=+25^{\circ}C, Z_s=Z_l=50\Omega, V_{CTL(L)}=0V, V_{CTL(H)}=2.7V$)

PARAMETERS	SYMBOL	CONDITIONS	MIN	TYP	MAX	UNITS
Supply Voltage	V_{DD}		2.5	2.7	5.5	V
Operating Current	I_{DD}	$P_{IN}=30dBm$	-	70	100	uA
Control Voltage (LOW)	$V_{CTL(L)}$		0	-	0.8	V
Control Voltage (HIGH)	$V_{CTL(H)}$		2.0	2.7	V_{DD}	V
Control Current	I_{CTL}		-	15	30	uA
Insertion Loss 1	LOSS1	$f=1GHz, P_{IN}=30dBm$	-	0.3	0.45	dB
Insertion Loss 2	LOSS2	$f=2GHz, P_{IN}=30dBm$	-	0.4	0.5	dB
Isolation 1	ISL1	$f=1GHz, P_{IN}=30dBm$	26	28	-	dB
Isolation 2	ISL2	$f=2GHz, P_{IN}=30dBm$	23	25	-	dB
Pin at 0.2dB Compression Point	$P_{-0.2dB}$	$f=2GHz$	34	36	-	dBm
2nd Harmonics 1	$2fo(1)$	$f=1GHz, P_{IN}=26dBm$	-	-70	-65	dBc
2nd Harmonics 2	$2fo(2)$	$f=2GHz, P_{IN}=26dBm$	-	-75	-70	dBc
3rd Harmonics 1	$3fo(1)$	$f=1GHz, P_{IN}=26dBm$	-	-75	-65	dBc
3rd Harmonics 2	$3fo(2)$	$f=2.0GHz, P_{IN}=25dBm$	-	-70	-65	dBc
Input 3rd order intercept Point 1	IIP3(1)	$f=1000+1001MHz, P_{in}=26dBm$ *1	58	62	-	dBm
Input 3rd order intercept Point 2	IIP3(2)	$f=2000+2001MHz, P_{in}=26dBm$ *1	56	60	-	dBm
VSWR	VSWR	$f=0.1\sim 2.5GHz, ON State$	-	1.2	1.4	
Switching time	T_{SW}	$f=0.1\sim 2GHz$	-	0.8	-	us

*1: The input IP3 is defined as following equation.

$$IIP3 = (3 \times P_{out} - IM3) / 2 + LOSS$$

■ TERMINAL INFORMATION

No.	SYMBOL	DESCRIPTION
1	VCTL	Control signal input terminal. This terminal is set to High-Level (+2V~VDD) or Low-Level (0~+0.8V).
2	VDD	Positive voltage supply terminal. The positive voltage (+2.5~+5.5V) have to be supplied. Please connect a bypass capacitor with GND terminal for excellent RF performance.
3	PC	Common RF port. The terminal PC is connected with the terminal P1 or the terminal P2 by the voltage impressed to the terminal VCTL. In order to block the DC bias voltage of internal circuit, an external capacitor is required. (50~100MHz:0.01uF, 0.1~0.5GHz: 1000pF, 0.5~2.5GHz: 56pF).
4	P1	RF port. This port is connected with PC port by controlling 6 th pin ($V_{CTL(H)}$) to 2.0~VDD. An external capacitor is required to block the DC bias voltage of internal circuit. (50~100MHz:0.01uF, 0.1~0.5GHz: 1000pF, 0.5~2.5GHz: 56pF)
5	GND	Ground terminal. Please connect this terminal with ground plane as close as possible for excellent RF performance.
6	P2	RF port. This port is connected with PC port by controlling 6 th pin ($V_{CTL(H)}$) to 0~+0.8. An external capacitor is required to block the DC bias voltage of internal circuit. (50~100MHz:0.01uF, 0.1~0.5GHz: 1000pF, 0.5~2.5GHz: 56pF)

NJG1535HD3

ELECTRICAL CHARACTERISTICS

(0.1~3.0GHz, with application circuit, Losses of external circuit are excluded)

PC-P1 Insetion Loss vs. Frequency
(VDD=2.7V, VCTL=2.7V)

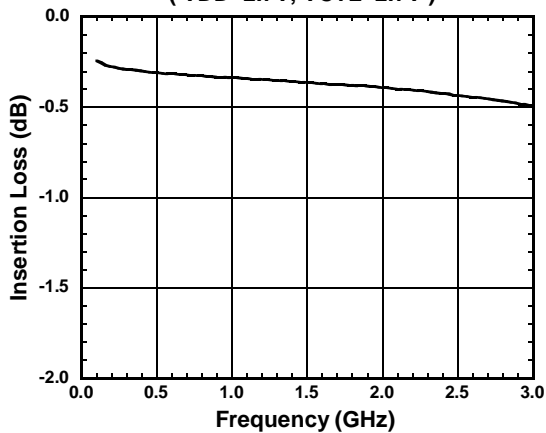

PC-P2 Insetion Loss vs. Frequency
(VDD=2.7V, VCTL=0V)

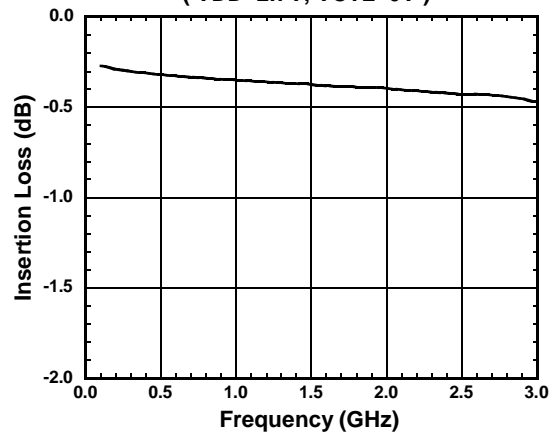

PC-P1 Isolation vs. Frequency
(VDD=2.7V, VCTL=0V)

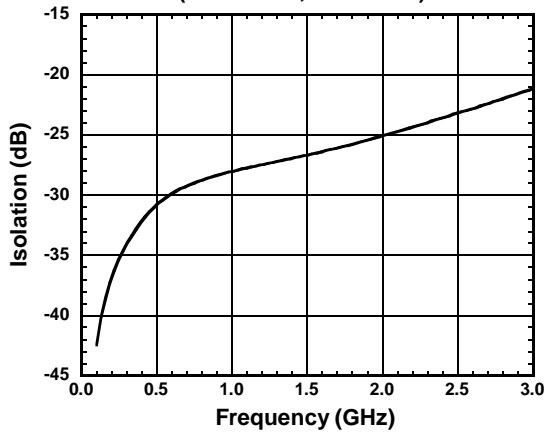

PC-P2 Isolation vs. Frequency
(VDD=2.7V, VCTL=2.7V)

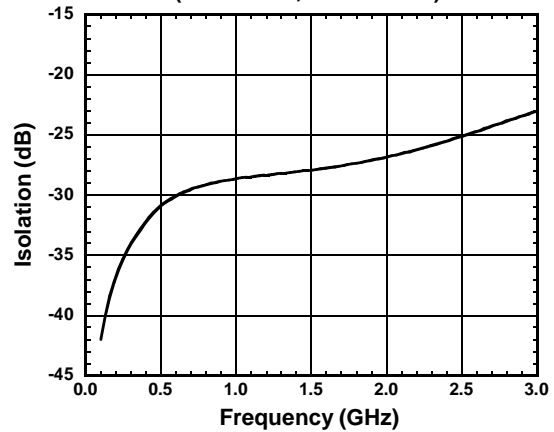

PC-P1 VSWR vs. Frequency
(VDD=2.7V, VCTL=2.7V, P1port)

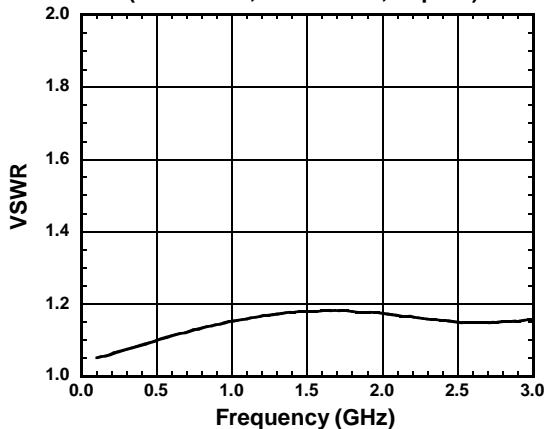

PC-P2 VSWR vs. Frequency
(VDD=2.7V, VCTL=0V, P2port)

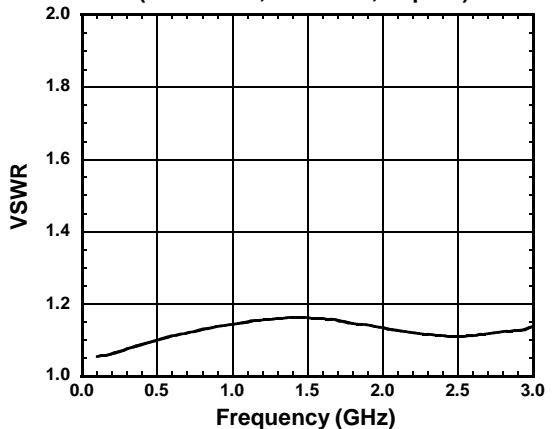

ELECTRICAL CHARACTERISTICS

(Application circuit (Parts list 3), Losses of PCB, connector and DC blocking capacitor are included)

Insertion Loss, Current IDD vs. Input Power

(PC-P1on, f=1GHz)

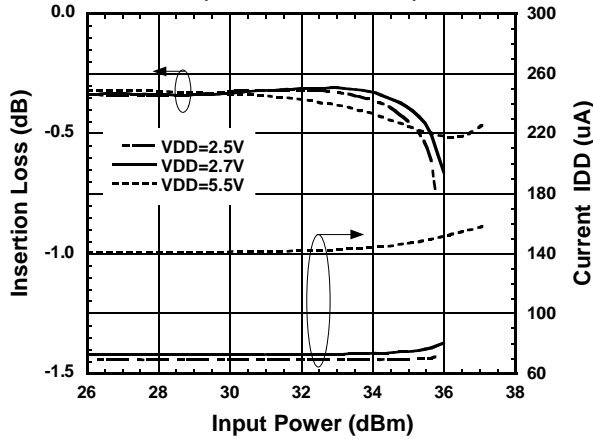

Insertion Loss, Current IDD vs. Input Power

(PC-P2on, f=1GHz)

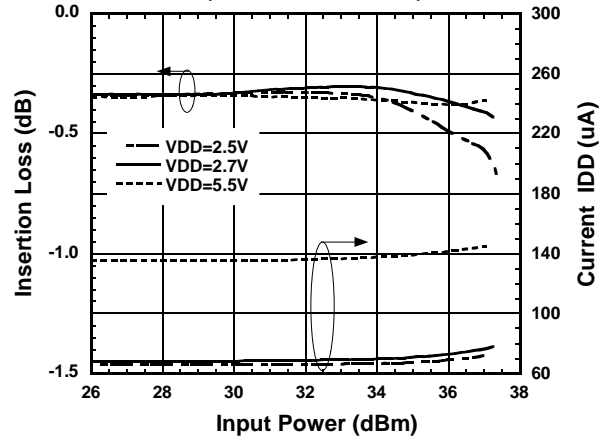

PC-P1 Isolation vs. Input Power

(PC-P2on, f=1GHz)

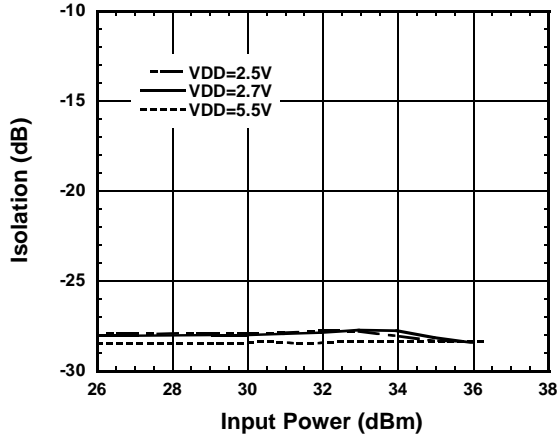

PC-P2 Isolation vs. Input Power

(PC-P1on, f=1GHz)

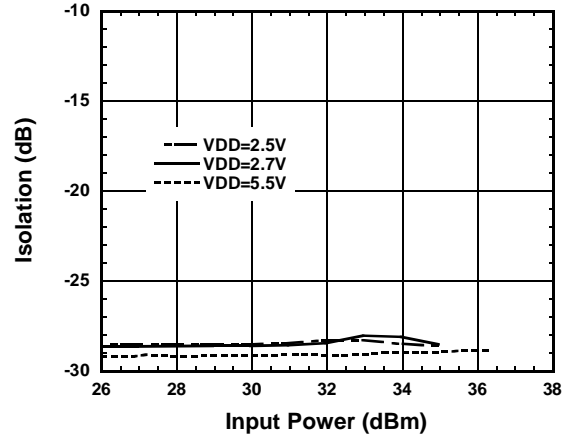

Insertion Loss, Current IDD vs. Input Power

(PC-P1on, f=2GHz)

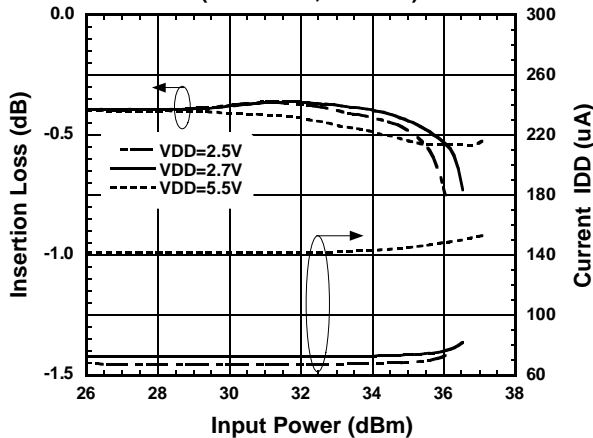

Insertion Loss, Current IDD vs. Input Power

(PC-P2on, f=2GHz)

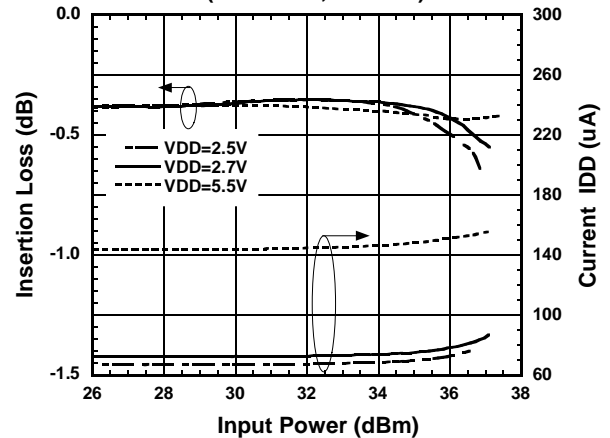

NJG1535HD3

ELECTRICAL CHARACTERISTICS

(Application circuit (Parts list 3))

PC-P1 Isolation vs.Input Power

(PC-P2on, f=2GHz)

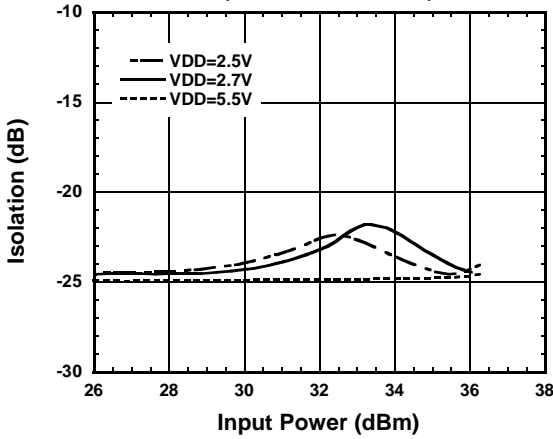

PC-P2 Isolation vs.Input Power

(PC-P1on, f=2GHz)

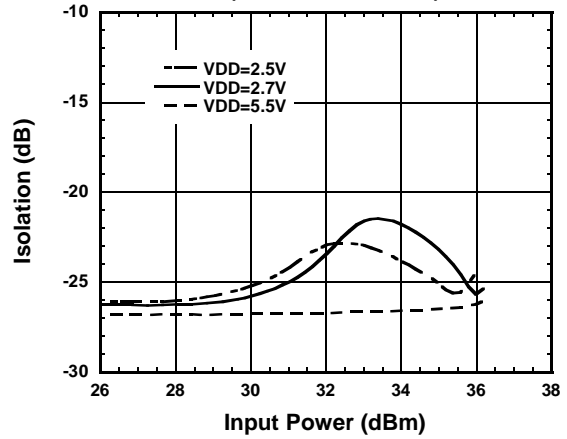

2nd Harmonics vs.Input Power

(f=1GHz, PC-P1on)

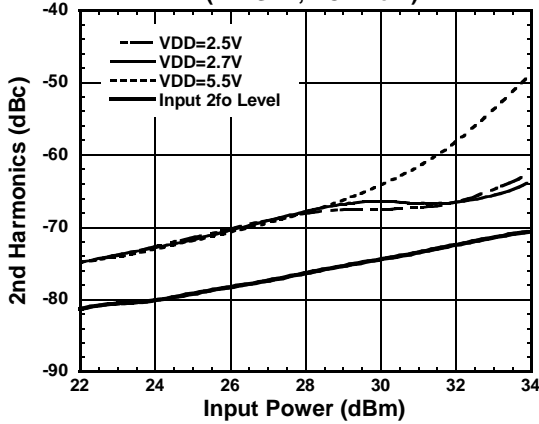

3rd Harmonics vs.Input Power

(f=1GHz, PC-P1on)

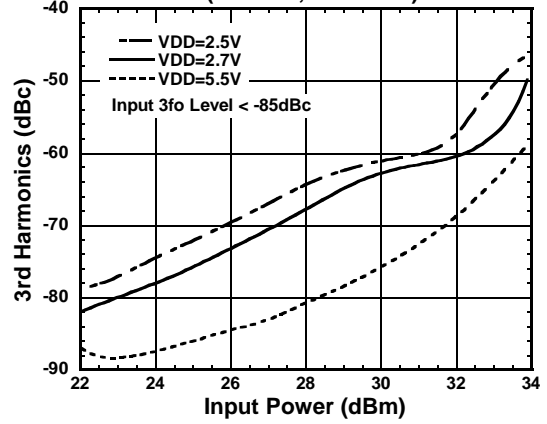

2nd Harmonics vs.Input Power

(f=2GHz, PC-P1on)

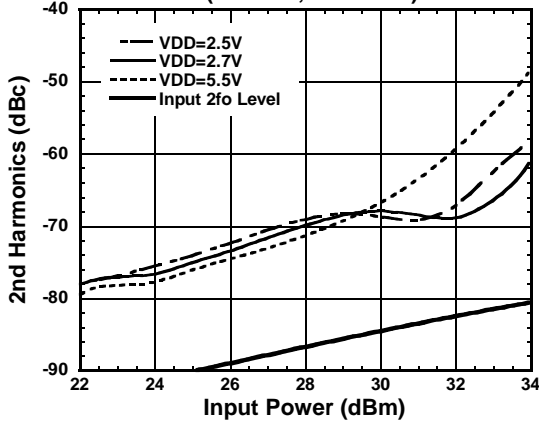

3rd Harmonics vs.Input Power

(f=2GHz, PC-P1on)

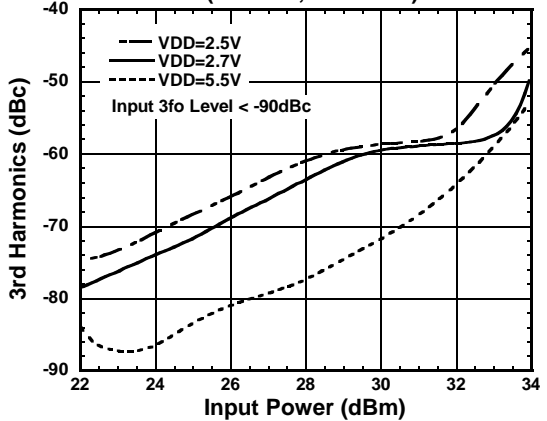

ELECTRICAL CHARACTERISTICS

(Application circuit (Parts list 3))

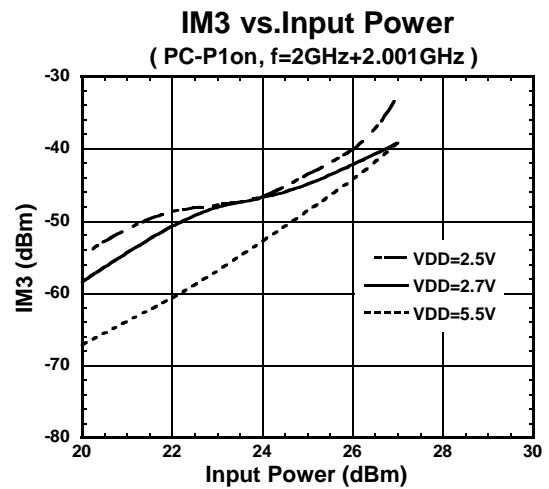
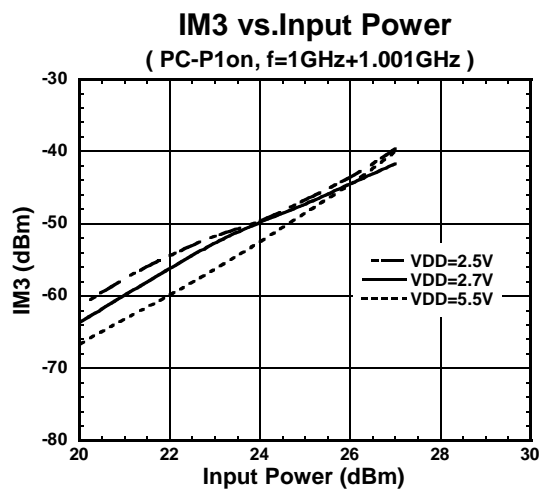
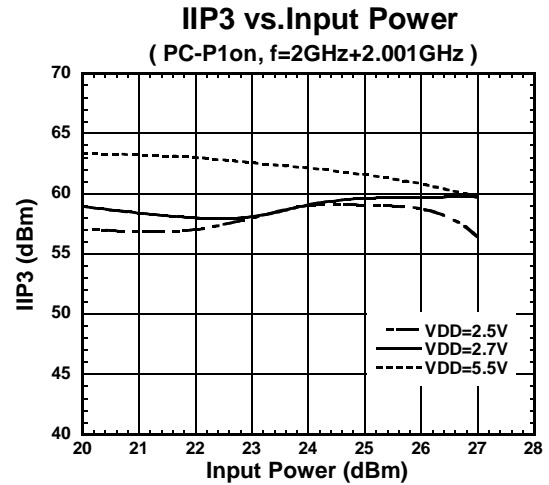
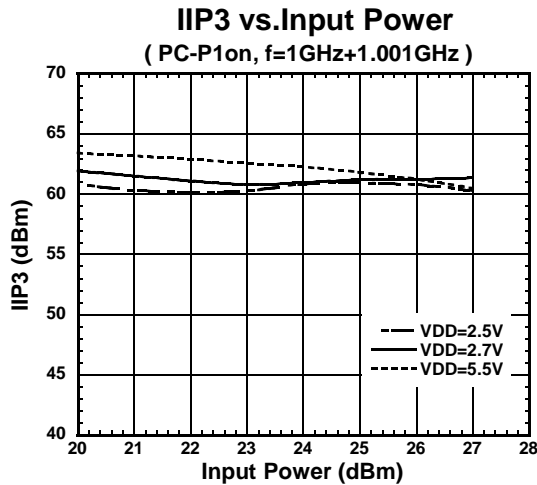
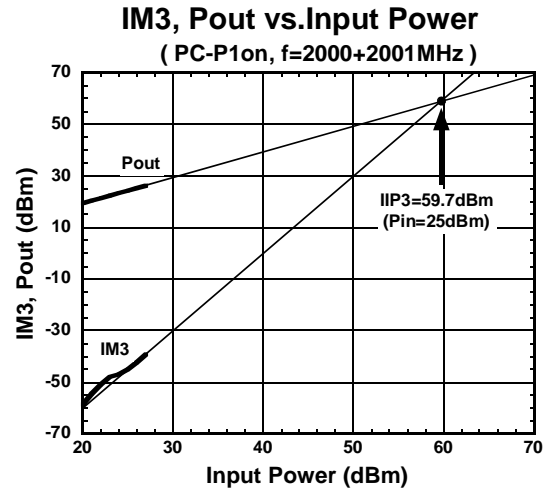
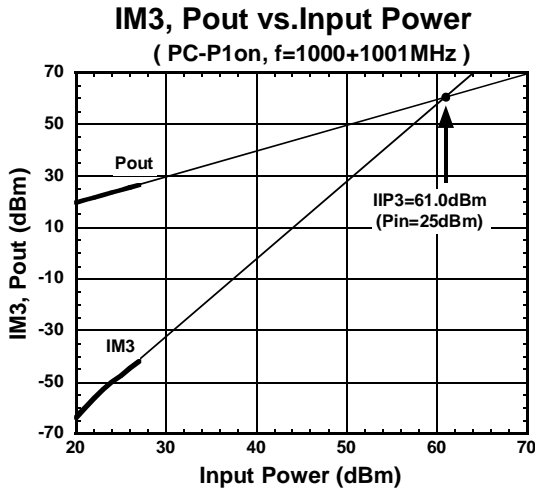

NJG1535HD3

ELECTRICAL CHARACTERISTICS

(Application circuit (Parts list 3))

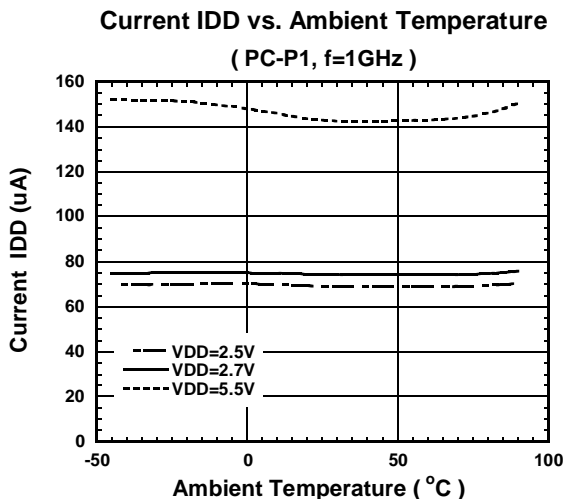
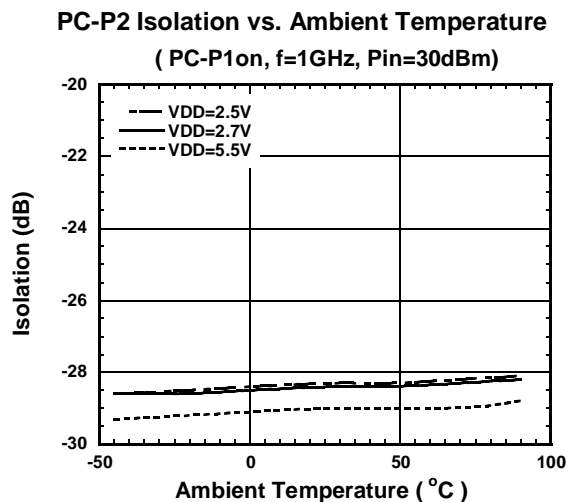
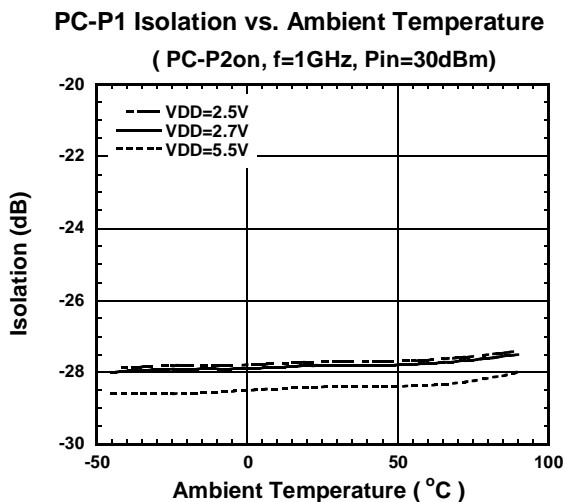
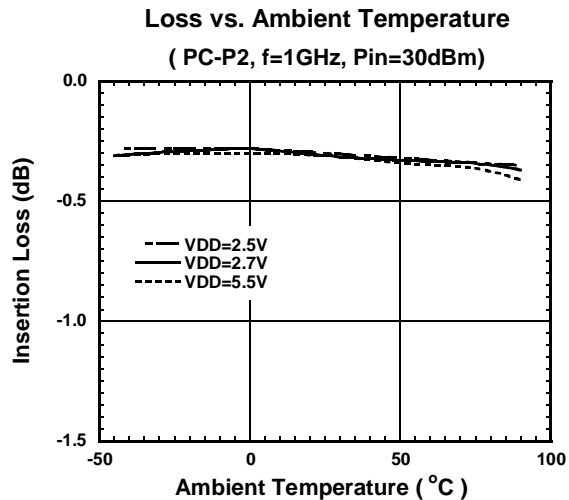
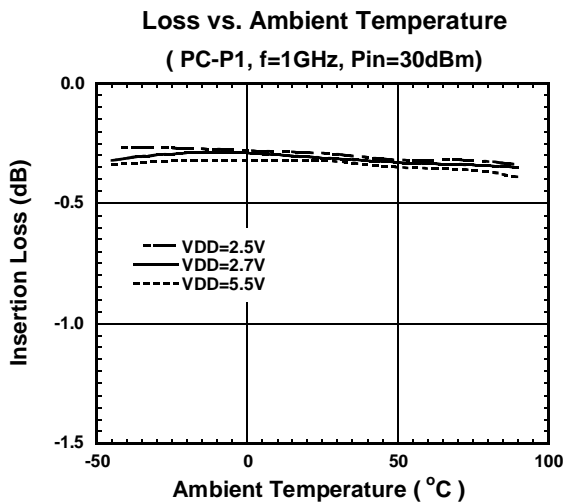

ELECTRICAL CHARACTERISTICS

(Application circuit (Parts list 3))

Loss vs. Ambient Temperature

(PC-P1, f=2GHz, Pin=30dBm)

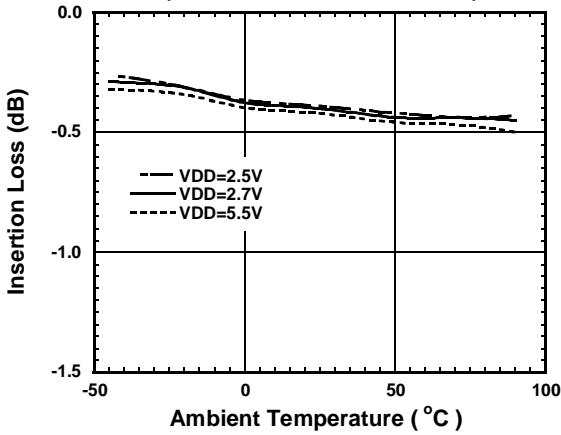

Loss vs. Ambient Temperature

(PC-P2, f=2GHz, Pin=30dBm)

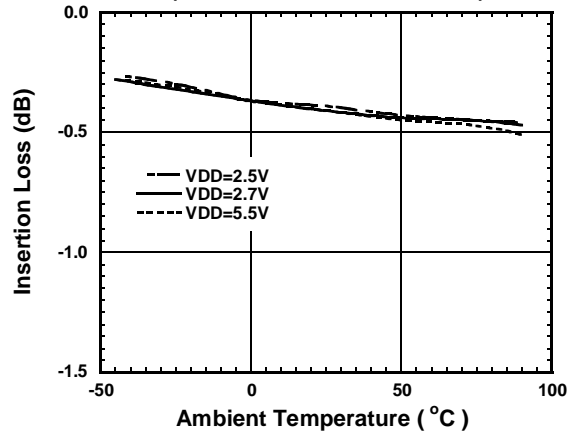

PC-P1 Isolation vs. Ambient Temperature

(PC-P2on, f=2GHz, Pin=30dBm)

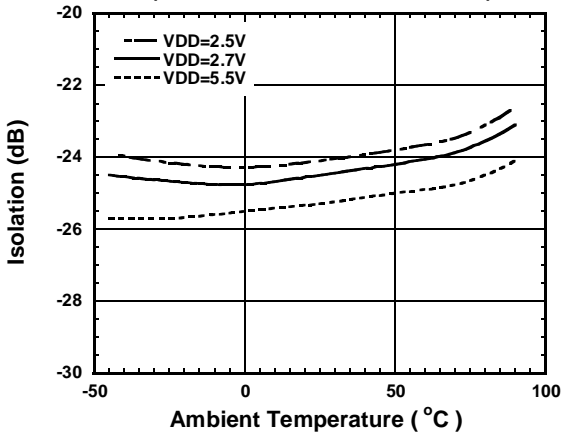

PC-P2 Isolation vs. Ambient Temperature

(PC-P1on, f=2GHz, Pin=30dBm)

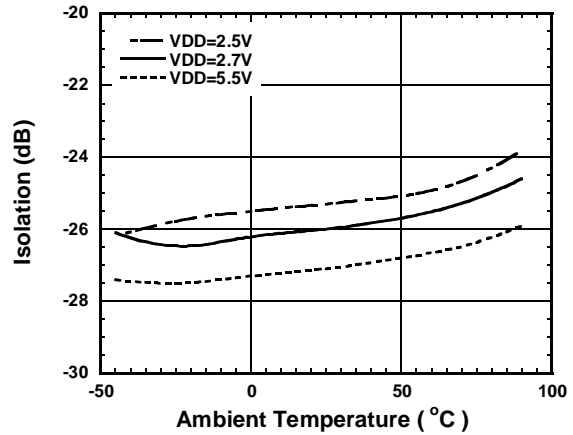

Current IDD vs. Ambient Temperature

(PC-P1, f=2GHz)

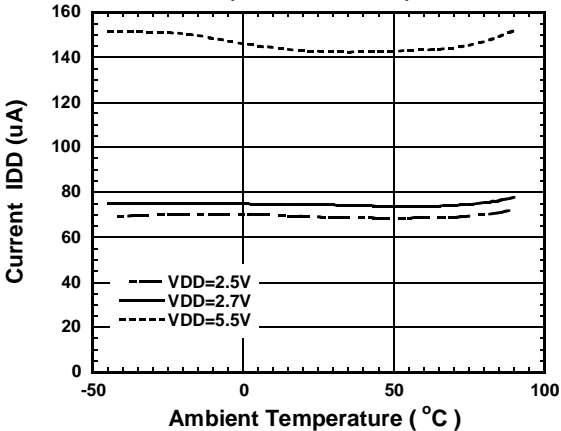

Switching Speed
(Vctl(L)=0V, Vctl(H)=2.7V)

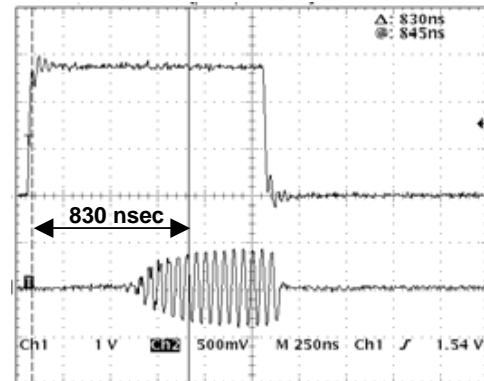

NJG1535HD3

APPLICATION CIRCUIT

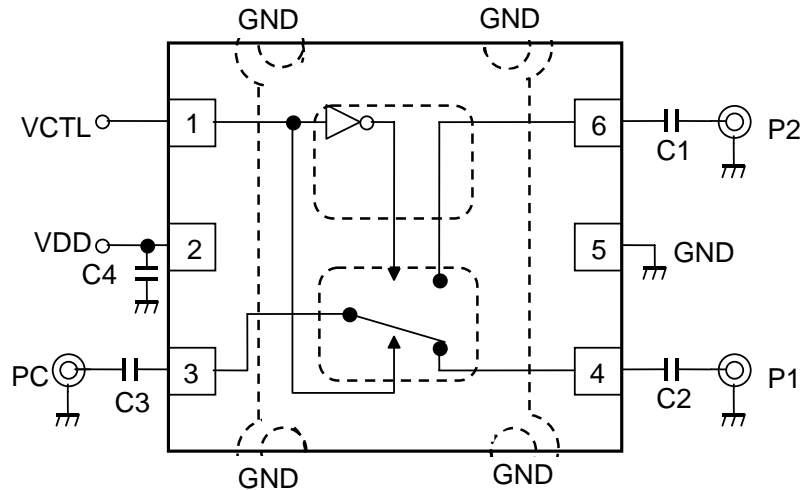

RECOMMENDED PCB DESIGN

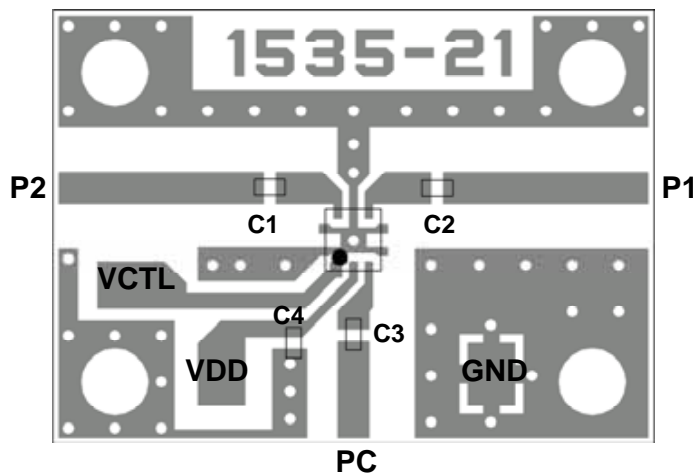

Losses of PCB, connector and DC blocking capacitor are included. (Parts list 3)

freq[GHz]	LOSS[dB]
0.8	0.11
1.0	0.13
1.5	0.16
1.8	0.20
2.0	0.22
2.5	0.26

PCB: FR-4, t=0.5mm
Capacitor: size 1005
Strip line Width=1.0mm

RPARTS LIST

No.	Parts list 1	Parts list 2	Parts list 3
	f=50~100MHz	f=0.1~0.5GHz	f=0.5~2.0GHz
C1, C2, C3	0.01uF	1000pF	56pF
C4	1000pF	1000pF	1000pF

PRECAUTIONS

- [1]The DC blocking capacitors have to be placed at RF terminal of P1, P2 and PC. Please choose appropriate capacitance values to the application frequency.
- [2]To reduce strip line influence on RF characteristics, please locate bypass capacitors(C4) close to each terminals.
- [3]For good isolation, the GND terminal (5th pin) must be placed possibly close to ground plane of substrate, and through holes for GND should be placed near by the pin connection.
- [4]Please connect bottom side GND electrode to RF GND.

PACKAGE OUTLINE (USB6-D3)

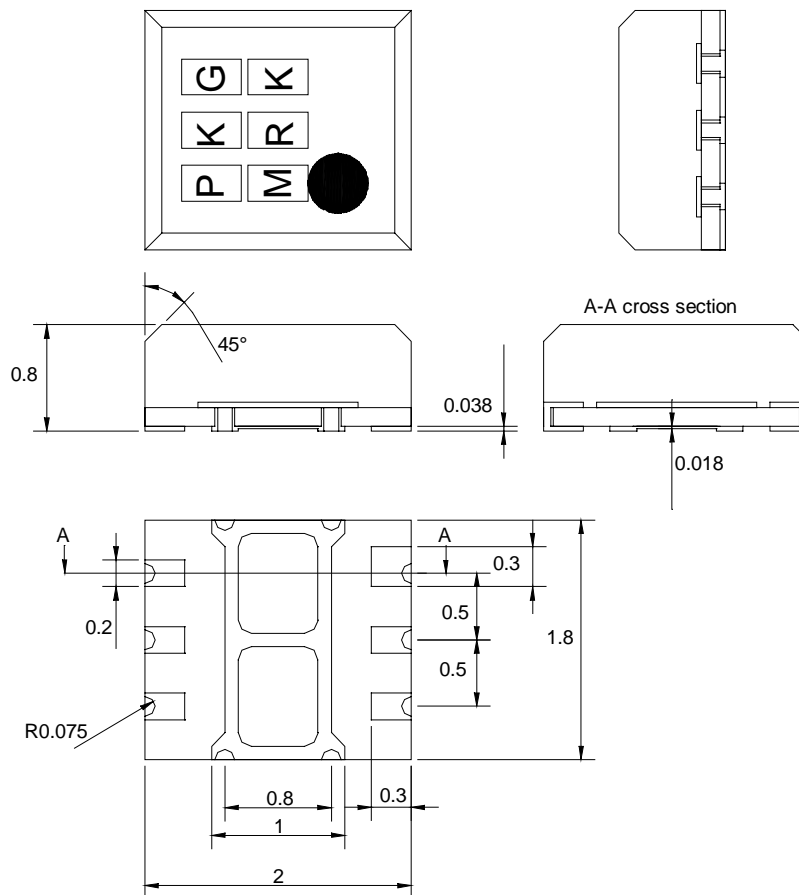

TERMINAL TREAT :Au
 PCB :FR5
 Molding material : Epoxy resin
 UNIT :mm
 WEIGHT :13mg

Cautions on using this product

This product contains Gallium-Arsenide (GaAs) which is a harmful material.

- Do NOT eat or put into mouth.
- Do NOT dispose in fire or break up this product.
- Do NOT chemically make gas or powder with this product.
- To waste this product, please obey the relating law of your country.

[CAUTION]

The specifications on this databook are only given for information, without any guarantee as regards either mistakes or omissions. The application circuits in this databook are described only to show representative usages of the product and not intended for the guarantee or permission of any right including the industrial rights.

This product may be damaged with electric static discharge (ESD) or spike voltage. Please handle with care to avoid these damages.