

SP3T SWITCH GaAs MMIC

■GENERAL DESCRIPTION

NJG1548PC1 is a GaAs high power SP3T switch MMIC for antenna switch of tri-mode cellular phone applications such as CDMA, AMPS and PCS. This switch features low loss, high isolation, low operation current and low distortion at high input power. The SP3T switch MMIC is controlled by internal Si C-MOS decoder IC that has 2bit input signal ports.

The ultra small & ultra thin FFP16-C1 package is applied.

■PACKAGE OUTLINE



NJG1548PC1

■FEATURES

- Low voltage operation
- Pin at 0.2dB compression point
- Low insertion loss

- High isolation

- Low operation current
- Ultra small & ultra thin package

$V_{DD}=2.5V$ min, $V_{CTL(H)}=1.5V$ min
 35dBm typ. @ $f=0.9GHz$, $V_{DD}=2.7V$
 0.40dB typ. @ $f=0.9GHz$, $P_{IN}=25dBm$, $V_{DD}=2.7V$
 0.50dB typ. @ $f=1.9GHz$, $P_{IN}=25dBm$, $V_{DD}=2.7V$
 30dB typ. @ $f=0.9GHz$, $P_{IN}=25dBm$, $V_{DD}=2.7V$
 30dB typ. @ $f=1.9GHz$, $P_{IN}=25dBm$, $V_{DD}=2.7V$
 $5\mu A$ typ. @ $P_{IN}=25dBm$, $V_{DD}=2.7V$
 FFP16-C1 (Package size: 2.5 x 2.5 x 0.85mm)

■PIN CONFIGURATION

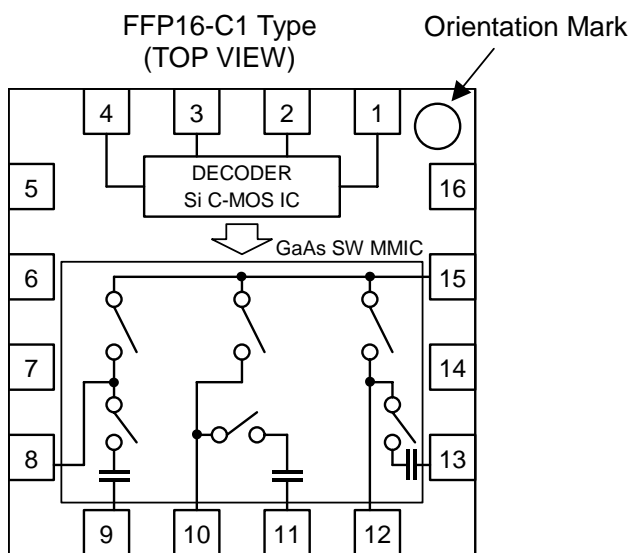

Pin Connection

- | | |
|---------|---------|
| 1. GND | 9. GND |
| 2. CTL2 | 10. RF2 |
| 3. CTL1 | 11. GND |
| 4. VDD | 12. RF1 |
| 5. GND | 13. GND |
| 6. GND | 14. GND |
| 7. GND | 15. ANT |
| 8. RF3 | 16. GND |

■TRUTH TABLE

CTL1	CTL2	Path
H	L	ANT-RF1
L	H	ANT-RF2
H	H	ANT-RF3

"H"= $V_{CTL(H)}$, "L"= $V_{CTL(L)}$

NOTE: Please note that any information on this catalog is subject to change.

NJG1548PC1

■ABSOLUTE MAXIMUM RATINGS

(T_a=+25°C, Z_s=Z_i=50Ω)

PARAMETER	SYMBOL	CONDITIONS	RATINGS	UNITS
RF Input Power	P _{IN}	V _{DD} =2.7V	36	dBm
Supply Voltage	V _{DD}	VDD Terminal	6.0	V
Control Voltage	V _{CTL}	CTL1 and CTL2 Terminals	6.0	V
Power Dissipation	P _D	At on PCB board	400	mW
Operating Temperature	T _{opr}		-40~+85	°C
Storage Temperature	T _{stg}		-55~+150	°C

■ELECTRICAL CHARACTERISTICS

(General conditions: T_a=+25°C, Z_s=Z_i=50Ω, V_{CTL(L)}=0V, V_{CTL(H)}=2.7V)

PARAMETER	SYMBOL	CONDITIONS	MIN	TYP	MAX	UNITS
Operation Voltage	V _{DD}		2.5	2.7	5.0	V
Operating Current	I _{DD}	P _{IN} =25dBm	-	5.0	30	μA
Control Voltage (Low)	V _{CTL(L)}		0	-	0.4	V
Control Voltage (High)	V _{CTL(H)}		1.5	2.7	V _{DD}	V
Control Current	I _{CTL}		-1.0	-	1.0	μA
Insertion Loss 1	LOSS1	f=0.9GHz, P _{IN} =25dBm	-	0.40	0.55	dB
Insertion Loss 2	LOSS2	f=1.9GHz, P _{IN} =25dBm	-	0.50	0.65	dB
Isolation 1	ISL1	f=0.9GHz, P _{IN} =25dBm	25	30	-	dB
Isolation 2	ISL2	f=1.9GHz, P _{IN} =25dBm	25	30	-	dB
Pin at 0.2dB Compression Point1	P _{-0.2dB(1)}	f=0.9GHz	32.5	35	-	dBm
Pin at 0.2dB Compression Point2	P _{-0.2dB(2)}	f=1.9GHz	32.5	35	-	dBm
2nd Harmonics 1	2fo(1)	f=0.9GHz, P _{IN} =25dBm	-	-71	-60	dBc
2nd Harmonics 2	2fo(2)	f=1.9GHz, P _{IN} =25dBm	-	-75	-60	dBc
3rd Harmonics 1	3fo(1)	f=0.9GHz, P _{IN} =25dBm	-	-75	-60	dBc
3rd Harmonics 2	3fo(2)	f=1.9GHz, P _{IN} =25dBm	-	-75	-60	dBc
Input 3 rd order Intercept Point 1	IIP3(1)	f=0.9+0.901GHz, P _{in} =25dBm *1	+55	+60	-	dBm
Input 3 rd order Intercept Point 2	IIP3(2)	f=1.9+1.901GHz, P _{in} =25dBm *1	+55	+60	-	dBm
VSWR	VSWR _i	on-state ports, f=1.9GHz	-	1.2	1.4	
Switching Time	T _{SW}		-	0.35	-	μs

*1: The input IP3 is defined as following equation.

$$IIP3 = (3 \times P_{out} - IM3) / 2 + LOSS$$

■ TERMINAL INFORMATION

No.	SYMBOL	DESCRIPTION
1, 4, 5, 6 7, 9, 11, 13, 14, 16	GND	Ground terminal. Please connect this terminal with ground plane as close as possible for excellent RF performance.
15	ANT	RF port for Tx/Rx signal. An external capacitor is required to block the DC bias voltage (V_{DD}).
2	CTL2	Control signal input terminal of high impedance C-MOS. High level: +1.5V~VDD, Low level: 0~0.4V. Please connect this terminal to GND or VDD portion by 100k Ω resistor if the voltage level of this terminal is undefined.
3	CTL1	Control signal input terminal of high impedance C-MOS. High level: +1.5V~VDD, Low level: 0~0.4V. Please connect this terminal to GND or VDD portion by 100k Ω resistor if the voltage level of this terminal is undefined.
4	VDD	Positive power supply terminal. The positive voltage (+2.5~+5.0V) has to be supplied with or before other DC voltage supply terminal to avoid latch up effect.
8	RF3	RF port. To block the DC bias voltage of internal circuit, an external capacitor is required.
10	RF2	RF port. To block the DC bias voltage of internal circuit, an external capacitor is required.
12	RF1	RF port. To block the DC bias voltage of internal circuit, an external capacitor is required.

■ ELECTRICAL CHARACTERISTICS (with application circuit, Losses of external circuit are excluded)

Loss, ISL vs. Frequency

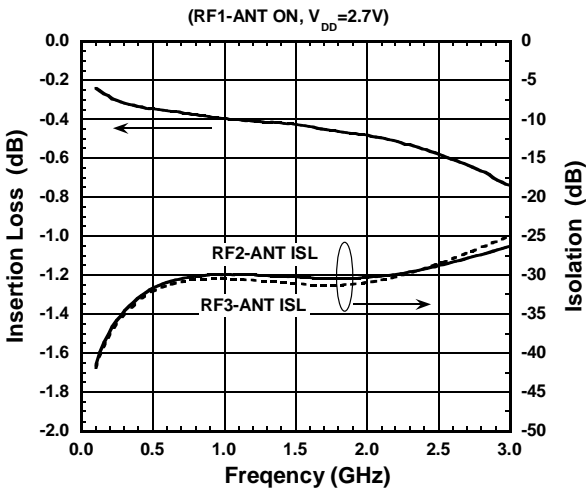

Loss, ISL vs. Frequency

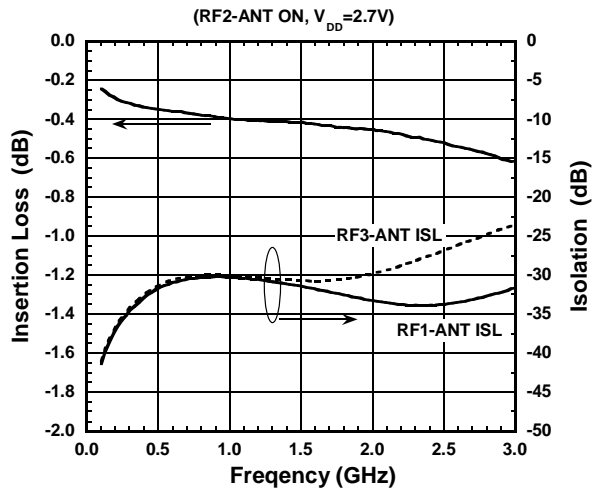

Loss, ISL vs. Frequency

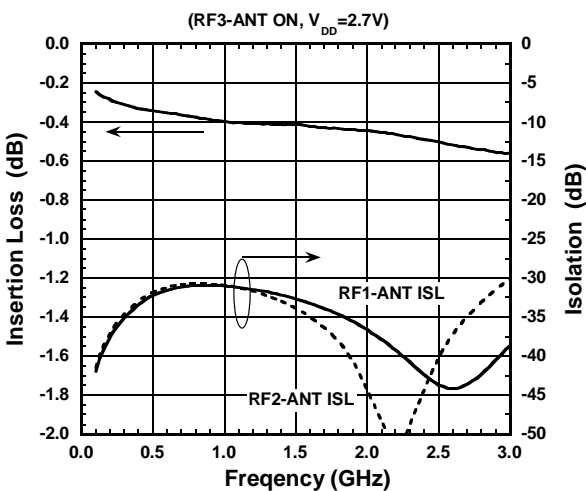

VSWR vs Frequency

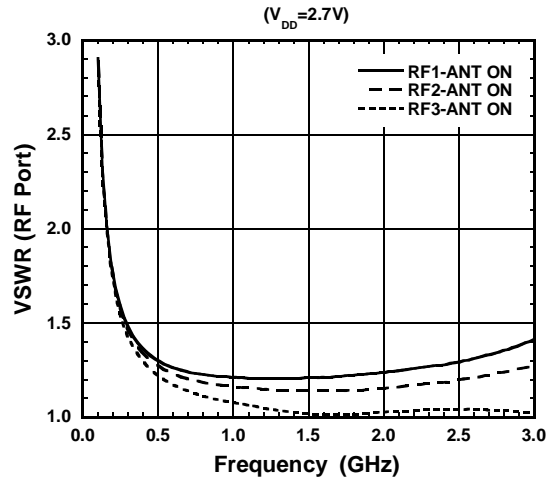

Switching Time

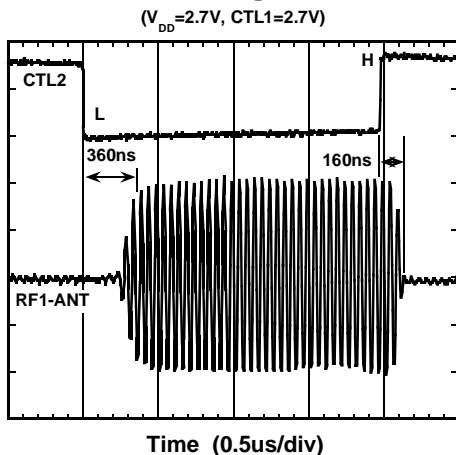

■ ELECTRICAL CHARACTERISTICS (with application circuit, Losses of external circuit are excluded)

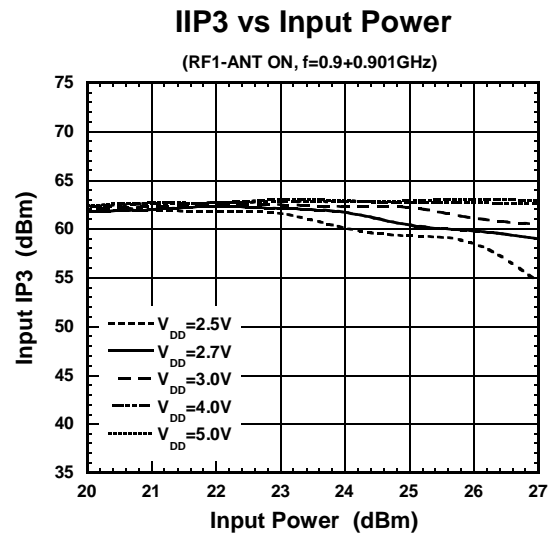
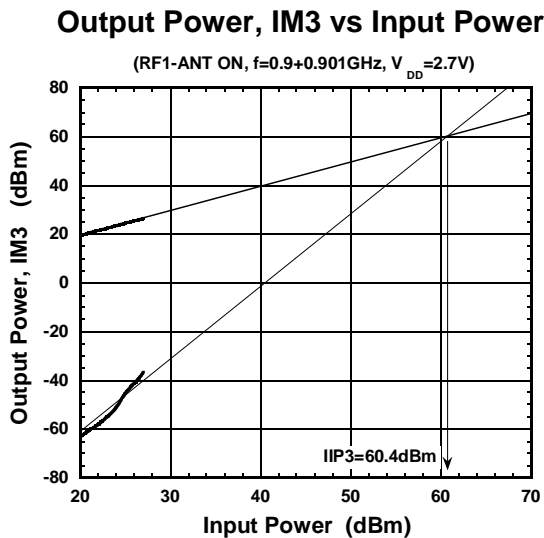
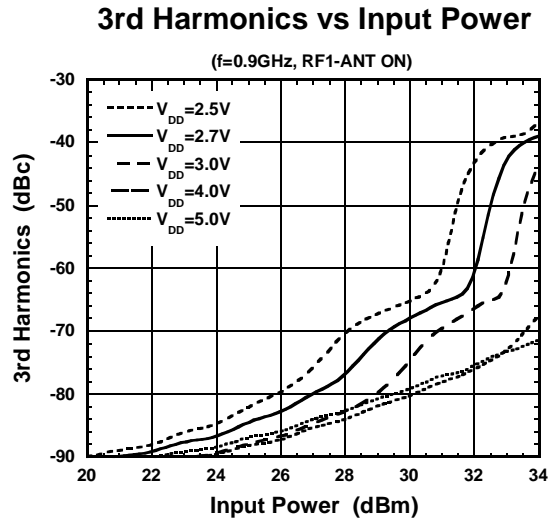
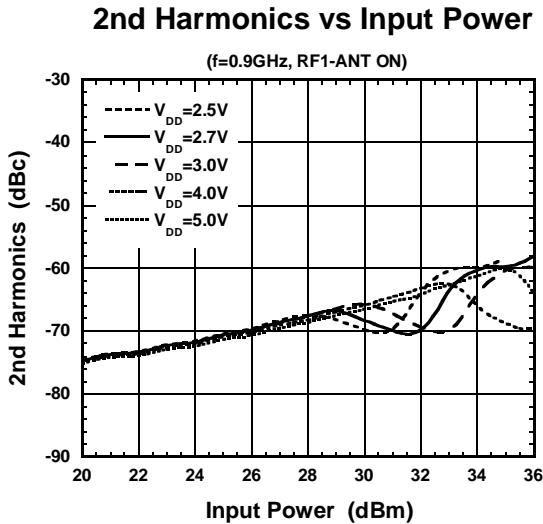
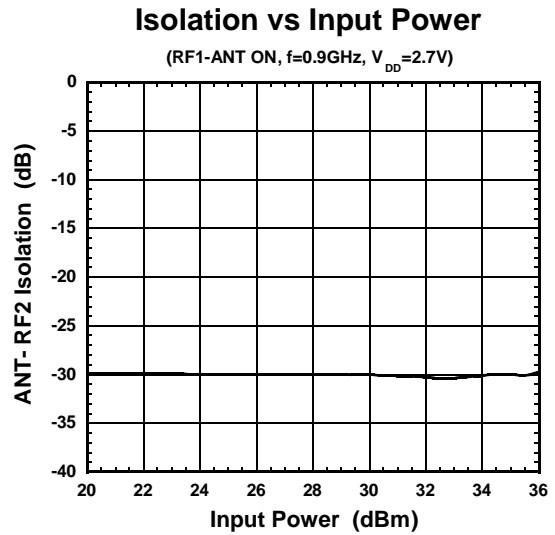
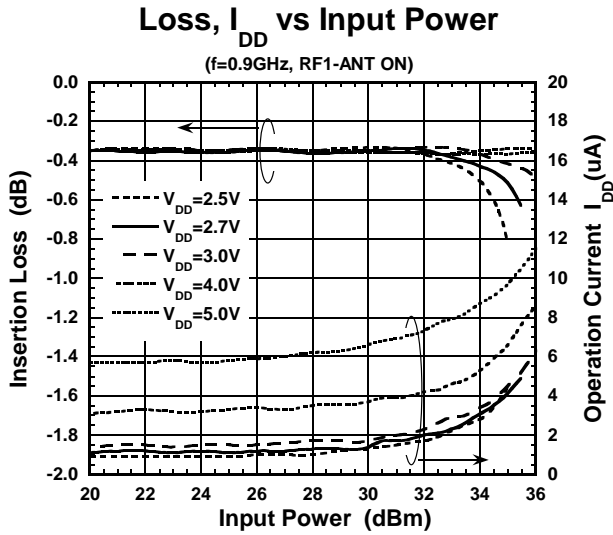

NJG1548PC1

ELECTRICAL CHARACTERISTICS (with application circuit, Losses of external circuit are excluded)

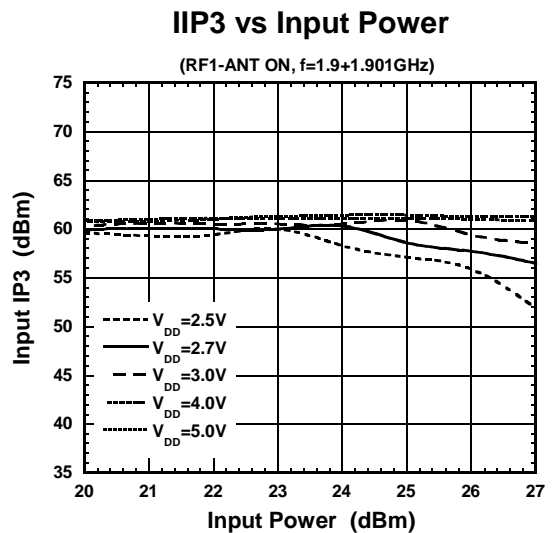
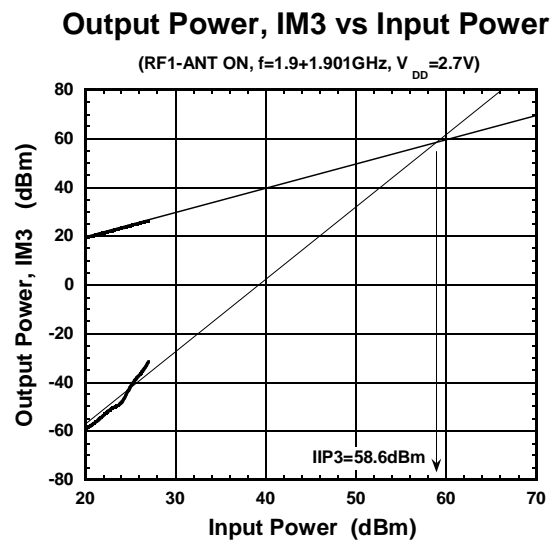
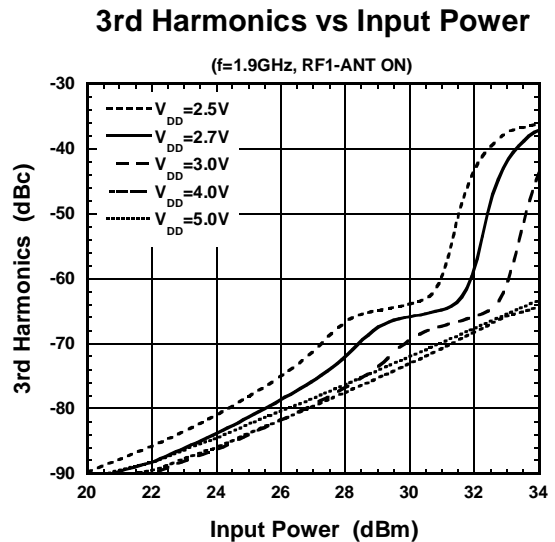
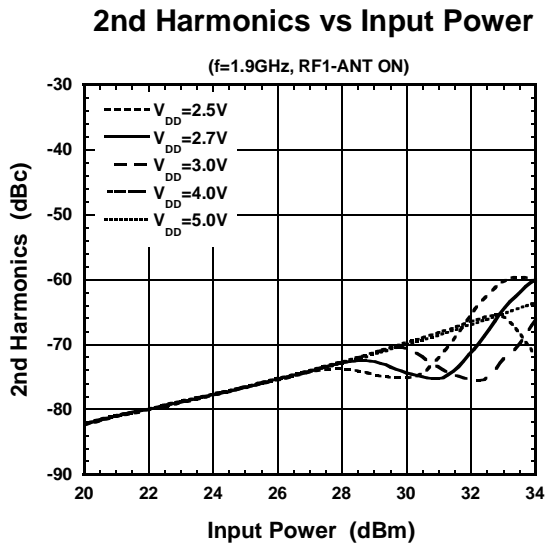
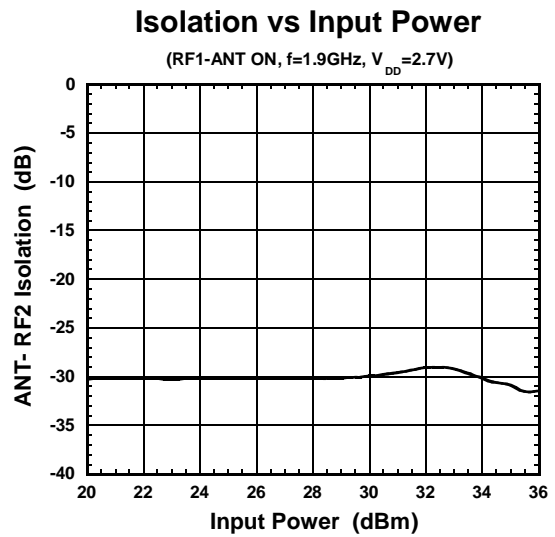
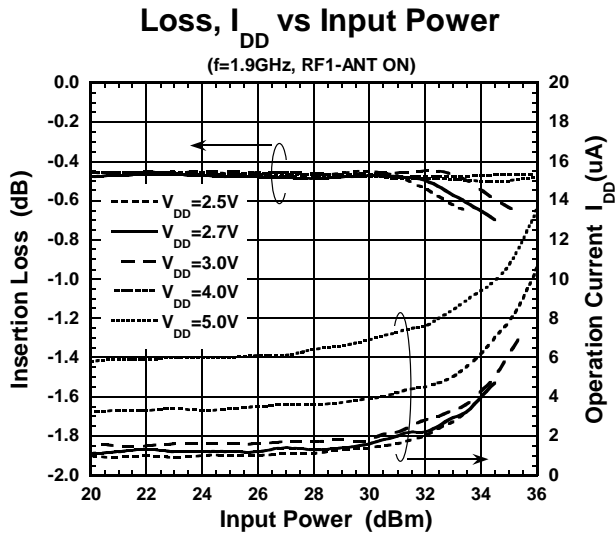

■ ELECTRICAL CHARACTERISTICS (with application circuit, Losses of external circuit are excluded)

Loss, ISL vs Ambient Temperature

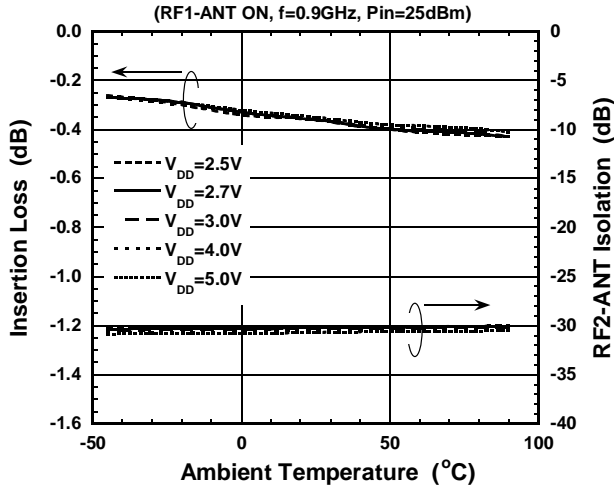

I_{DD} vs Ambient Temperature

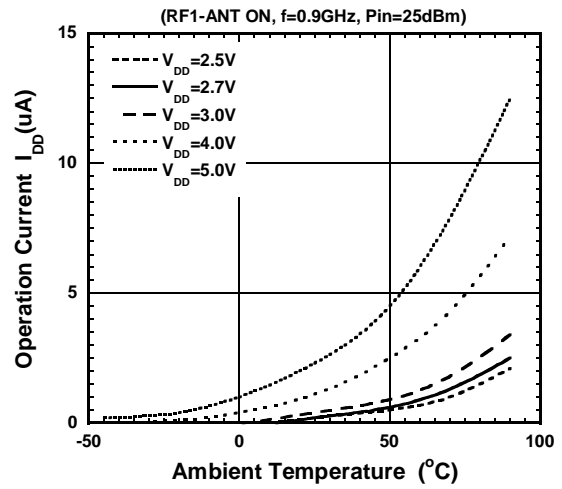

P_{-0.2dB} vs Ambient Temperature

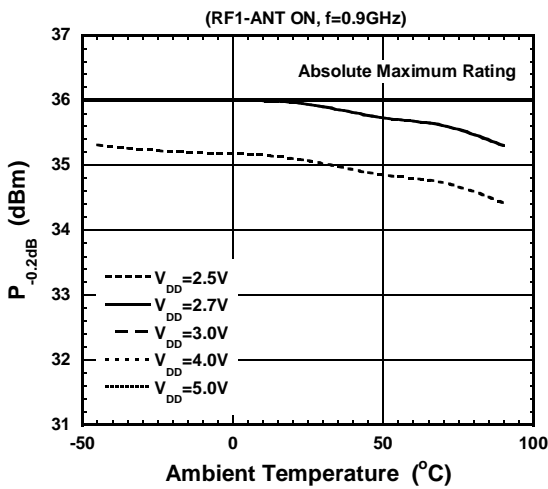

IIP3 vs Ambient Temperature

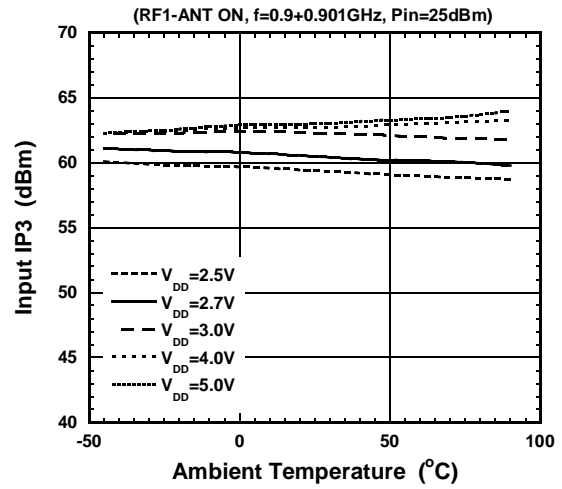

2f₀ vs Ambient Temperature

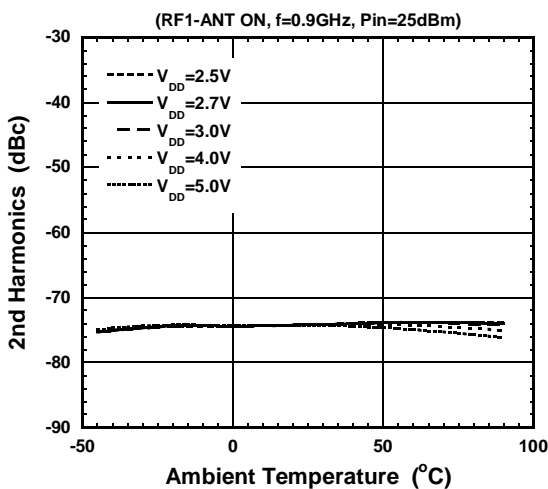

3f₀ vs Ambient Temperature

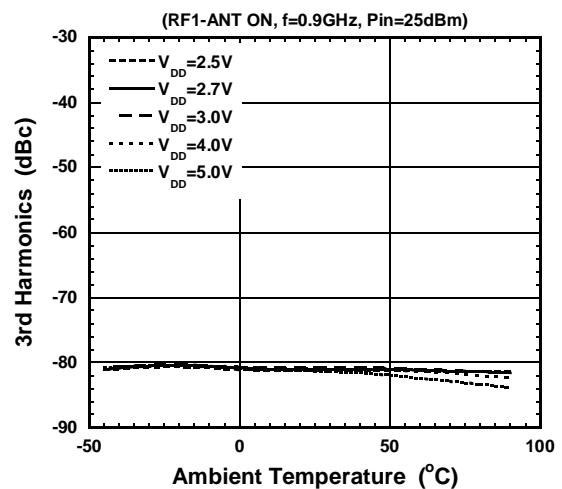

NJG1548PC1

ELECTRICAL CHARACTERISTICS (with application circuit, Losses of external circuit are excluded)

Loss, ISL vs Ambient Temperature

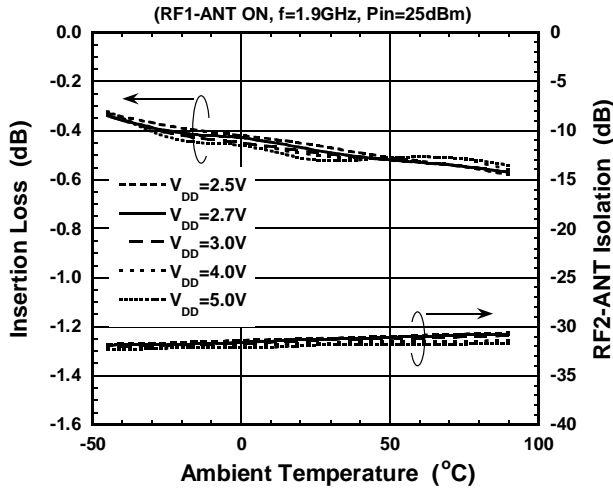

$P_{-0.2\text{dB}}$ vs Ambient Temperature

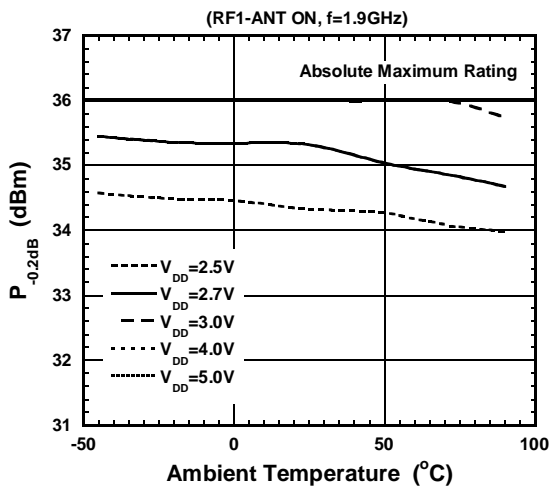

IIP3 vs Ambient Temperature

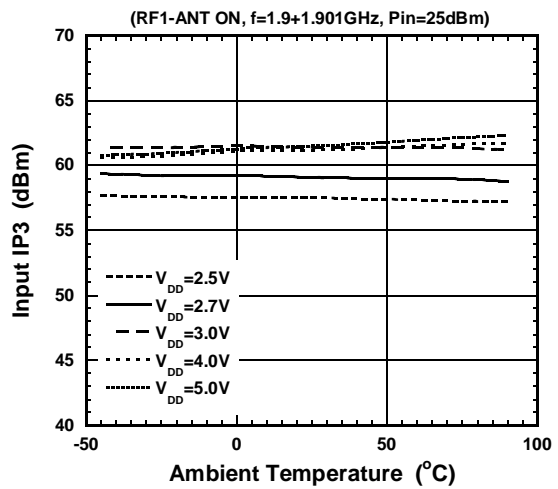

$2f_0$ vs Ambient Temperature

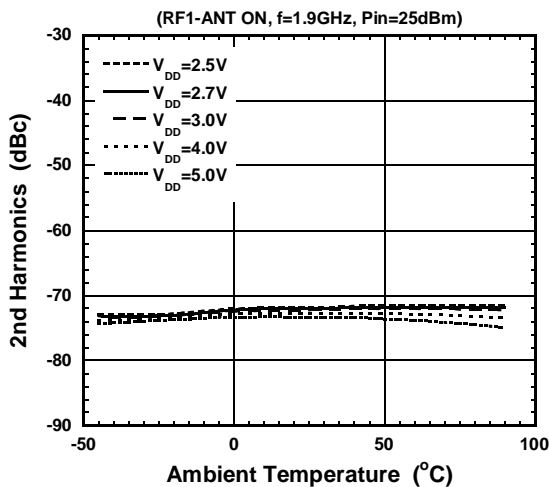

$3f_0$ vs Ambient Temperature

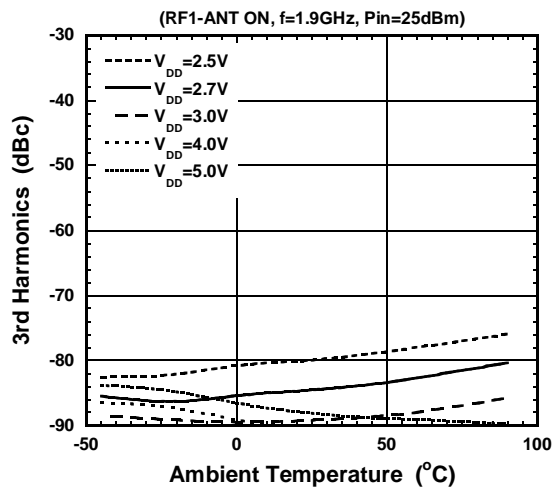

APPLICATION CIRCUIT

(TOP VIEW)

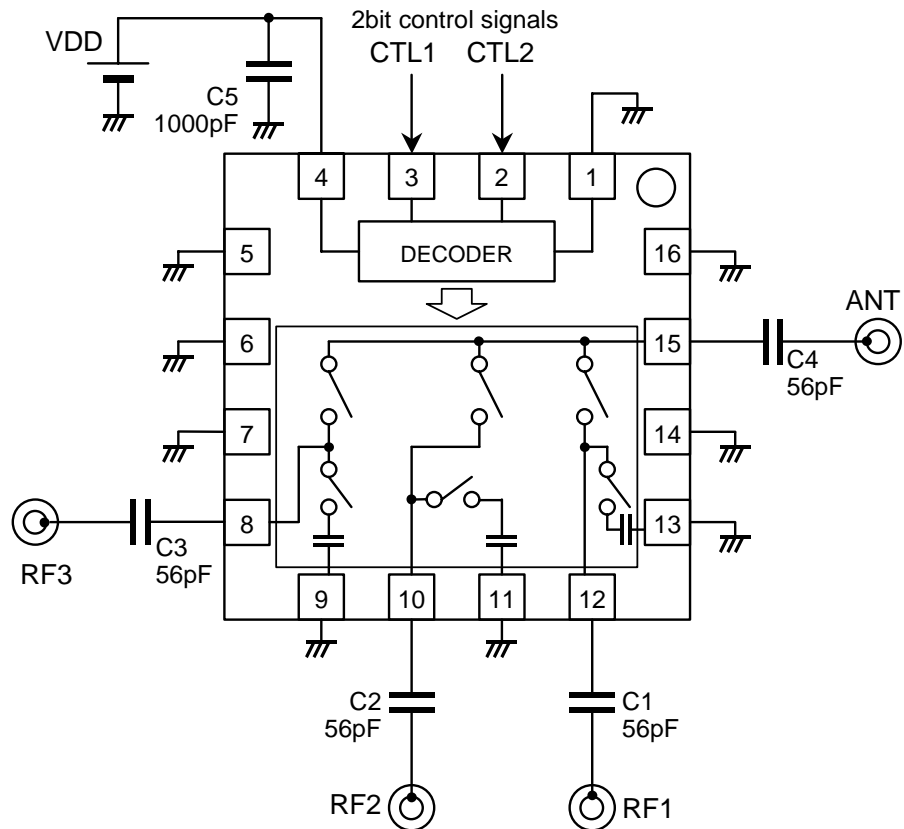

NJG1548PC1

RECOMMENDED PCB DESIGN

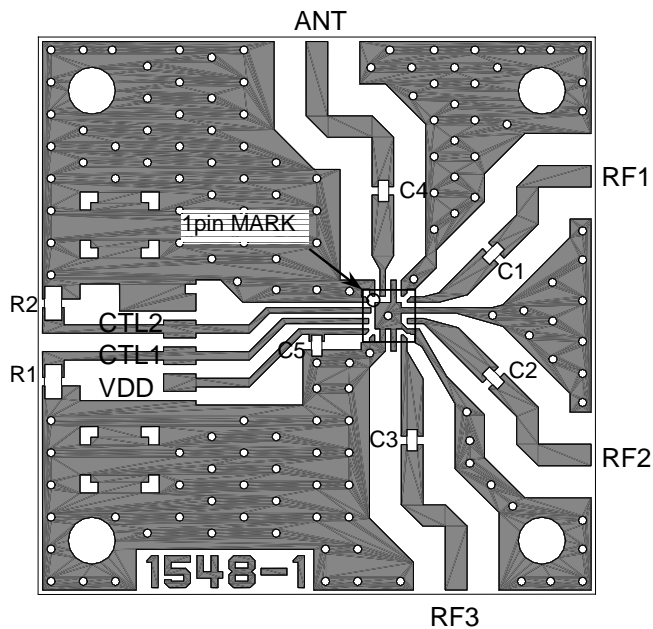

PCB SIZE = 26 x 26 mm

PCB: FR4, t=0.5mm

CAPACITOR: size 1005

STRIP LINE WIDTH = 1mm($Z_0=50\Omega$)

PARTS LIST

Parts	Value	Notes
C1~C4	56pF	MURATA (GRM15)
C5	1000pF	
R1, R2 ^(*)	100k Ω	

(*1) If the voltage level of CTL1/CTL2 is unstable, please connect R1, R2 with GND or VDD respectively.

BOARD TOTAL LOSS

(DC blocking capacitor, Connector and PCB)

Pass	0.9GHz	1.9GHz
RF1-ANT	0.18dB	0.27dB
RF2-ANT		
RF3-ANT		

PRECAUTIONS

- [1] DC blocking capacitors have to be placed at ANT, RF1, RF2 and RF3 terminals.
- [2] To reduce strip line influence on RF characteristics, please locate bypass capacitor (C5) close to VDD terminal.
- [3] To avoid degradation of isolation or high power characteristics, please GND terminals (1, 5, 6, 7, 9, 11, 13, 14, 15) must be placed close to grand plane of substrate and through holes for GND should be placed near by the pin connection.

PACKAGE OUTLINE (FFP16-C1)

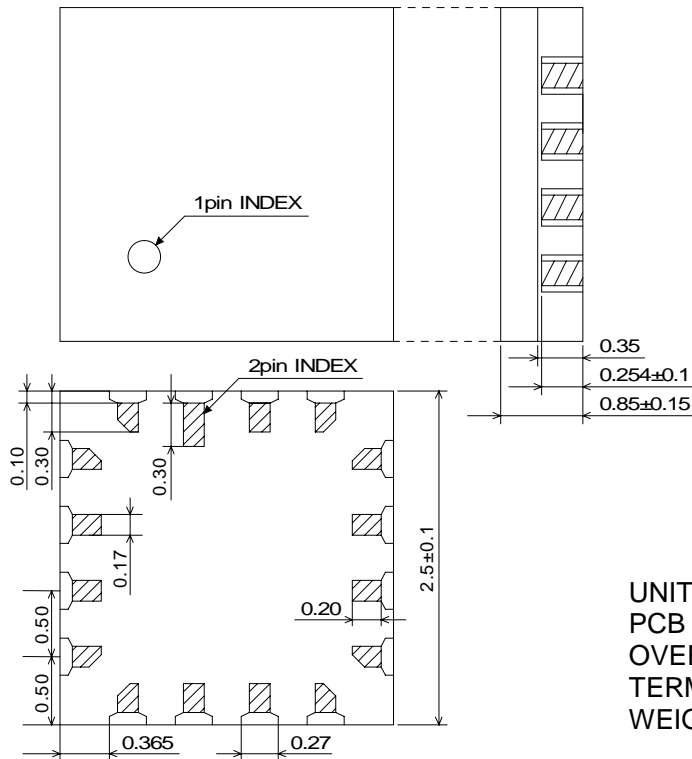

UNIT	: mm
PCB	: Ceramic
OVER COAT	: Epoxy resin
TERMINAL TREAT	: Au
WEIGHT	: 15mg

Cautions on using this product

This product contains Gallium-Arsenide (GaAs) which is a harmful material.

- Do NOT eat or put into mouth.
- Do NOT dispose in fire or break up this product.
- Do NOT chemically make gas or powder with this product.
- To waste this product, please obey the relating law of your country.

[CAUTION]

The specifications on this databook are only given for information, without any guarantee as regards either mistakes or omissions. The application circuits in this databook are described only to show representative usages of the product and not intended for the guarantee or permission of any right including the industrial rights.

This product may be damaged with electric static discharge (ESD) or spike voltage. Please handle with care to avoid these damages.