



GaAs SPDT SWITCH IC

■ GENERAL DESCRIPTION

NJG1506R is a GaAs SPDT switch IC featuring a low loss, a high isolation and a low control current.

In the wide frequency range from 100MHz to 3GHz, this IC operates at a low voltage from 2.5V.

A very small package is adopted.

It is suited for the switch in receiving circuit of RF frequency of cellular radio system.

■ PACKAGE OUTLINE



NJG1506R

■ FEATURES

- Single and low control voltage
- Low insertion loss
- High isolation
- Passing power
- Low control current
- Small package

+2.5~+5.5V

0.3dB Typ. @f=1GHz, P_{in}=0dBm

28dB Typ. @f=1GHz, P_{in}=0dBm

19dBm MAX. @f=2GHz, V_{CTR}=3.0V

1uA Typ. @f=0.1~2.5GHz, P_{in}=10dBm

VSP8

■ PIN CONFIGURATION

R TYPE
(Top View)

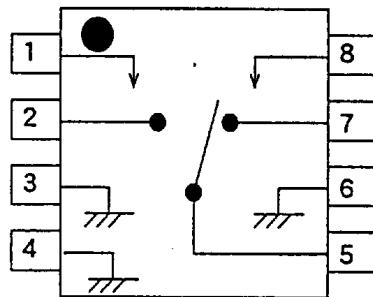

Pin Connection

1. VCTR2
2. P2
3. GND
4. GND
5. PC
6. GND
7. P1
8. VCTR1

■ TRUTH TABLE

"H"=V_{CTR(H)}, "L"=V_{CTR(L)}

V _{CTR1}	H	L	L	H
V _{CTR2}	L	H	L	H
P1-PC	OFF	ON	LOSS=15dB P ₁ Return Loss=-3dB	LOSS=16dB P ₁ Return Loss=-2dB
P2-PC	ON	OFF	LOSS=15dB P ₂ Return Loss=-3dB	LOSS=16dB P ₂ Return Loss=-2dB

NOTE) The values of "LOSS" and "Return Loss" are typical values.

■ ABSOLUTE MAXIMUM RATING

 (T_a=25°C)

PARAMETER	SYMBOL	RATINGS	UNIT
Input power	P _{in}	28	dBm
Control voltage	V _{CTR}	6	V
Power dissipation	P _D	320	mW
Operating Temp.	T _{opr}	-30 ~ +85	°C
Storage Temp.	T _{stg}	-40 ~ +150	°C

■ ELECTRICAL CHARACTERISTICS

 (V_{CTR(L)}=0V, V_{CTR(H)}=2.7V, Z_S=Z_O=50ohm, T_a=25°C)

PARAMETER	SYMBOL	CONDITION	MIN	TYP	MAX	UNIT
Control voltage(L)	V _{CTR(L)}	f=0.1~2.5GHz, P _{in} =10dBm	-0.2	0	0.2	V
Control voltage(H)	V _{CTR(H)}	f=0.1~2.5GHz, P _{in} =10dBm	2.5	2.7	5.5	V
Control current	I _{CTR}	f=0.1~2.5GHz, P _{in} =10dBm	—	1.0	2.0	uA
Insertion loss1	LOSS1	f=1GHz, P _{in} =0dBm	—	0.3	0.6	dB
Insertion loss2	LOSS2	f=2GHz, P _{in} =0dBm	—	0.5	0.8	dB
Isolation1 (PC-P1, PC-P2, P1-P2)	ISL1	f=1GHz, P _{in} =0dBm	25	28	—	dB
Isolation2 (PC-P1, PC-P2, P1-P2)	ISL2	f=2GHz, P _{in} =0dBm	23	27	—	dB
Input power at 1dB compression	P _{-1dB}	f=2GHz	19	22	—	dBm
VSWR (PC, P1, P2)	VSWR	f=0.1~2.5GHz, ON STATE	—	1.2	1.5	
Switching Speed	T _{sw}	f=0.1~2.5GHz	—	15	—	ns



CHARACTERISTICS

(PC-P1) Insertion loss vs. Frequency
 ($V_{CTR}=0V/2.7V$, $P_{Ia}=0dBm$)

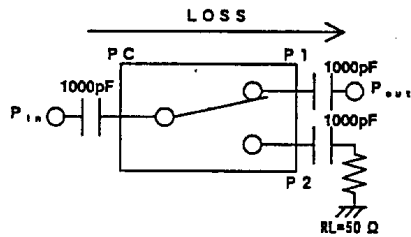
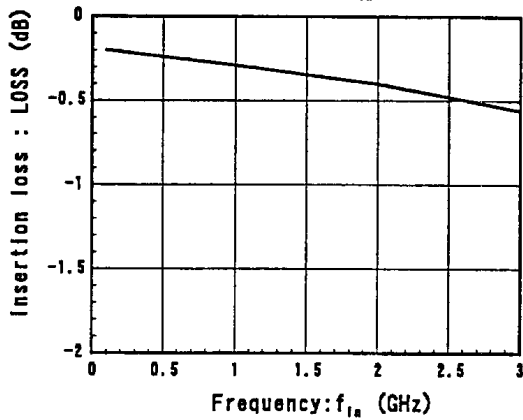

(PC-P2) Insertion loss vs. Frequency
 ($V_{CTR}=0V/2.7V$, $P_{Ia}=0dBm$)

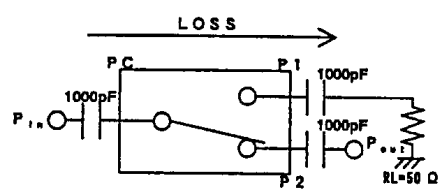
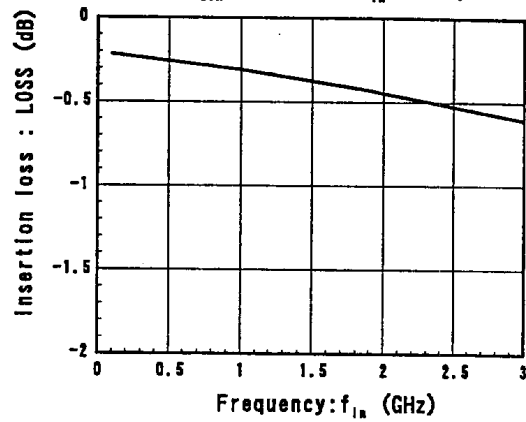

(PC-P1) Isolation vs. Frequency
 ($V_{CTR}=0V/2.7V$, $P_{Ia}=0dBm$)

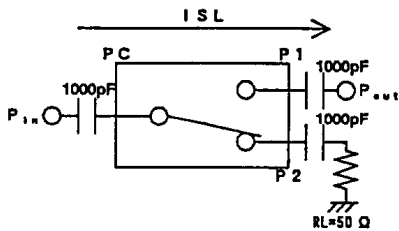
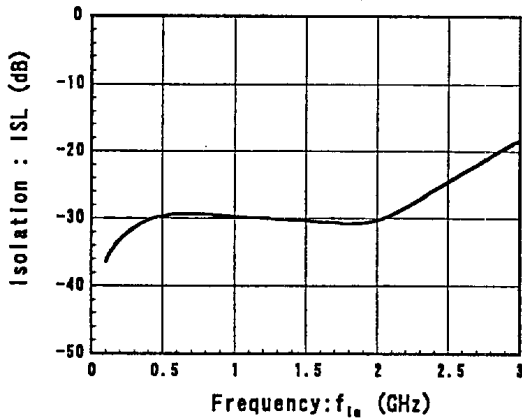

(PC-P2) Isolation vs. Frequency
 ($V_{CTR}=0V/2.7V$, $P_{Ia}=0dBm$)

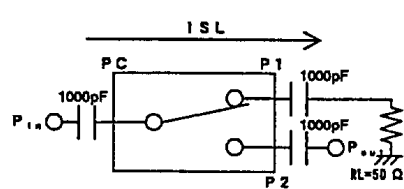
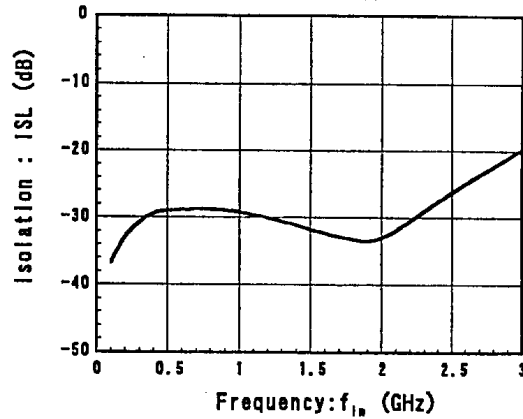



CHARACTERISTICS

P1-PC(ON) V.S.W.R vs. Frequency
 ($V_{CTR}=0V/2.7V$, $P_{in}=0dBm$)

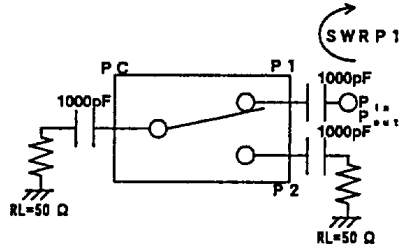
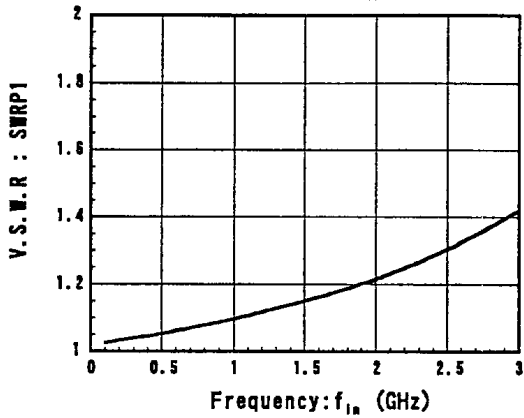

P2-PC(ON) V.S.W.R vs. Frequency
 ($V_{CTR}=0V/2.7V$, $P_{in}=0dBm$)

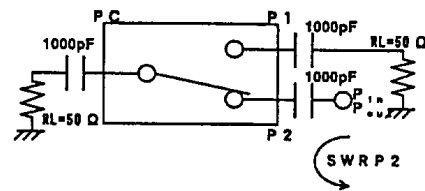
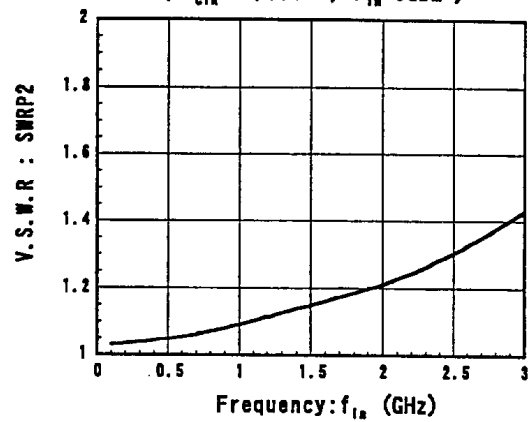

PC-P1(ON) V.S.W.R vs. Frequency
 ($V_{CTR}=0V/2.7V$, $P_{in}=0dBm$)

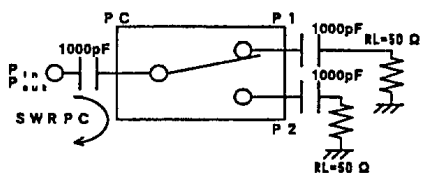
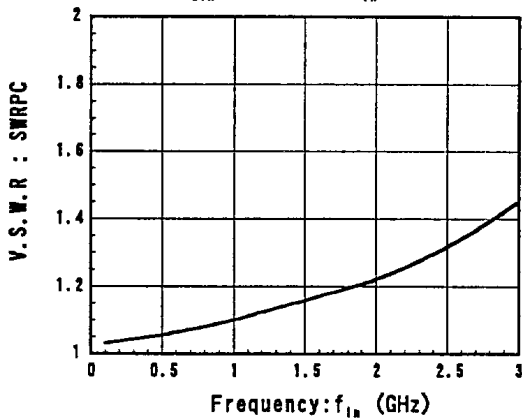

New Japan Radio Co., Ltd.



CHARACTERISTICS

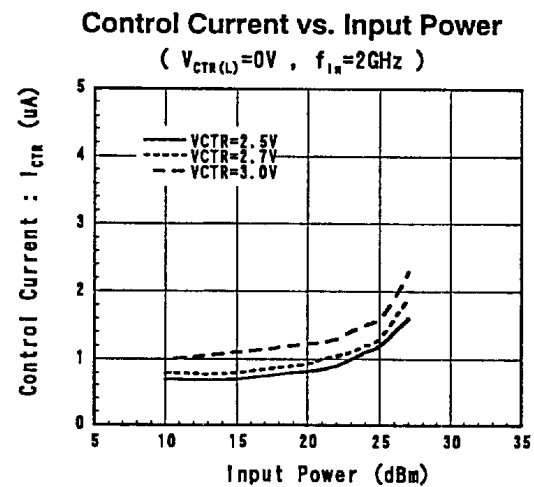
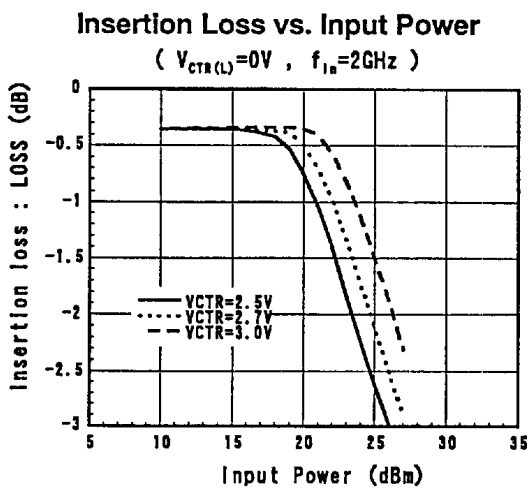
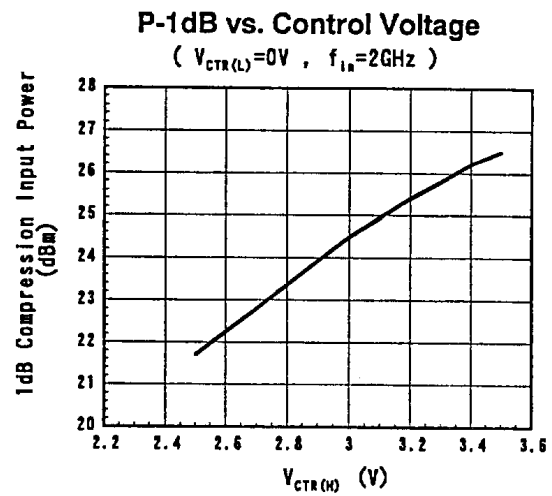
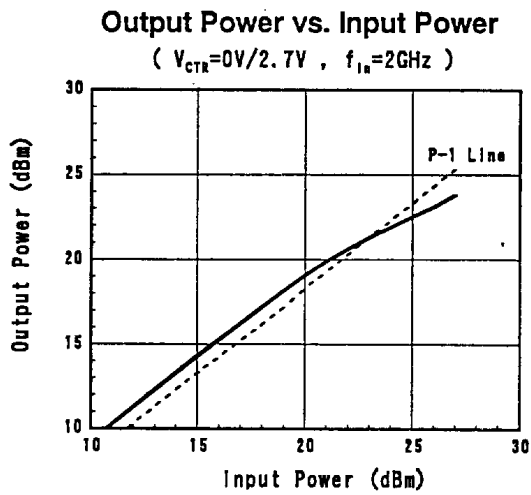
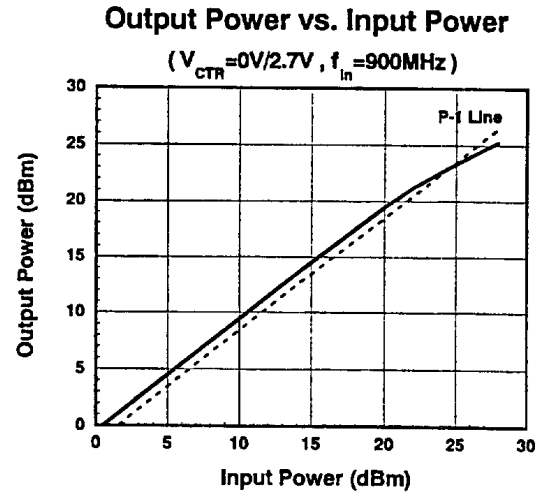
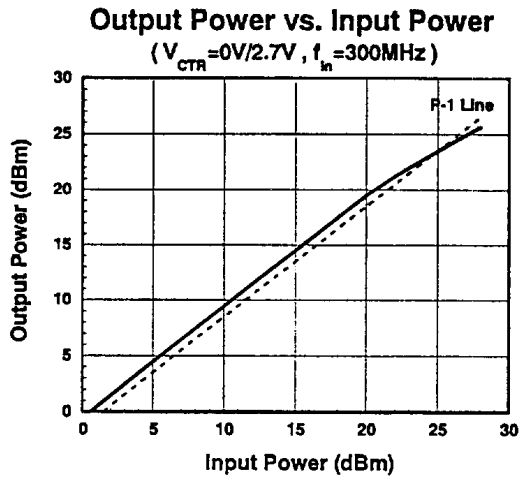



CHARACTERISTICS

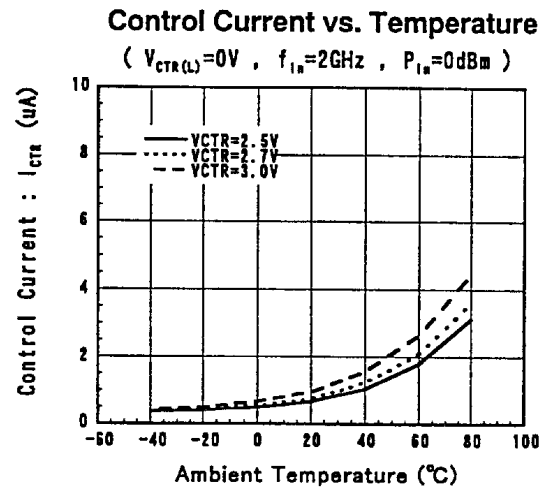
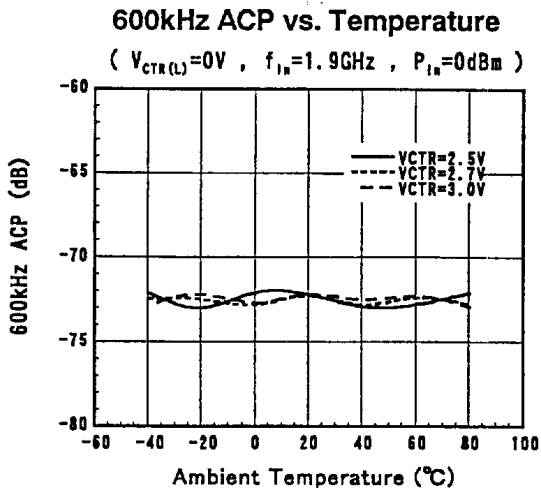
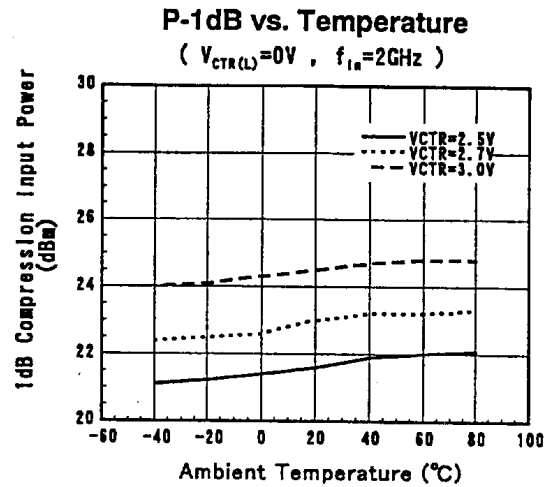
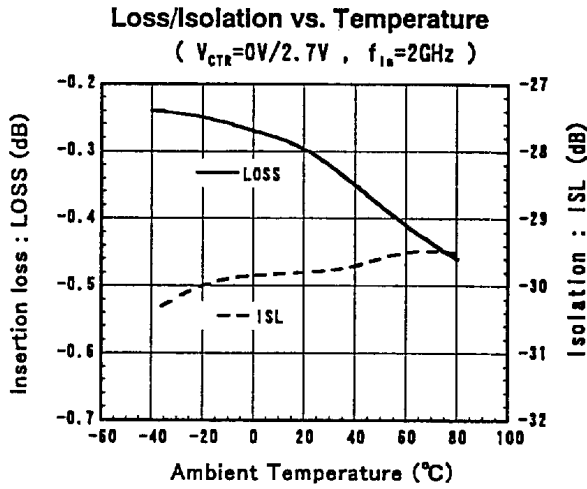



■ CHARACTERISTICS

Harmonics (Ta=25°C)
f_{in}=1.9GHz P_{in}=0dBm V_{CTR(40)}=2.7V

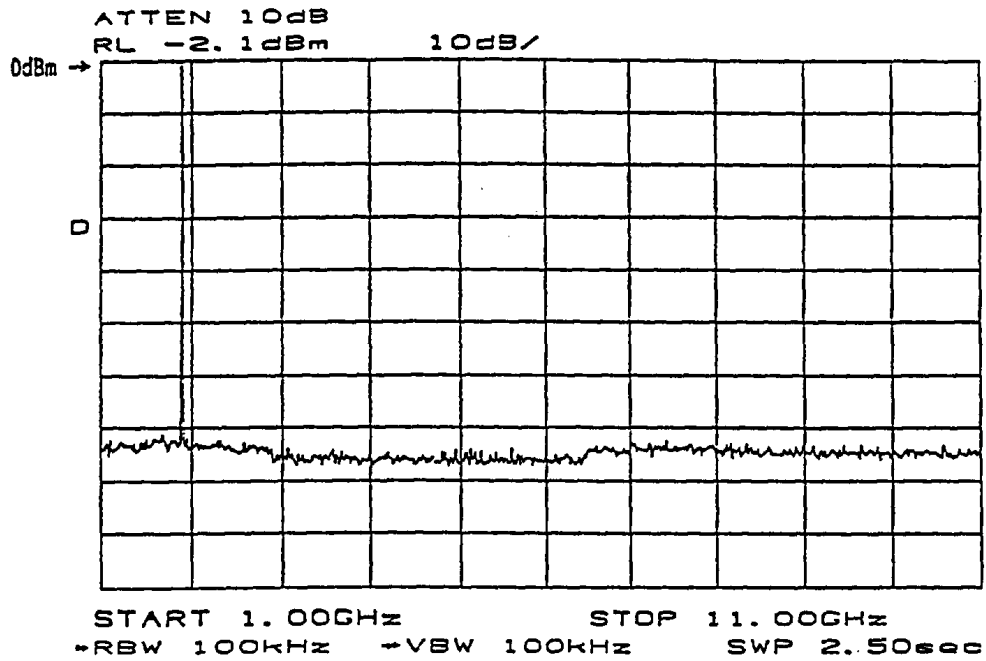



■ TYPICAL CHARACTERISTICS

P1 PORT IMPEDANCE (OFF STATE)

REF 1.0 Units
 2 200.0 mUnits/
 ∇ 6.2329 Ω 2.0117 Ω

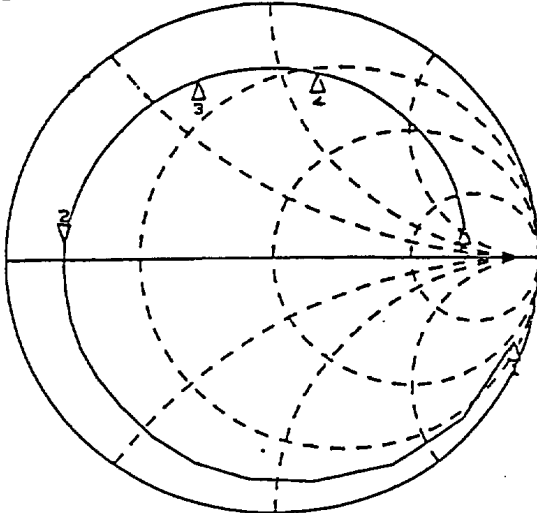

START 0.050000000 GHz
 STOP 3.000000000 GHz

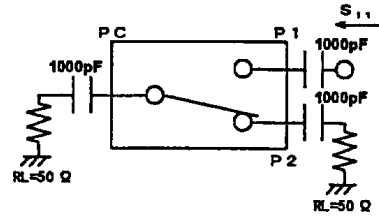

MARKER	f (MHz)	Mag.	Ang. (∠°)
1	50	0.957	-20.2
2	800	0.782	171.2
3	1500	0.759	102.0
4	2000	0.747	61.8
5	3000	0.710	-11.3

P2 PORT IMPEDANCE (OFF STATE)

REF 1.0 Units
 2 200.0 mUnits/
 ∇ 6.8921 Ω 511.47 mΩ

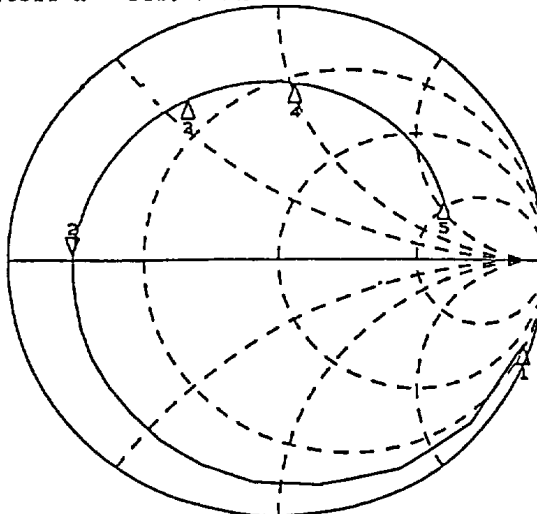

START 0.050000000 GHz
 STOP 3.000000000 GHz

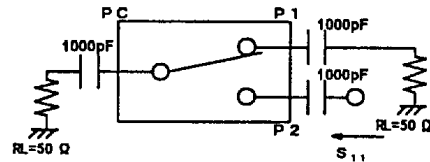

MARKER	f (MHz)	Mag.	Ang. (∠°)
1	50	0.968	-20.2
2	800	0.782	174.5
3	1500	0.749	108.2
4	2000	0.734	69.5
5	3000	0.690	-1.2

New Japan Radio Co., Ltd.



Scattering Parameters : S11(OFF STATE)
(VCTR=0/2.7V , 50Ω System)

f(MHz)	P1 PORT		P2 PORT	
	Mag.	Ang.(∠°)	Mag.	Ang.(∠°)
50	0.957	-20.2	0.968	-20.2
100	0.942	-39.5	0.954	-39.3
200	0.902	-74.0	0.911	-73.7
300	0.866	-102.8	0.871	-102.0
400	0.836	-126.1	0.840	-124.8
500	0.815	-145.4	0.818	-143.7
600	0.800	-161.8	0.801	-159.5
700	0.791	-176.1	0.790	-173.3
800	0.782	171.2	0.782	174.5
900	0.778	159.6	0.775	163.2
1000	0.772	148.6	0.769	152.8
1100	0.758	138.0	0.757	142.6
1200	0.763	128.8	0.758	133.9
1300	0.762	119.6	0.756	125.0
1400	0.761	110.7	0.752	116.5
1500	0.759	102.0	0.749	108.2
1600	0.756	93.8	0.747	100.3
1700	0.753	85.7	0.744	92.5
1800	0.753	77.6	0.741	84.7
1900	0.750	69.6	0.738	77.0
2000	0.747	61.8	0.734	69.5
2100	0.744	54.4	0.730	62.5
2200	0.744	46.6	0.730	55.0
2300	0.740	39.1	0.723	47.6
2400	0.739	31.8	0.720	40.5
2500	0.733	24.4	0.719	33.4
2600	0.729	17.3	0.711	26.3
2700	0.727	10.3	0.707	19.8
2800	0.722	2.9	0.701	12.5
2900	0.715	-4.2	0.695	5.6
3000	0.710	-11.3	0.690	-1.2



■ APPLICATION CIRCUIT1 : Single signal control circuit using C-MOS inverter

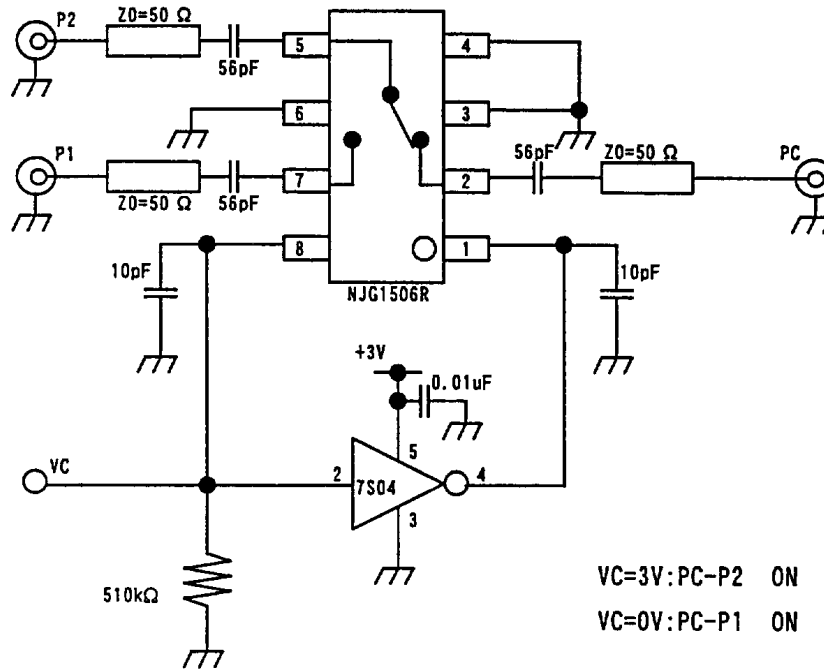

- [1] Please connect the bypass capacitor to C-MOS inverter supply terminal.
- [2] In order to the state of input impedance of inverter, please pull-down with 510k Ω of resistor for C-MOS inverter input terminal.

■ APPLICATION CIRCUIT2 : Single signal control circuit using a transistor.

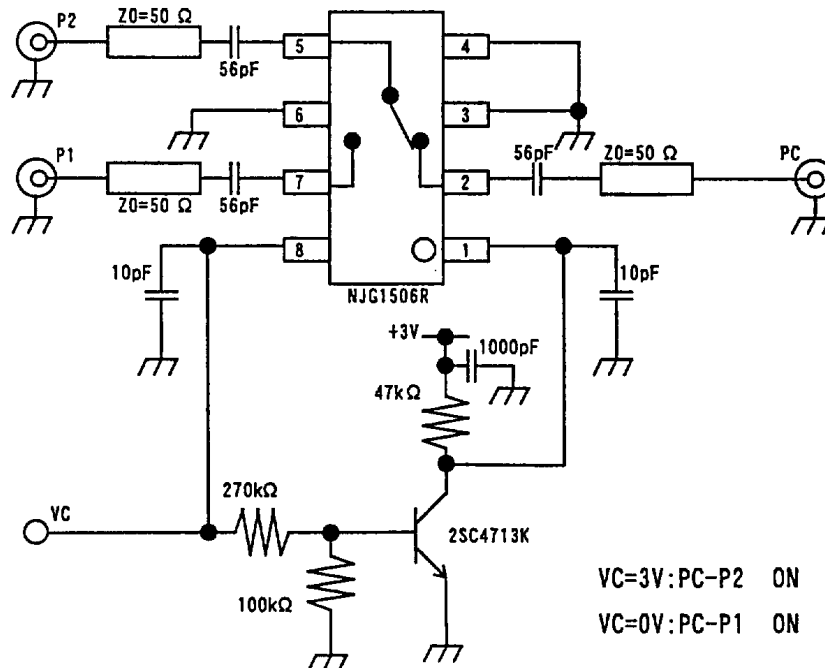

New Japan Radio Co., Ltd.



■ TEST CIRCUIT

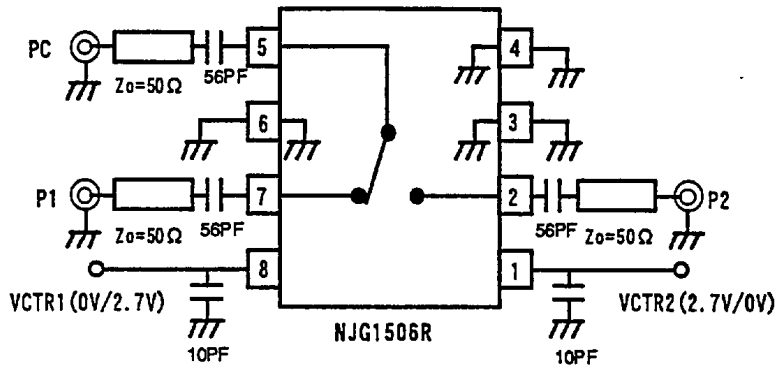

■ RECOMMENDED PCB

(TOP VIEW)

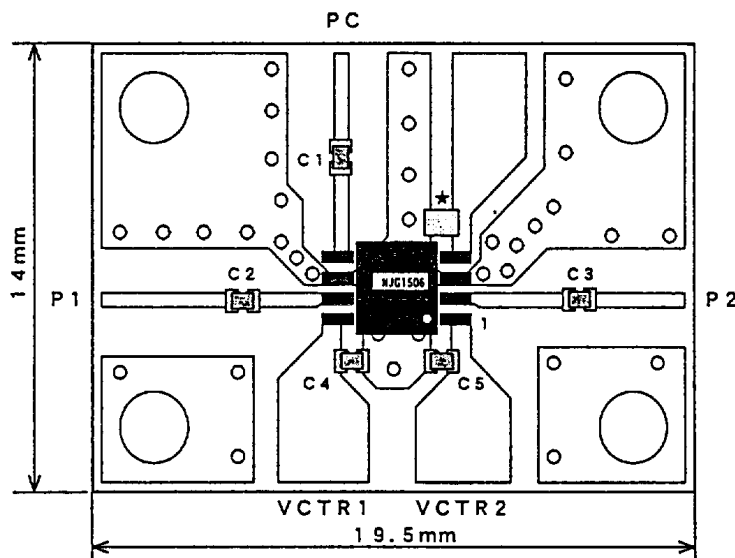

PCB:FR-4 t=0.2mm

CAPACITOR:size 1005

STRIP LINE WIDTH=0.5mm

C1~C3:56pF

C4, C5:10pF

★:Please short between Pin4 and ground near IC

Usage precaution on devices

- [1] Outer capacitors should be connected to the input and output RF frequency terminal(P1,P2,PC)to block the DC current. The above figure is a circuit's example to a frequency at 900MHz. Please use a capacitor from 10pF to 1000pF to be suited for using band.
- [2] Decoupling capacitors should be connected to the control terminals(V_{CTR1},V_{CTR2}) as near as possible. The values of these capacitors should be selected from 5pF to 100pF for using band. But take care of the switching time because the capacitor make the switching time late.
- [3] In order to keep good isolation characteristics, the ground terminal (3,4,6 pin)should be connected to ground pattern with relatively wide width as near as possible, and Though-hole in the ground plane should be placed as near as possible too.

New Japan Radio Co.,Ltd.

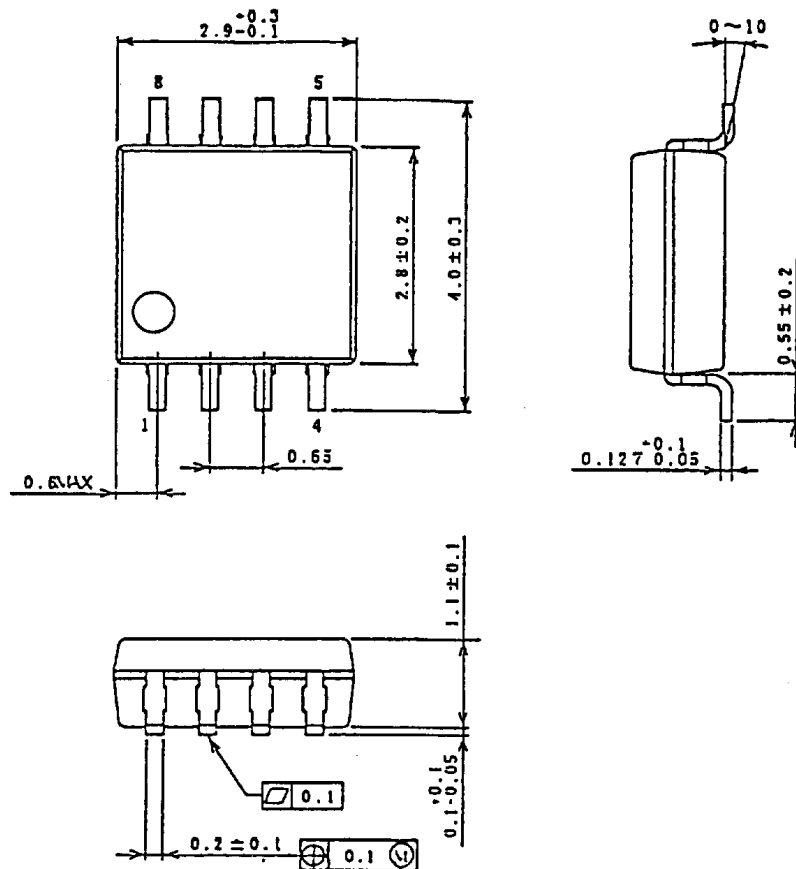
■ PACKAGE OUTLINE

UNIT:mm

Caution on using the products

A GaAs is used in this products. A GaAs is a harmful material.

- Don't eat or in the mouth.
- Don't dispose in fire or break up the products.
- Don't be make a gas or a powdered with the chemical reaction.
- In the case of wasting the products, please obey the relation rule in the each country.
- This products may be broken with static electric discharge or serge voltage. Therefore, please note a handling.

This products may be broken with static electric discharge or serge voltage. Therefore, please note a handling.

- The product specifications and descriptions listed in this catalog are subject to change at any time, without notice.
 - It is to modify the details of this catalog without making any preliminary announcement.
 - We don't take upon ourselves the responsibilities that infringe on other people's rights of a patents bringing about the information and drawing in this catalog.
 - It is not purpose to be equipped with the system needs a high reliability as air system, submarine cable system, atomic energy control system and medical instrument for keeping life.
- If you think the above system, please ask for the sales office beforehand.

New Japan Radio Co., Ltd.