

DPDT SWITCH GaAs MMIC

■GENERAL DESCRIPTION

NJG1524PC1 is a DPDT switch GaAs MMIC.

The two same switches are merged into one package and functionally linked. It is useful for switching two circuits in-line.

Each switches feature very low loss, high isolation and wide frequency coverage from 50MHz to 3GHz at low control voltage of 2.5V.

The ultra small & thin FFP16-C1package is adopted.

■PACKAGE OUTLINE



NJG1524PC1

■FEATURES

- Single low voltage control +2.5~+6.5V
- Low insertion loss 0.3dB typ. @f=1GHz, P_{IN}=0dBm, each switch
0.5dB typ. @f=2GHz, P_{IN}=0dBm, each switch
- High isolation 42dB typ. @f=2GHz, PC1-PC2
27dB typ. @f=2GHz, PC1-PA1 PC1-PA2, PC2-PB1,
PC2-PB2, PA1-PA2, PB1-PB2
- Handling power 20dBm max. @f=2GHz, V_{CTL}=2.7V
- Low current consumption 16uA typ. @f=2GHz, P_{IN}=10dBm
- Ultra small & thin package FFP16-C1 (Package size: 2.5x2.5x0.85mm)

■PIN CONFIGURATION

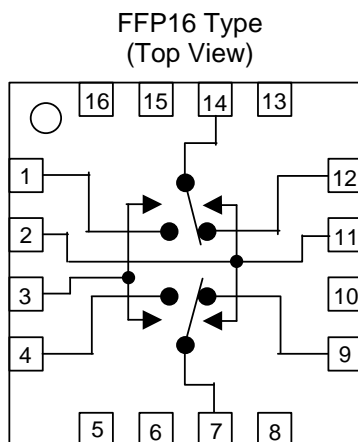

Pin Connection

- 1.PA2 9.PB1
- 2.VCTL1 10.NC
- 3.VCTL2 11.VCTL1
- 4.PB2 12.PA1
- 5.GND 13.GND
- 6.GND 14.PC1
- 7.PC2 15.GND
- 8.GND 16.GND

■TRUTH TABLE

“ H ” =V_{CTL (H)}, “ L ” =V_{CTL (L)}

VCTL1	H	L
VCTL2	L	H
PC1 – PA1 PC2 – PB1	ON	OFF
PC1 – PA2 PC2 – PB2	OFF	ON

NOTE: Please note that any information on this catalog will be subject to change.

NJG1524PC1

■ABSOLUTE MAXIMUM RATINGS

				(T _a =25°C)
PARAMETER	SYMBOL	CONDITIONS	RATINGS	UNITS
Input Power	P _{IN}	V _{CTL(L)} =0V, V _{CTL(H)} =2.7V	28	dBm
Control voltage	V _{CTL}	V _{CTL(H)} - V _{CTL(L)}	7.5	V
Power Dissipation	P _D		400	mW
Operating Temp.	T _{opr}		-40~+85	°C
Storage Temp.	T _{stg}		-55~+125	°C

■ELECTRICAL CHARACTERISTICS (EACH SWITCH)

							(V _{CTL(L)} =0V, V _{CTL(H)} =2.7V, Z _S =Z _O =50Ω, T _a =25°C)
PARAMETER	SYMBOL	CONDITIONS	MIN	TYP	MAX	UNITS	
Operating voltage (L)	V _{CTL(L)}		-0.2	0	0.2	V	
Operating voltage (H)	V _{CTL(H)}		2.5	2.7	6.5	V	
Control Current	I _{CTL}	f=2GHz, P _{IN} =10dBm	-	16	28	uA	
Insertion loss1	Loss1	PC1-PA1, PC1-PA2, PC2-PB1, PC2-PB2 ON, f=1GHz, P _{IN} =0dBm	-	0.3	0.6	dB	
Insertion loss2	Loss2	PC1-PA1, PC1-PA2, PC2-PB1, PC2-PB2 ON, f=2GHz, P _{IN} =0dBm	-	0.5	0.8	dB	
Isolation1	ISL1	PC1-PA1, PC1-PA2, PC2-PB1, PC2-PB2 OFF, f=1GHz, P _{IN} =0dBm	25.5	27	-	dB	
Isolation2	ISL2	PC1-PA1, PC1-PA2, PC2-PB1, PC2-PB2 OFF, f=2GHz, P _{IN} =0dBm	25	27	-	dB	
Isolation3	ISL3	PA1, PA2, PB1, PB2 port 50Ω terminal, PC1-PC2 port, f=2GHz, P _{IN} =0dBm	39	42	-	dB	
Pin at 1dB compression point	P _{-1dB}	f=2GHz	20	24	-	dBm	
VSWR (PC, P1, P2)	VSWR	f=0.05~2GHz, ON State	-	1.3	1.6		
Switch time	T _{SW}	f=0.05~2.5GHz	-	20	60	ns	

■ TERMINAL INFORMATION

No.	SYMBOL	DESCRIPTIONS
1	PA2	RF port A2. This port is connected with PC1 port by controlling $V_{CTL(L)}$ to $-0.2\sim+0.2V$ and $V_{CTL(H)}$ to $2.5\sim6.5V$. In order to block the DC bias voltage of internal circuit, an external capacitor is required.
2	VCTL1	Control port 1. The voltage of this port controls PC1 to PA1/PA2 and PC2 to PB1/PB2 state. The 'ON' and 'OFF' state is toggled by controlling voltage of this terminal to high-state ($2.5\sim6.5V$) or low-state ($-0.2\sim+0.2V$). The voltage of VCTL2 should be set to opposite state. The bypass capacitor should be connected with GND as close as possible for excellent RF performance.
3	VCTL2	Control port 2. The voltage of this port controls PC1 to PA1/PA2 and PC2 to PB1/PB2 state. The 'ON' and 'OFF' state is toggled by controlling voltage of this terminal to high-state ($2.5\sim6.5V$) or low-state ($-0.2\sim+0.2V$). The voltage of VCTL1 should be set to opposite state. The bypass capacitor should be connected with GND as close as possible for excellent RF performance.
4	PB2	RF port B2. This port is connected with PC2 port by controlling VCTL1 to $-0.2\sim+0.2V$ and VCTL2 to $2.5\sim6.5V$. In order to block the DC bias voltage of internal circuit, an external capacitor is required.
7	PC2	Common RF port C2. In order to block the DC bias voltage of internal circuit, an external capacitor is required.
9	PB1	RF port B1. This port is connected with PC1 port by controlling VCTL2 to $-0.2\sim+0.2V$ and VCTL1 to $2.5\sim6.5V$. In order to block the DC bias voltage of internal circuit, an external capacitor is required.
10	NC	No connected terminal.
11	VCTL1	Control port 1. The voltage of this port controls PC1 to PA1/PA2 and PC2 to PB1/PB2 state. The 'ON' and 'OFF' state is toggled by controlling voltage of this terminal to high-state ($2.5\sim6.5V$) or low-state ($-0.2\sim+0.2V$). The voltage of V_{CTL2} should be set to opposite state. The bypass capacitor should be connected with GND as close as possible for excellent RF performance.
12	PA1	RF port A1. This port is connected with PC1 port by controlling VCTL2 to $-0.2\sim+0.2V$ and VCTL1 to $2.5\sim6.5V$. In order to block the DC bias voltage of internal circuit, an external capacitor is required.
14	PC1	Common RF port C1. In order to block the DC bias voltage of internal circuit, an external capacitor is required.
5, 6, 8, 13, 15, 16	GND	Ground terminal. Please connect this terminal with ground plane as close as possible for excellent RF performance.

NJG1524PC1

■ **TYPICAL CHARACTERISTICS** (50MHz~3GHz, with application circuit, without DC blocking capacitor, losses of circuit are excluded.)

PC1-PA1 Insertion Loss vs. Frequency

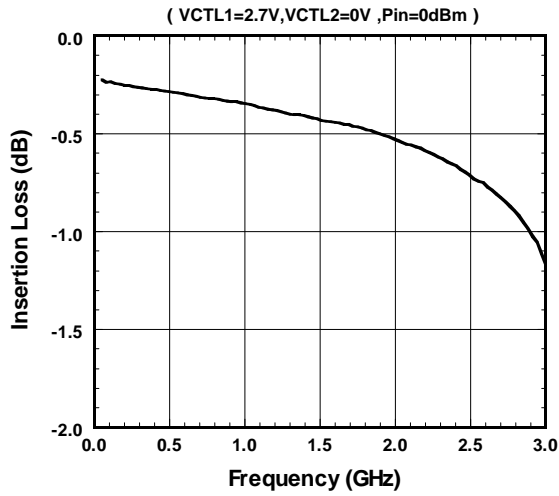

PC1-PA2 Insertion Loss vs. Frequency

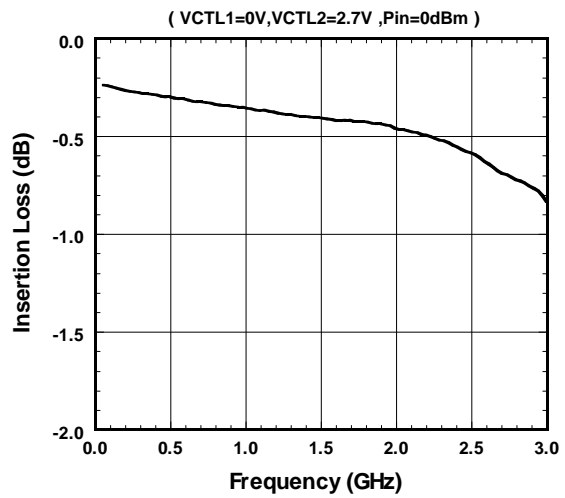

PC2-PB1 Insertion Loss vs. Frequency

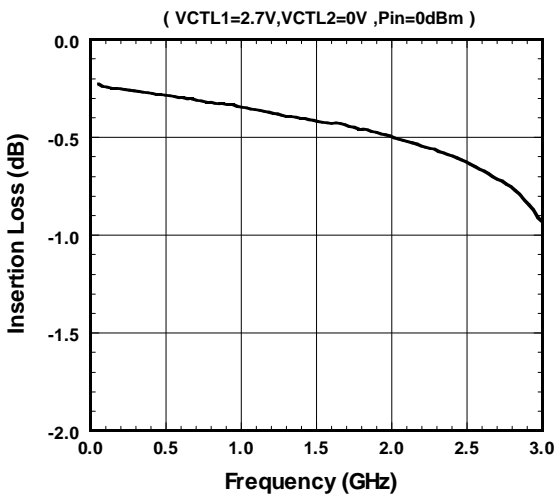

PC2-PB2 Insertion Loss vs. Frequency

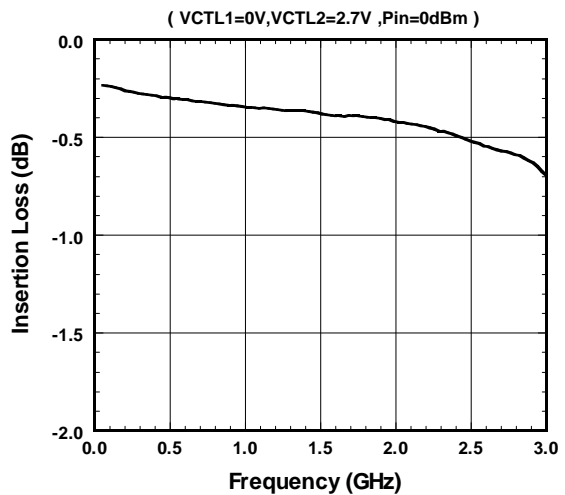

PC1-PA1 Isolation vs. Frequency

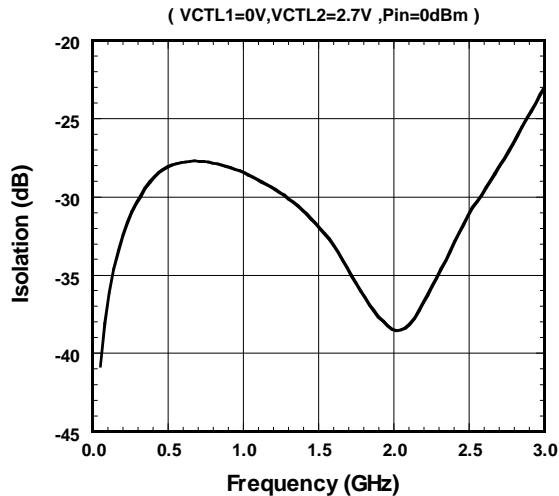

PC1-PA2 Isolation vs. Frequency

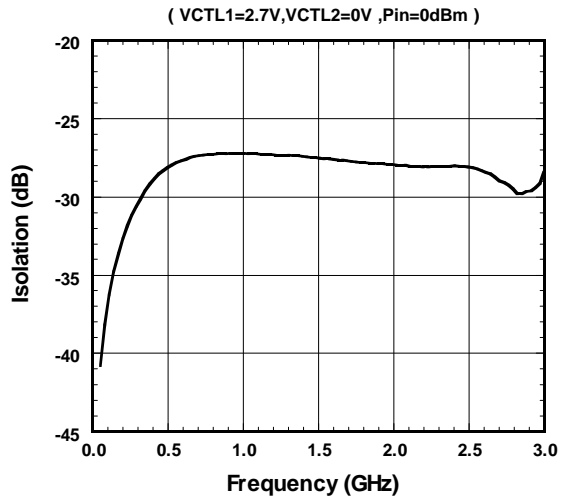

■ **TYPICAL CHARACTERISTICS** (50MHz~3GHz, with application circuit, without DC blocking capacitor, losses of circuit are excluded.)

PC2-PB1 Isolation vs. Frequency

(VCTL1=0V,VCTL2=2.7V ,Pin=0dBm)

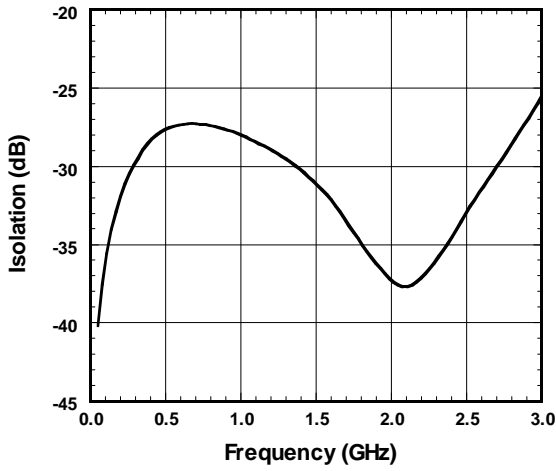

PC2-PB2 Isolation vs. Frequency

(VCTL1=2.7V,VCTL2=0V ,Pin=0dBm)

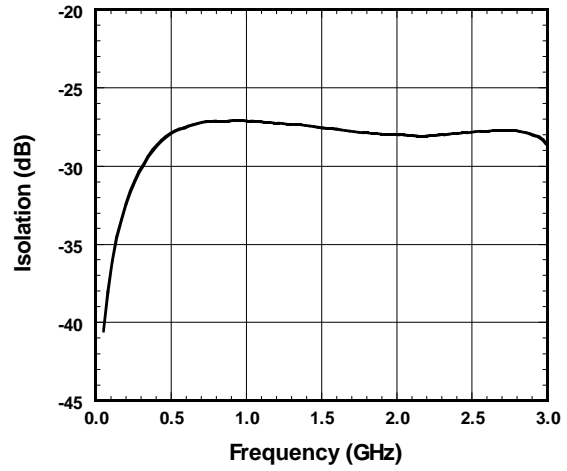

PA1-PA2 Isolation vs. Frequency

(VCTL1=2.7V,VCTL2=0V ,Pin=0dBm)

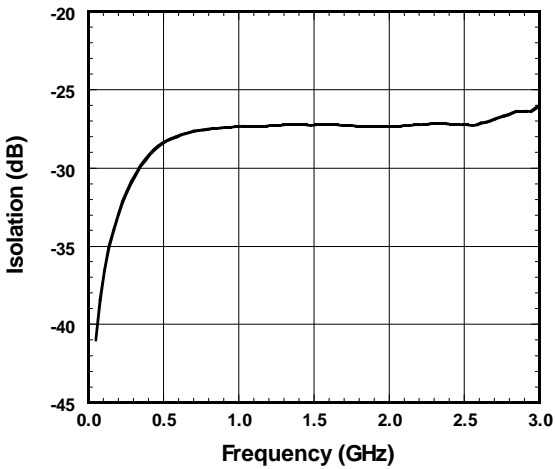

PB1-PB2 Isolation vs. Frequency

(VCTL1=2.7V,VCTL2=0V ,Pin=0dBm)

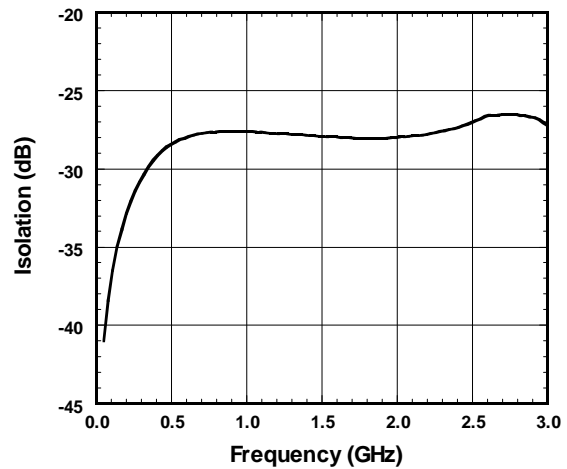

PC1-PC2 Isolation vs. Frequency

(VCTL1=2.7V,VCTL2=0V ,Pin=0dBm)

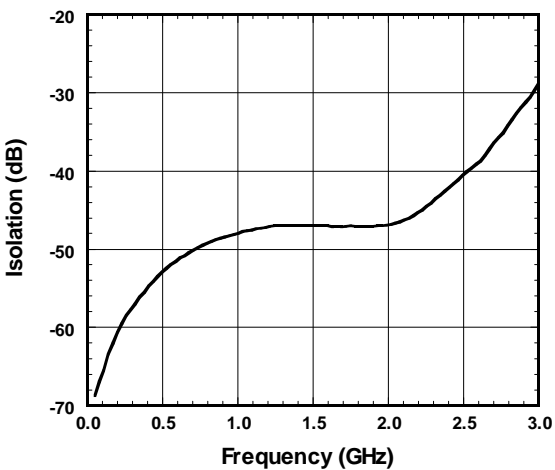

PC1-PA1(on) VSWR vs. Frequency

(VCTL1=2.7V,VCTL2=0V,PC1 port)

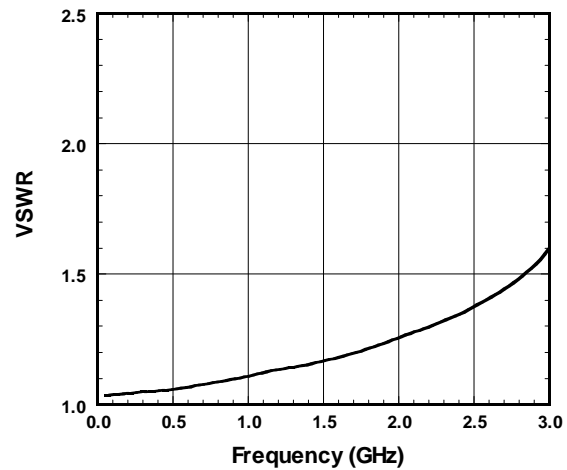

NJG1524PC1

■ TYPICAL CHARACTERISTICS (50MHz~3GHz, with application circuit, without DC blocking capacitor, losses of circuit are excluded.)

PC1-PA2(on) VSWR vs. Frequency

(VCTL1=0V,VCTL2=2.7V,PC1 port)

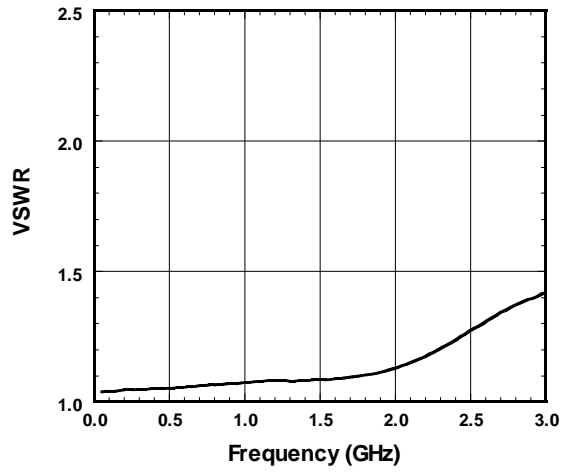

PC2-PB1(on) VSWR vs. Frequency

(VCTL1=2.7V,VCTL2=0V,PC2 port)

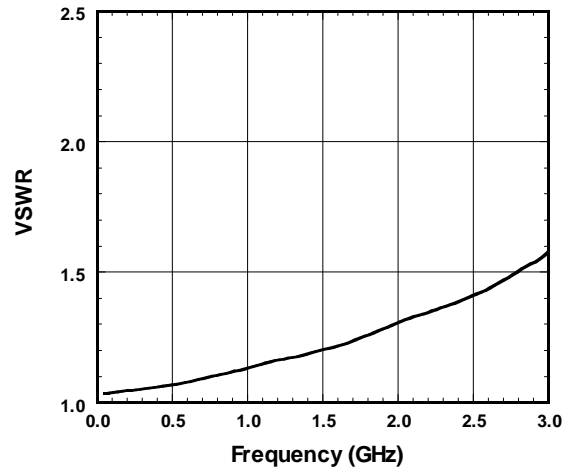

PC2-PB2(on) VSWR vs. Frequency

(VCTL1=0V,VCTL2=2.7V,PC2 port)

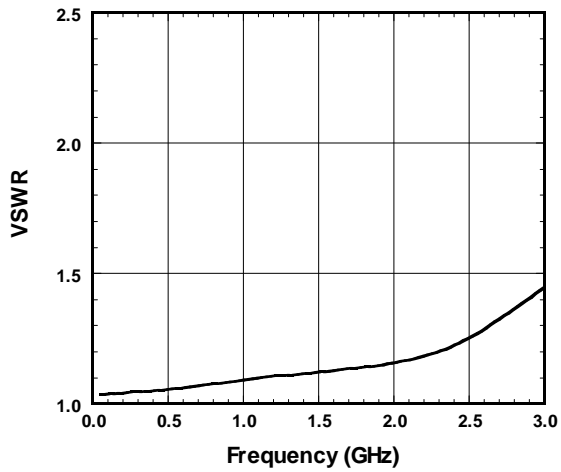

■ **TYPICAL CHARACTERISTICS** (50MHz~100MHz, with application circuit, losses of PCB, connector and DC blocking capacitor (0.01uF) are included.)

PC1-PA1 Insertion Loss vs. Frequency

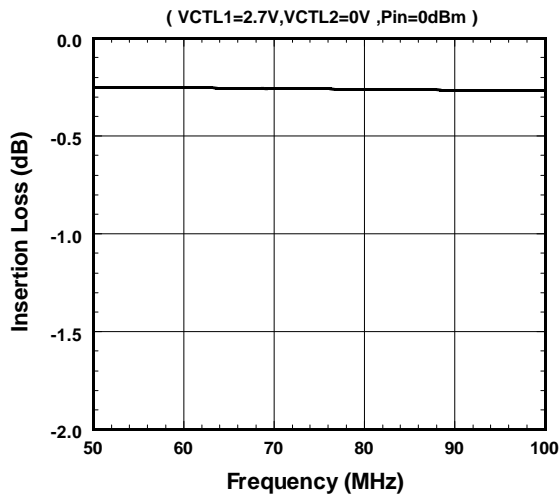

PC1-PA2 Insertion Loss vs. Frequency

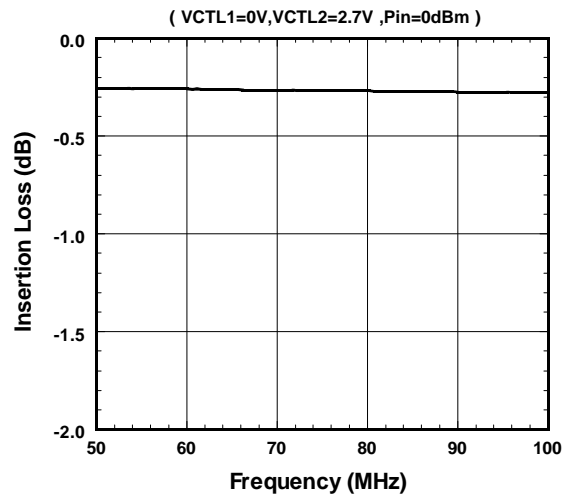

PC2-PB1 Insertion Loss vs. Frequency

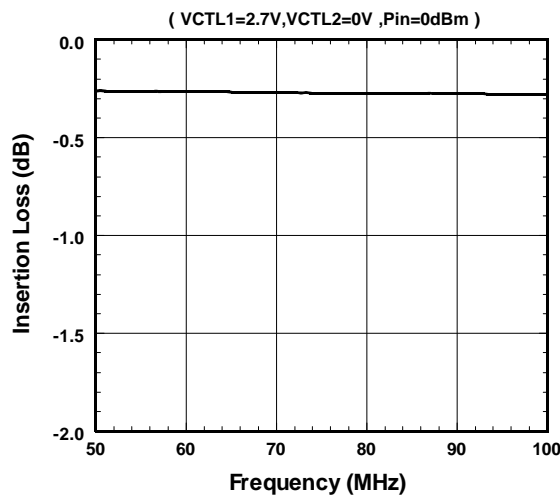

PC2-PB2 Insertion Loss vs. Frequency

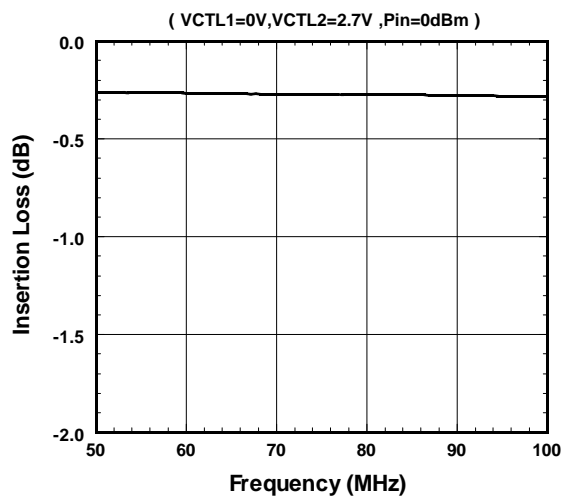

PC1-PA1 Isolation vs. Frequency

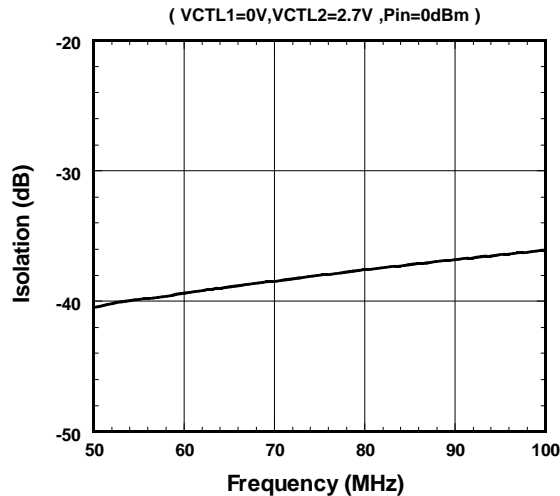

PC1-PA2 Isolation vs. Frequency

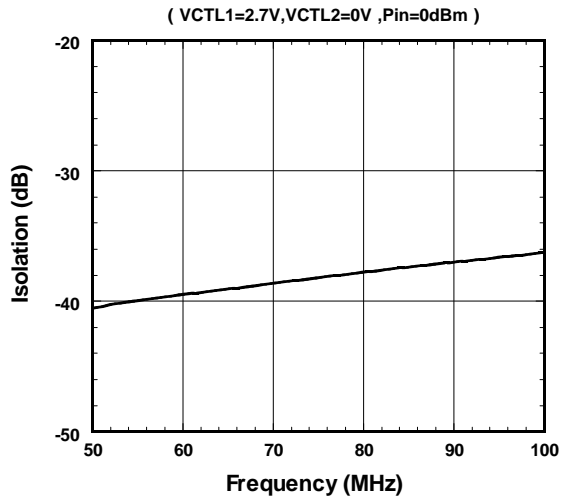

NJG1524PC1

■ **TYPICAL CHARACTERISTICS** (50MHz~100MHz, with application circuit, losses of PCB, connector and DC blocking capacitor (0.01uF) are included.)

PC2-PB1 Isolation vs. Frequency

(VCTL1=0V,VCTL2=2.7V ,Pin=0dBm)

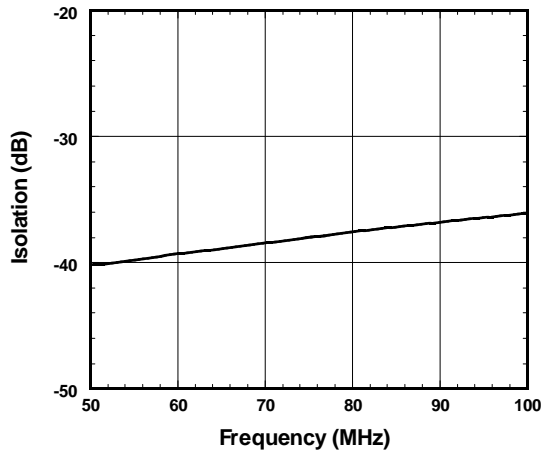

PC2-PB2 Isolation vs. Frequency

(VCTL1=2.7V,VCTL2=0V ,Pin=0dBm)

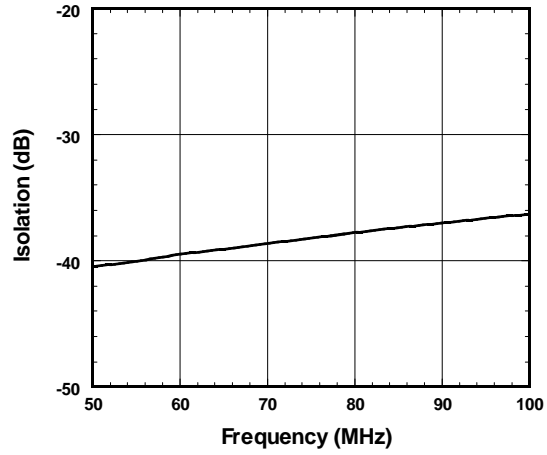

PA1-PA2 Isolation vs. Frequency

(VCTL1=2.7V,VCTL2=0V ,Pin=0dBm)

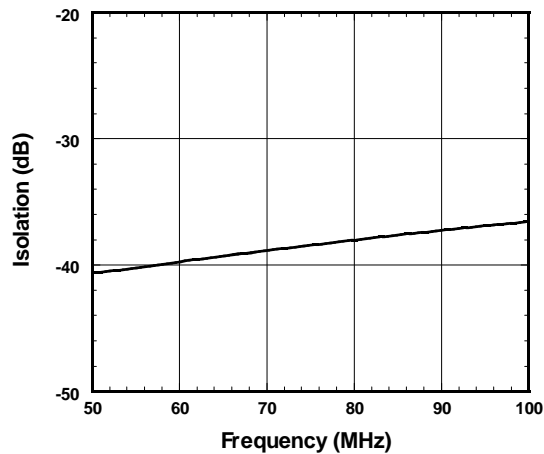

PB1-PB2 Isolation vs. Frequency

(VCTL1=2.7V,VCTL2=0V ,Pin=0dBm)

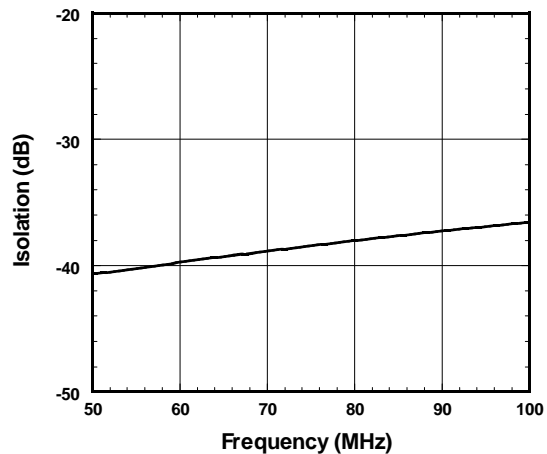

PC1-PC2 Isolation vs. Frequency

(VCTL1=2.7V,VCTL2=0V ,Pin=0dBm)

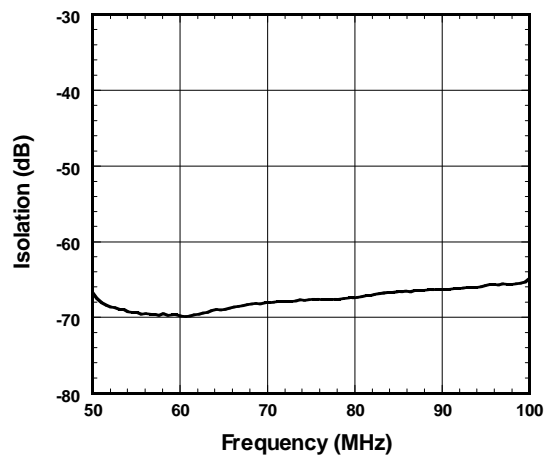

■ **TYPICAL CHARACTERISTICS** (0.1GHz~0.5GHz, with application circuit, losses of PCB, connector and DC blocking capacitor (1000pF) are included.)

PC1-PA1 Insertion Loss vs. Frequency

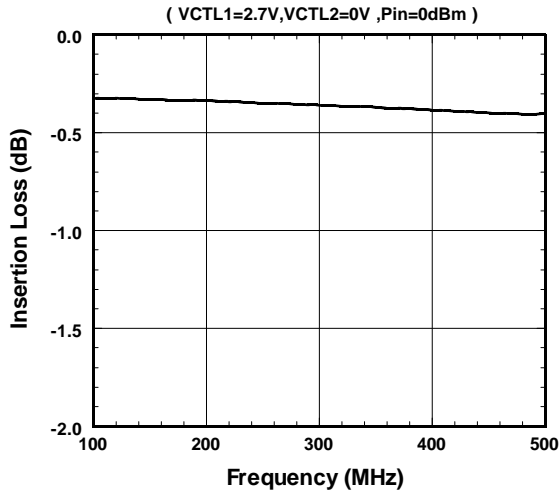

PC1-PA2 Insertion Loss vs. Frequency

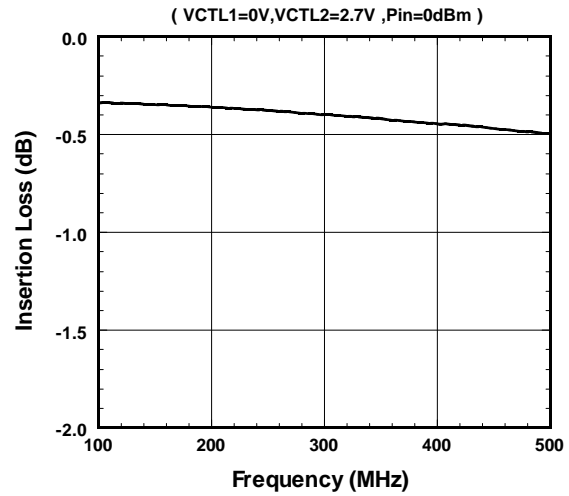

PC2-PB1 Insertion Loss vs. Frequency

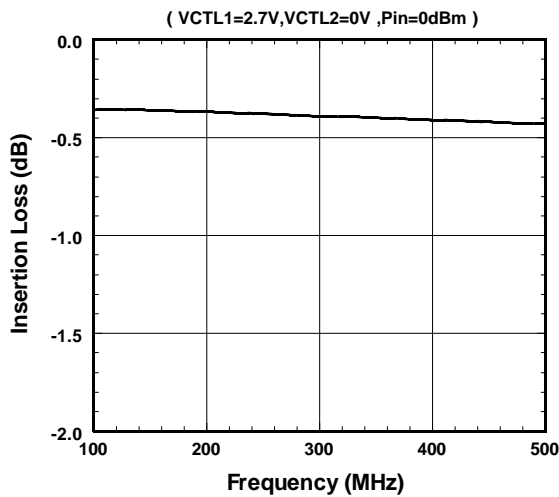

PC2-PB2 Insertion Loss vs. Frequency

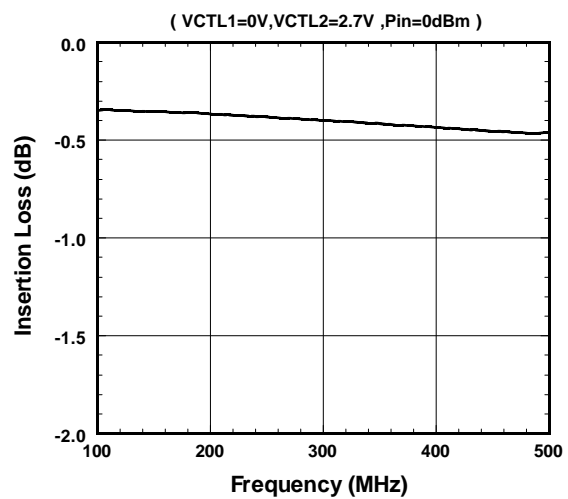

PC1-PA1 Isolation vs. Frequency

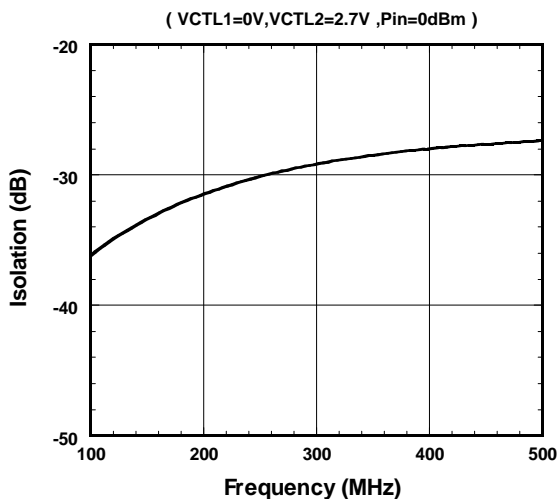

PC1-PA2 Isolation vs. Frequency

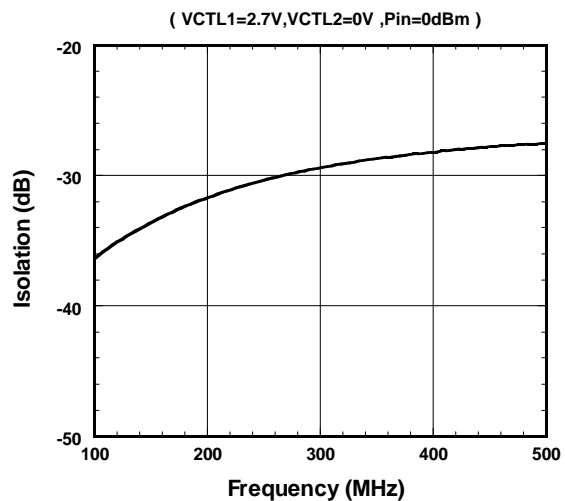

NJG1524PC1

■ **TYPICAL CHARACTERISTICS** (0.1GHz~0.5GHz, with application circuit, losses of PCB, connector and DC blocking (1000pF) are included.)

PC2-PB1 Isolation vs. Frequency

(VCTL1=0V,VCTL2=2.7V ,Pin=0dBm)

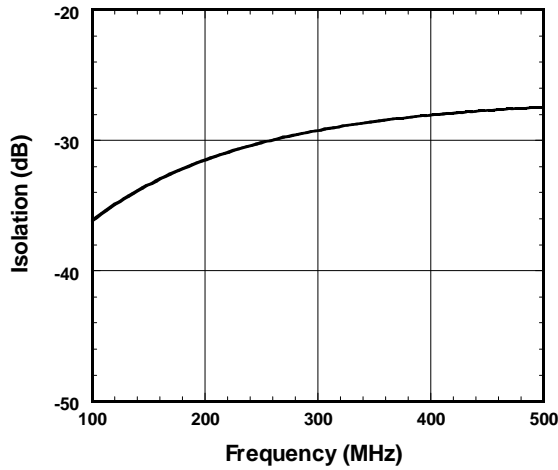

PC2-PB2 Isolation vs. Frequency

(VCTL1=2.7V,VCTL2=0V ,Pin=0dBm)

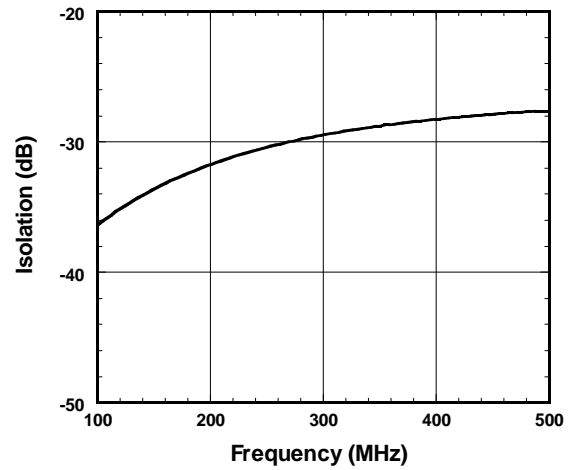

PA1-PA2 Isolation vs. Frequency

(VCTL1=2.7V,VCTL2=0V ,Pin=0dBm)

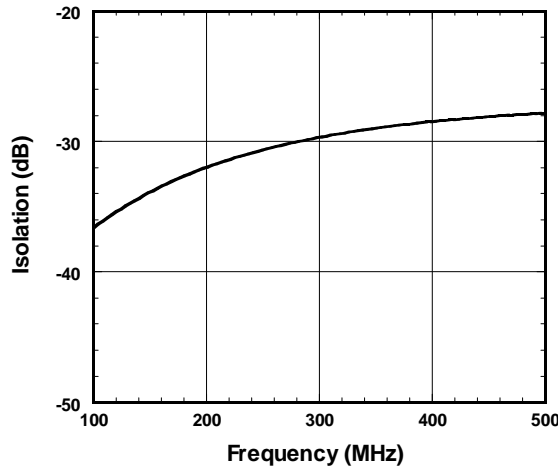

PB1-PB2 Isolation vs. Frequency

(VCTL1=2.7V,VCTL2=0V ,Pin=0dBm)

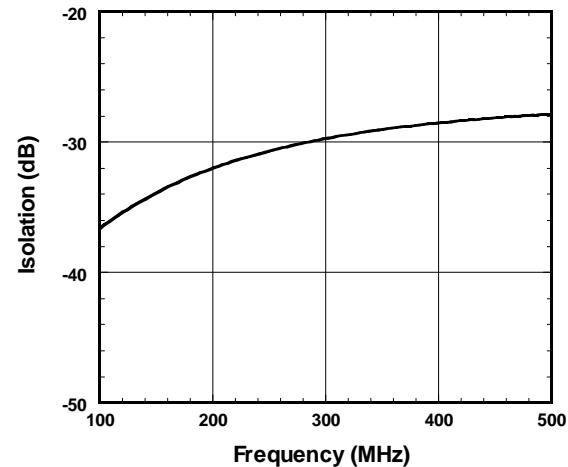

PC1-PC2 Isolation vs. Frequency

(VCTL1=2.7V,VCTL2=0V ,Pin=0dBm)

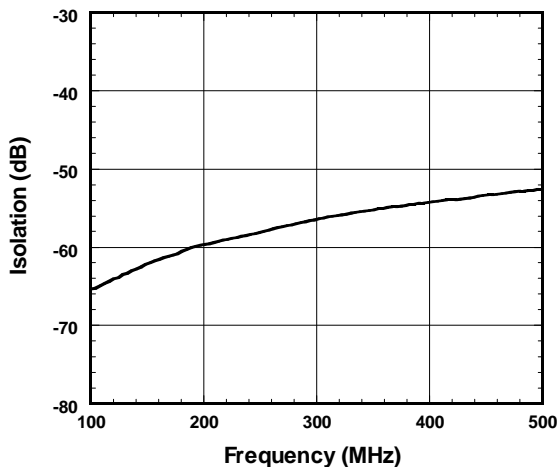

■ **TYPICAL CHARACTERISTICS** (0.5GHz~3GHz, with application circuit, losses of PCB, connector and blocking capacitor (56pF) are included.)

PC1-PA1 Insertion Loss vs. Frequency

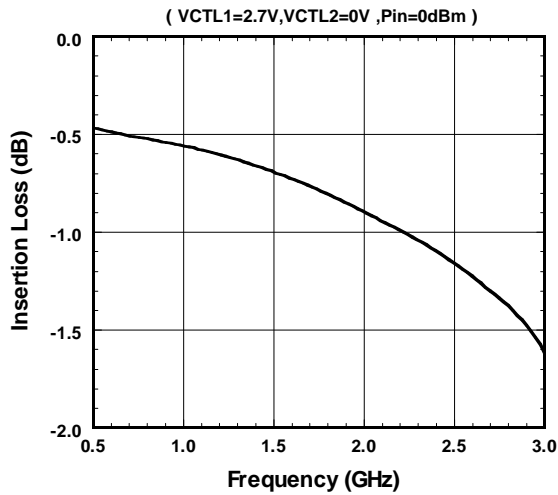

PC1-PA2 Insertion Loss vs. Frequency

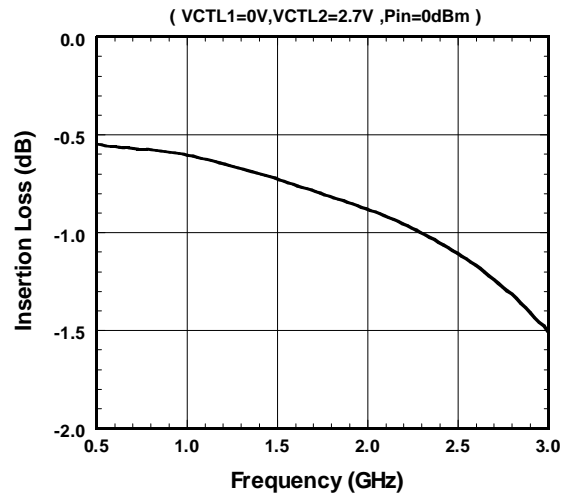

PC2-PB1 Insertion Loss vs. Frequency

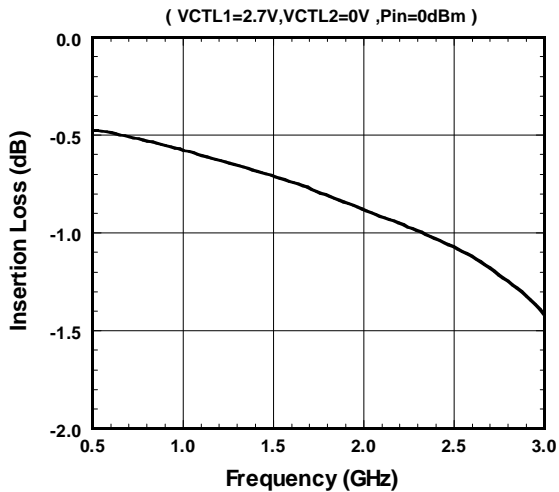

PC2-PB2 Insertion Loss vs. Frequency

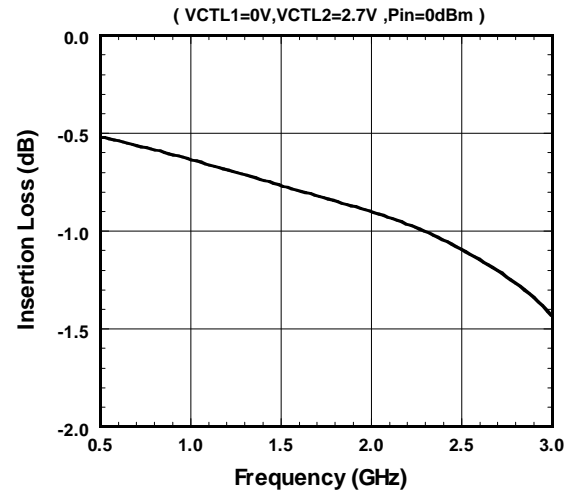

PC1-PA1 Isolation vs. Frequency

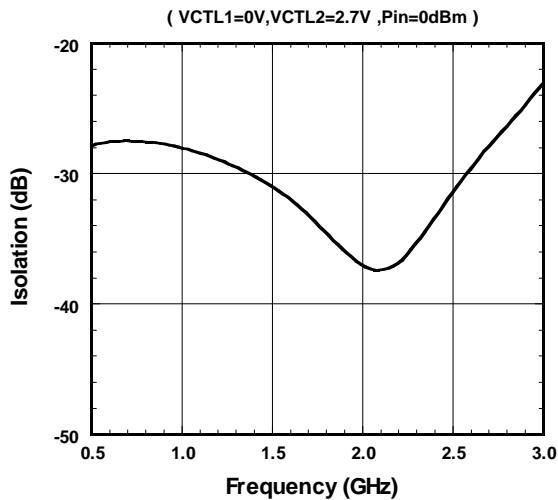

PC1-PA2 Isolation vs. Frequency

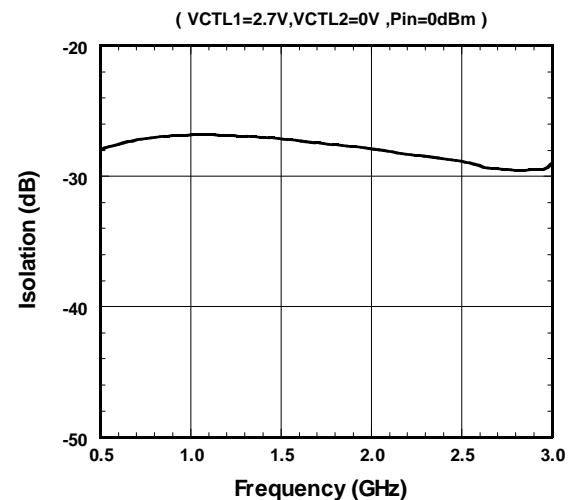

NJG1524PC1

■ **TYPICAL CHARACTERISTICS** (0.5GHz~3GHz, with application circuit, losses of PCB, connector and DC blocking capacitor (56pF) are included.)

PC2-PB1 Isolation vs. Frequency

(VCTL1=0V,VCTL2=2.7V ,Pin=0dBm)

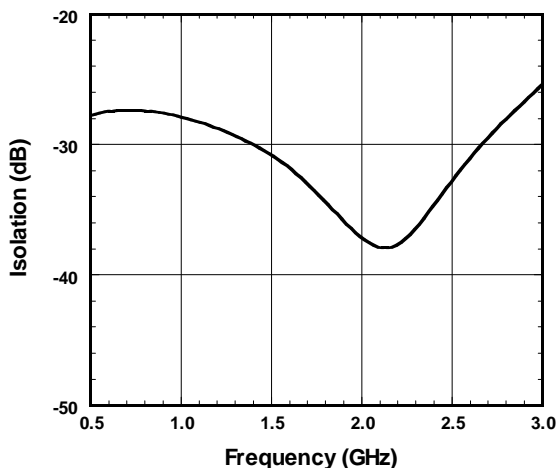

PC2-PB2 Isolation vs. Frequency

(VCTL1=2.7V,VCTL2=0V ,Pin=0dBm)

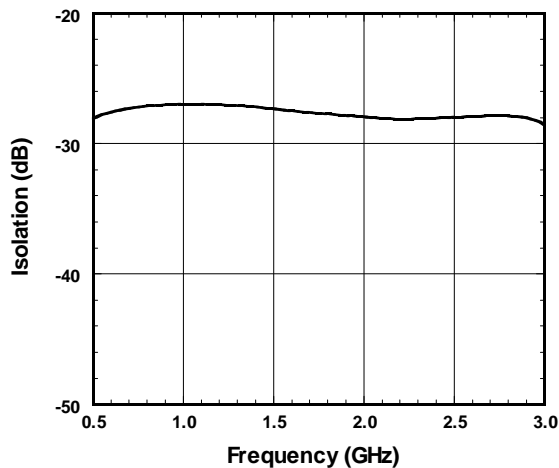

PA1-PA2 Isolation vs. Frequency

(VCTL1=2.7V,VCTL2=0V ,Pin=0dBm)

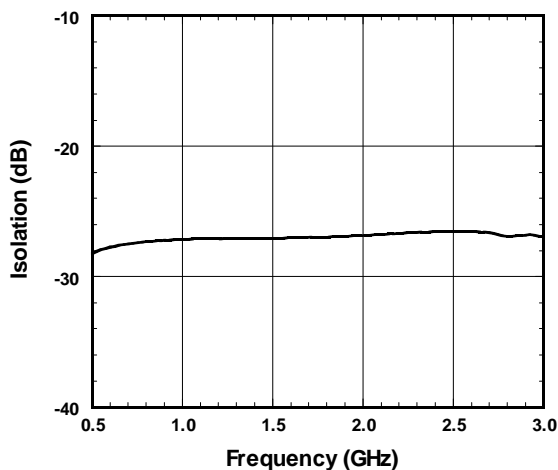

PB1-PB2 Isolation vs. Frequency

(VCTL1=2.7V,VCTL2=0V ,Pin=0dBm)

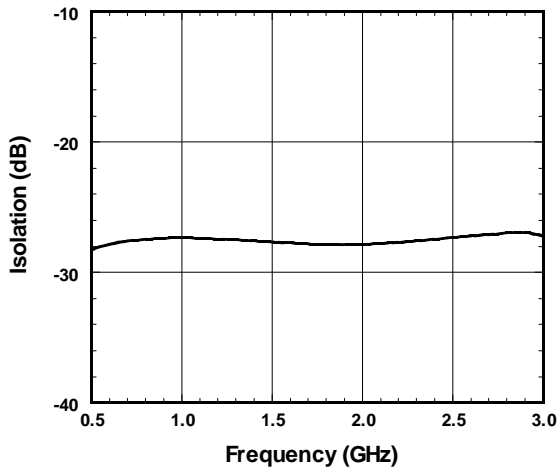

PC1-PC2 Isolation vs. Frequency

(VCTL1=2.7V,VCTL2=0V ,Pin=0dBm)

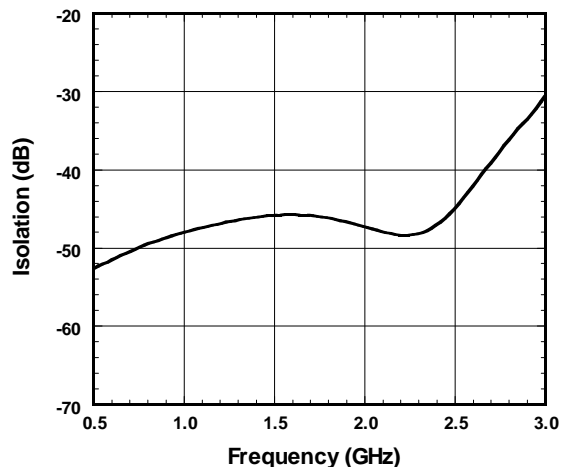

PCB Through Loss vs. Frequency

(Losses of PCB,connector and DC blocking capacitor)
(Pin=0dBm,PC1-PA1,PC2-PB1)

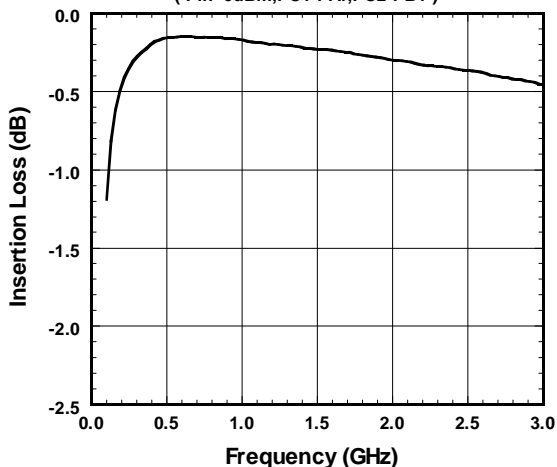

■TYPICAL CHARACTERISTICS (0.1GHz~3GHz, with application circuit, losses of PCB, connector and DC blocking capacitor (0.01uF)are included.)

PCB Through Loss vs. Frequency

(Losses of PCB,connector and DC blocking capacitor)
(Pin=0dBm,PC1-PA2,PC2-PB2)

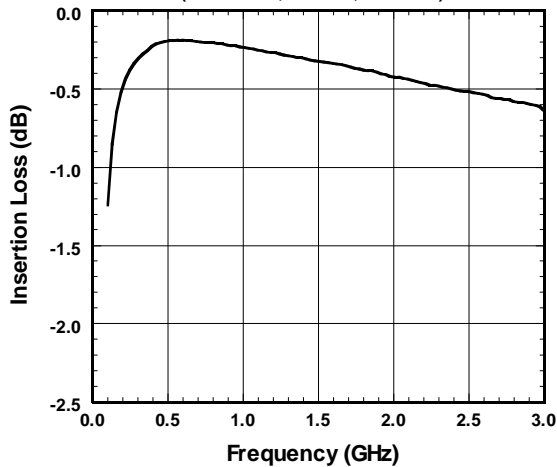

■TYPICAL CHARACTERISTICS (Parts Table3, with application circuit, losses of external circuit are excluded.)

Output Power ,Insertion Loss vs. Input Power
(PC1-PA1 ,f=1GHz)

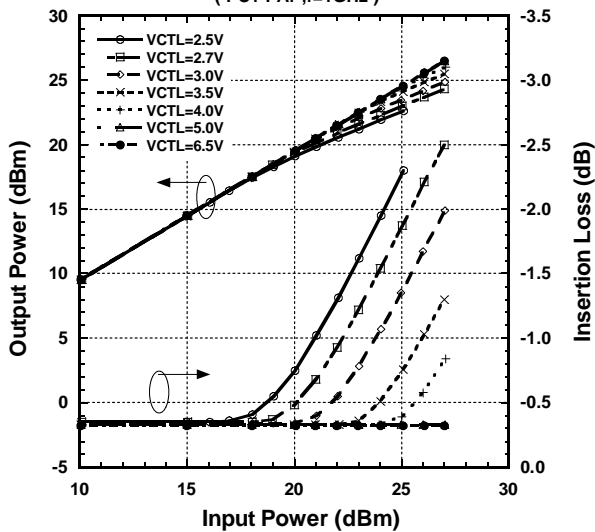

Output Power ,Insertion Loss vs. Input Power
(PC1-PA2 ,f=1GHz)

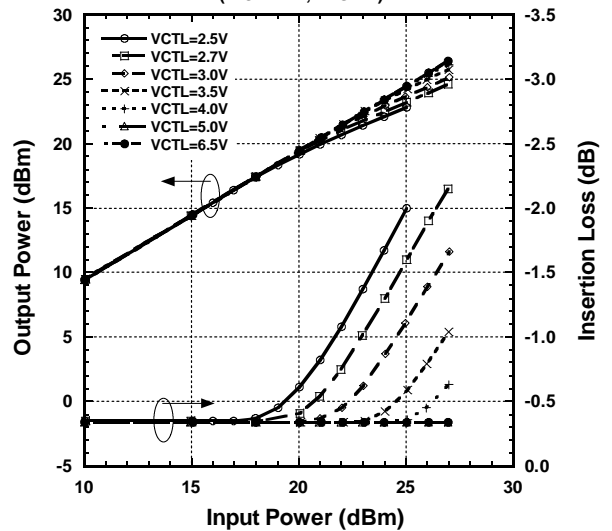

NJG1524PC1

■ **TYPICAL CHARACTERISTICS** (Parts Table3, with application circuit, losses of external circuit are excluded.)

Output Power ,Insertion Loss vs. Input Power
(PC1-PA1 ,f=2GHz)

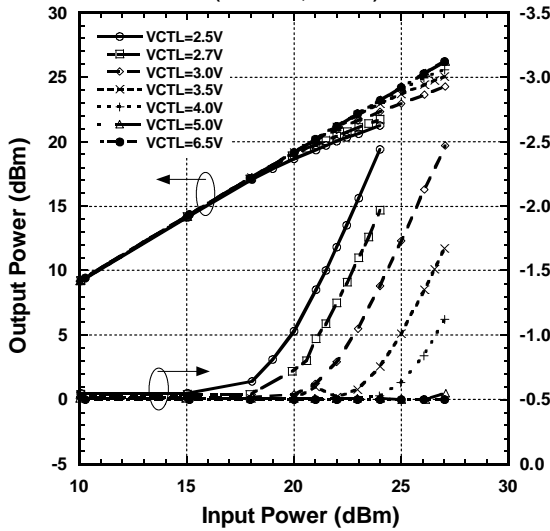

Output Power ,Insertion Loss vs. Input Power
(PC1-PA2 ,f=2GHz)

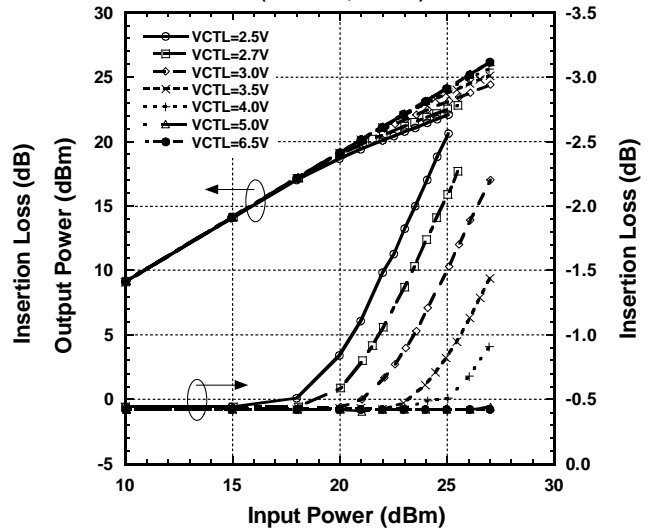

Control Current vs. Control Voltage
(PC1-PA1 ,f=1GHz ,Pin=10dBm)

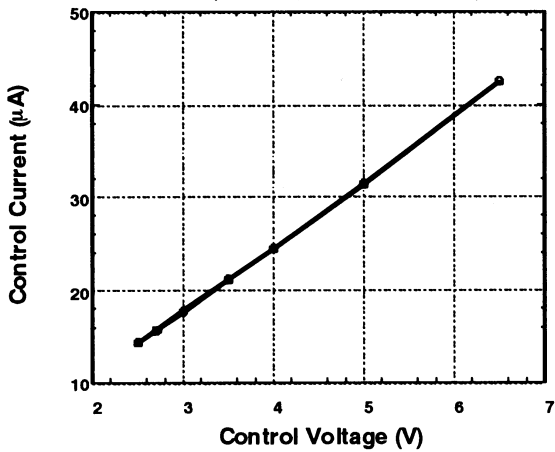

Switching Speed
(VCTL=2.7V,Pin=10dBm)

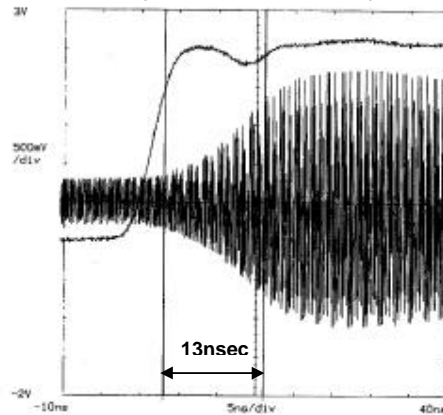

TYPICAL CHARACTERISTICS (Parts Table3)

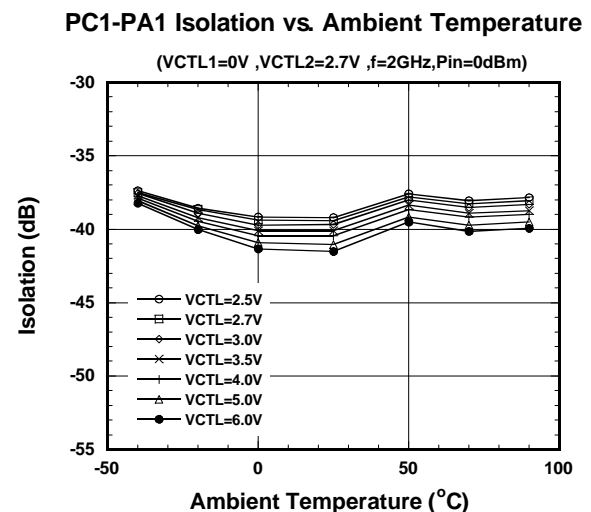
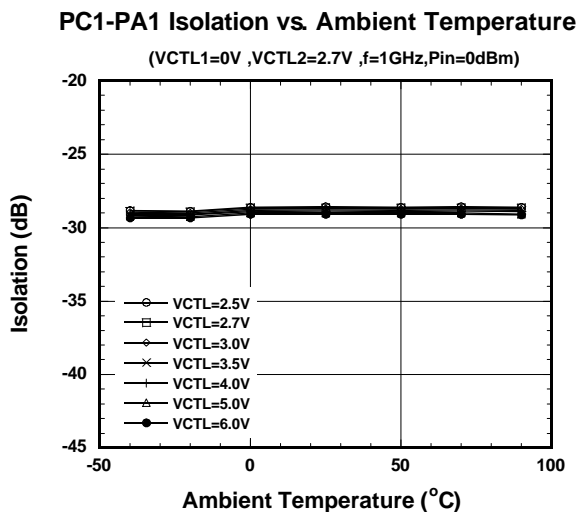
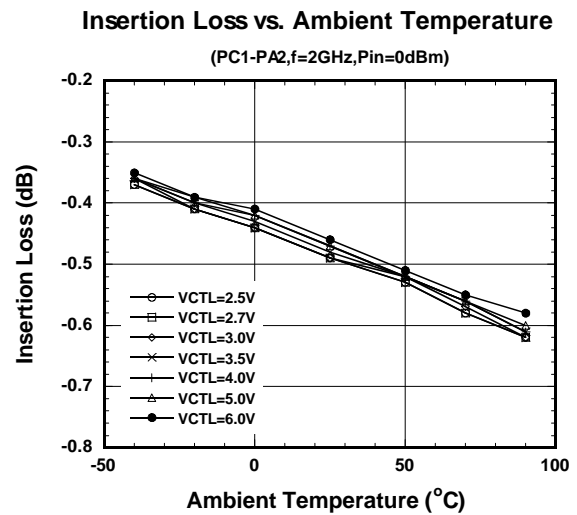
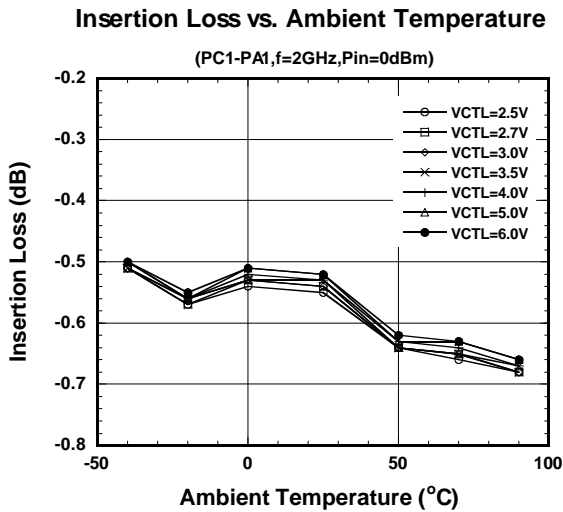
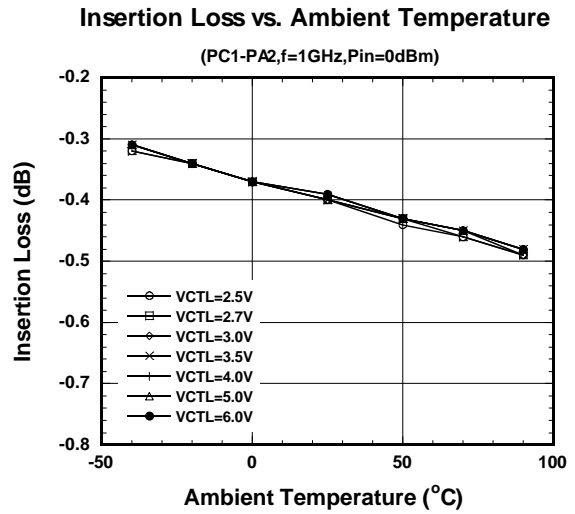
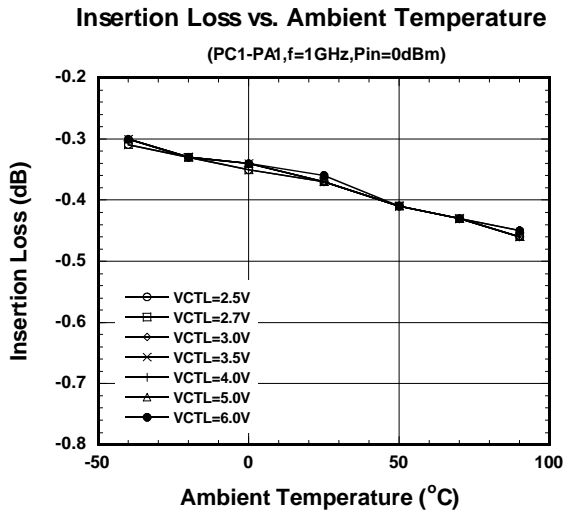

NJG1524PC1

TYPICAL CHARACTERISTICS (Parts Table3)

PC1-PA2 Isolation vs. Ambient Temperature

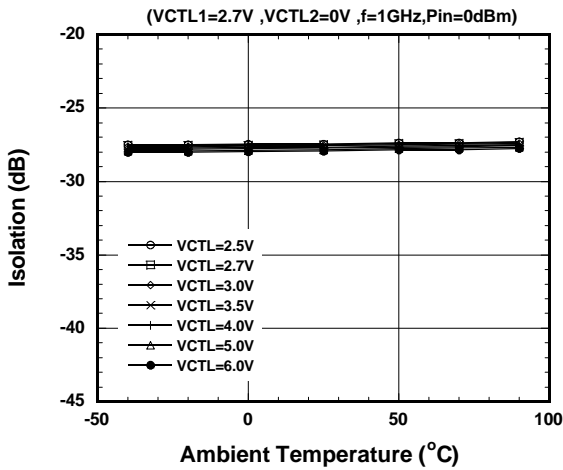

PC1-PA2 Isolation vs. Ambient Temperature

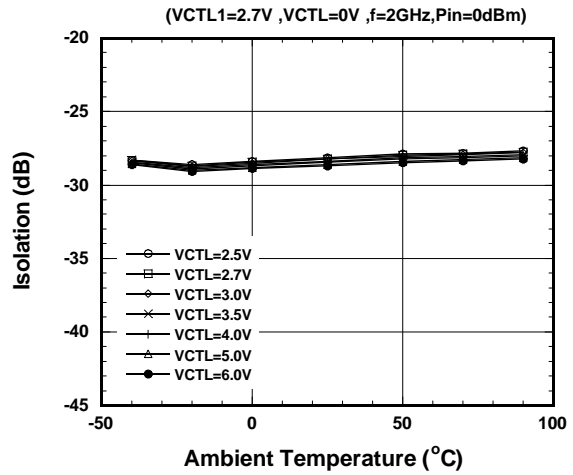

PA1-PA2 Isolation vs. Ambient Temperature

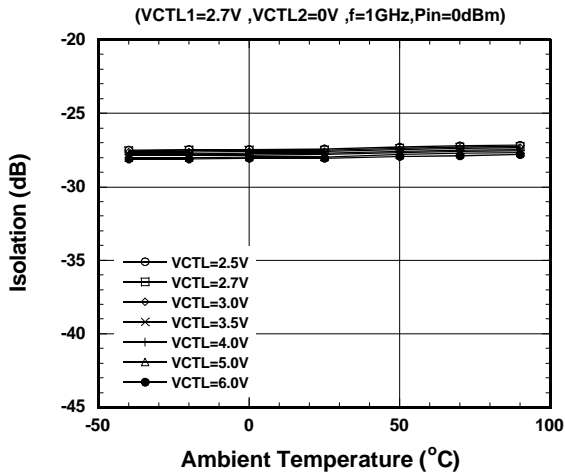

PA1-PA2 Isolation vs. Ambient Temperature

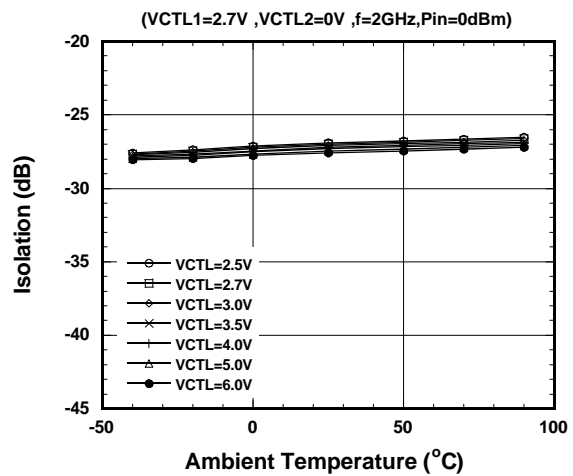

PC1-PC2 Isolation vs. Ambient Temperature

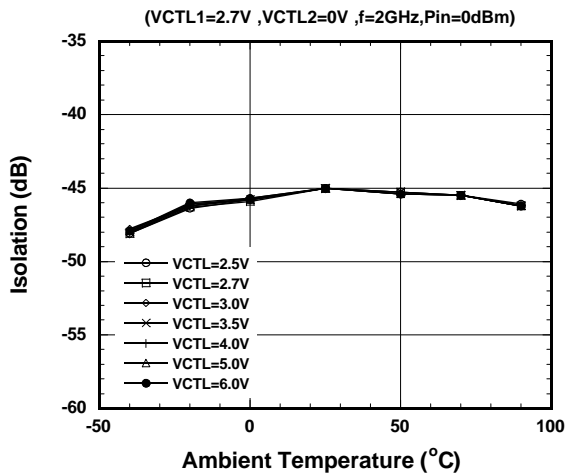

■ TYPICAL CHARACTERISTICS (Parts Table3)

PC1-PA1(on) VSWR vs. Ambient Temperature

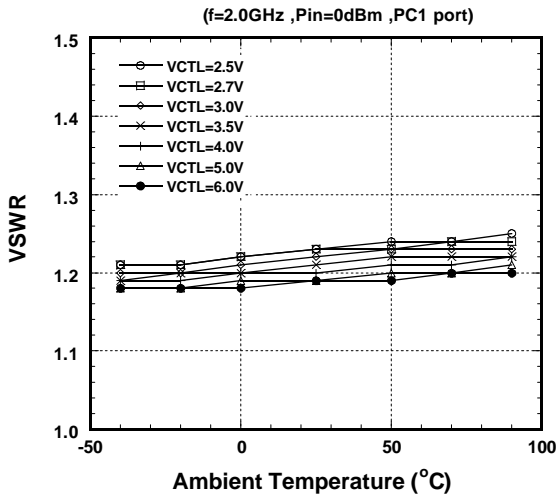

PC1-PA1(on) VSWR vs. Ambient Temperature

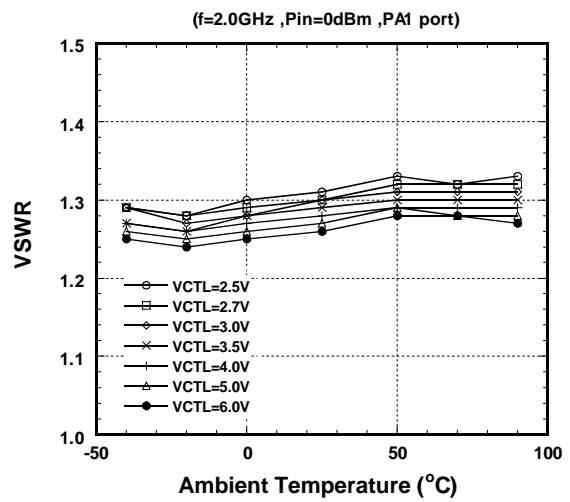

PC1-PA2(on) VSWR vs. Ambient Temperature

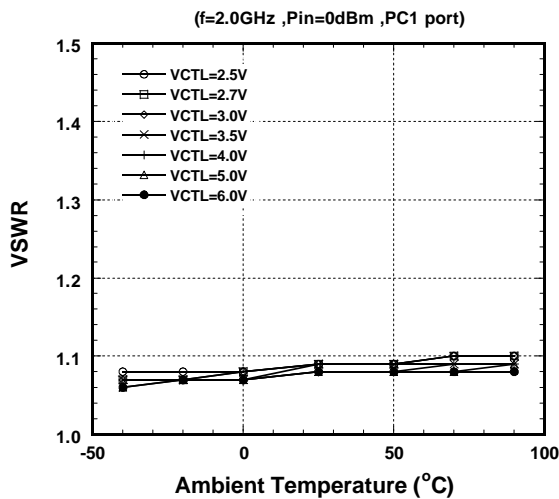

PC1-PA2(on) VSWR vs. Ambient Temperature

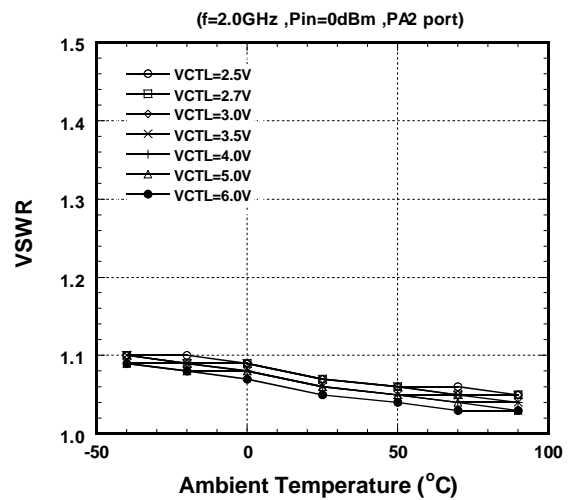

PC2-PB1(on) VSWR vs. Ambient Temperature

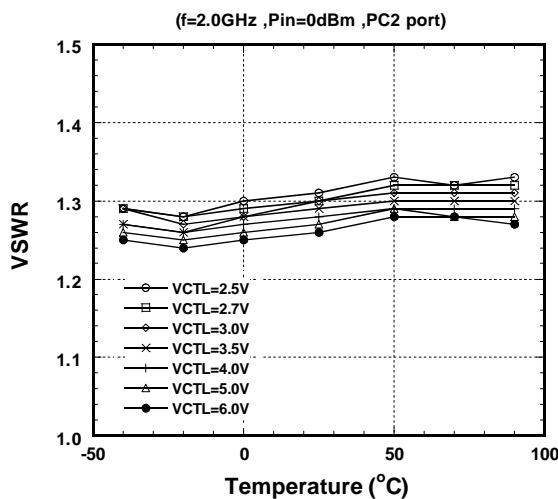

PC2-PB1(on) VSWR vs. Ambient Temperature

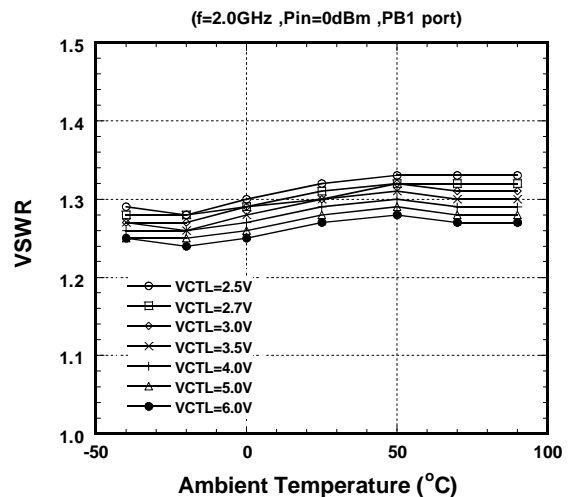

NJG1524PC1

TYPICAL CHARACTERISTICS (Parts Table3)

PC2-PB2(on) VSWR vs. Ambient Temperature

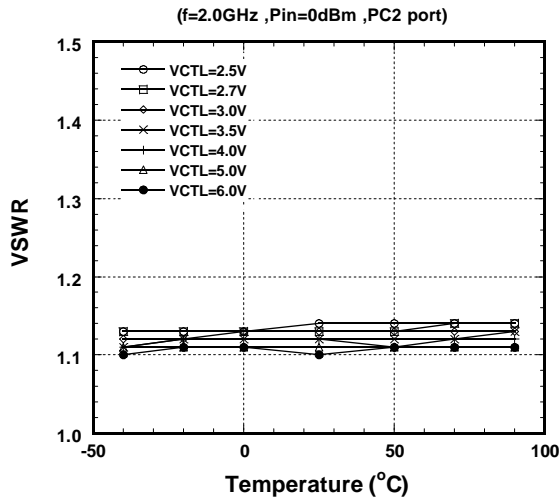

PC2-PB2(on) VSWR vs. Ambient Temperature

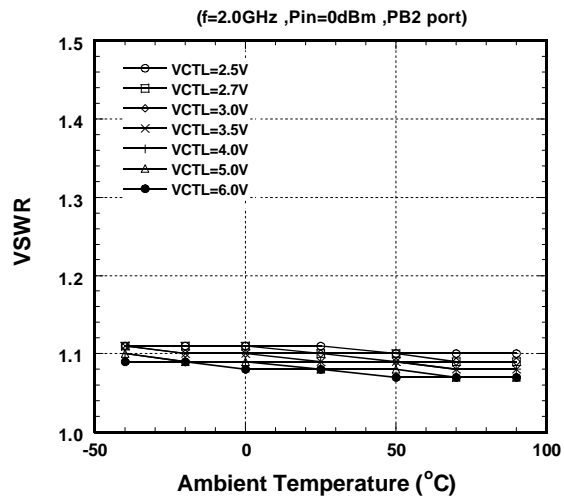

Control Current vs. Ambient Temperature

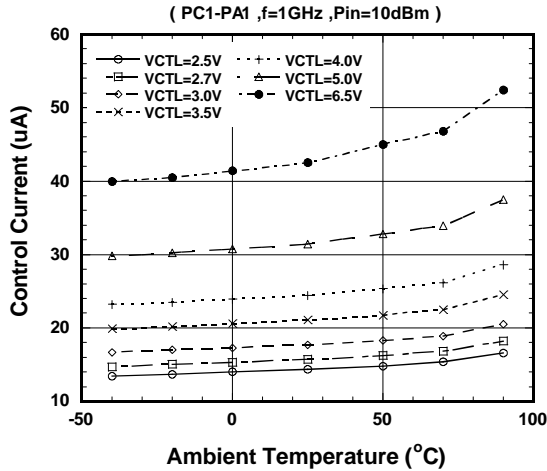

Control Current vs. Ambient Temperature

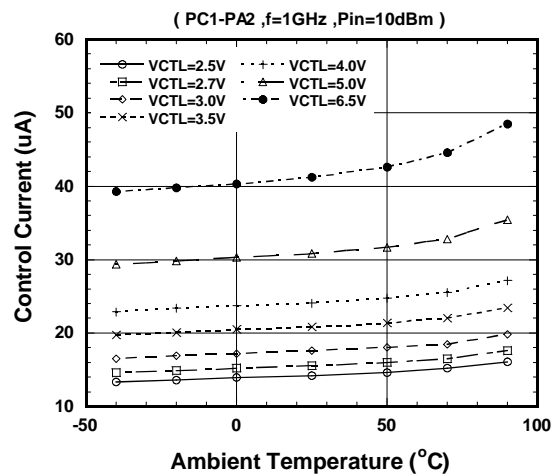

P-1dB vs. Ambient Temperature

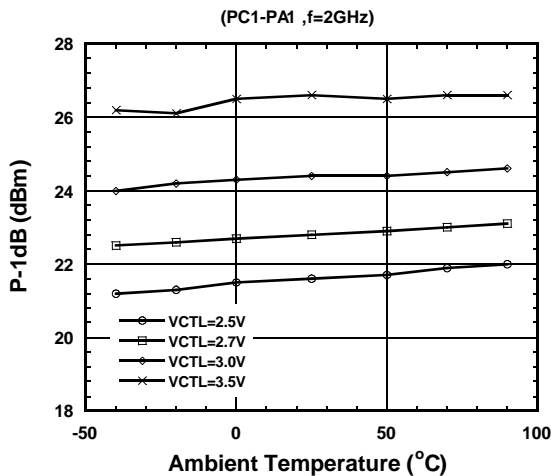

P-1dB vs. Ambient Temperature

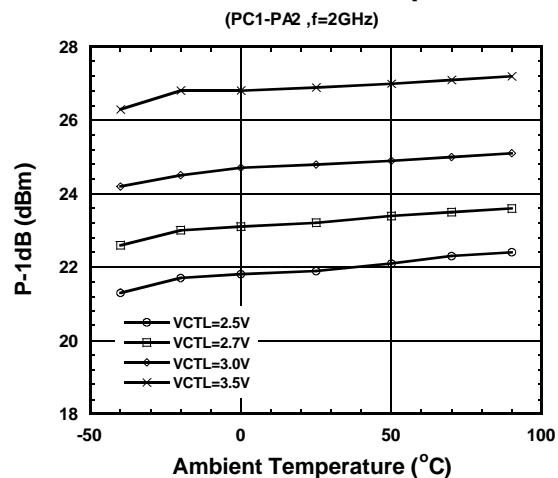

APPLICATION CIRCUIT

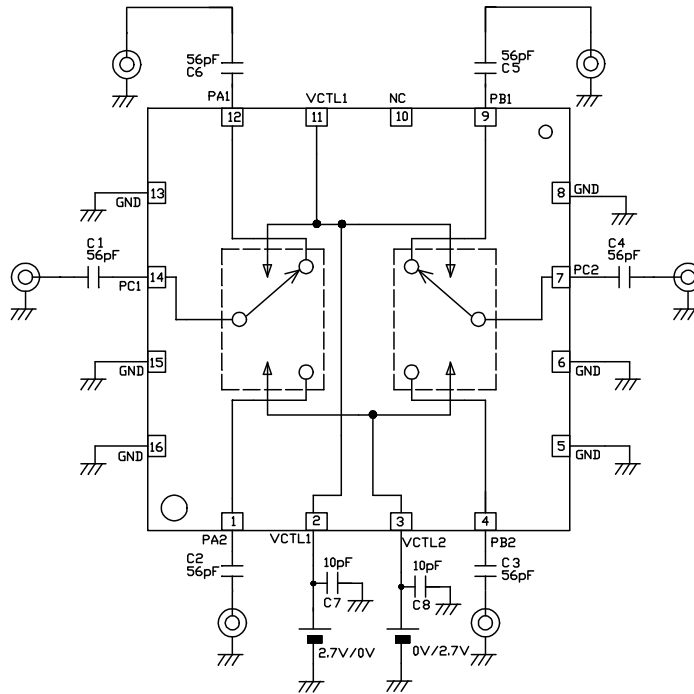

RECOMMENDED PCB DESIGN

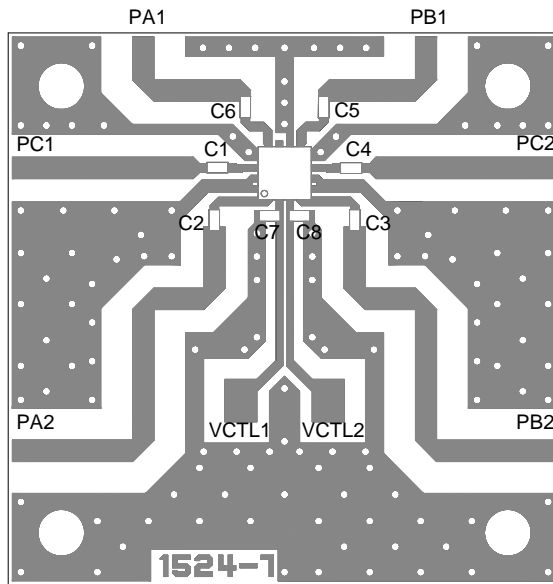

PCB SIZE=26x26mm
 PCB: FR-4, t=0.5mm
 CAPACITOR: size 1005
 Strip line width=1.0mm

Parts table

Parts ID	1	2	3
	fin=50-100MHz	fin=0.1-0.5GHz	fin=0.5-2.5GHz
C1-C6	0.01uF	1000pF	56pF
C7,C8	10pF	10pF	10pF

PRECAUTION

- [1]The DC blocking capacitor have to be placed at RF terminal of PC1, PC2, PA1, PA2, PB1, PB2. Please choose appropriate capacitance values to the application frequency.
- [2]To reduce stripline influence on RF characteristics, please locate bypass capacitors (C7, C8) close to each terminal.
- [3]For good isolation the GND terminal must be placed possibly close to ground place of substrate, and through holes for GND should be placed near by the pin connection.

NJG1524PC1

PACKAGE OUTLINE (FFP16-C1)

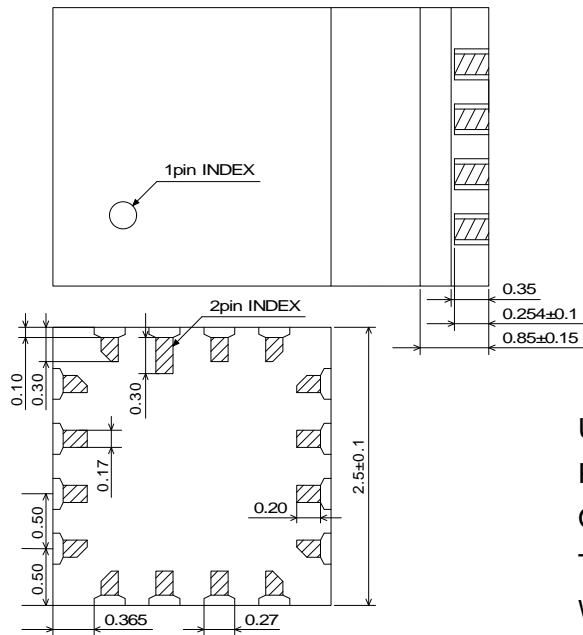

UNIT	: mm
PCB	: Ceramic
OVER COAT	: Epoxy resin
TERMINAL TREAT	: Au
WEIGHT	: 15mg

Cautions on using this product

This product contains Gallium-Arsenide (GaAs) which is a harmful material.

- Do NOT eat or put into mouth.
- Do NOT dispose in fire or break up this product.
- Do NOT chemically make gas or powder with this product.
- To waste this product, please obey the relating law of your country.

This product may be damaged with electric static discharge (ESD) or spike voltage. Please handle with care to avoid these damages.

[CAUTION]

The specifications on this databook are only given for information, without any guarantee as regards either mistakes or omissions. The application circuits in this databook are described only to show representative usages of the product and not intended for the guarantee or permission of any right including the industrial rights.