



MH205A

High Linearity Cellular-Band MMIC Mixer



Product Features

- +35 dBm Input IP3
- 7 dB Conversion Loss
- RF: 800 – 960 MHz
- LO: 700 – 890 MHz
- IF: 70 – 120 MHz
- +17 dBm Drive Level
- Lead-free / RoHS-compliant / Green SOIC-8 package
- No External Bias Required

Product Description

The MH205A is a passive GaAs MESFET mixer that provides high dynamic range performance in a low-cost lead-free/green/RoHS-compliant SOIC-8 package. WJ's MH205A uses patented techniques to realize +35 dBm Input IP3 at an LO drive level of +17 dBm and can be used for upconverting or downconverting low-side LO applications. This single monolithic integrated circuit does not require any external baluns or bias elements.

Typical applications include frequency up/down conversion, modulation and demodulation for receivers and transmitters used in 2.5G and 3G GSM/CDMA/wCDMA mobile infrastructure in the cellular frequency band.

Functional Diagram

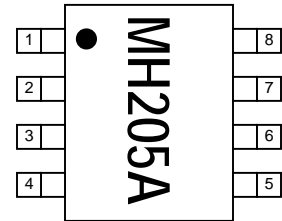

Function	Pin No.
LO	2
IF & RF*	7
GND	1, 3, 4, 6, 8
N/C or GND	5

* External components (inductors & capacitors) are required to diplex the signal

Applications

- 2.5G and 3G GSM/CDMA/wCDMA Mobile Infrastructure

Specifications

Parameters	Units	Min	Typ	Max	Comments
RF Frequency Range	MHz		800 – 960		
LO Frequency Range	MHz		700 – 890		
IF Frequency Range	MHz		70 – 120		
SSB Conversion Loss	dB		7	9.5	See note 1
Noise Figure	dB		7.5		See note 2
Input IP3	dBm	+28	+35		See notes 1 and 3
Input P1dB	dBm		+18		
LO – RF Isolation	dB	30	37		
LO – IF Isolation	dB	47	55		
RF – IF Isolation	dB		15		
Return Loss: RF Port	dB		15		See note 4
Return Loss: IF Port	dB		16		See note 4
Return Loss: LO Port	dB		11		
LO Drive Level	dBm		+17		

1. Test conditions unless otherwise noted: RF / IF = 803 / 70 and 963 / 70 with a low-side LO at +17 dBm in a downconverting application at 25 °C.

The diplexer shown on the application circuit is used in the test fixture.

2. Assumes LO injection noise is filtered at the thermal noise floor, -174 dBm/Hz, at the RF, IF, and Image frequencies.

3. IIP3 is measured with Af = 1 MHz with RFin = 0 dBm / tone.

4. The return loss is measured after the diplexer which splits the RF and IF signals from the mixer.

Absolute Maximum Rating

Parameter	Rating
Operating Case Temperature	-40 to +85 °C
Storage Temperature	-65 to +100 °C
LO Power	+21 dBm
Input IF / RF Power	+20 dBm

Operation of this device above any of these parameters may cause permanent damage.

Ordering Information

Part No.	Description
MH205A-G	High Dynamic Range Cellular-band MMIC Mixer (lead-free/green/RoHS-compliant SOIC-8 package)
MH205A-PCB	Fully-Assembled Mixer Application Board

Specifications and information are subject to change without notice



MH205A

High Linearity Cellular-Band MMIC Mixer



Typical Downconversion Performance Plots Performance using the circuitry on the MH205A-PCB Evaluation Board

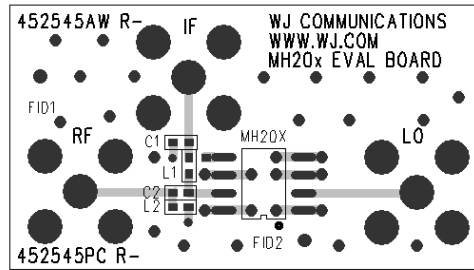
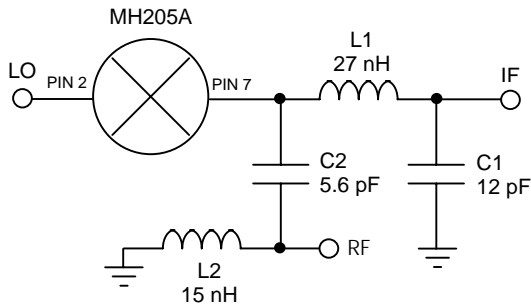

Circuit Board Material: .014" FR-4, 4 layers, .062" total thickness
 All passive components are 0402 size.
 All other pins on mixer are grounded.

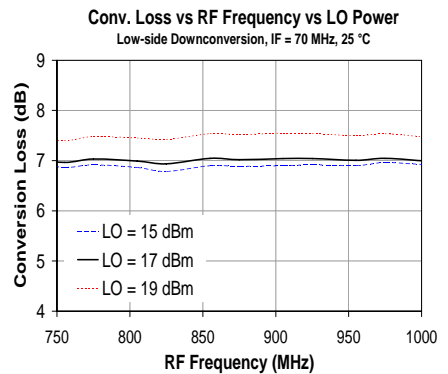
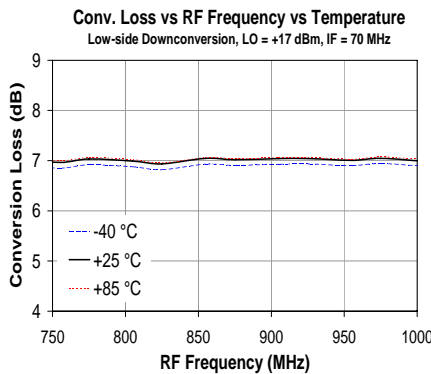
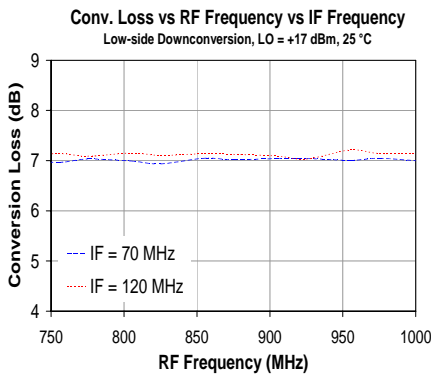
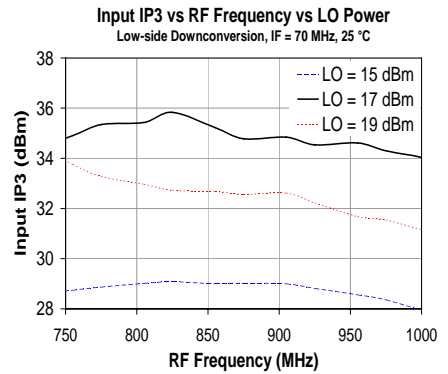
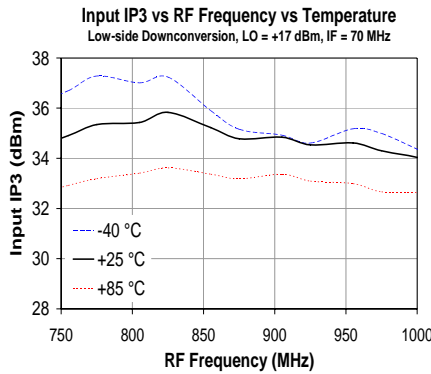
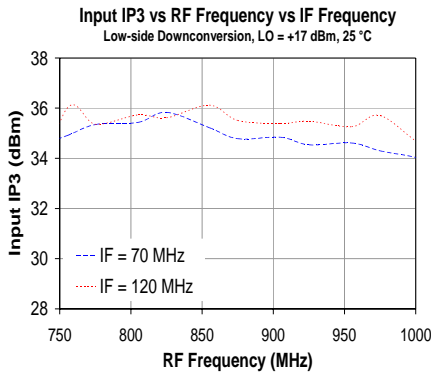

Specifications and information are subject to change without notice



MH205A

High Linearity Cellular-Band MMIC Mixer



Typical Downconversion Performance Plots (cont'd) Performance using the circuitry on the MH205A-PCB Evaluation Board

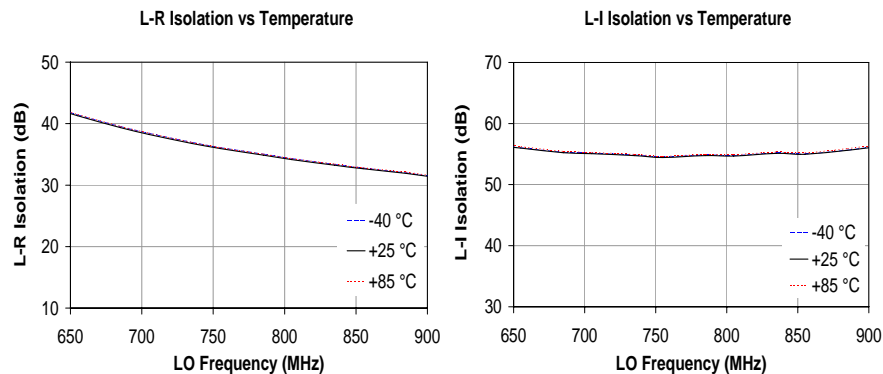
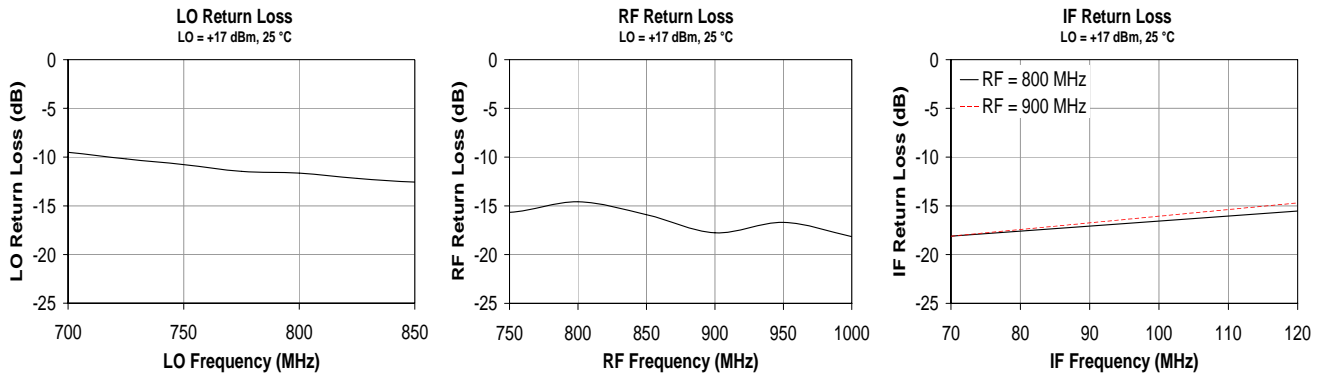

Intermodulation (IMD) Product Table Performance using the circuitry on the MH205A-PCB Evaluation Board

		Harmonics of f_{LO}					
		0	1	2	3	4	5
Harmonics of f_{RF}	0	--	57	76	89	79	85
	1	18	0	42	63	59	64
	2	90	75	43	63	84	83
	3	>93	>93	89	64	77	>93
	4	>93	>93	>93	>93	80	85
	5	>93	>93	>93	>93	>93	88

RF frequency = 940 MHz @ 0 dBm

LO Frequency = 870 MHz @ +17 dBm

IM product amplitude is in dBc relative to IF output amplitude.

The harmonics of f_{LO} with $0 \cdot f_{RF}$ are relative to the LO input signal (17 dBm).



MH205A-G Mechanical Information

This package is lead-free/green/RoHS-compliant. The plating material on the leads is NiPdAu. It is compatible with both lead-free (maximum 260 °C reflow temperature) and lead (maximum 245 °C reflow temperature) soldering processes.

Outline Drawing

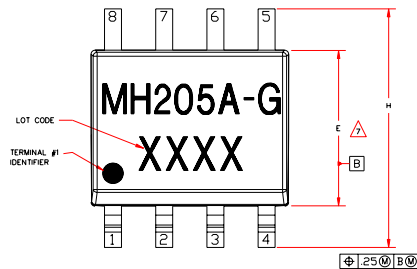

- NOTES:
- EXCEPT WHERE NOTED, THIS PART OUTLINE CONFORMS TO JEDEC STANDARD MS-012, ISSUE C FOR SMALL OUTLINE (SMD) PERIPHERAL TERMINALS 3.75mm BODY WIDTH (PLASTIC).
 - DIMENSIONING & TOLERANCING CONFORM TO ASME Y14.5M-1994.
 - ALL DIMENSIONS ARE IN MILLIMETERS. ANGLES ARE IN DEGREES.
 - DOES NOT INCLUDE MOLD FLASH, PROTRUSIONS OR GATE BURRS, WHICH SHALL NOT EXCEED .15mm(.006in) PER SIDE.
 - DEVIATION FROM JEDEC MS-012 STANDARD.
 - LENGTH OF TERMINAL FOR SOLDERING TO A SUBSTRATE.
 - DOES NOT INCLUDE INTER-LEAD FLASH OR PROTRUSIONS, WHICH SHALL NOT EXCEED .25mm(.010in) PER SIDE.

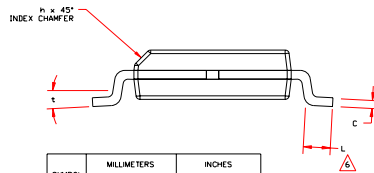
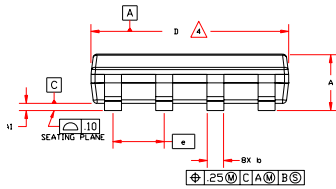

SYMBOL	MILLIMETERS		INCHES	
	MIN.	MAX.	MIN.	MAX.
A	1.30	1.40	.051	.055
A1	.10	.25	.004	.010
b	.41		.016	
C	.20		.008	
D	4.80	5.00	.189	.197
E	3.80	4.00	.150	.157
e	1.27 BSC		.050 BSC	
H	5.80	6.20	.228	.244
h	.25	.50	.01	.02
L	.40	1.27	.016	.050
t	0	8"	0	8"

Product Marking

The component will be marked with an "MH205A-G" designator with an alphanumeric lot code on the top surface of the package. The obsolete tin-lead package is marked with an "M205A" designator with an alpha numeric lot code.

Tape and reel specifications for this part are located on the website in the "Application Notes" section.

ESD / MSL Information



Caution! ESD sensitive device.

ESD Rating: Class 1B

Value: Passes /500V to <1000 V

Test: Human Body Model (HBM)

Standard: JEDEC Standard JESD22-A114

ESD Rating: Class III

Value: Passes /500 V to <1000 V

Test: Charged Device Model (CDM)

Standard: JEDEC Standard JESD22-C101

MSL Rating: Level 2 at +260 °C convection reflow

Standard: JEDEC Standard J-STD-020

Land Pattern / Mounting Configuration

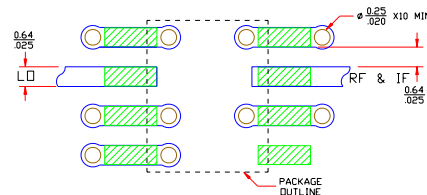
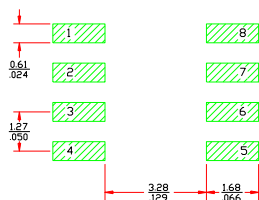

- Notes: 1. Ground vias are critical for RF grounding considerations.
2. A minimum of 10 ground vias are required for 14 mil and 28 mil FR4 board.
3. Trace width depends on PC board.

Functional Pin Layout

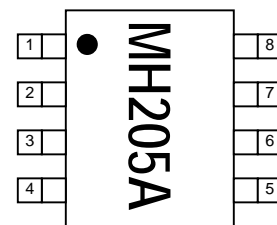

Pin	Function
1	Ground
2	LO Port
3	Ground
4	Ground
5	No Connect / Ground
6	Ground
7	RF / IF Port*
8	Ground

* External components (inductors & capacitors) are required to diplex the signal