

**Low Noise GaAs MMIC Amplifier
1.2 - 1.75 GHz**

**MAAM12000-A1
V4**

Features

- Low Noise Figure: 1.35 dB
- High Gain: 26 dB
- No External Components Required
- DC Decoupled RF Input and Output
- Lead-Free 8-Lead Ceramic Package
- RoHS* Compliant and 260°C Reflow Compatible

Description

M/A-COM's MAAM12000-A1 is a wide band, low noise, MMIC amplifier housed in a lead-free, small 8-lead ceramic package. It includes two integrated gain stages and employs series inductive feedback to obtain excellent noise figure and a good, 50-ohm, input and output impedance match over the 1.2 to 1.75 GHz band. The MAAM12000-A1 is fully monolithic, requires no external components and is provided in a low-cost, user-friendly, microwave package.

The MAAM12000-A1 is ideally suited to receivers in GPS and DGPS applications and operates over both the L1 and L2 frequency bands. Because of its wide bandwidth, the MAAM12000-A1 can also be used as a driver, buffer or IF amplifier in numerous commercial and government system applications that require high gain, excellent linearity and low power consumption.

The MAAM12000-A1 is manufactured in-house using a reliable, 0.5 micron, GaAs MESFET process. This product is 100% RF tested to ensure compliance to performance specifications.

Ordering Information

Part Number	Package
MAAM12000-A1	8-Lead Ceramic
MAAM12000-A1G	Gull Wing

Schematic

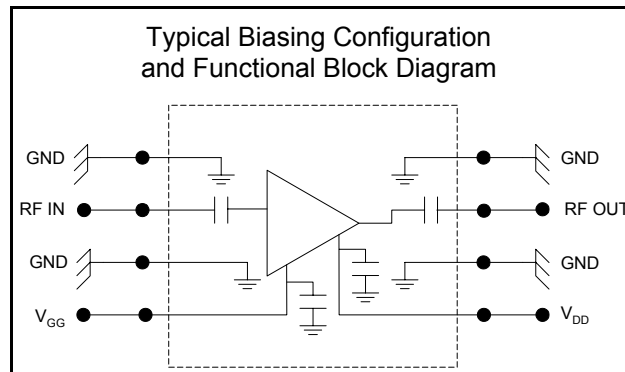

Pin Configuration¹

Pin No.	Function	Pin No.	Function
1	Ground	5	V _{DD}
2	RF Input	6	Ground
3	Ground	7	RF Output
4	V _{GG}	8	Ground

1. The package bottom must be connected to RF and DC ground.

Absolute Maximum Ratings^{2,3}

Parameter	Absolute Maximum
V _{DD}	+7 V
V _{GG}	-10 V
Input Power	+20 dBm
Current	150 mA
Channel Temperature	+150°C
Operating Temperature ⁴	-55°C to +100°C
Storage Temperature	-65°C to +150°C

- Exceeding any one or combination of these limits may cause permanent damage to this device.
- M/A-COM does not recommend sustained operation near these survivability limits.
- Typical thermal resistance (θ_{jc}) = +110°C/W.

* Restrictions on Hazardous Substances, European Union Directive 2002/95/EC.

**Low Noise GaAs MMIC Amplifier
1.2 - 1.75 GHz**

**MAAM12000-A1
V4**

Electrical Specifications: $T_A = 25^\circ\text{C}$, $V_{DD} = +5\text{ V}$, $V_{GG} = -5\text{ V}$, $Z_0 = 50\ \Omega$

Parameter	Test Conditions	Units	Min.	Typ.	Max.
Gain	1.20 - 1.75 GHz, $P_{IN} = -30\text{ dBm}$	dB	23	26	—
Noise Figure	1.20 - 1.75 GHz, $P_{IN} = -30\text{ dBm}$	dB	—	1.35	1.8
Input VSWR	1.20 - 1.75 GHz, $P_{IN} = -30\text{ dBm}$	Ratio	—	1.4:1	—
Output VSWR	1.20 - 1.75 GHz, $P_{IN} = -30\text{ dBm}$	Ratio	—	1.4:1	—
Output 1 dB Compression	1.20 - 1.75 GHz	dBm	—	+14	—
Input IP3	1.20 - 1.75 GHz, $P_{IN} = -30\text{ dBm}$	dBm	—	-2	—
Reverse Isolation	1.20 - 1.75 GHz, $P_{IN} = -30\text{ dBm}$	dB	—	35	—
Bias Current	—	mA	—	80	110

Handling Procedures

Please observe the following precautions to avoid damage:

Static Sensitivity

Gallium Arsenide Integrated Circuits are sensitive to electrostatic discharge (ESD) and can be damaged by static electricity. Proper ESD control techniques should be used when handling these devices.

Operating The MAAM12000-A1

Nominal bias is obtained by connecting -5 volts to pin 4 (V_{GG}) followed by connecting +5 volts to pin 5 (V_{DD}). Note sequence.

Power down in reverse sequence.

Lead-Free CR-3 (MAAM12000-A1)[†]

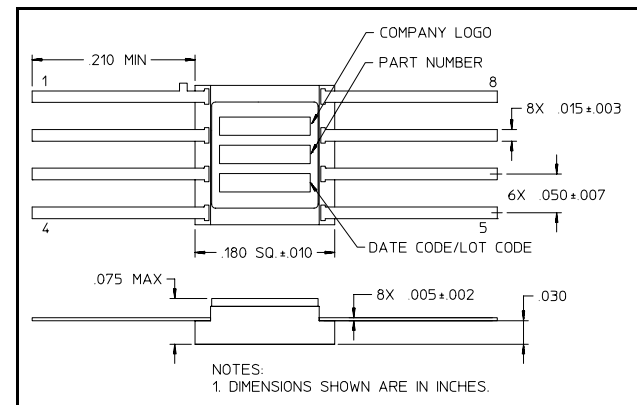

Lead-Free CR-10 (MAAM12000-A1G)[†]

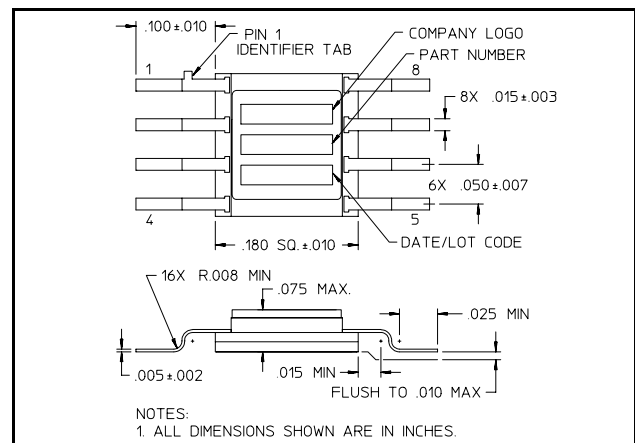

[†] Reference Application Note M538 for lead-free solder reflow recommendations.

**Low Noise GaAs MMIC Amplifier
1.2 - 1.75 GHz**

**MAAM12000-A1
V4**

Typical Performance Curves

Gain

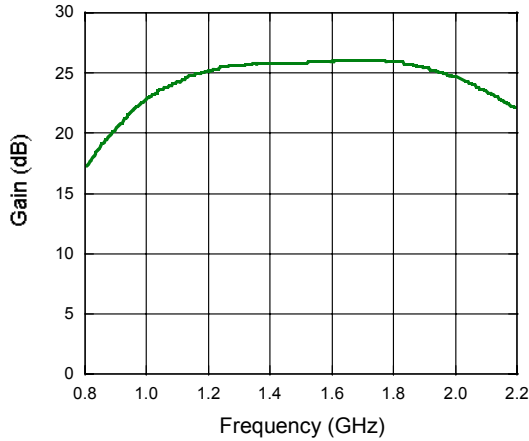

VSWR

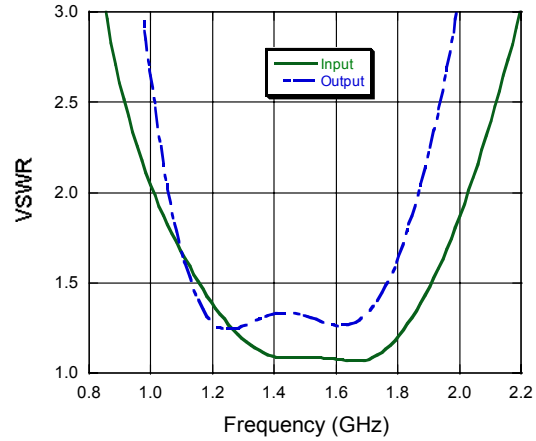

Noise Figure

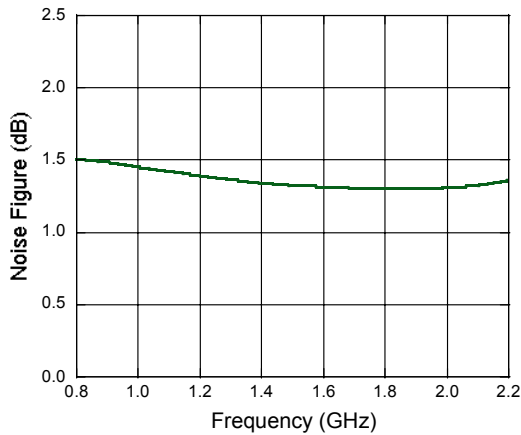

Reverse Isolation

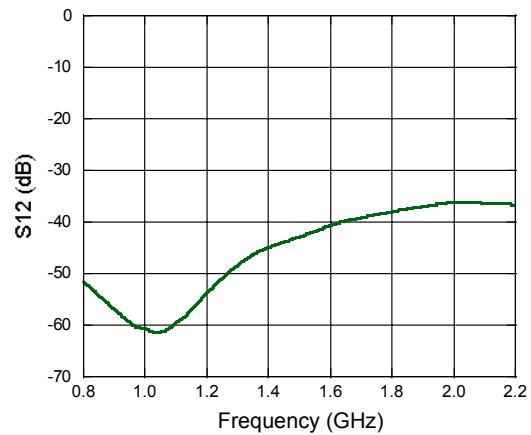

Output Power

