

**RF Driver Amplifier
250 - 4000 MHz**

**MAAMSS0049
V1**

Features

- Output Intercept Point of +40 dBm over a 20 dB Input Power Range
- Broadband Operation
- Excellent ACPR performance
- Lead-Free SOT-89 Package
- 100% Matte Tin Plating over Copper
- Halogen-Free "Green" Mold Compound
- RoHS* Compliant and 260°C Reflow Compatible

Description

M/A-COM's MAAMSS0049 RF driver amplifier is a GaAs MMIC which exhibits exceptional linearity performance over a >20 dB dynamic range, as well as featuring high gain in a lead-free miniature SOT-89 surface mount plastic package. The device runs off a single +5 volt supply and draws 230 mA typically.

The MAAMSS0049 is fabricated using an HBT process to realize low current and high linearity. The process features full passivation for increased performance and reliability.

Functional Schematic

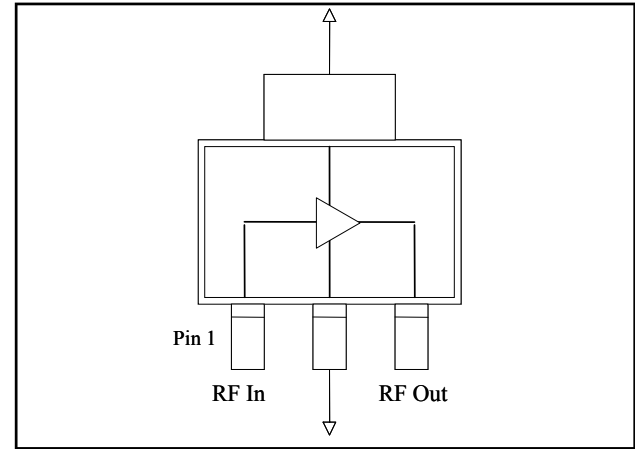

Pin Configuration

Pin No.	Function	Pin No.	Function
1	RF Input	3	RF Output/ Bias
2	Ground		

Ordering Information ¹

Part Number	Package
MAAMSS0049	Bulk Packaging
MAAMSS0049SMB-01	900 MHz Configuration
MAAMSS0049SMB-02	1900 MHz Configuration
MAAMSS0049SMB-03	2140 MHz Configuration
MAAMSS0049TR-3000	3000 piece reel

1. Reference Application Note M513 for reel size information.

Maximum Operating Conditions ²

Parameter	Maximum Operating Conditions
Junction Temperature	160°C
RF Output Power	28 dBm

2. Operating at, or below this condition, at or below 85°C will give a MTTF > 1 x 10⁶ hours.

Absolute Maximum Ratings ^{3,4}

Parameter	Absolute Maximum
RF Output Power	29 dBm
Voltage	6 volts
Operating Temperature	-40 °C to +85 °C
Storage Temperature	-65 °C to +150 °C
Junction Temperature ⁵	200°C

3. Exceeding any one or combination of these limits may cause permanent damage to this device.
4. M/A-COM does not recommend sustained operation near these survivability limits.
5. Typical thermal resistance (θ_{jc}) = 55°C/W.

* Restrictions on Hazardous Substances, European Union Directive 2002/95/EC.

**RF Driver Amplifier
250 - 4000 MHz**

**MAAMSS0049
V1**

Electrical Specifications: $T_A = 25^\circ\text{C}$, $V_{CC} = 5\text{ V}$, $Z_0 = 50\ \Omega$

Parameter	Test Conditions	Units	Min.	Typ.	Max.
Gain	900 MHz	dB	—	19.0	—
	1900 MHz	dB	—	15.5	—
	2140 MHz	dB	14	15.5	—
Input Return Loss	900 MHz	dB	—	-15	—
	1900 MHz	dB	—	-11	—
	2140 MHz	dB	—	-20	—
Output Return Loss	900 MHz	dB	—	-15	—
	1900 MHz	dB	—	-10	—
	2140 MHz	dB	—	-15	—
Output P1dB	900 MHz	dBm	—	28.5	—
	1900 MHz	dBm	—	28.5	—
	2140 MHz	dBm	—	28.5	—
Output IP3	(+20 dBm / tone, 1 MHz spacing) 900 MHz	dBm	—	43	—
	1900 MHz	dBm	—	43	—
	2140 MHz	dBm	38	43	—
Channel Power	(@ -45 dBc ACPR, IS-95 9 channels fwd) 900 MHz	dBm	—	22	—
	1900 MHz	dBm	—	20	—
	2140 MHz	dBm	—	19	—
Noise Figure	900 MHz	dB	—	3.5	—
	1900 MHz	dB	—	3.5	—
	2140 MHz	dB	—	3.5	—
Device / Supply Voltage	900 MHz	V	—	5	—
	1900 MHz	V	—	5	—
	2140 MHz	V	—	5	—
Quiescent Current		mA	—	230	—
Current @ 20 dBm Output	2140 MHz	mA	—	288	325

Lead-Free SOT-89 Plastic Package[†]

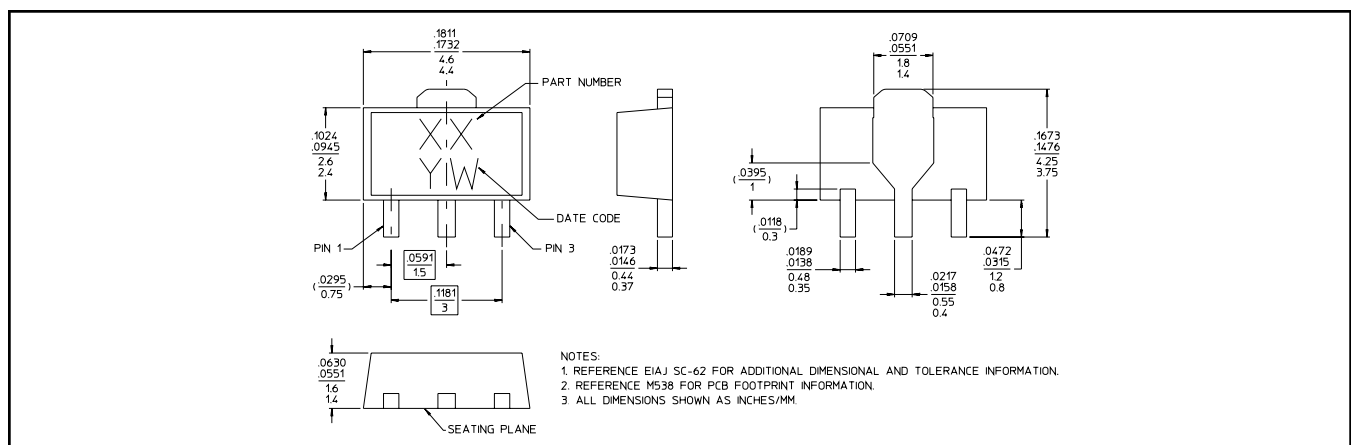

[†] Reference Application Note M538 for lead-free solder reflow recommendations.

M/A-COM Inc. and its affiliates reserve the right to make changes to the product(s) or information contained herein without notice. M/A-COM makes no warranty, representation or guarantee regarding the suitability of its products for any particular purpose, nor does M/A-COM assume any liability whatsoever arising out of the use or application of any product(s) or information.

- **North America** Tel: 800.366.2266 / Fax: 978.366.2266
- **Europe** Tel: 44.1908.574.200 / Fax: 44.1908.574.300
- **Asia/Pacific** Tel: 81.44.844.8296 / Fax: 81.44.844.8298

Visit www.macom.com for additional data sheets and product information.

**RF Driver Amplifier
250 - 4000 MHz**

**MAAMSS0049
V1**

900 MHz PCB Layout

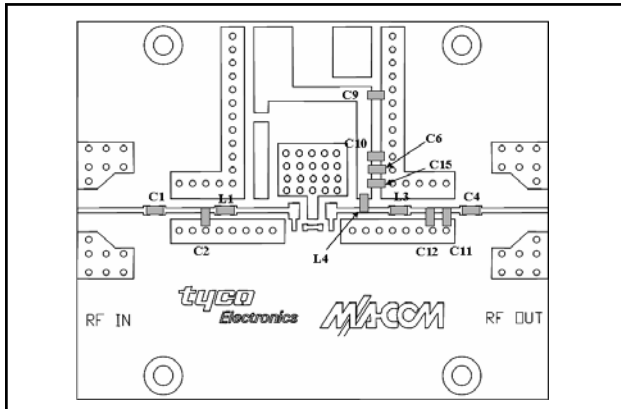

900 MHz Schematic

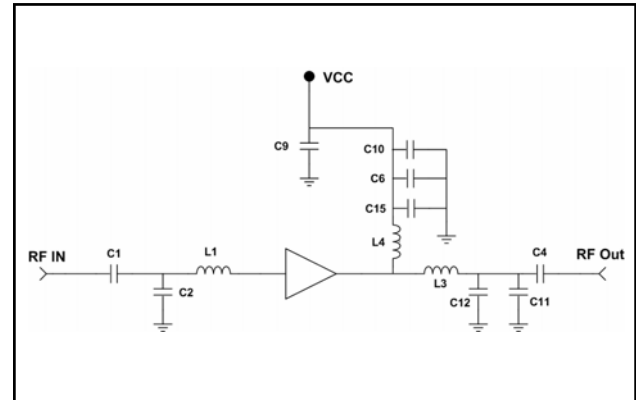

1900 MHz PCB Layout

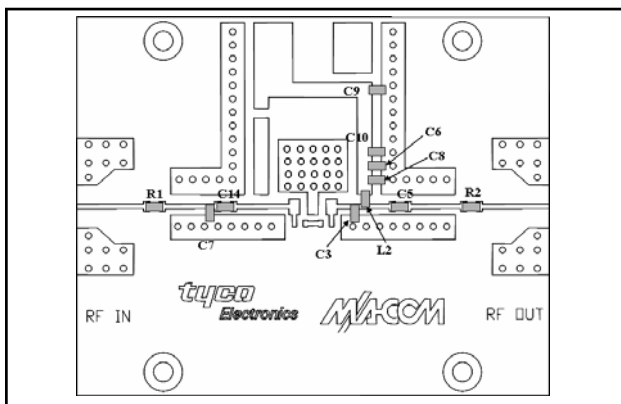

1900 MHz Schematic

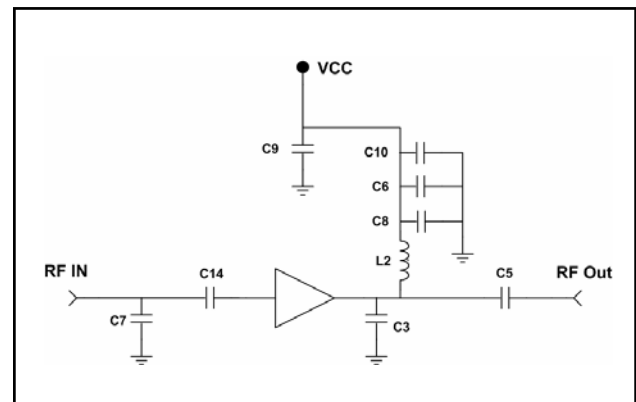

2140 MHz PCB Layout

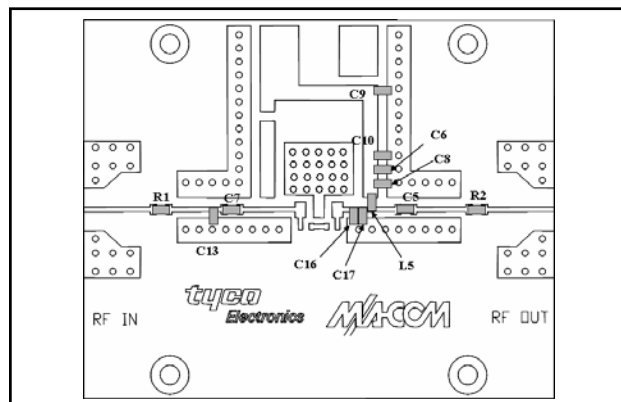

2140 Schematic

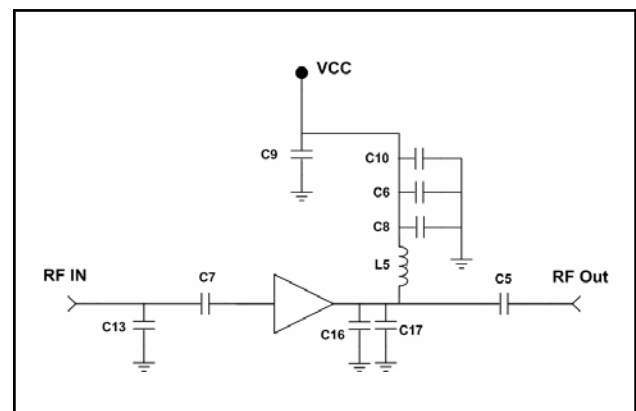

Parts List

Part	Value	Used on Freq. Band	Case Style	Manufacturer	Purpose
C1, C4	1000 pF	300, 900	0402	Murata	DC Block
C6	1000 pF	All	0402	Murata	Bypass
C2	6.8 pF	900	0402	Murata	Input Tuning
C3	3.3 pF	1900	0402	Murata	Output Tuning
C5	39 pF	1900, 2140	0402	Murata	DC Block
C7	2.7 pF	1900, 2140	0402	Murata	Input Tuning & DC Block
C8	15 pF	300, 1900, 2140, 2400, 3500	0402	Murata	Bypass
C9, C10	0.1 uF	All	0402	Murata	Bypass
C11	4.7 pF	900	0402	Murata	Output Tuning
C12	1.2 pF	900	0402	Murata	Output Tuning
C13	2.2 pF	1900	0402	Murata	Input Tuning
C16, C21	2.2 pF	2140, 2400	0402	Murata	Output Tuning
C14	5 pF	1900	0402	Murata	Output Tuning & DC Block
C15	100 pF	900	0402	Murata	Bypass
C17, C20, C23	1 pF	2140, 2400, 3500	0402	Murata	Input Tuning & Output Tuning
L1, L8	2.2 nH	900, 2400	0402	Coilcraft	Input Tuning
L2	5.6 nH	1900	0402	Coilcraft	Bias Injection
L3	1 nH	900	0402	Coilcraft	Output Tuning
L4	15 nH	900	0402	Coilcraft	Bias Injection
L5	3.6 nH	2140	0402	Coilcraft	Bias Injection
R1, R2	0 Ohms	1900, 2140	0402	Panasonic	Jumper
C18, C19	18 pF	300	0402	Murata	Input Tuning & Output Tuning
C22	0.5 pF	2400, 3500	0402	Murata	Input Tuning & Output Tuning
L6	23 nH	300	0402	Panasonic	Input Tuning
L7	8.2 nH	300	0402	Coilcraft	Output Tuning

Cross Section View

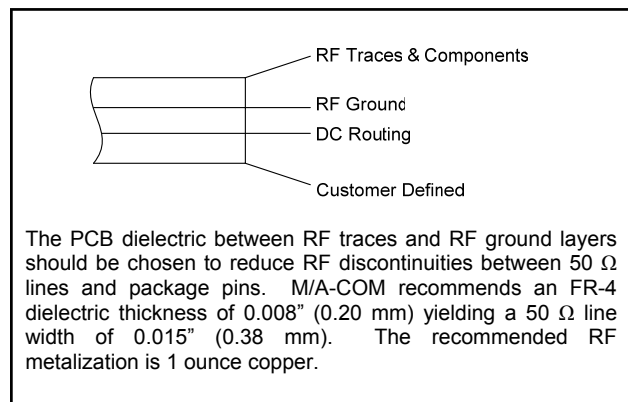

Handling Procedures

Please observe the following precautions to avoid damage:

Static Sensitivity

Gallium Arsenide Integrated Circuits are sensitive to electrostatic discharge (ESD) and can be damaged by static electricity. Proper ESD control techniques should be used when handling these devices.

- **North America** Tel: 800.366.2266 / Fax: 978.366.2266
- **Europe** Tel: 44.1908.574.200 / Fax: 44.1908.574.300
- **Asia/Pacific** Tel: 81.44.844.8296 / Fax: 81.44.844.8298

Visit www.macom.com for additional data sheets and product information.

Typical Performance Curves, 900 MHz Configuration, $V_{CC} = +5 V$

Gain

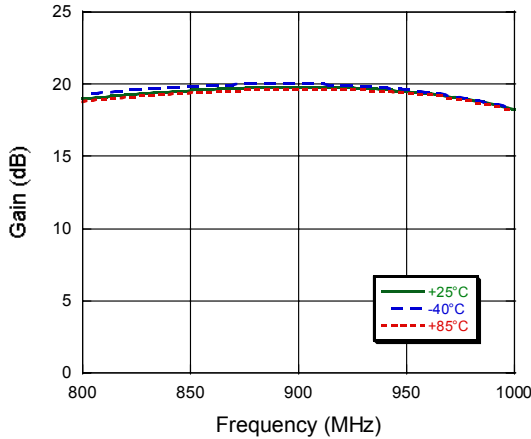

Noise Figure

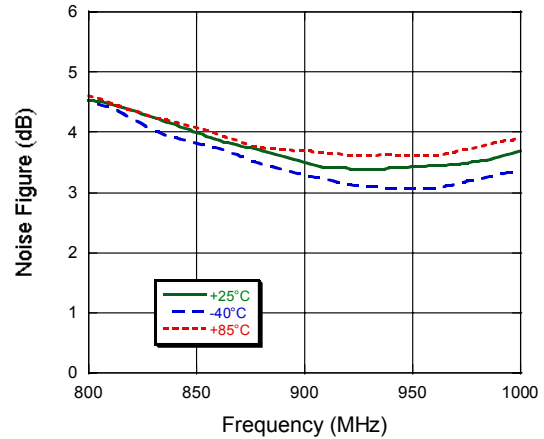

Input Return Loss

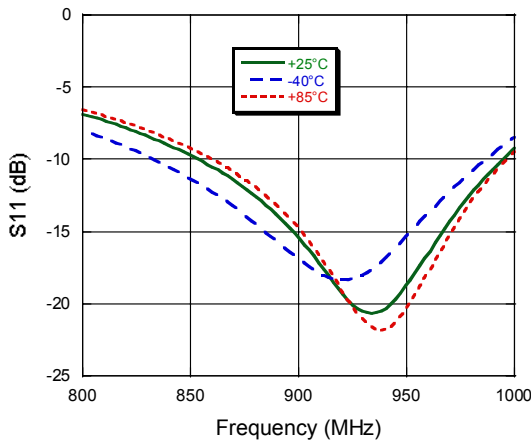

Output Return Loss

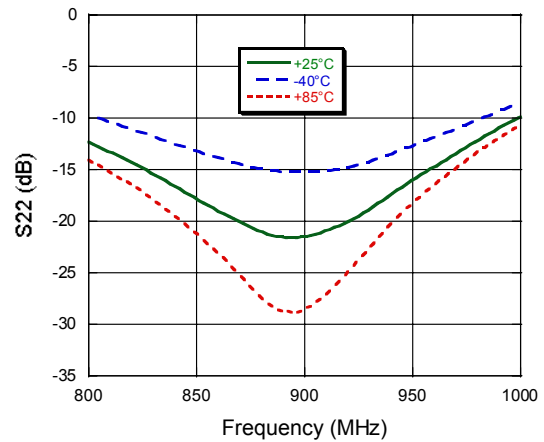

P1dB

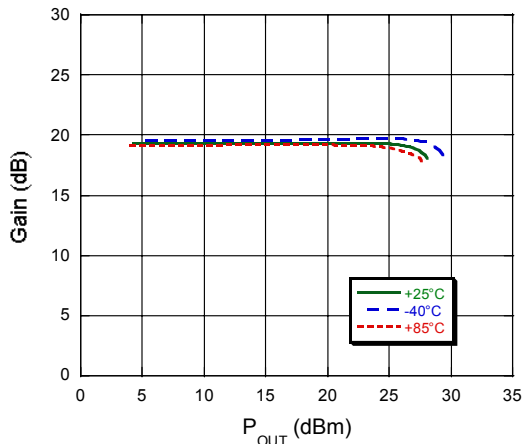

Output IP3

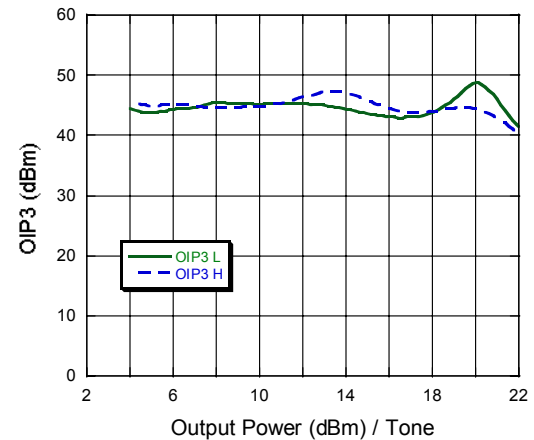

Typical Performance Curves, 1900 MHz Configuration

Gain

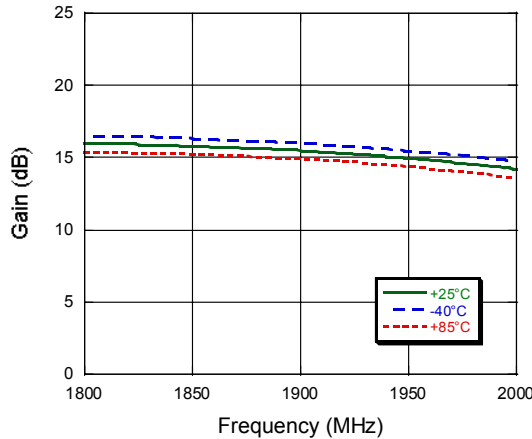

Noise Figure

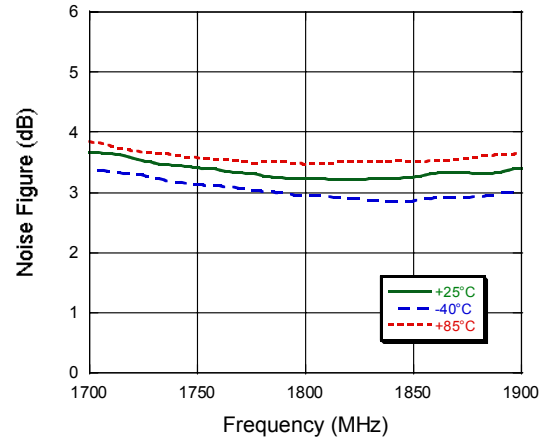

Input Return Loss

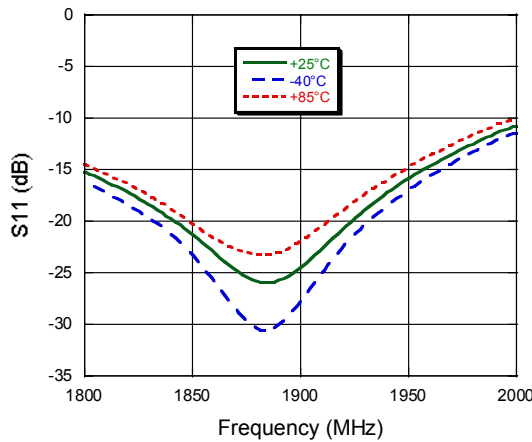

Output Return Loss

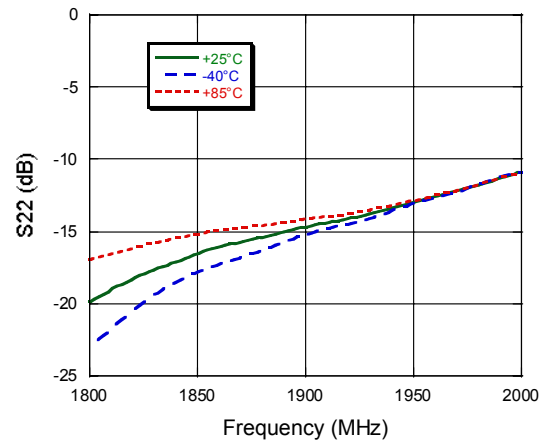

P1dB

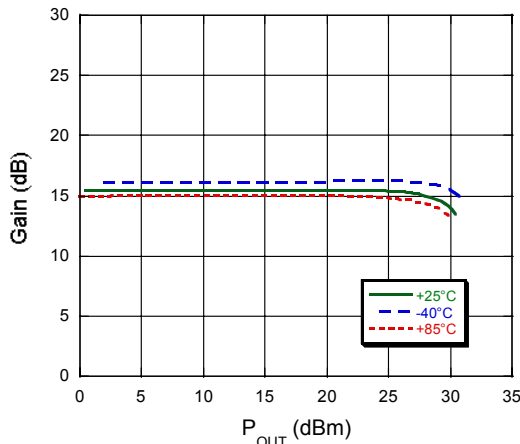

Output IP3

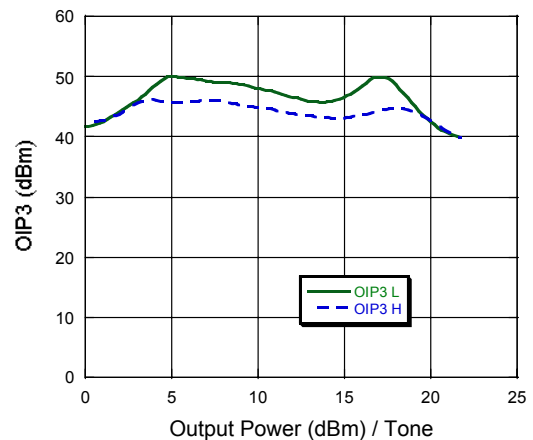

Typical Performance Curves, 2140 MHz Configuration

Gain

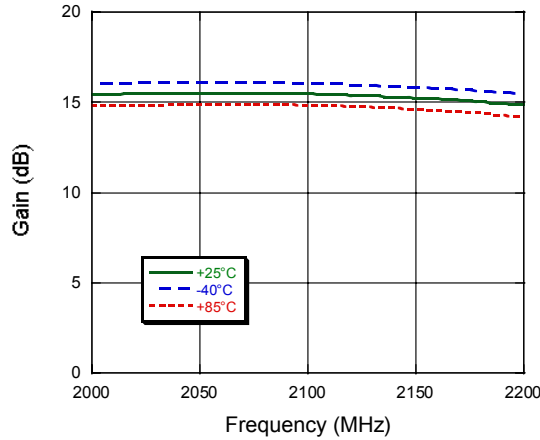

Noise Figure

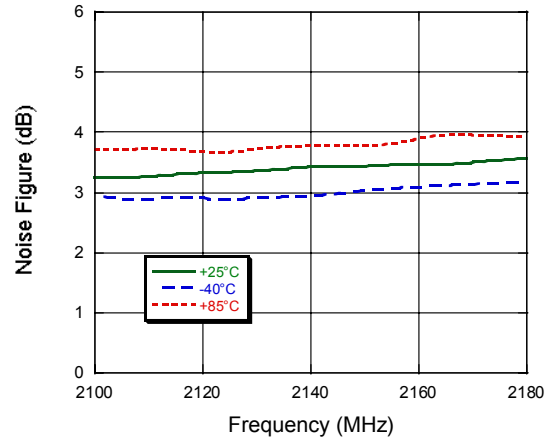

Input Return Loss

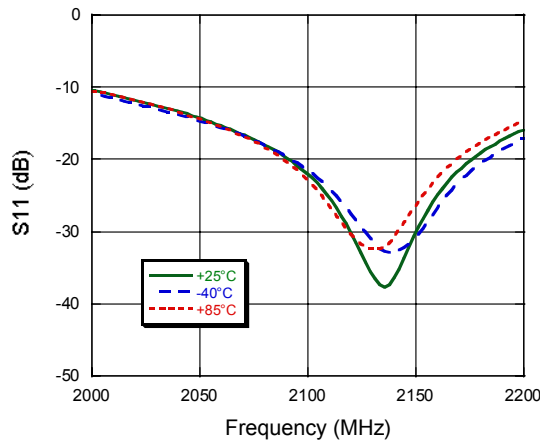

Output Return Loss

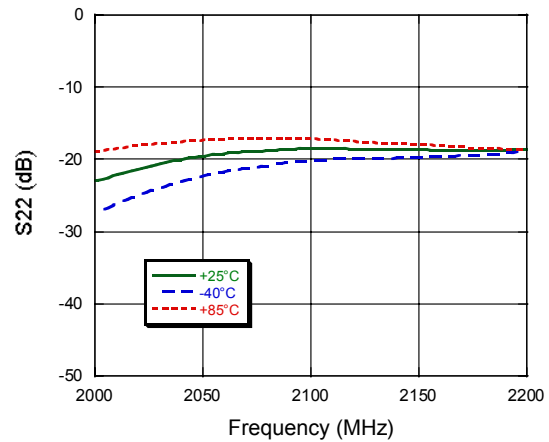

P1dB

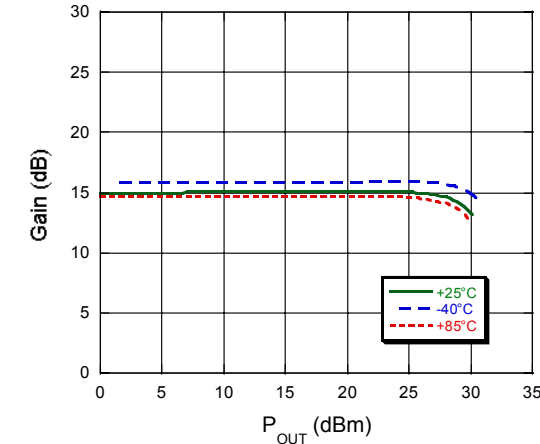

Output IP3

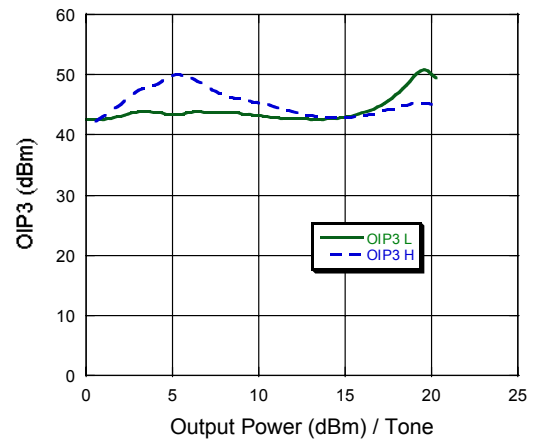

Applications Section

Typical Performance Curves, 300 MHz Configuration

Gain

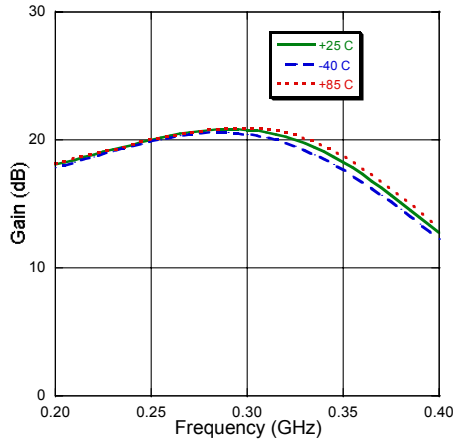

Input Return Loss

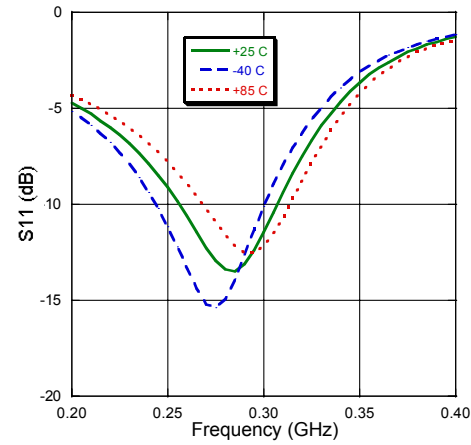

Output Return Loss

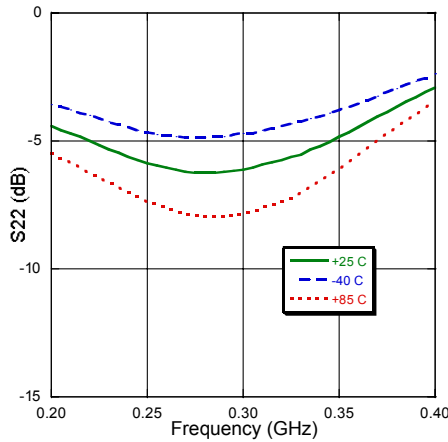

Output IP3

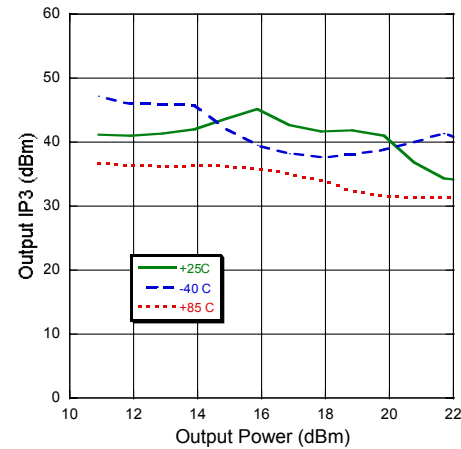

P1dB

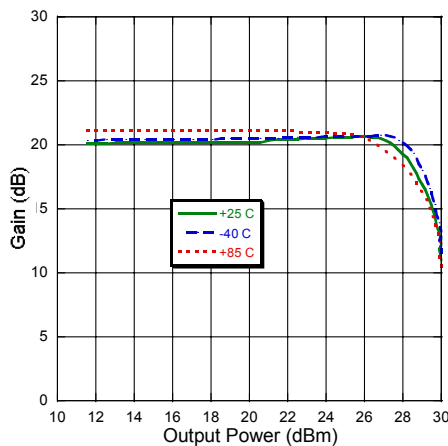

Applications Section

Typical Performance Curves, 2400 MHz Configuration

Gain

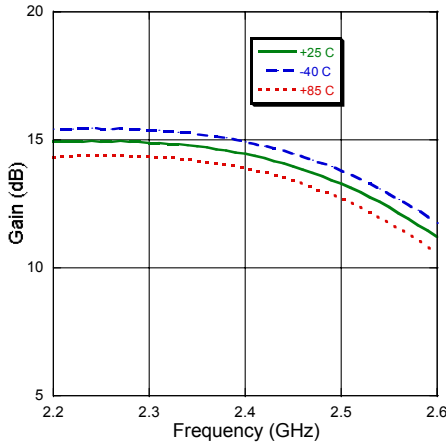

Input Return Loss

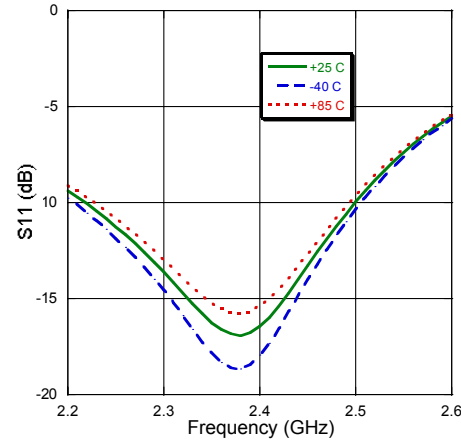

Output Return Loss

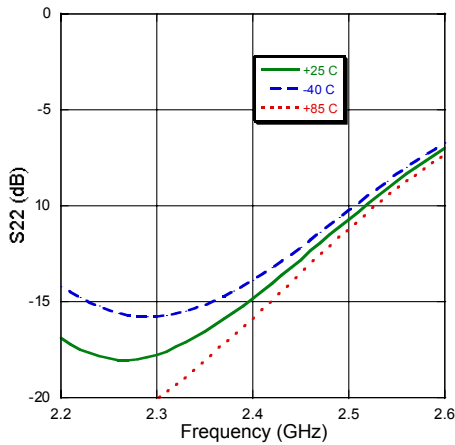

Output IP3

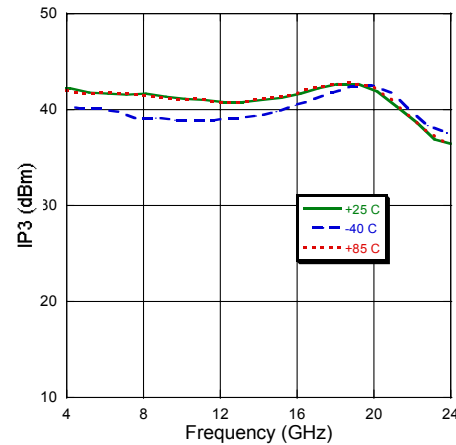

P1dB

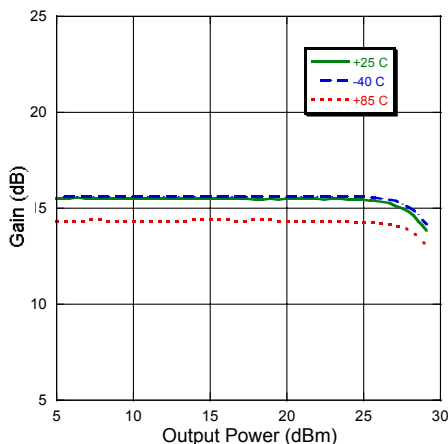

Applications Section

Typical Performance Curves, 3500 MHz Configuration

Gain

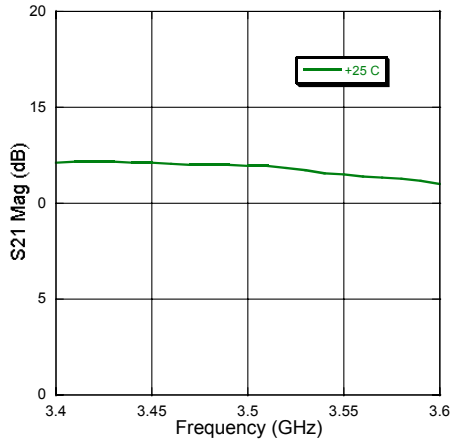

Input Return Loss

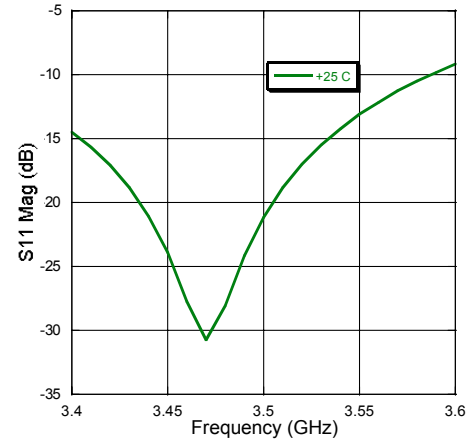

Output Return Loss

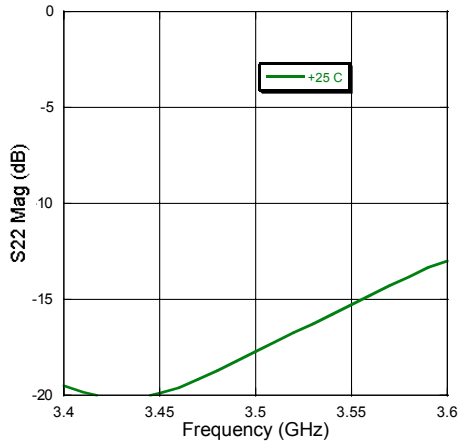

Output IP3

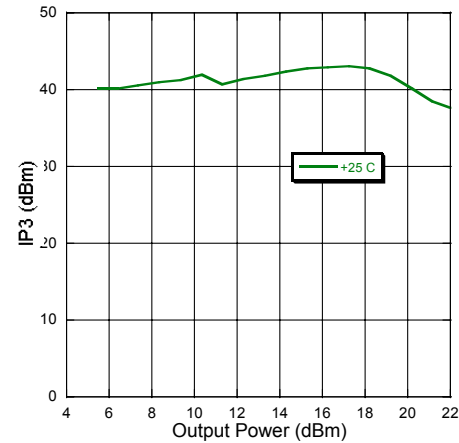

P1dB

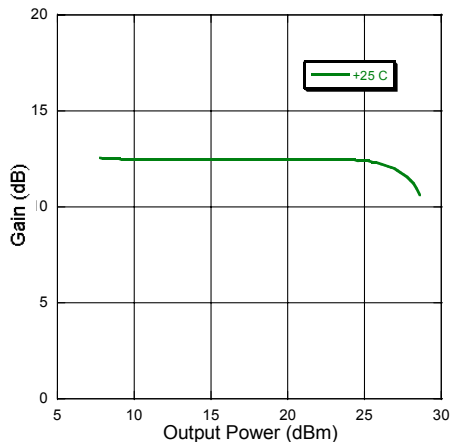

Applications Section

300 MHz PCB Layout

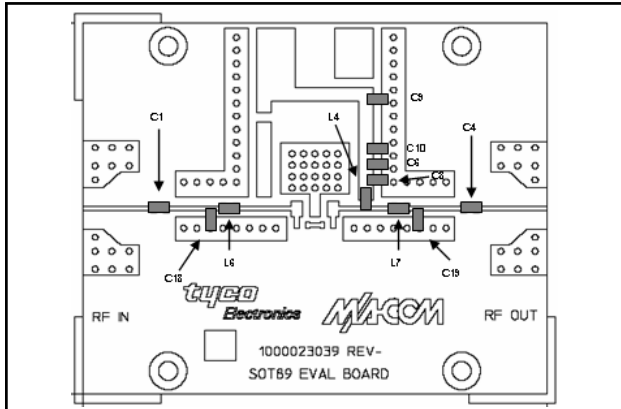

300 MHz Schematic

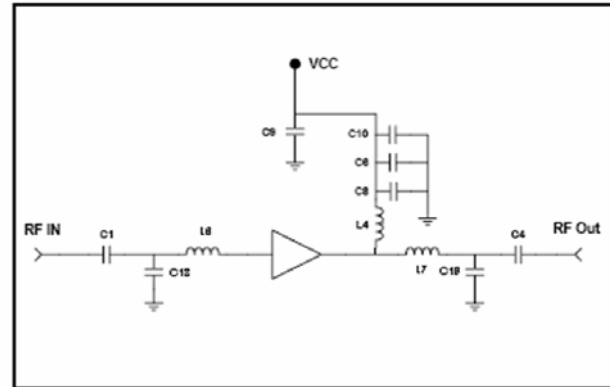

2400 MHz PCB Layout

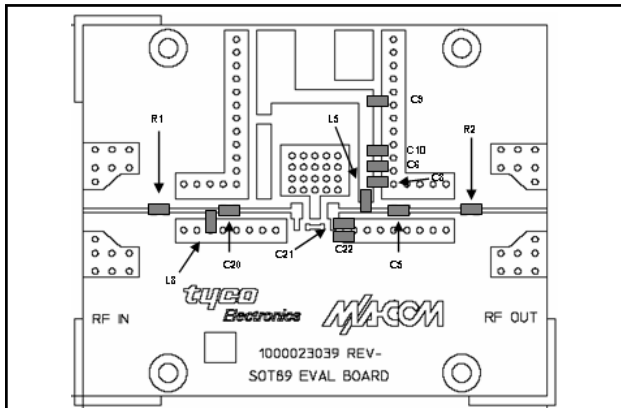

2400 MHz Schematic

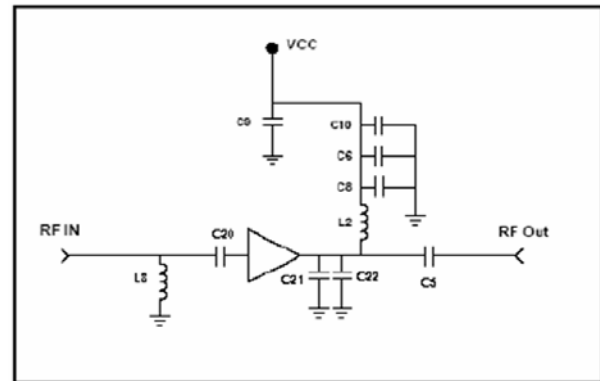

3500 MHz PCB Layout

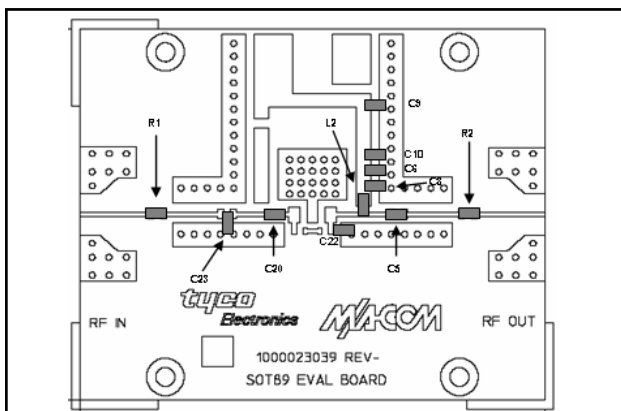

3500 MHz Schematic

