

RF Driver Amplifier
300 - 4000 MHz

MAAMSS0071
V2

Features

- Output Intercept Point of +37 dBm over a 20 dB Input Power Range
- Broadband Operation
- Lead-Free SOT-89 Package
- 100% Matte Tin Plating over Copper
- Halogen-Free “Green” Mold Compound
- RoHS* Compliant and 260°C Reflow Compatible

Description

M/A-COM’s MAAMSS0071 RF driver amplifier is a GaAs MMIC which exhibits exceptional linearity performance over a dynamic range greater than 20 dB, as well as high gain in a lead-free miniature SOT-89 surface mount plastic package. The device runs off a single +5 volt supply and draws 100 mA typically.

The MAAMSS0071 is fabricated using an HBT process to realize low current and high linearity. The process features full passivation for increased performance and reliability.

Functional Schematic

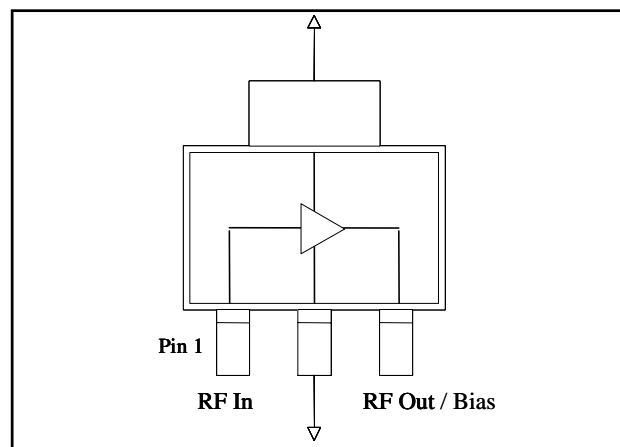

Pin Configuration

Pin No.	Function	Pin No.	Function
1	RF Input	3	RF Output/ Bias
2	Ground		

Ordering Information ¹

Part Number	Package
MAAMSS0071TR-3000	3000 piece reel
MAAM-000071-001SMB	2140 MHz Configuration
MAAM-000071-002SMB	900 MHz Configuration
MAAM-000071-003SMB	1900 MHz Configuration
MAAM-000071-004SMB	2500 MHz Configuration
MAAM-000071-005SMB	3500 MHz Configuration
MAAM-000071-000SMB	Sample Only, General Frequency

1. Reference Application Note M513 for reel size information.

Maximum Operating Conditions ^{2,3}

Parameter	Maximum Operating Conditions
Junction Temperature	160°C
RF Output Power	26 dBm
Operating Temperature	-40 °C to +85 °C

2. Operating at or within these conditions will ensure MTTF > 1 x 10⁶ hours.
3. Typical thermal resistance (Θ_{jc}) = 80°C/W.

Absolute Maximum Ratings ^{4,5}

Parameter	Absolute Maximum
RF Output Power	27 dBm
Voltage	6 volts
Storage Temperature	-65 °C to +150 °C
Junction Temperature	200°C

4. Exceeding any one or combination of these limits may cause permanent damage to this device.
5. M/A-COM does not recommend sustained operation near these survivability limits.

* Restrictions on Hazardous Substances, European Union Directive 2002/95/EC.

RF Driver Amplifier
300 - 4000 MHz

MAAMSS0071
V2

Electrical Specifications: $T_A = 25^\circ\text{C}$, $V_{CC} = 5\text{ V}$, $Z_0 = 50\text{ Ohms}$

Parameter	Test Conditions	Units	Min.	Typ.	Max.
Gain	2140 MHz	dB	14.5	16	—
Input Return Loss	2140 MHz	dB	—	13	—
Output Return Loss	2140 MHz	dB	—	18	—
Output P1dB	2140 MHz	dBm	—	26	—
Output IP3	(+15 dBm / tone, 1 MHz spacing) 2140 MHz	dBm	35	37	—
Noise Figure	2140 MHz	dB	—	3.2	—
Quiescent Current	2140 MHz	mA	—	100	—
Current	(+15 dBm / tone, 1 MHz spacing) 2140 MHz	mA	75	115	150

2140 MHz PCB Layout

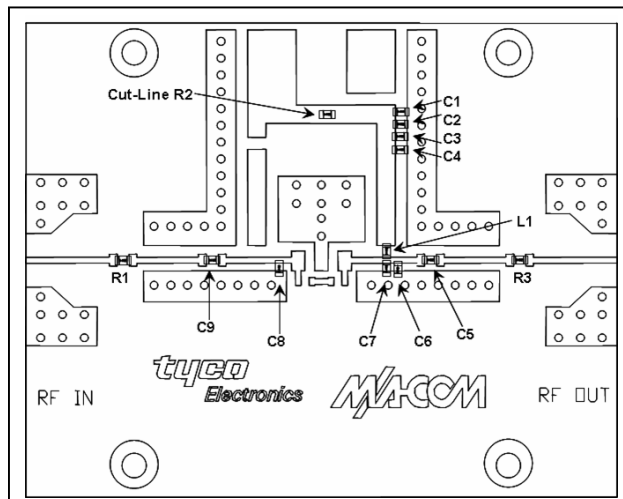

Parts List

Part	Value	Case Style	Manufacturer
C1,C2,C3,C4	0.1 μF	0402	Murata
C5	39 pF	0402	Murata
C6	1 pF	0402	Murata
C7	0.5 pF	0402	Murata
C8	3 pF	0402	Murata
C9	15pF	0402	Murata
L1	7.5 nH	0402	Coilcraft
R1,R3	0 Ω	0402	Panasonic
R2	2.4 Ω	0402	Panasonic

Typical Performance Curves, 2140 MHz Configuration

Gain

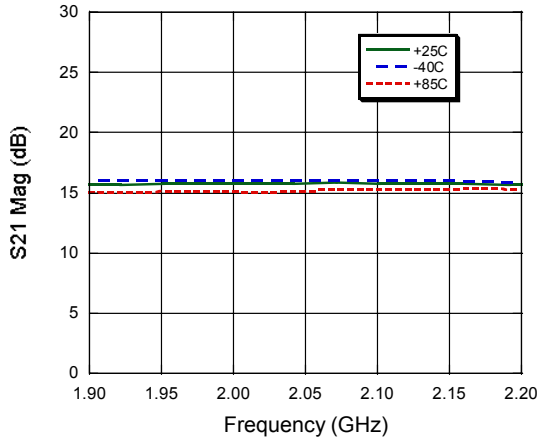

Input Return Loss

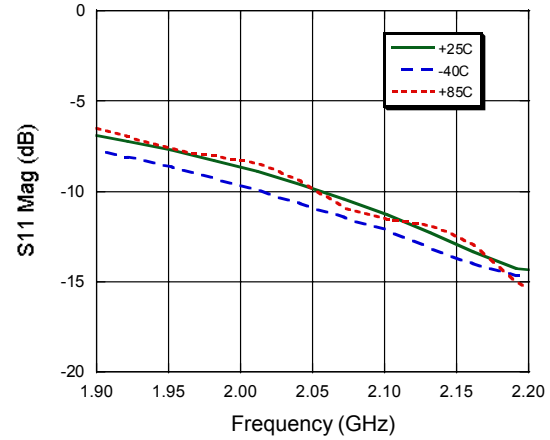

Output Return Loss

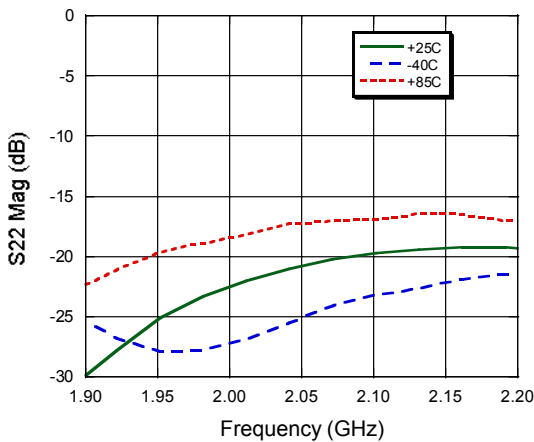

Noise Figure @ 2150 MHz

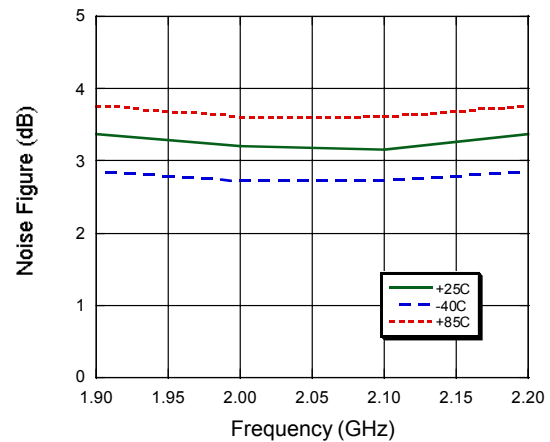

P1dB

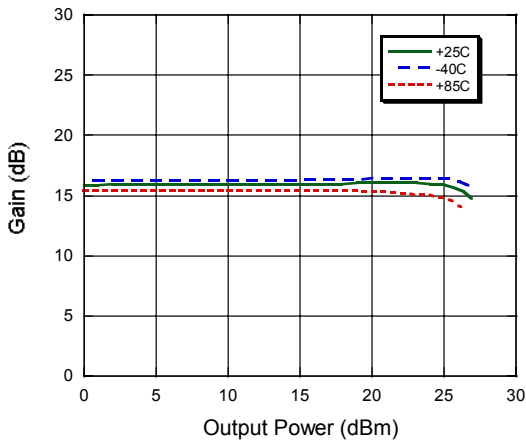

Output IP3

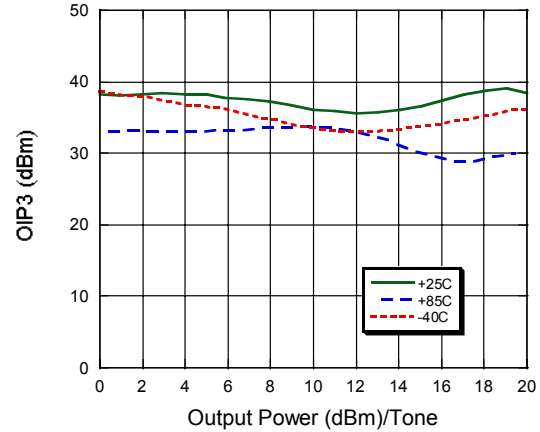

Typical Performance Curves, 2140 MHz Configuration

I_{CC} VS. P_{OUT}

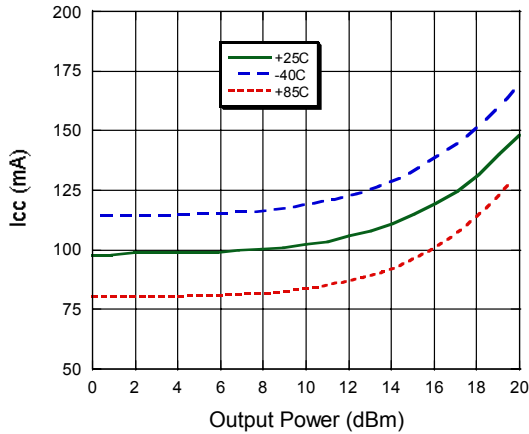

Handling Procedures

Please observe the following precautions to avoid damage:

Static Sensitivity

Gallium Arsenide Integrated Circuits are sensitive to electrostatic discharge (ESD) and can be damaged by static electricity. Proper ESD control techniques should be used when handling these devices.

Lead-Free SOT-89 Plastic Package[†]

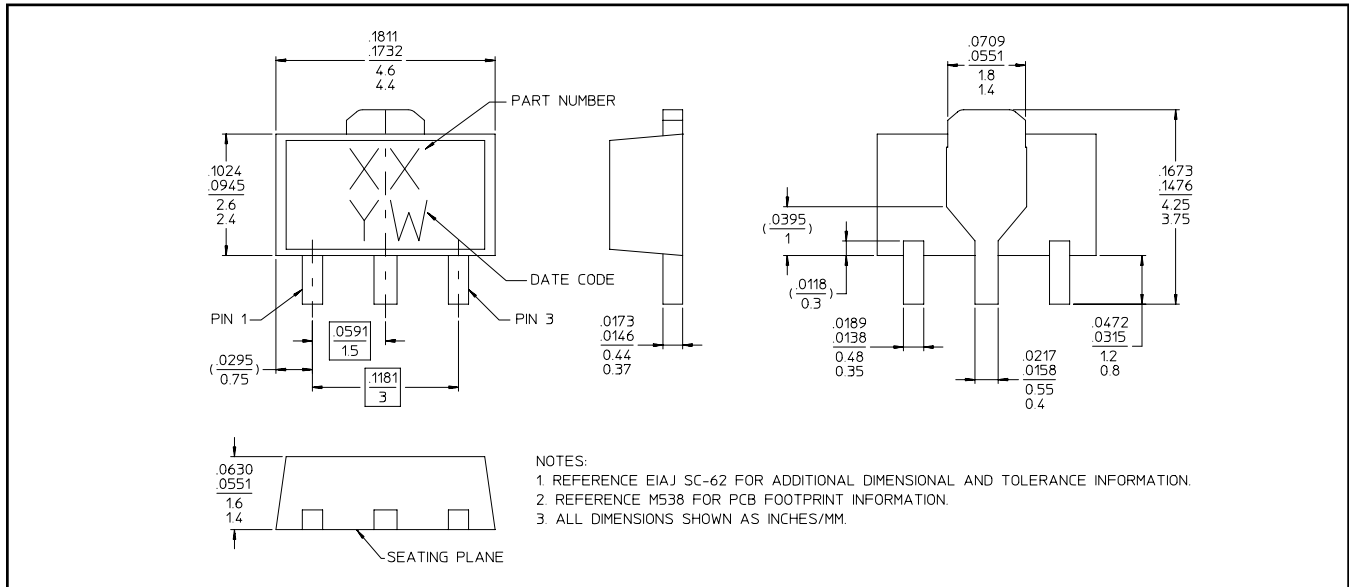

[†] Reference Application Note M538 for lead-free solder reflow recommendations. Meets JEDEC moisture sensitivity level 1 requirements.

Applications Section

Typical Performance Curves, 900 MHz Configuration

Gain

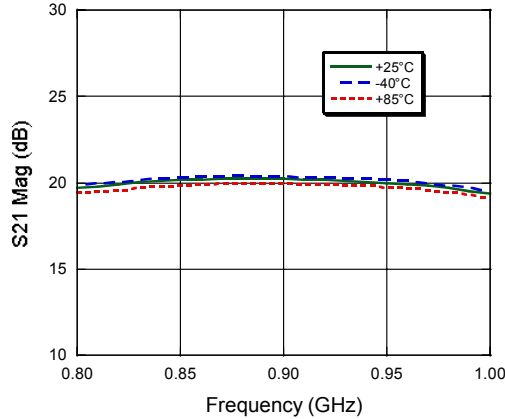

Input Return Loss

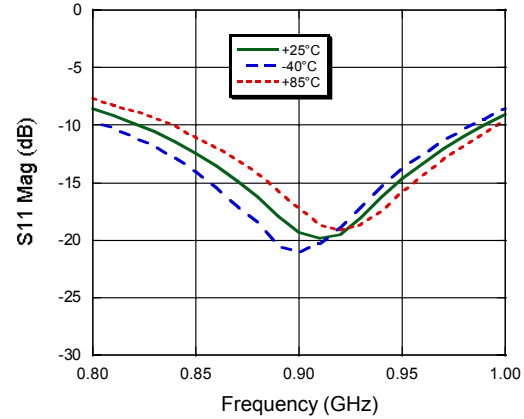

Output Return Loss

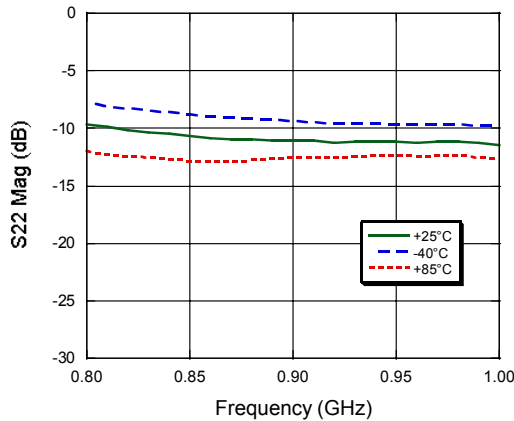

Noise Figure

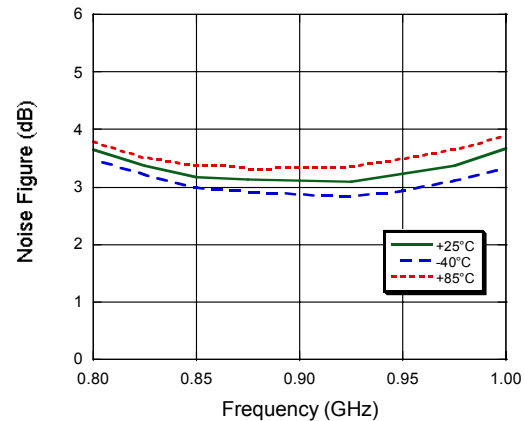

P1dB

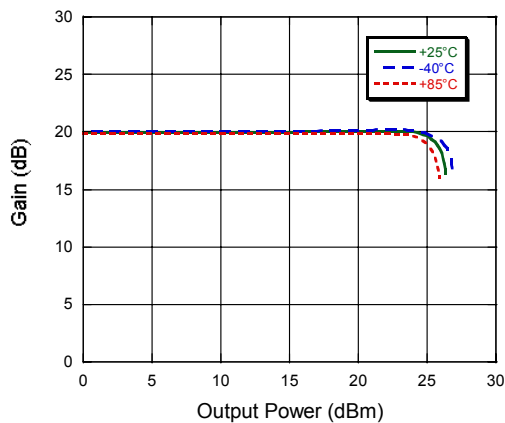

Output IP3

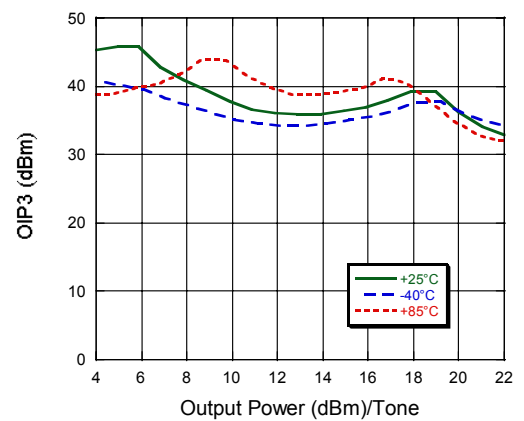

Applications Section

Typical Performance Curves, 900 MHz Configuration

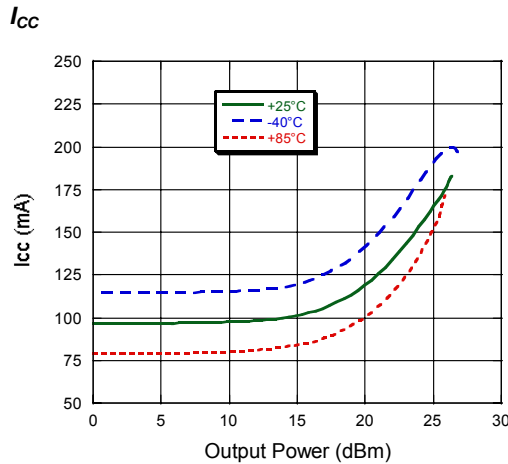

Parts List

Part	Value	Case Style	Manufacturer
C1,C2	0.1 μ F	0402	Murata
C3,C5,C8	1000 pF	0402	Murata
C4	15 pF	0402	Murata
C6	4 pF	0402	Murata
C7	5.6 pF	0402	Murata
L1	1nH	0402	Coilcraft
L2	7.5 nH	0402	Coilcraft
L3	4.7nH	0402	Coilcraft
R1	2.4 Ω	0402	Panasonic

900 MHz PCB Layout

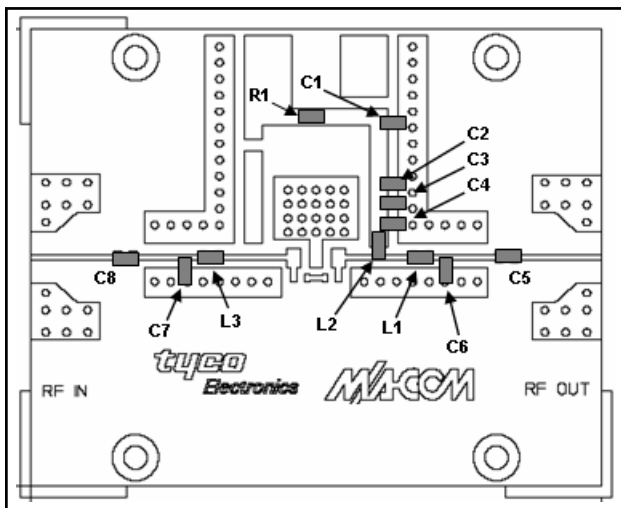

900 MHz Schematic

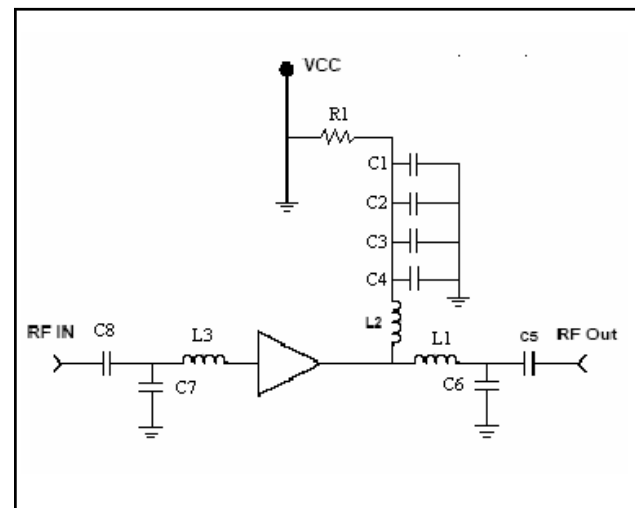

Applications Section

Typical Performance Curves, 1900 MHz Configuration

Gain

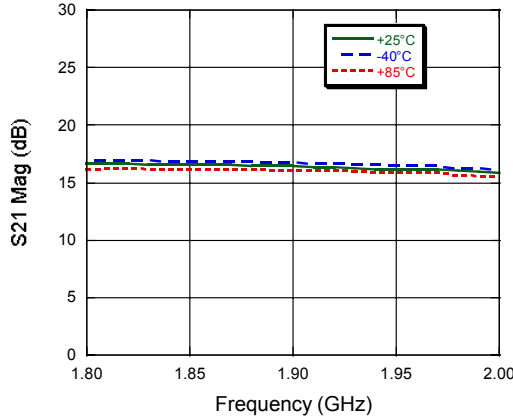

Input Return Loss

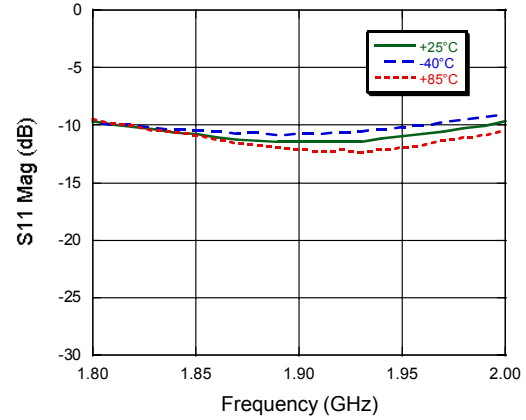

Output Return Loss

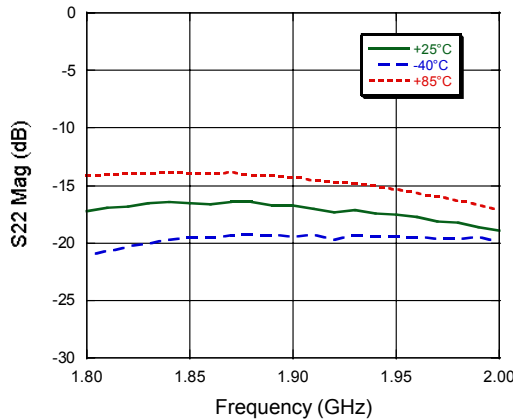

Noise Figure

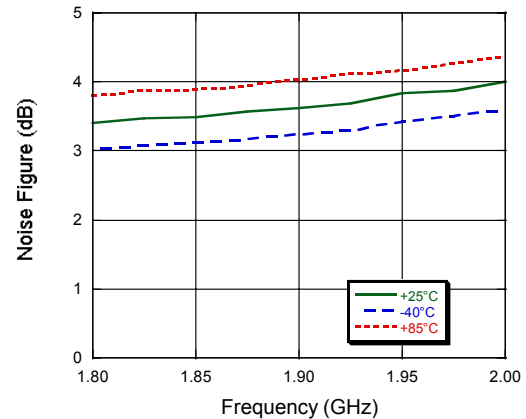

P1dB

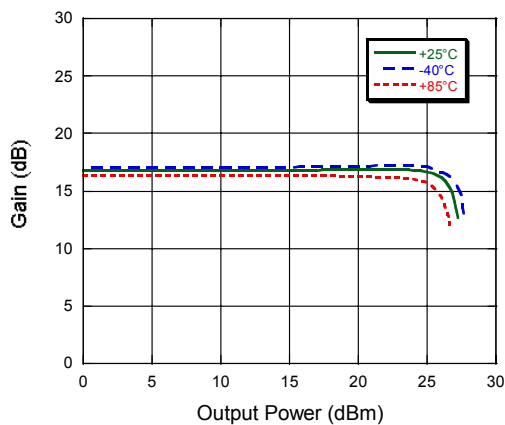

Output IP3

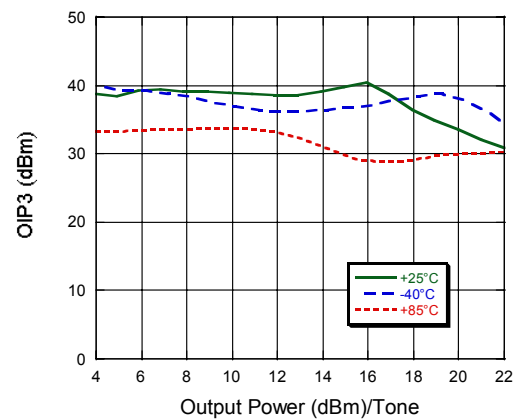

Applications Section

Typical Performance Curves, 1900 MHz Configuration

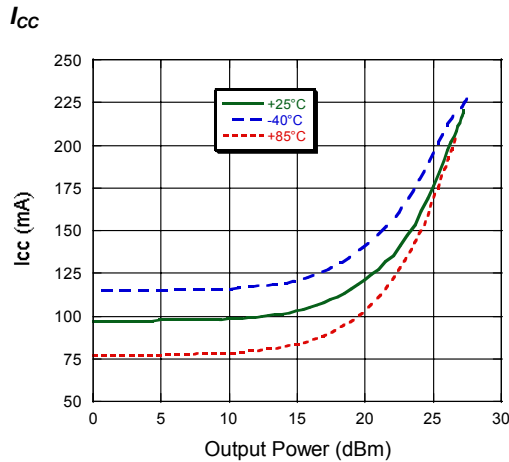

Parts List

Part	Value	Case Style	Manufacturer
C1,C2,C3,C4	0.1 μ F	0402	Murata
C5	39 pF	0402	Murata
C6	1.8 pF	0402	Murata
C7	4 pF	0402	Murata
C8	12 pF	0402	Murata
L1	7.5 nH	0402	Coilcraft
R1	2.4 Ω	0402	Panasonic
R2,R3	0 Ω	0402	Panasonic

1900 MHz PCB Layout

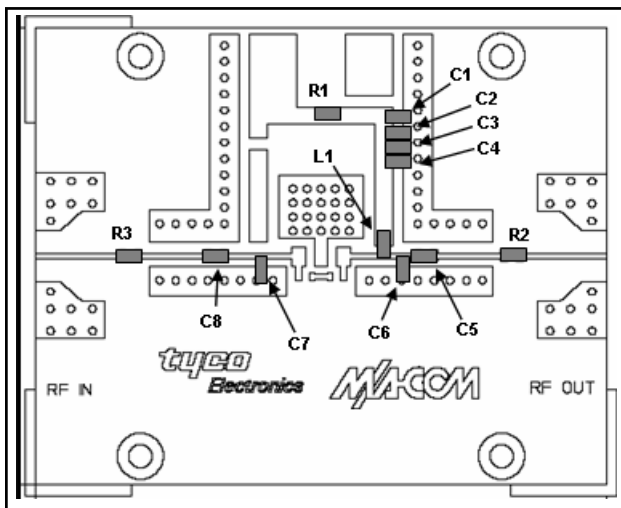

1900 MHz Schematic

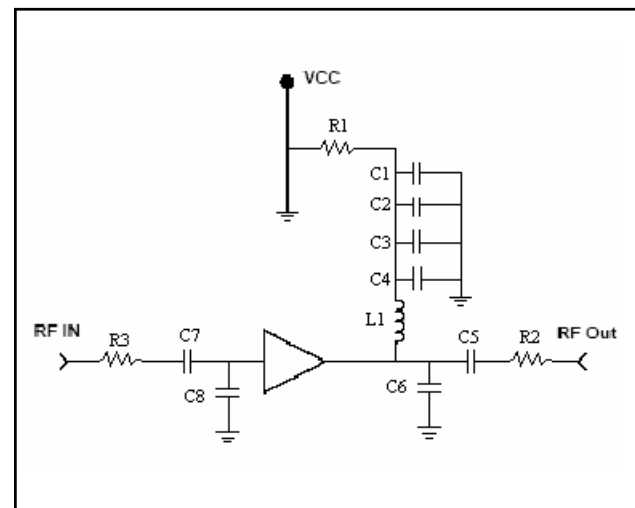

Applications Section

Typical Performance Curves, 2500 MHz Configuration

Gain

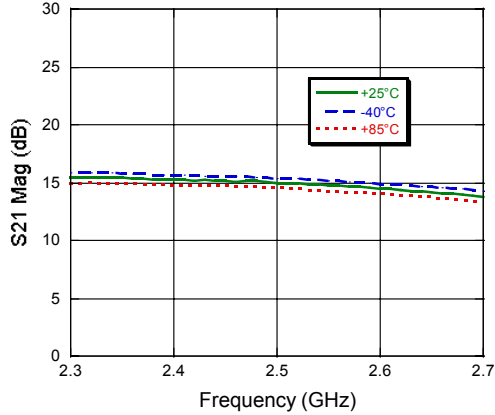

Input Return Loss

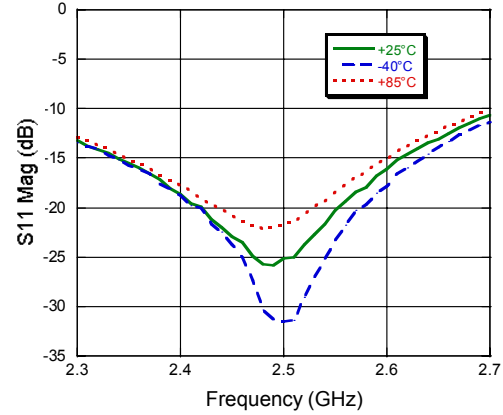

Output Return Loss

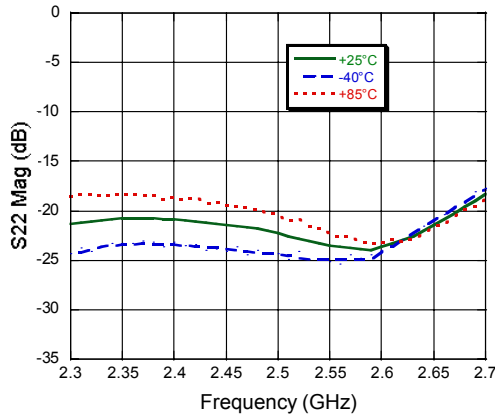

Noise Figure

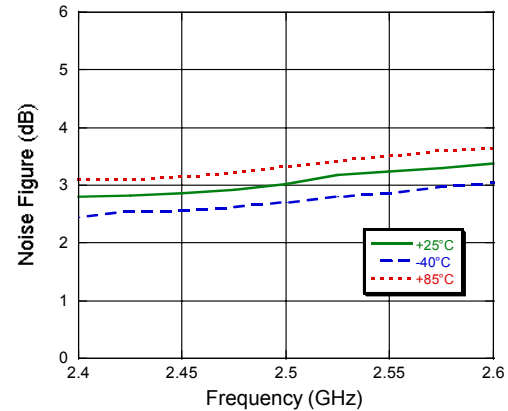

P1dB

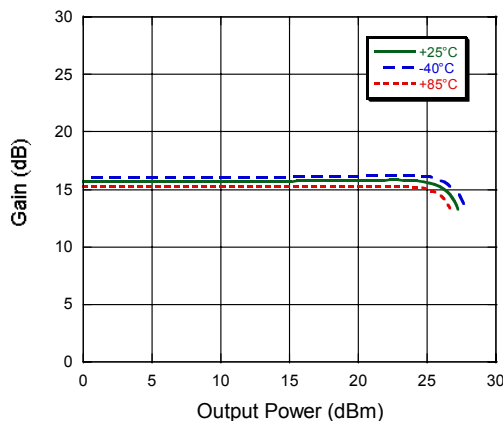

Output IP3

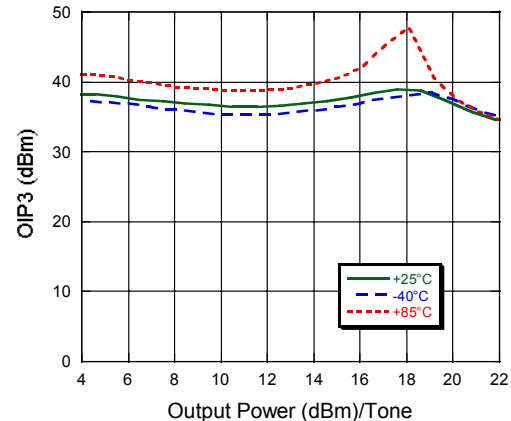

Applications Section

Typical Performance Curves, 2500 MHz Configuration

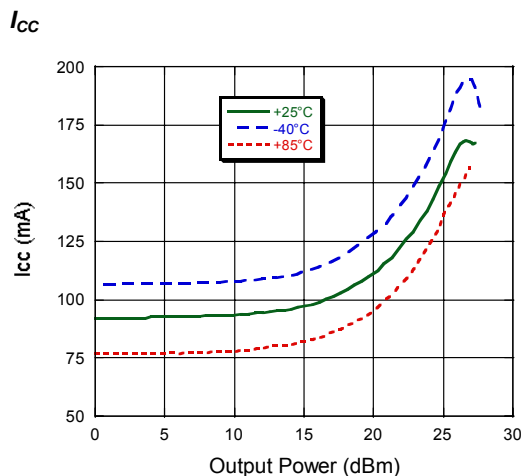

Parts List

Part	Value	Case Style	Manufacturer
C1,C2,C3,C4	0.1 μF	0402	Murata
C5	39 pF	0402	Murata
C6	1 pF	0402	Murata
C7	0.5 pF	0402	Murata
C8	2 pF	0402	Murata
C9	15 pF	0402	Murata
L1	7.5 nH	0402	Coilcraft
R1	2.4 Ω	0402	Panasonic
R2,R3	0 Ω	0402	Panasonic

2500 MHz PCB Layout

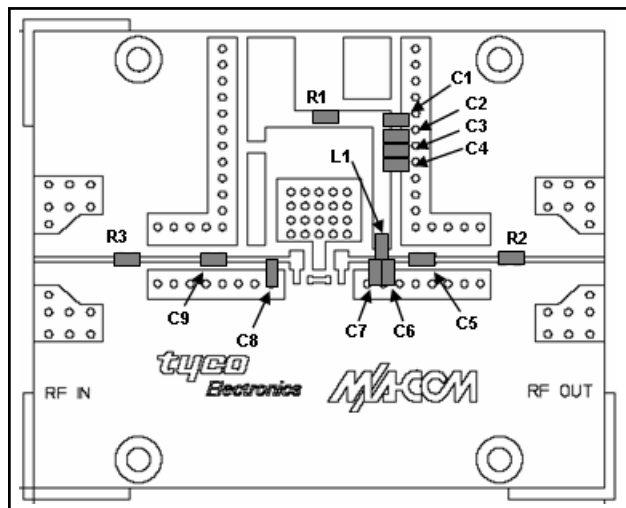

2500 MHz Schematic

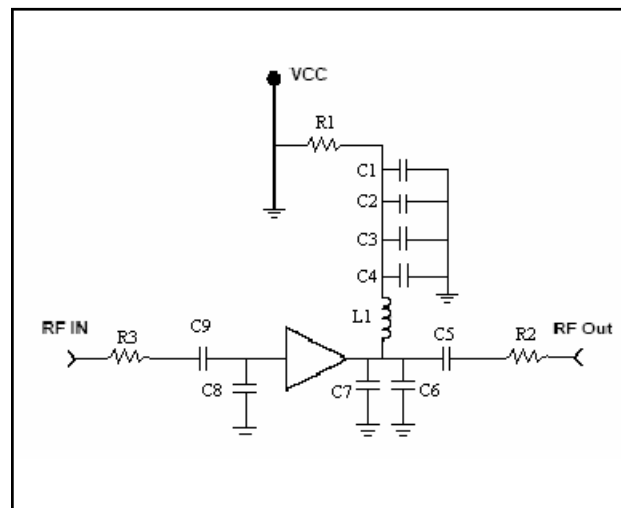

Applications Section

Typical Performance Curves, 3500 MHz Configuration

Gain

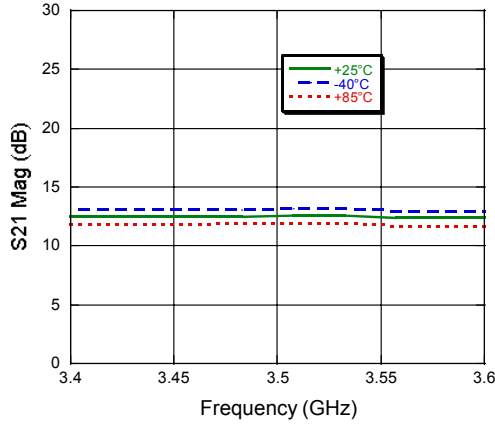

Input Return Loss

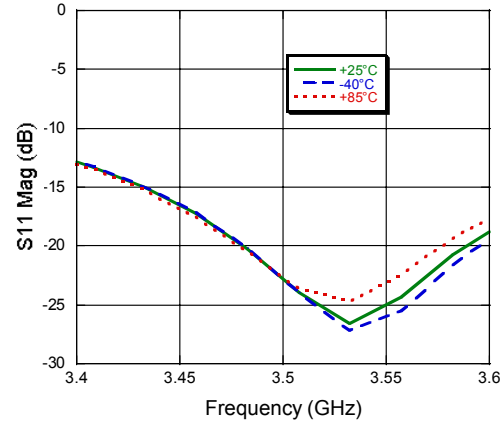

Output Return Loss

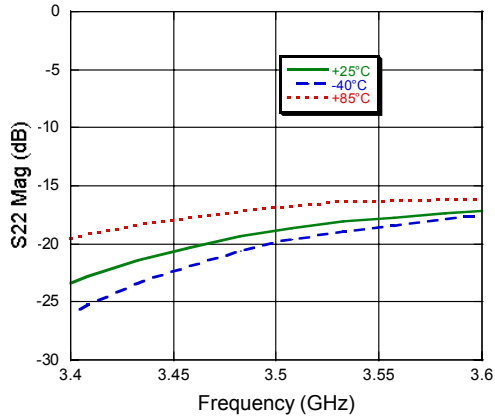

Noise Figure

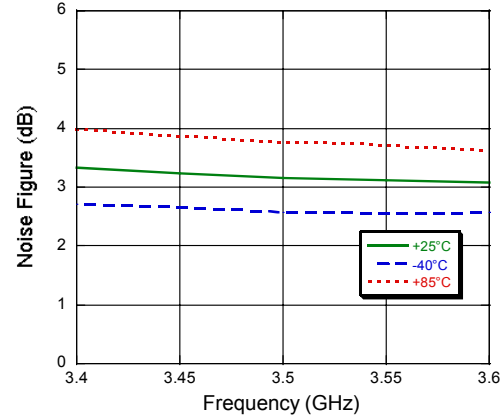

P1dB

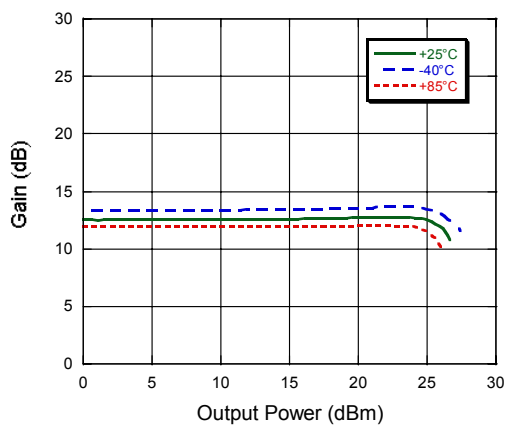

Output IP3

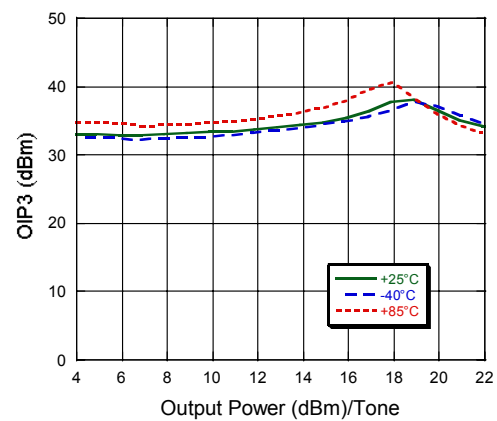

Applications Section

Typical Performance Curves, 3500 MHz Configuration

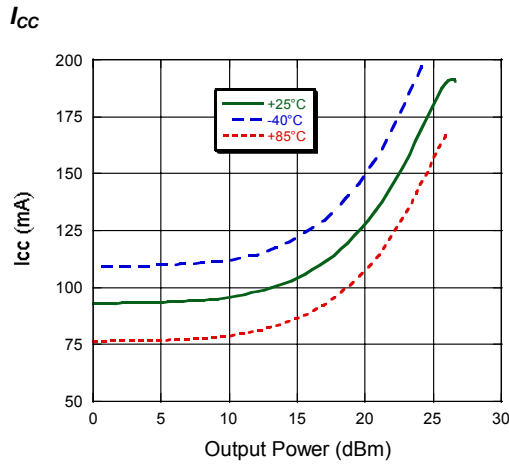

Parts List

Part	Value	Case Style	Manufacturer
C1	0.1 μ F	0402	Murata
C2	1000 pF	0402	Murata
C3	15 pF	0402	Murata
C4	39 pF	0402	Murata
C5,C6	0.5 pF	0402	Murata
C7	39 pF	0402	Murata
L1	5.6 nH	0402	Coilcraft
L2	1.9 nH	0402	Coilcraft
R1	2.4 Ω	0402	Panasonic
R2,R3	0 Ω	0402	Panasonic

3500 MHz PCB Layout

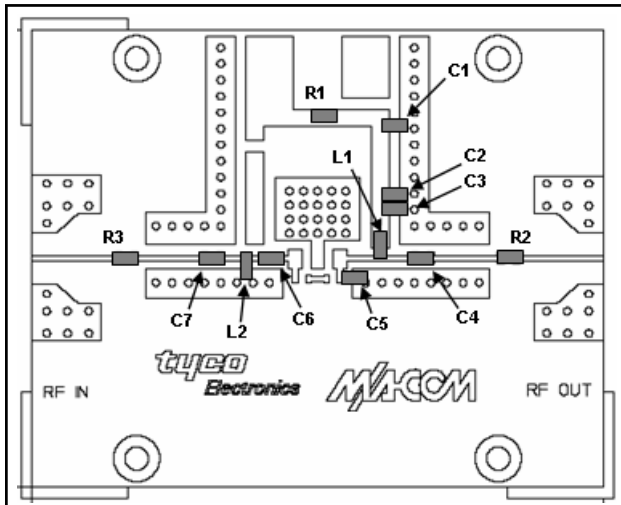

3500 MHz Schematic

