

Features

- Tunable over a wide frequency range
- Output Intercept Point of up to +45 dBm
- Excellent ACPR performance
- High Efficiency
- Lead-Free SOIC-8EP Package
- 100% Matte Tin Plating over Copper
- Halogen-Free "Green" Mold Compound
- RoHS* Compliant and 260°C Reflow Compatible

Description

M/A-COM's MAAMSS0058 RF driver amplifier is a two stage GaAs MMIC which exhibits exceptional linearity performance as well as featuring high gain in a lead-free SOIC-8EP surface mount plastic package. The device runs off a single +5 volt supply and draws 1100 mA typically.

The MAAMSS0058 is fabricated using a high reliability GaAs HBT process to realize low current and high power functionality. The process features full passivation for increased performance and reliability.

The MAAMSS0058 has been designed to be a functional driver amplifier from 250 to 4000 MHz.

Ordering Information ^{1,2}

Part Number	Package
MAAMSS0058	Bulk Packaging
MAAMSS0058TR-3000	3000 piece reel
MAAM-000058-001SMB	Sample Only, 250 - 4000 MHz tuning

1. Reference Application Note M513 for reel size information.
2. All sample boards include 5 loose parts.

Functional Block Diagram

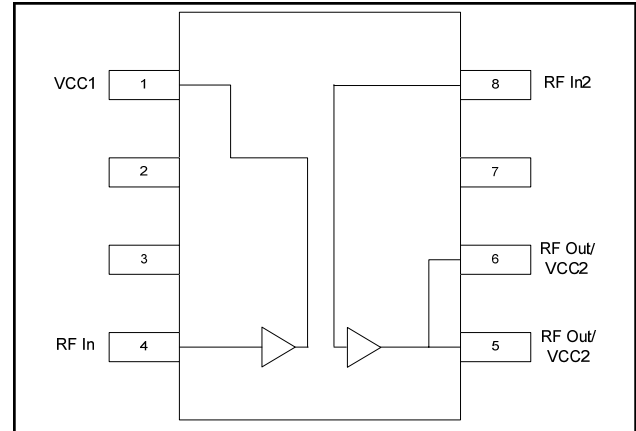

Pin Configuration

Pin No.	Pin Name	Description
1	VCC1	1st Stage VCC
2	GND	RF and DC Ground
3	GND	RF and DC Ground
4	RF In	Amp Input
5	RF Out/ VCC2	RF Out/ VCC2
6	RF Out/ VCC2	RF Out/ VCC2
7	GND	RF and DC Ground
8	RF In2	RF In Stage 2

Absolute Maximum Ratings ^{3,4,5}

Parameter	Absolute Maximum
RF Output Power	34 dBm
Voltage	6.5 volts
Operating Temperature	-40°C to +85°C
Storage Temperature	-65°C to +150°C

3. Exceeding any one or combination of these limits may cause permanent damage to this device.
4. M/A-COM does not recommend sustained operation near these survivability limits.
5. This amplifier has been designed to operate optimally in linear mode and will not function reliably in compressed or saturated mode.

* Restrictions on Hazardous Substances, European Union Directive 2002/95/EC.

ADVANCED: Data Sheets contain information regarding a product M/A-COM is considering for development. Performance is based on target specifications, simulated results, and/or prototype measurements. Commitment to develop is not guaranteed.

PRELIMINARY: Data Sheets contain information regarding a product M/A-COM has under development. Performance is based on engineering tests. Specifications are typical. Mechanical outline has been fixed. Engineering samples and/or test data may be available. Commitment to produce in volume is not guaranteed.

- **North America** Tel: 800.366.2266 / Fax: 978.366.2266
- **Europe** Tel: 44.1908.574.200 / Fax: 44.1908.574.300
- **Asia/Pacific** Tel: 81.44.844.8296 / Fax: 81.44.844.8298

Visit www.macom.com for additional data sheets and product information.

M/A-COM Inc. and its affiliates reserve the right to make changes to the product(s) or information contained herein without notice.

RF Driver Amplifier
250 - 4000 MHz

M/A-COM Products
Preliminary - Rev. V1P

Electrical Specifications: $T_A = 25^\circ\text{C}$, $V_{CC} = 5\text{V}$, $Z_0 = 50\Omega$

Parameter	Test Conditions	Units	Min.	Typ.	Max.
Gain	2140 MHz	dB	—	20	—
Input Return Loss	2140 MHz	dB	—	12	—
Output Return Loss	2140 MHz	dB	—	10	—
Output P1dB	2140 MHz	dB	—	33	—
Output IP3	(+23 dBm / tone, 1 MHz spacing) 2140 MHz	dBm	—	45	—
Channel Power	(@ -45 dBc ACPR, IS-95 9 channels fwd) 2140 MHz	dB	—	TBD	—
Noise Figure	2140 MHz	dB	—	5.5	—
Quiescent Current	+5 V	mA	—	1100	—

Lead-Free SOIC-8EP†

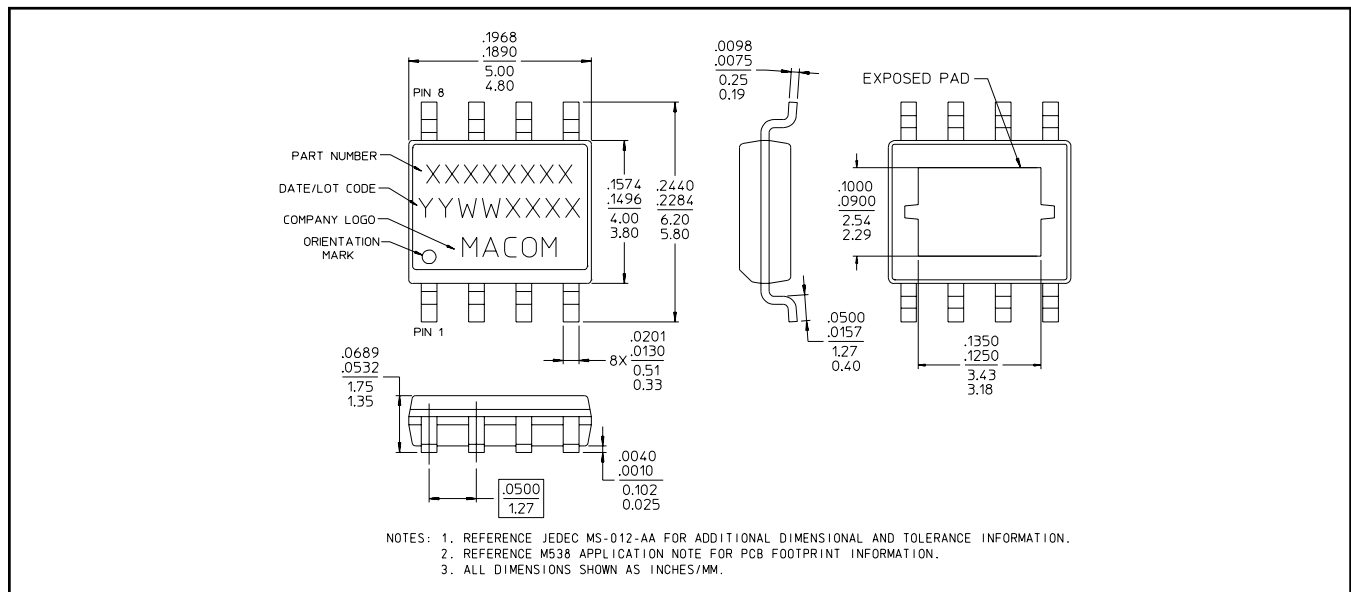

† Reference Application Note M538 for lead-free solder reflow recommendations.
Meets JEDEC moisture sensitivity level 1 requirements.

2

ADVANCED: Data Sheets contain information regarding a product M/A-COM is considering for development. Performance is based on target specifications, simulated results, and/or prototype measurements. Commitment to develop is not guaranteed.

PRELIMINARY: Data Sheets contain information regarding a product M/A-COM has under development. Performance is based on engineering tests. Specifications are typical. Mechanical outline has been fixed. Engineering samples and/or test data may be available. Commitment to produce in volume is not guaranteed.

- **North America** Tel: 800.366.2266 / Fax: 978.366.2266
- **Europe** Tel: 44.1908.574.200 / Fax: 44.1908.574.300
- **Asia/Pacific** Tel: 81.44.844.8296 / Fax: 81.44.844.8298

Visit www.macom.com for additional data sheets and product information.

M/A-COM Inc. and its affiliates reserve the right to make changes to the product(s) or information contained herein without notice.

RF Driver Amplifier
250 - 4000 MHz

M/A-COM Products
Preliminary - Rev. V1P

Recommended PCB Layout

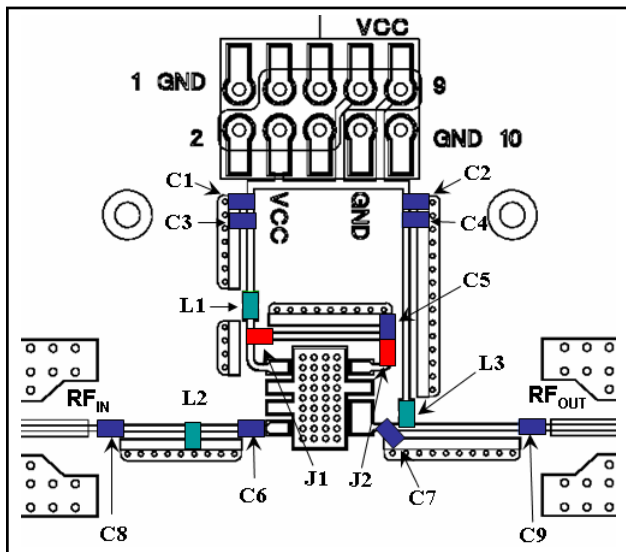

2140 MHz Schematic

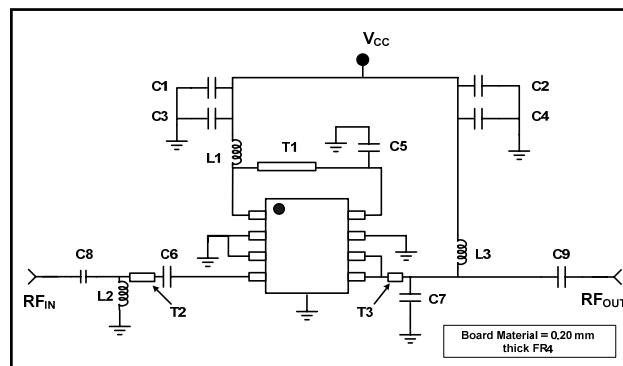

Transmission Line Dimensions

Designator	Length (mil) *	Width (mil)
T1	355	15.0
T2	125	15.0
T3	20	15.0

* From package edge to center of component

Parts List

Part	Value	Case Style	Manufacturer	Purpose
C1, C2	0.1 μ F	0402	Murata	Bypass
C3, C4, C8, C9	1000 pF	0402	Murata	Bypass
C5	1.2 pF	0402	Murata	Interstage Match
C6	1.0 pF	0402	Murata	Input Match
C7	3.3 pF	0402	ATC	Output Match
L1	7.5 nH	0402	Coilcraft	Bias Injection
L2	1.5 nH	0402	Toko	Input Match
L3	8.2 nH	0402	Coilcraft	Bias Injection
J1, J2	-	-	-	Jumper

Cross Section View

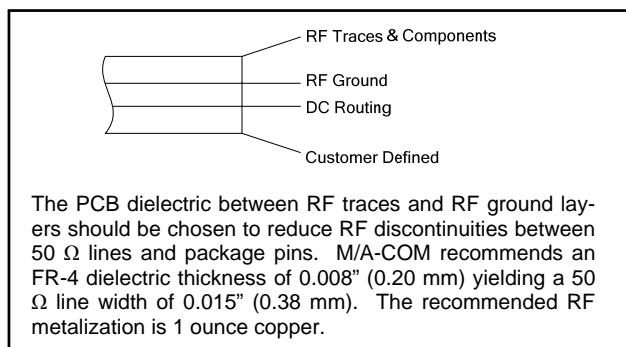

Handling Procedures

Please observe the following precautions to avoid damage:

Static Sensitivity

Gallium Arsenide Integrated Circuits are sensitive to electrostatic discharge (ESD) and can be damaged by static electricity. Proper ESD control techniques should be used when handling these devices.

- **North America** Tel: 800.366.2266 / Fax: 978.366.2266
- **Europe** Tel: 44.1908.574.200 / Fax: 44.1908.574.300
- **Asia/Pacific** Tel: 81.44.844.8296 / Fax: 81.44.844.8298

Visit www.macom.com for additional data sheets and product information.

M/A-COM Inc. and its affiliates reserve the right to make changes to the product(s) or information contained herein without notice.

ADVANCED: Data Sheets contain information regarding a product M/A-COM is considering for development. Performance is based on target specifications, simulated results, and/or prototype measurements. Commitment to develop is not guaranteed.
PRELIMINARY: Data Sheets contain information regarding a product M/A-COM has under development. Performance is based on engineering tests. Specifications are typical. Mechanical outline has been fixed. Engineering samples and/or test data may be available. Commitment to produce in volume is not guaranteed.

Typical Performance Curves, 2140 MHz Configuration

Gain

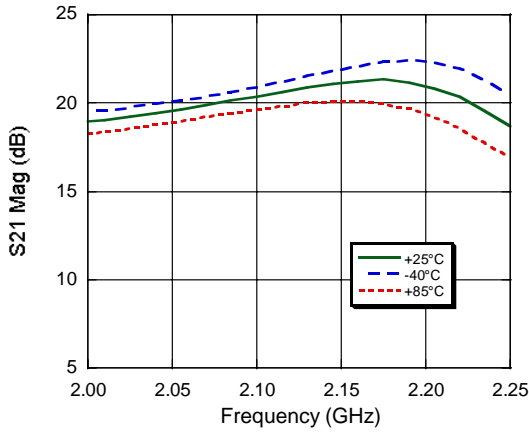

Input Return Loss

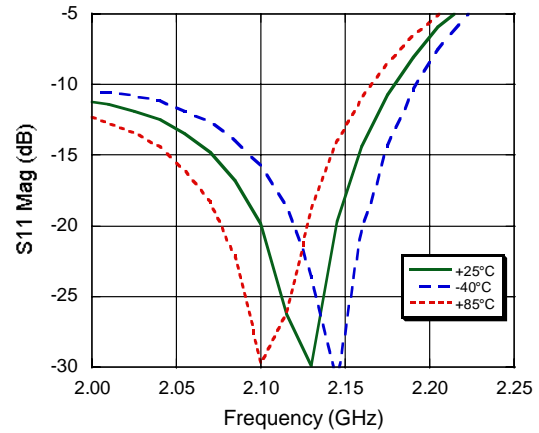

Output Return Loss

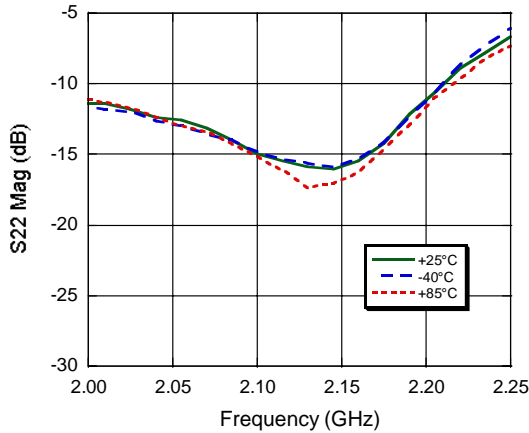

Noise Figure

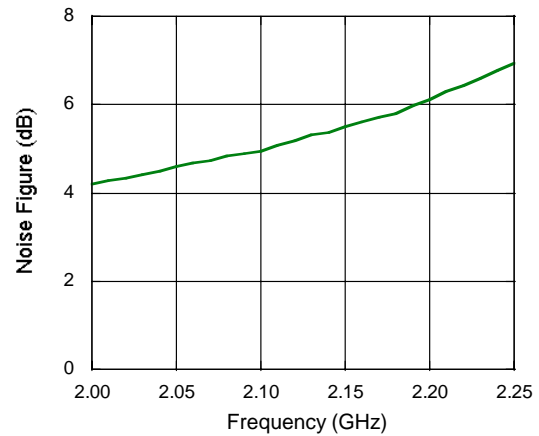

P1dB @ 2140 MHz

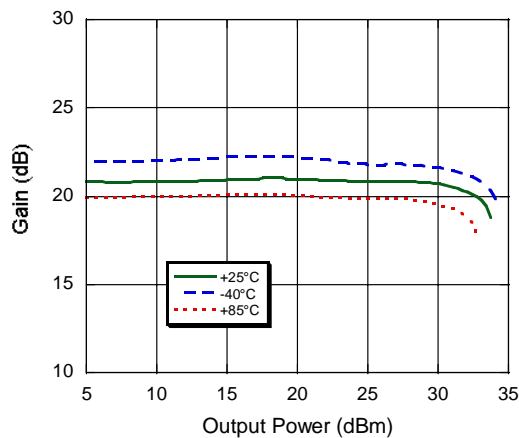

Output IP3 @ 2170 MHz

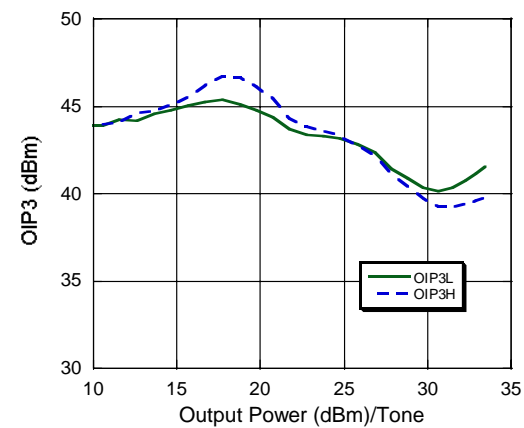

ADVANCED: Data Sheets contain information regarding a product M/A-COM is considering for development. Performance is based on target specifications, simulated results, and/or prototype measurements. Commitment to develop is not guaranteed.

PRELIMINARY: Data Sheets contain information regarding a product M/A-COM has under development. Performance is based on engineering tests. Specifications are typical. Mechanical outline has been fixed. Engineering samples and/or test data may be available. Commitment to produce in volume is not guaranteed.

- **North America** Tel: 800.366.2266 / Fax: 978.366.2266
- **Europe** Tel: 44.1908.574.200 / Fax: 44.1908.574.300
- **Asia/Pacific** Tel: 81.44.844.8296 / Fax: 81.44.844.8298

Visit www.macom.com for additional data sheets and product information.

M/A-COM Inc. and its affiliates reserve the right to make changes to the product(s) or information contained herein without notice.