

DATA SHEET

SKY65146: 3.5 V Broadband MCM Power Amplifier 806–849 MHz

Applications

- iDEN® (806–825 MHz)
- TETRA (806–825 MHz)
- TDMA (824–849 MHz)
- AMPS (824–849 MHz)
- Wireless Local Loop (WLL)

Features

- Low voltage positive bias supply (3.5 V)
- High gain 39 dB, high power: P_{SAT} 35.6 dBm
- High efficiency: PAE 51%
- Good linearity
- Dual mode operation
- Large dynamic range
- 28-pin LCC package (10 x 13.97 x 1.45 mm)
- Internal RF match
- Power down control
- Available on tape and reel
- Available lead (Pb)-free and RoHS-compliant

Description

The SKY65146 is a fully matched 28-pin surface mount multi-chip module (MCM) amplifier designed for Private Mobile Radio, Wireless Local Loop, and TDMA/AMPS mobile units operating in the 806-849 MHz cellular bandwidth. Microwave Monolithic Integrated Circuits (MMICs), comprised of Gallium Arsenide (GaAs) and Si CMOS, contain all active circuitry in the module, which includes on-board bias circuitry as well as the interstage matching circuit. The input and output match is realized off-chip within the module package to optimize efficiency and high power performance ($P3\ dB_{sat} \cong 35.6\ dBm$) into a $50\ \Omega$ load.

Primary bias to the SKY65146 can be supplied directly from a single cell lithiumion or other suitable battery with a nominal output of 3.5 V.

No external supply side switch is needed as typical “off” leakage is a few microamperes with full primary voltage supplied from the battery.

Block Diagram

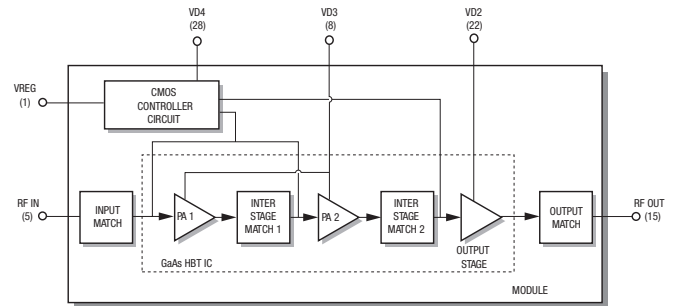

Package Diagram

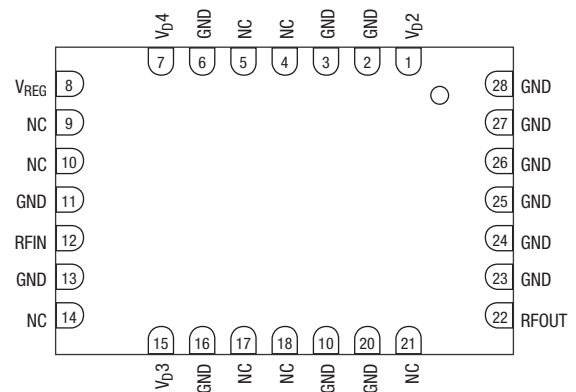

The ICs are manufactured on an advanced InGaP HBT process and on a silicon CMOS process, providing for all positive voltage DC supply operation while maintaining high efficiency and good linearity.

The module can operate over the temperature range of -40 °C to 85 °C. A populated evaluation board is available upon request.

NEW Skyworks offers lead (Pb)-free, RoHS (Restriction of Hazardous Substances)-compliant packaging.



Electrical Specifications

V_{CC} (V_D) = 3.5 V, V_{REG} = 2.75 V, Frequency = 815 MHz, T_C = 25 °C, unless otherwise specified.

| Parameter | Symbol | Condition | Min. | Typ. | Max. | Unit |
|--|-----------------------|--|------|------|------|--------|
| Frequency range | F | | 806 | | 825 | MHz |
| Gain | S ₂₁ | Small signal | | 38.7 | | dB |
| Power gain | G _p | P ₀ = 29 dBm | 35.5 | 38.7 | 40 | dB |
| Input VSWR | S ₁₁ | Small signal | 12 | 17 | | |
| Saturated output power | P _{3 dB SAT} | Gain Comp ≤ 3 dB | 35.1 | 35.6 | | dBm |
| Power added efficiency | PAE | P ₀ = P _{3 dB SAT} | 47 | 51 | | % |
| Current @ PSAT | I _{CC SAT} | P ₀ = P _{3 dB SAT} | | 2 | | A |
| Quiescent current | I _{CCQ} | No RF signal | 270 | 329 | 370 | mA |
| Harmonic Levels | 2F ₀ | P ₀ ≤ P _{3 dB SAT} | | -37 | | dBc |
| | 3F ₀ | P ₀ ≤ P _{3 dB SAT} | | -60 | | dBc |
| | 4F ₀ | P ₀ ≤ P _{3 dB SAT} | | -80 | | dBc |
| Noise power in Rx band FC + 30 MHz, BW = 18 kHz | RxBN | P ₀ ≤ 29 dBm | | | -85 | dBm/Hz |
| Noise figure | NF | CW | | 6.8 | 8 | dB |
| Stability (spurious output) | S | Output VSWR = 10:1 | | | -36 | dBm |
| Ruggedness - no damage | Ru | P ₀ ≤ 29 dBm | 15:1 | | | VSWR |

Recommended Operating Conditions

| Parameter | Symbol | Conditions | Min. | Typ. | Max. | Unit |
|-----------------------------|-------------------|------------|------|------|------|------|
| Supply voltage | V _{CC} | | 3 | 3.5 | 4.4 | V |
| Regulation voltage | V _{REG} | | 2.65 | 2.75 | 2.85 | V |
| Operating frequency | F | | 806 | | 849 | MHz |
| Continuous RMS output power | P _{ORMS} | | | 29 | 31 | dBm |
| Operating case temperature | T _C | | -40 | +25 | +85 | °C |

Absolute Maximum Ratings

| Characteristic | Value |
|--|----------------------------------|
| RF input power (P _{IN}) | 11 dBm ⁽¹⁾ |
| Supply voltage (V _{CC} & V _{REF}) | 6.9 V ⁽²⁾ |
| Supply voltage (V _{CC} & V _{REF}) | V _{CC} V ⁽³⁾ |
| Operating case temperature (T _C) | -40 °C to +85 °C |
| Storage temperature (T _{ST}) | -55 °C to +125 °C |
| Junction temperature (T _J) | 150 °C |

- For pulsed operation with duty cycle < 25%.
 - When amplifier is biased off (V_{REG} = 0 V).
 - Voltage on V_{REG} pin may not exceed the applied V_{CC} voltage.
- Performance is guaranteed only under the conditions listed in the specifications table and is not guaranteed under the full range(s) described by the Absolute Maximum specifications. Exceeding any of the absolute maximum/minimum specifications may result in permanent damage to the device and will void the warranty. Each absolute maximum rating listed is an individual parameter. Biasing and driving the amplifier with more than one absolute maximum rating listed may result in permanent damage to the device. Exposure to maximum rating conditions for extended periods may reduce device reliability.

CAUTION: Although this device is designed to be as robust as possible, ESD (Electrostatic Discharge) can damage this device. This device must be protected at all times from ESD. Static charges may easily produce potentials of several kilovolts on the human body or equipment, which can discharge without detection. Industry-standard ESD precautions must be employed at all times.

Typical Performance Data

V_{CC} (V_D) = 3.5 V, V_{REG} = 2.75 V, Frequency = 815 MHz, T_C = 25 °C, unless otherwise specified.

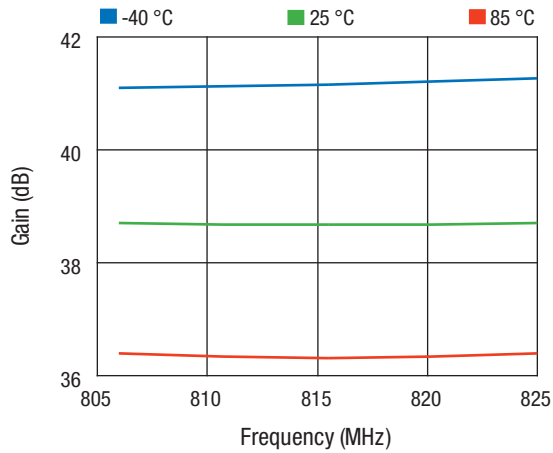

Gain vs. Frequency Across Temperature

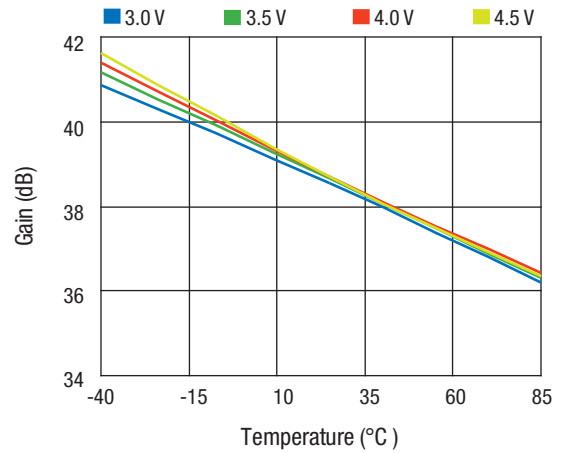

Gain vs. Temperature Across V_{CC}

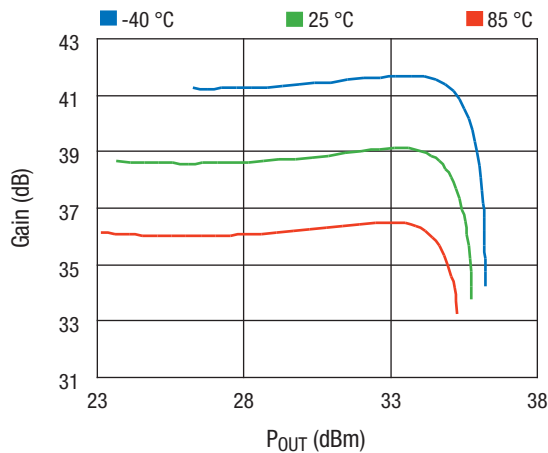

Gain vs. P_{OUT} Across Temperature

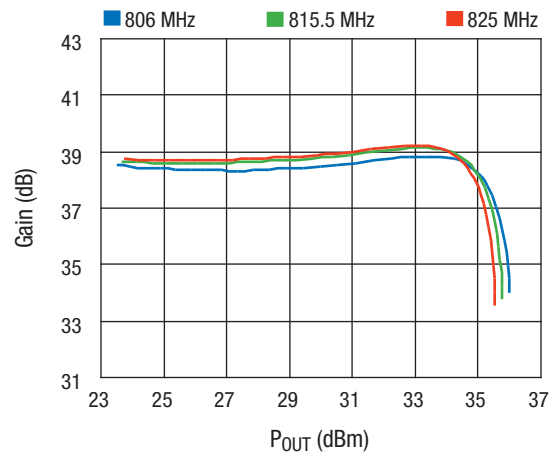

Gain vs. P_{OUT} Across Frequency

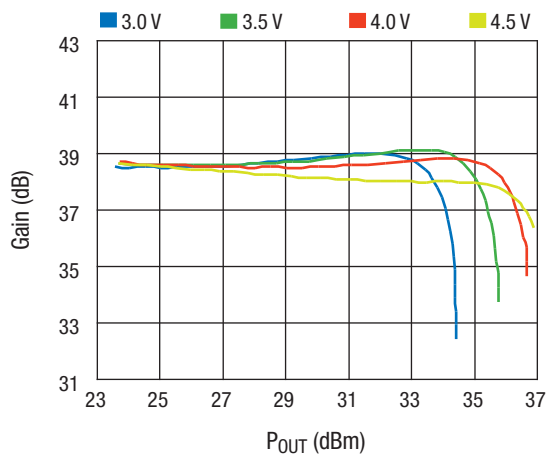

Gain vs. P_{OUT} Across V_{CC}

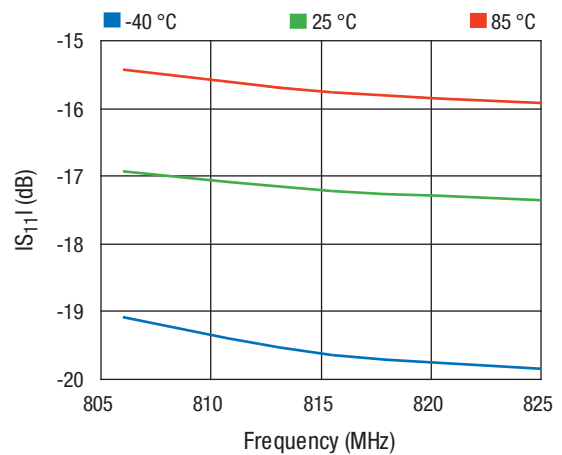

IS_{11I} vs. Frequency Across Temperature

Typical Performance Data

$V_{CC} (V_D) = 3.5 V$, $V_{REG} = 2.75 V$, Frequency = 815 MHz, $T_C = 25^\circ C$, unless otherwise specified.

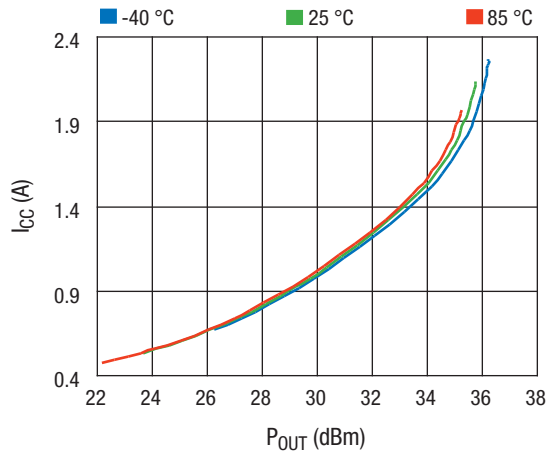

I_{CC} vs. P_{OUT} Across Temperature

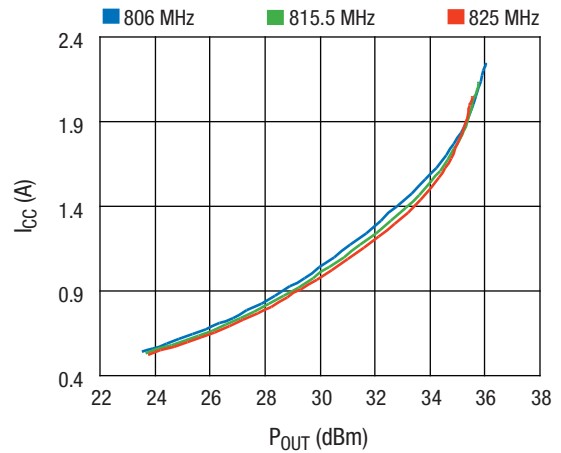

I_{CC} vs. P_{OUT} Across Frequency

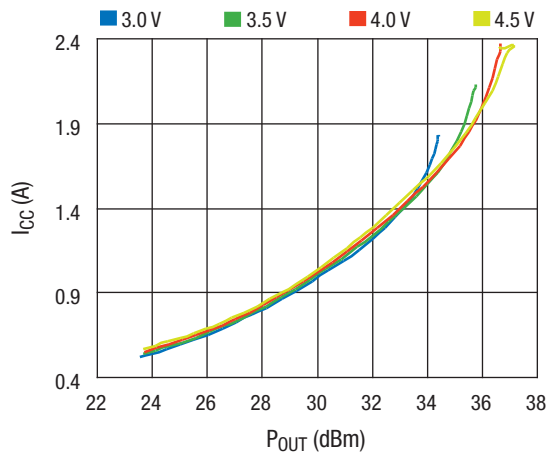

I_{CC} vs. P_{OUT} Across V_{CC}

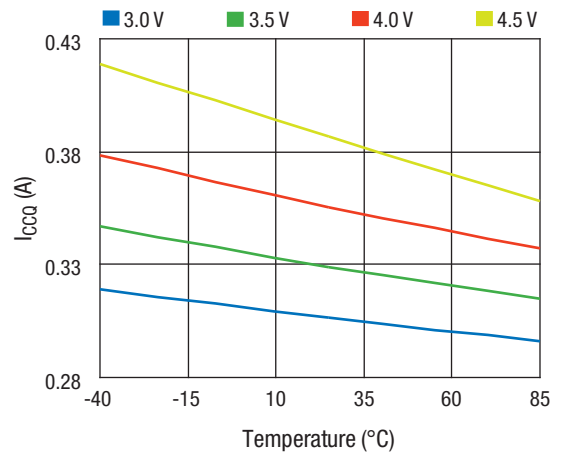

I_{CCQ} vs. Temperature Across V_{CC}

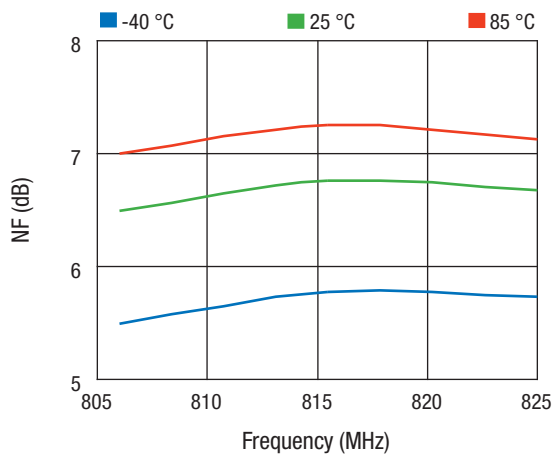

NF vs. Frequency Across Temperature

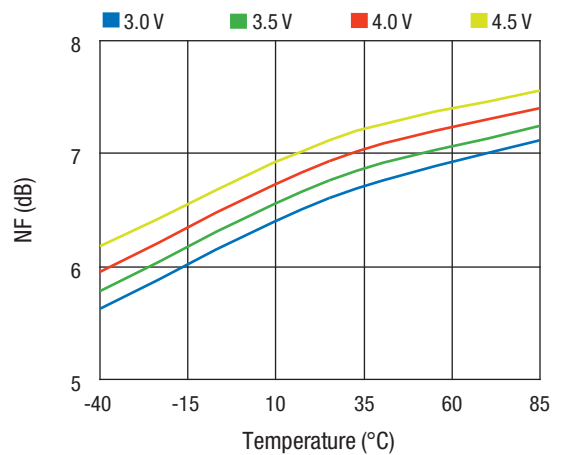

NF vs. Temperature Across V_{CC}

Typical Performance Data

V_{CC} (V_D) = 3.5 V, V_{REG} = 2.75 V, Frequency = 815 MHz, T_C = 25 °C, unless otherwise specified.

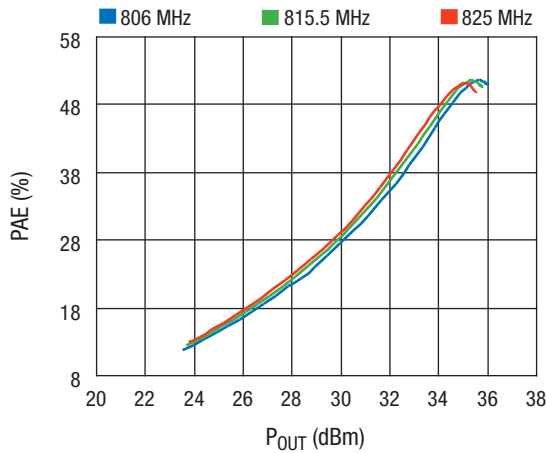

PAE vs. P_{OUT} Across Frequency

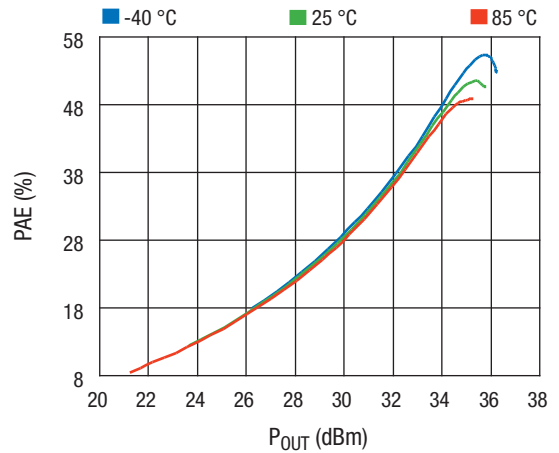

PAE vs. P_{OUT} Across Temperature

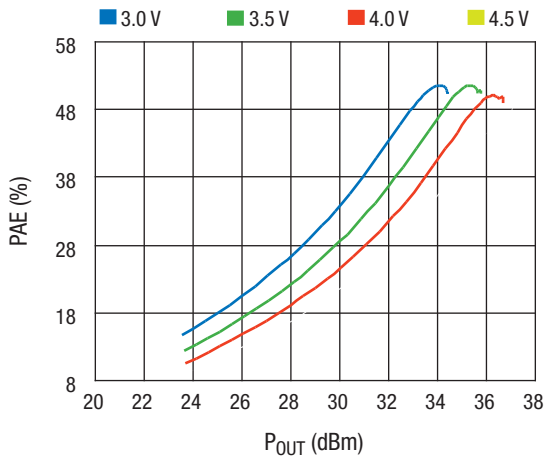

PAE vs. P_{OUT} Across V_{CC}

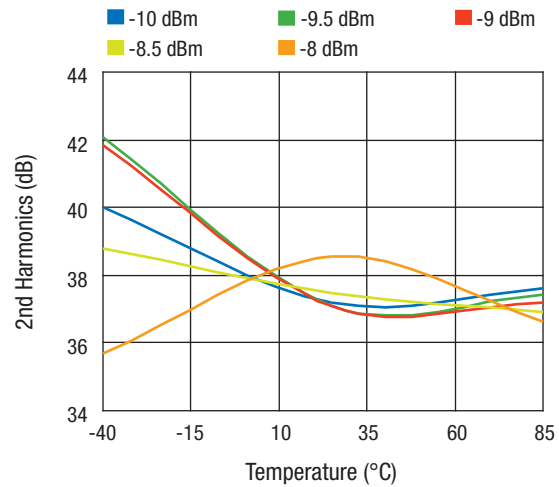

2nd Harmonics vs. Temperature Across P_{IN}

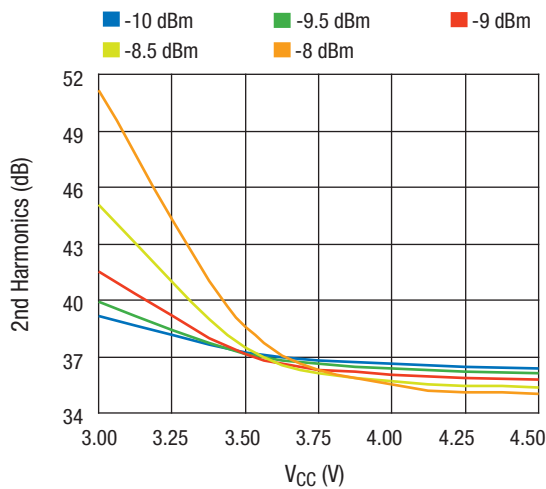

2nd Harmonics vs. V_{CC} Across P_{IN}

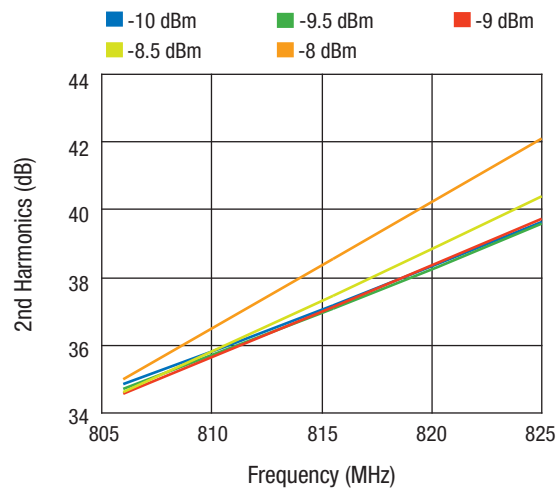

2nd Harmonics vs. Frequency Across P_{IN}

Typical Performance Data

$V_{CC} (V_D) = 3.5 V$, $V_{REG} = 2.75 V$, Frequency = 815 MHz, $T_C = 25 ^\circ C$, unless otherwise specified.

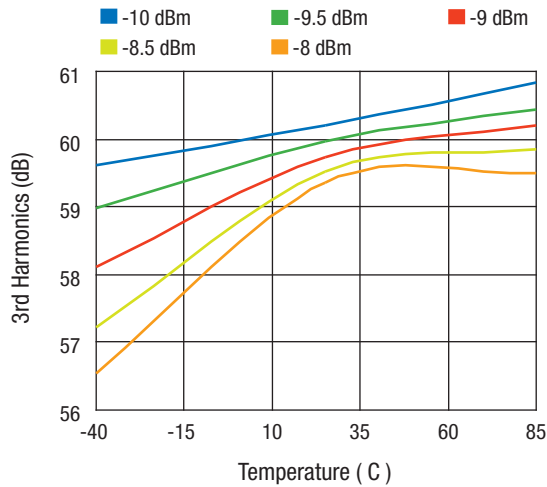

3rd Harmonics vs. Temperature Across P_{IN}

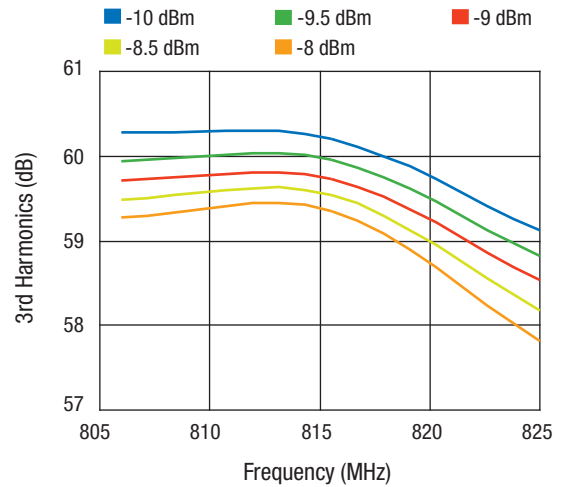

3rd Harmonics vs. Frequency Across P_{IN}

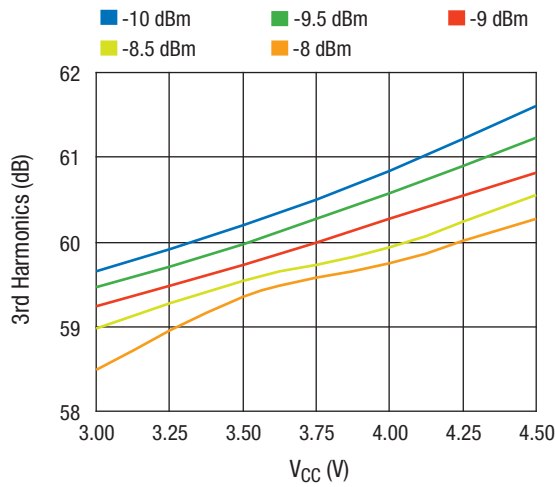

3rd Harmonics vs. V_{CC} Across P_{IN}

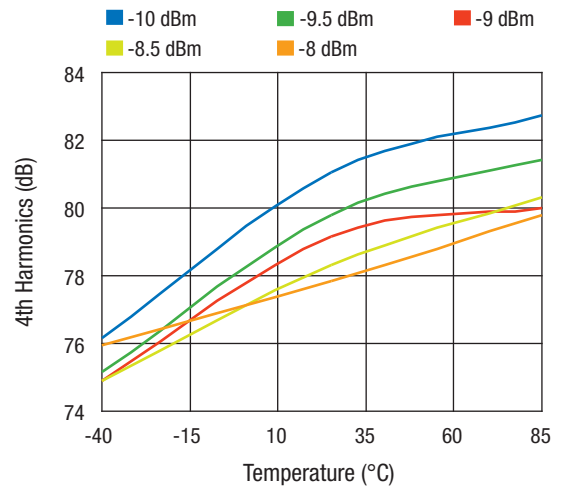

4th Harmonics vs. Temperature Across P_{IN}

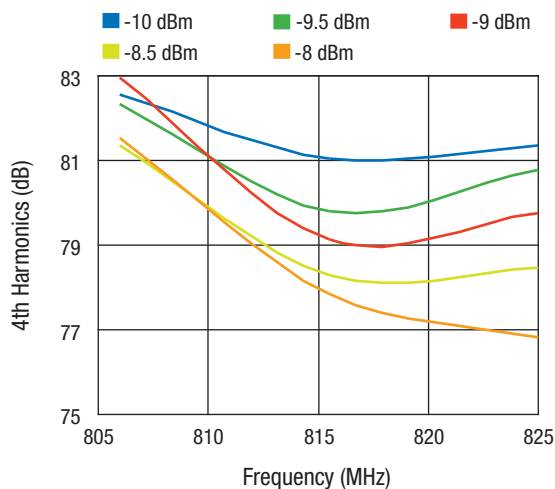

4th Harmonics vs. Frequency Across P_{IN}

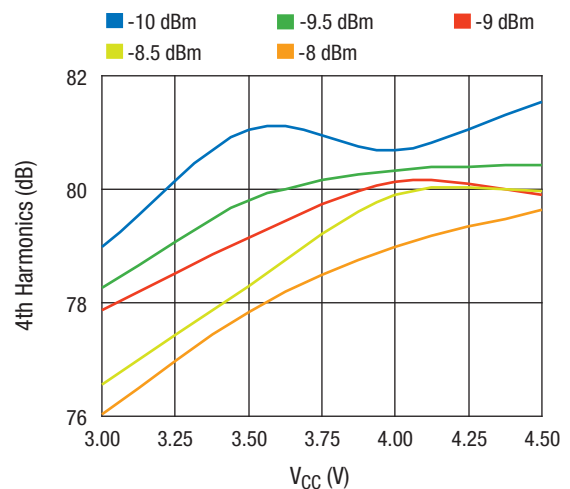

4th Harmonics vs. V_{CC} Across P_{IN}

Typical Performance Data

$V_{CC} (V_D) = 3.5 V$, $V_{REG} = 2.75 V$, Frequency = 815 MHz, $T_C = 25^\circ C$, unless otherwise specified.

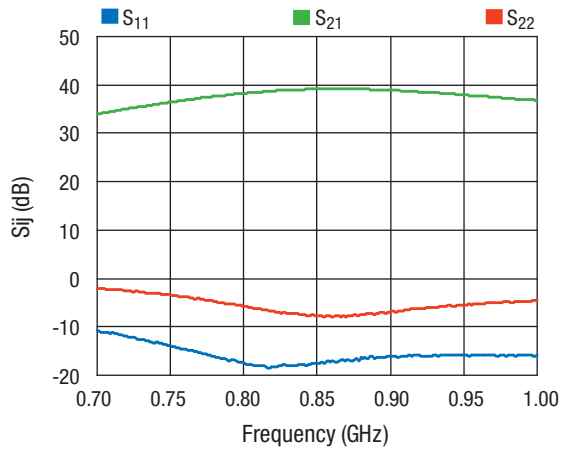

S-Parameters vs. Frequency

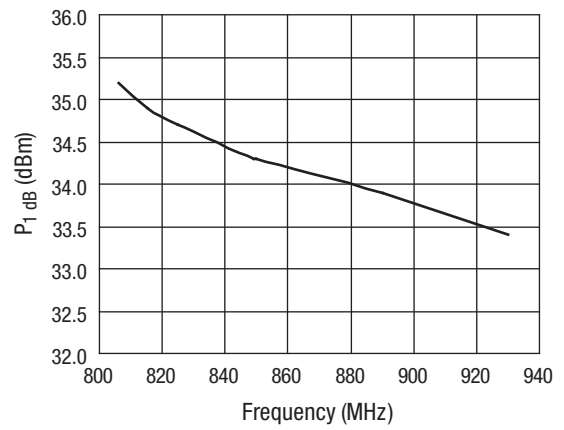

P₁ dB vs. Frequency

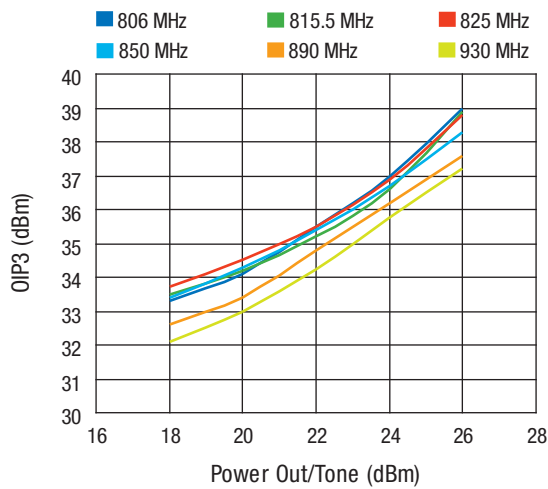

**OIP₃ vs. P_{OUT}/Tone Across Frequency
Tone Spacing = 1 MHz**

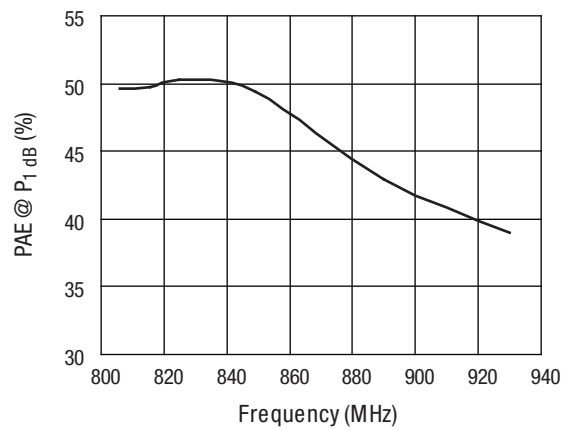

PAE @ P₁ dB vs. Frequency

Application Circuit Notes

Center Ground. It is extremely important that the device paddle be sufficiently grounded for both thermal and stability reasons. Multiple small vias are acceptable and will work well under the device if solder migration is an issue.

V_{D2} (Pin 1). Supply voltage for output (final) stage collector bias (typically 3.5 V). Bypassing of V_{D2} is accomplished with C2 and C3 and should be placed in the approximate location shown on the Evaluation Board, but placement is not critical.

Ground (Pins 2, 3, 6, 11, 13, 16, 19, 20, 23–28). Attach all ground pins to the RF ground plane with the largest diameter and lowest inductance via that the layout will allow. Multiple small vias are also acceptable and will work well under the device if solder migration is an issue.

No Connect (Pins 4, 5, 9, 10, 14, 17, 18, 21). The pins are open and may or may not be connected to ground.

V_{D4} (Pin 7). Supply voltage for base bias circuitry to all stages (typically 3.5 V). Bypassing of V_{D4} is accomplished with C1 which should be placed in the approximate location shown on the Evaluation Board, but placement is not critical.

V_{REG} (Pin 8). V_{REG} is the regulated bias enable control voltage to the silicon CMOS controller, 0.0 V = Off, 2.75 V = On. Nominal “On” operating range is between 2.65 V_{DC} and 2.85 V_{DC}. V_{REG} set to 0 V_{DC} will force the amplifier into standby mode.

RF_IN (Pin 12). Amplifier RF Input Pin. Z₀ = 50 Ω. The module includes an onboard internal DC blocking capacitor. All impedance matching is provided internal to the module.

V_{D3} (Pin 15). Supply voltage for driver collector bias (typically 3.5V). Bypassing of V_{D3} is accomplished with C4 and C5 which should be placed in the approximate location shown on the Evaluation Board, but placement is not critical.

RF_OUT (Pin 22). Amplifier RF Output Pin. Z₀ = 50 Ω. The module includes an onboard internal DC blocking capacitor. All impedance matching is provided internally to the module.

Package and Handling Information

Since the device package is sensitive to moisture absorption, it is baked and vacuum packed before shipping. Instructions on the shipping container label regarding exposure to moisture after the container seal is broken must be followed. Otherwise, problems related to moisture absorption may occur when the part is subjected to high temperature during solder assembly.

Please refer to Skyworks’ solder reflow application note, available at www.skyworksinc.com, for instructions on mounting the SKY65146 to a printed circuit board.

Production quantities of this product are shipped in a standard tape and reel format. For packaging details, refer to the Skyworks Application Note, Tape and Reel, document number 101568.

Electrostatic Discharge (ESD) Sensitivity

The SKY65146 is a static-sensitive electronic device. Do not operate or store near strong electrostatic fields. Take proper ESD precautions.

Theory of Operation

The SKY65146 is a fully matched 3-stage GaAs HBT power amplifier module consisting of on-chip interstage matching circuits and bias circuitry. The input and output match is realized off-chip, but within the module package. The amplifier employs series feedback on the first and second stages to provide for high gain and stability and power of up to 4 W.

The module includes a silicon CMOS controller circuit to provide a regulated bias enable control, V_{REG} (0–2.75 V) for amplifier On/Off operation. In off operation, supply current is a few microamperes with V_{REG} = 0 V. The module operates with all positive DC voltages while maintaining high efficiency and good linearity. The nominal operating voltage is 3.5 V for maximum power, but can be operated at slightly lower voltages for other mobile applications.

Application Circuit

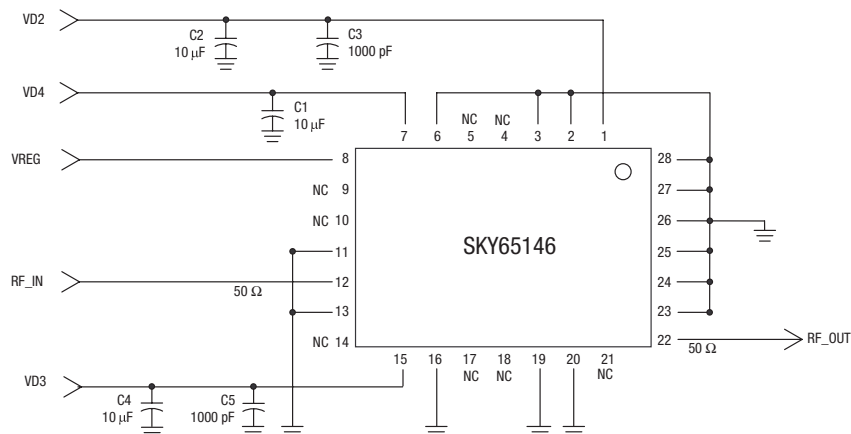

Pin Assignments

| Pin | Pin Name | Description |
|-----|------------------|--|
| 1 | V _{D2} | Supply voltage for output (final) stage collector bias (typically 3.5 V) |
| 2 | GND | Low inductance ground connection |
| 3 | GND | Low inductance ground connection |
| 4 | N/C | No connect |
| 5 | N/C | No connect |
| 6 | GND | Low inductance ground connection |
| 7 | V _{D4} | Supply voltage for base bias circuitry to all stages (typically 3.5 V) |
| 8 | V _{REG} | Regulated bias enable control voltage, 0.0 = Off, 2.75 V = On |
| 9 | N/C | No connect |
| 10 | N/C | No connect |
| 11 | GND | Low inductance ground connection |
| 12 | RFIN | 806–849 MHz RF input signal 50 Ω |
| 13 | GND | Low inductance ground connection |
| 14 | N/C | No connect |
| 15 | V _{D3} | Supply voltage for driver collector bias (typically 3.5 V) |
| 16 | GND | Low inductance ground connection |
| 17 | N/C | No connect |
| 18 | N/C | No connect |
| 19 | GND | Low inductance ground connection |
| 20 | GND | Low inductance ground connection |
| 21 | N/C | No connect |
| 22 | RFOUT | 806–849 MHz RF output signal 50 Ω |
| 23 | GND | Low inductance ground connection |
| 24 | GND | Low inductance ground connection |
| 25 | GND | Low inductance ground connection |
| 26 | GND | Low inductance ground connection |
| 27 | GND | Low inductance ground connection |
| 28 | GND | Low inductance ground connection |

Center attachment pad must have a low inductance and low thermal resistance connection to the customer's printed circuit board ground plane.

Evaluation Board

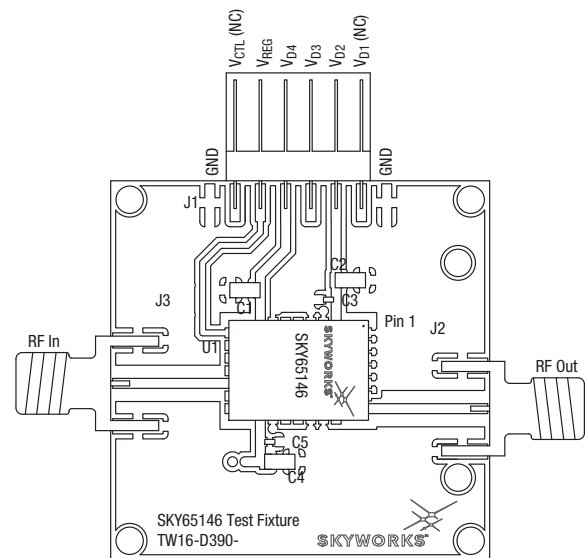

Recommended Solder Reflow Profiles

Refer to the [“Recommended Solder Reflow Profile”](#) Application Note.

Tape and Reel Information

Refer to the [“Discrete Devices and IC Switch/Attenuators Tape and Reel Package Orientation”](#) Application Note.

Evaluation Board Description

The Skyworks SKY65146 Evaluation Board is used to test the performance of the SKY65146 power amplifier module. The following design considerations are general in nature and must be followed regardless of final use or configuration.

1. Paths to ground should be made as short as possible.
2. The ground pad of the SKY65146 power amplifier module has special electrical and thermal grounding requirements. This pad is the main thermal conduit for heat dissipation. Since the circuit board acts as the heat sink, it must shunt as much heat as possible from the amplifiers. As such, design the connection to the ground pad to dissipate the maximum wattage produced to the circuit. Multiple vias to the grounding layer are required.

NOTE: Junction temperature (T_J) of the device increases with a poor connection to the slug and ground. This reduces the lifetime of the device.

Evaluation Board Test Procedure

- Step 1. Connect RF test equipment to Amplifier input/output SMA connectors.
- Step 2. Connect DC ground.
- Step 3. Connect all V_{CC} (V_D) lines to 3.5 V supply and V_{REG} to 2.75 V. Verify the I_{CQ} current is approximately 329 mA.
- Step 4. Apply RF signal data -30 dBm level and observe that the output level is approximately 8 dBm or the gain of the device is approximately 38 dB.

NOTE: It is important that the $VD2$, $VD3$, and $VD4$ voltage source be adjusted such that 3.5 V is measured at the board. The high collector currents will drop the collector voltage significantly if long leads are used. Adjust the bias voltage to compensate.

Bill of Material for Evaluation Board

| Part | ID | QTY | Size | Value | Units | Manufacturer | Product Number |
|------|----|-----|------|-------|---------|--------------|-------------------|
| 1 | C1 | 1 | 1206 | 10 | μ F | AVX | TAJA106M006R |
| 2 | C2 | 1 | 1206 | 10 | μ F | AVX | TAJA106M006R |
| 3 | C3 | 1 | 0402 | 1000 | pF | Murata | GRM155R71H102KA01 |
| 4 | C4 | 1 | 1206 | 10 | μ F | AVX | TAJA106M006R |
| 5 | C5 | 1 | 0402 | 1000 | pF | Murata | GRM155R71H102KA01 |

Evaluation Board Stack-Up

| Cross Section | Name | Thickness (mm) | Material | ϵ_r |
|---------------|------|----------------|-------------|--------------|
| | L1 | 0.025 | Cu | - |
| | Lam1 | 0.400 | Rogers 4003 | 3.38 |
| | L2 | 0.025 | Cu | - |
| | Lam2 | 0.600 | FR4 | 4.00 |
| | L3 | 0.025 | Cu | - |
| | Lam3 | 0.400 | FR4 | 4.00 |
| | L4 | 0.025 | Cu | - |

Branding Specifications

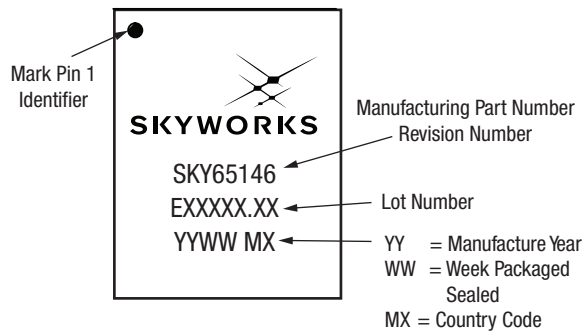

Package Outline

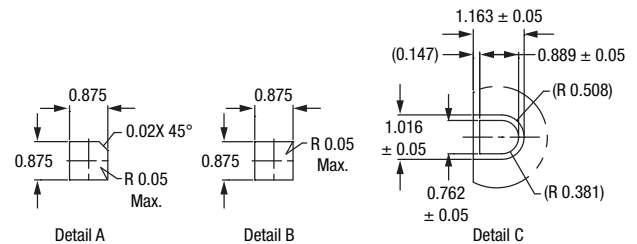
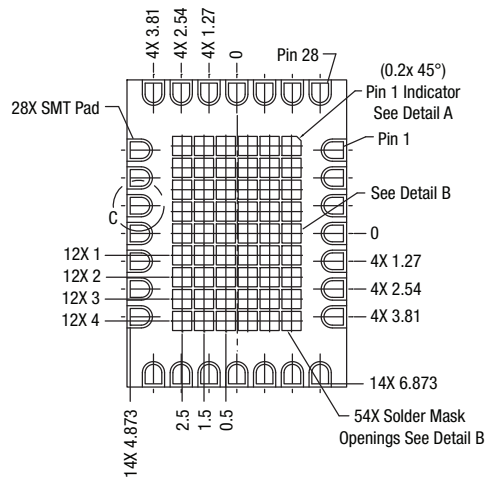
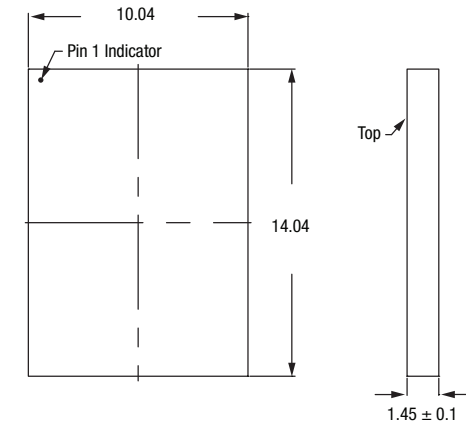

Units = mm.

Recommended Footprint

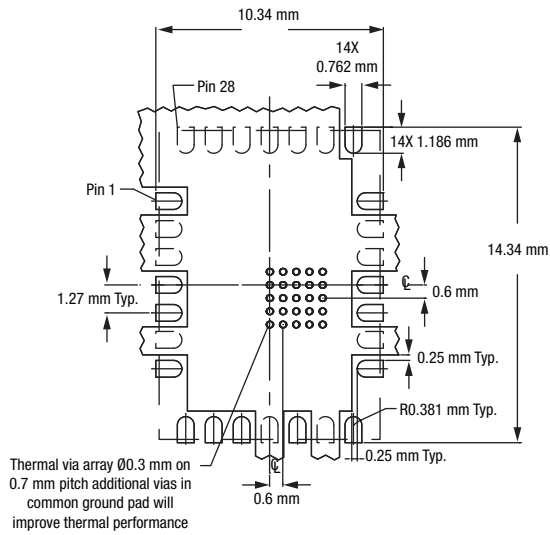

Thermal vias should be tented and filled with solder mask 30-35 µm copper plating recommended.

Solder Mask

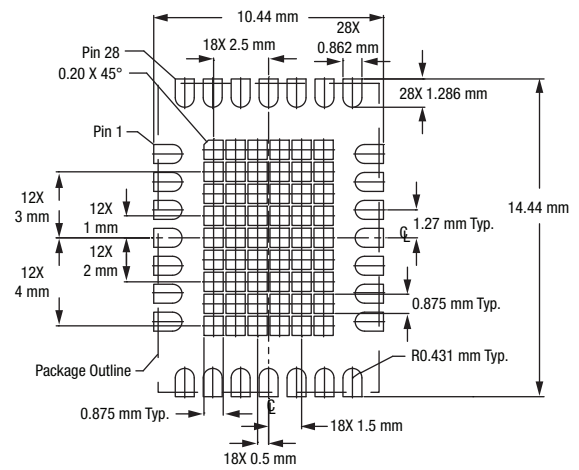

Stencil Pattern

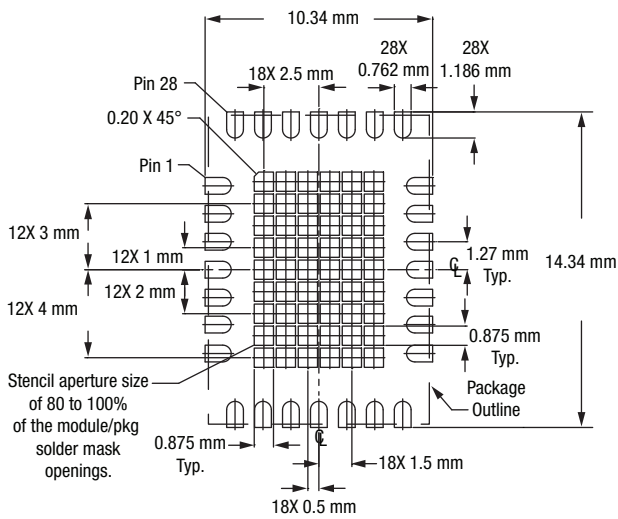

Ordering Information

| Model Name | Manufacturing Part Number | Evaluation Kit Part Number |
|---|-------------------------------|----------------------------|
| SKY65146: 3.5 V Broadband MCM Power Amplifier 806–849 MHz | SKY65146-21 (Pb-free package) | TW16-D390 |

Copyright © 2007, 2008, Skyworks Solutions, Inc. All Rights Reserved.

Information in this document is provided in connection with Skyworks Solutions, Inc. (“Skyworks”) products or services. These materials, including the information contained herein, are provided by Skyworks as a service to its customers and may be used for informational purposes only by the customer. Skyworks assumes no responsibility for errors or omissions in these materials or the information contained herein. Skyworks may change its documentation, products, services, specifications or product descriptions at any time, without notice. Skyworks makes no commitment to update the materials or information and shall have no responsibility whatsoever for conflicts, incompatibilities, or other difficulties arising from any future changes.

No license, whether express, implied, by estoppel or otherwise, is granted to any intellectual property rights by this document. Skyworks assumes no liability for any materials, products or information provided hereunder, including the sale, distribution, reproduction or use of Skyworks products, information or materials, except as may be provided in Skyworks Terms and Conditions of Sale.

THE MATERIALS, PRODUCTS AND INFORMATION ARE PROVIDED “AS IS” WITHOUT WARRANTY OF ANY KIND, WHETHER EXPRESS, IMPLIED, STATUTORY, OR OTHERWISE, INCLUDING FITNESS FOR A PARTICULAR PURPOSE OR USE, MERCHANTABILITY, PERFORMANCE, QUALITY OR NON-INFRINGEMENT OF ANY INTELLECTUAL PROPERTY RIGHT; ALL SUCH WARRANTIES ARE HEREBY EXPRESSLY DISCLAIMED. SKYWORKS DOES NOT WARRANT THE ACCURACY OR COMPLETENESS OF THE INFORMATION, TEXT, GRAPHICS OR OTHER ITEMS CONTAINED WITHIN THESE MATERIALS. SKYWORKS SHALL NOT BE LIABLE FOR ANY DAMAGES, INCLUDING BUT NOT LIMITED TO ANY SPECIAL, INDIRECT, INCIDENTAL, STATUTORY, OR CONSEQUENTIAL DAMAGES, INCLUDING WITHOUT LIMITATION, LOST REVENUES OR LOST PROFITS THAT MAY RESULT FROM THE USE OF THE MATERIALS OR INFORMATION, WHETHER OR NOT THE RECIPIENT OF MATERIALS HAS BEEN ADVISED OF THE POSSIBILITY OF SUCH DAMAGE.

Skyworks products are not intended for use in medical, lifesaving or life-sustaining applications, or other equipment in which the failure of the Skyworks products could lead to personal injury, death, physical or environmental damage. Skyworks customers using or selling Skyworks products for use in such applications do so at their own risk and agree to fully indemnify Skyworks for any damages resulting from such improper use or sale.

Customers are responsible for their products and applications using Skyworks products, which may deviate from published specifications as a result of design defects, errors, or operation of products outside of published parameters or design specifications. Customers should include design and operating safeguards to minimize these and other risks. Skyworks assumes no liability for applications assistance, customer product design, or damage to any equipment resulting from the use of Skyworks products outside of stated published specifications or parameters.

Skyworks, the Skyworks symbol, and “Breakthrough Simplicity” are trademarks or registered trademarks of Skyworks Solutions, Inc., in the United States and other countries. Third-party brands and names are for identification purposes only, and are the property of their respective owners. Additional information, including relevant terms and conditions, posted at www.skyworksinc.com, are incorporated by reference.