

DATA SHEET

SKY65080-70LF: 1500-2500 MHz Low Noise Power Amplifier Driver

Applications

- UHF television
- TETRA radios
- PCS, DCS, 2.5G, 3G handsets
- ISM band transmitters
- WCS fixed wireless
- 802.16 WiMAX
- 3GPP LTE

Features

- Wideband frequency range: 1500 to 2500 MHz
- Low Noise Figure: 2.3 dB
- High linearity: IIP3 = +25.5 dBm
- Output P1dB = +21 dBm
- High gain: 15 dB
- Single DC supply: +5 V
- On-chip bias circuit
- SOT-89 (4-pin, 2.4 x 4.5 mm) package (MSL1, 260 °C per JEDEC J-STD-020)

NEW

Skyworks offers lead (Pb)-free RoHS (Restriction of Hazardous Substances) compliant packaging.

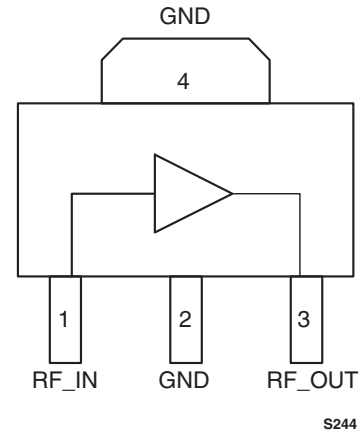

Figure 1. SKY65080-70LF Pinout – 4-Pin SOT Package (Top View)

Description

Skyworks SKY65080-70LF is a high performance, ultra-wideband Power Amplifier (PA) driver with superior output power, low noise, linearity, and efficiency. The device provides a 2.3 dB Noise Figure (NF) and an output power at 1 dB compression of +21 dBm, making the SKY65080-70LF ideal for use in the driver stage of infrastructure transmit chains.

The SKY65080-70LF uses low-cost Surface-Mount Technology (SMT) in the form of a 4-pin, 2.4 x 4.5 mm Small Outline Transistor (SOT) package. The device package and pinout are shown in Figure 1 and a functional block diagram is provided in Figure 2.

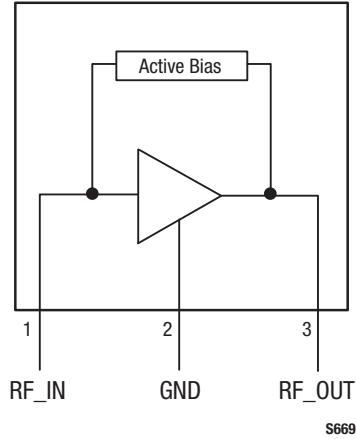

Figure 2. SKY65080-70LF Functional Block Diagram

Table 1. SKY65080-70LF Signal Descriptions

Pin #	Name	Description
1	RF_IN	RF input
2	GND	Ground
3	RF_OUT	RF output
4	GND	Ground

Technical Description

The SKY65080-70LF is a single stage, low-noise PA that operates with a single 5 V power supply connected through an RF choke (inductor L1) to the output signal (pin 3). The bias current is set by the on-chip active bias composed of current mirror and reference voltage transistors, which allow excellent gain tracking over temperature and voltage variations. The device is externally RF matched using surface mount components to facilitate operation over a frequency range of 1500 to 2500 MHz.

Electrical and Mechanical Specifications

Signal pin assignments and functional pin descriptions are described in Table 1. The absolute maximum ratings of the SKY65080-70LF are provided in Table 2. The recommended operating conditions are specified in Table 3 and electrical specifications are provided in Table 4.

Typical performance characteristics of the SKY65080-70LF are illustrated in Figures 3 through 10.

Table 2. SKY65080-70LF Absolute Maximum Ratings

Parameter	Symbol	Min	Max	Units
Supply voltage	VCC		6	V
RF output power	P _{OUT}		+24	dBm
Supply current	I _{CC}		100	mA
Power dissipation	P _D		0.6	W
Operating case temperature	T _C	-40	+85	°C
Storage temperature	T _{ST}	-55	+125	°C
Junction temperature	T _J		+150	°C

Note: Exposure to maximum rating conditions for extended periods may reduce device reliability. There is no damage to device with only one parameter set at the limit and all other parameters set at or below their nominal values. Exceeding any of the limits listed here may result in permanent damage to the device.

CAUTION: Although this device is designed to be as robust as possible, Electrostatic Discharge (ESD) can damage this device. This device must be protected at all times from ESD. Static charges may easily produce potentials of several kilovolts on the human body or equipment, which can discharge without detection. Industry-standard ESD precautions should be used at all times.

Table 3. SKY65080-70LF Recommended Operating Conditions

Parameter	Symbol	Min	Typical	Max	Units
Supply voltage	VCC	4.75	5.0	5.5	V
Operating frequency	f	1500	1750	2500	MHz
Operating case temperature	T _J	-40	+25	+85	°C

Table 4. SKY65080-70LF Electrical Characteristics (Note 1)

(VCC = +5 V, T_C = 25 °C, f = 1850 MHz, Unless Otherwise Noted)

Parameter	Symbol	Test Conditions	Min	Typical	Max	Units
Frequency	f		1700	1850	2000	MHz
Small signal gain	G	P _{IN} = -15 dBm	14	15		dB
Input return loss	S ₁₁	P _{IN} = -15 dBm	10	11		dB
Output return loss	S ₂₂	P _{IN} = -15 dBm	10	11		dB
Output power @ 1 dB compression	OP1dB	CW		+21		dBm
Operating current @ OP1dB	I _{CC_OP1DB}			75	100	mA
Third order input intercept point	IIP3	P _{IN} /tone = -10 dBm, Δf = 1 MHz	+24.0	+25.5		dBm
Third order output intercept point	OIP3	P _{IN} /tone = -10 dBm, Δf = 1 MHz	+39.0	+40.5		dBm
Noise Figure	NF	Small signal		2.3	3.0	dB
Quiescent current	I _{CCQ}	No RF	40	66	90	mA

Note 1: Performance is guaranteed only under the conditions listed in this Table.

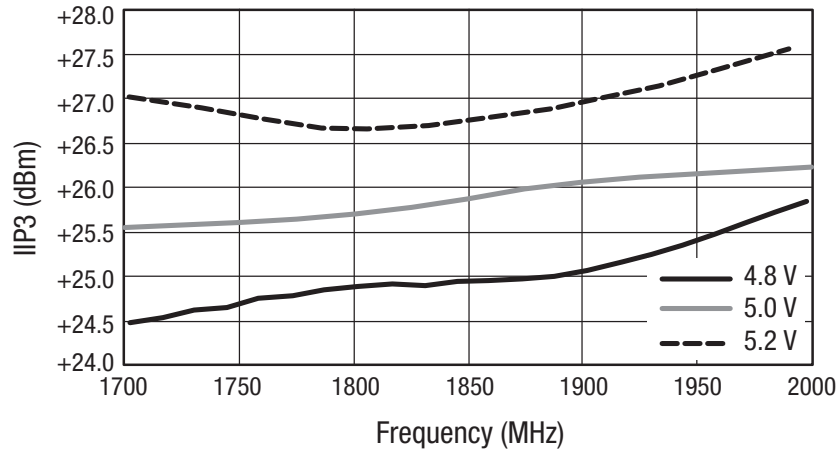

**Figure 3. Typical IIP3 vs Frequency Over VCC
(Input = -10 dBm CW)**

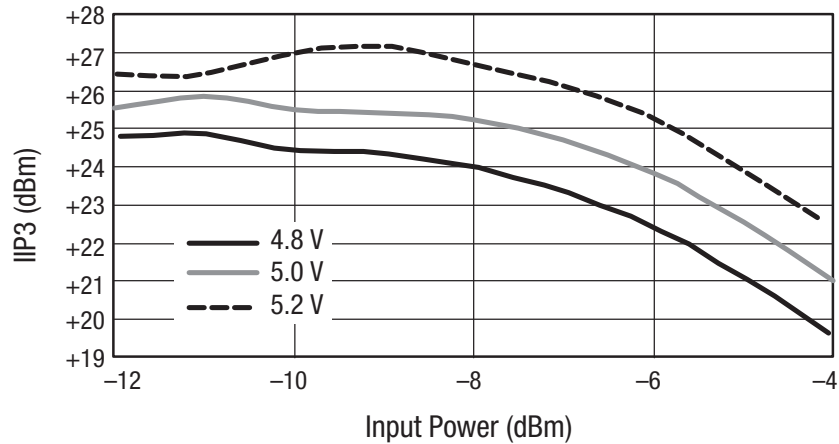

Figure 4. Typical IIP3 vs Input Power Over VCC @ 1700 MHz

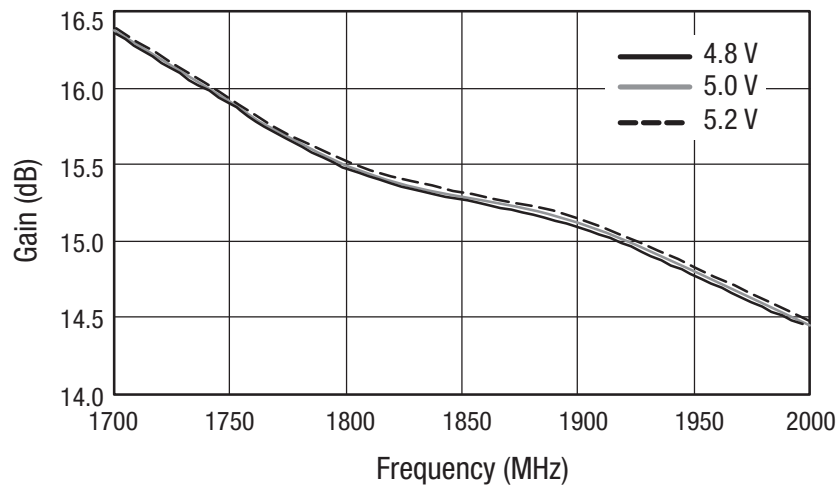

Figure 5. Gain vs Frequency Over VCC

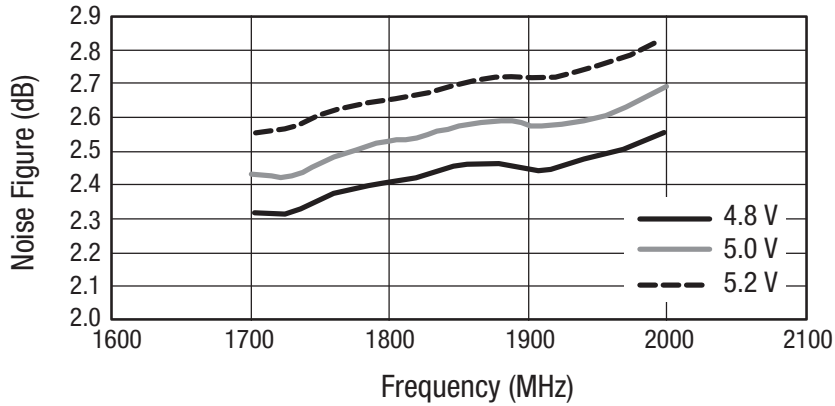

Figure 6. Noise Figure vs Frequency Over VCC

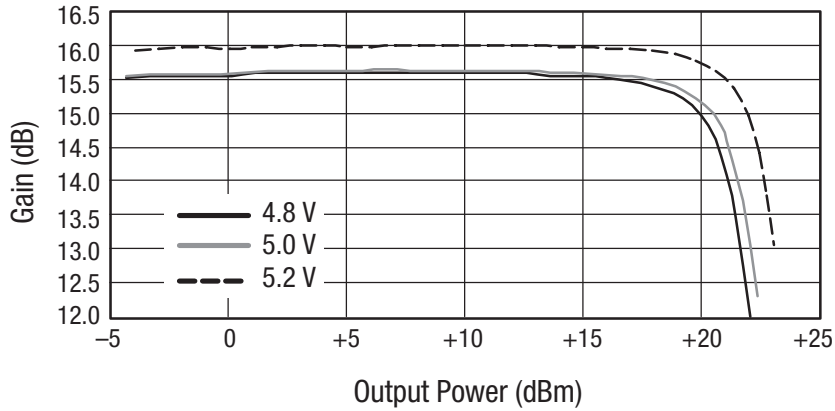

Figure 7. Typical Gain vs Output power Over VCC (CW @ 1800 MHz)

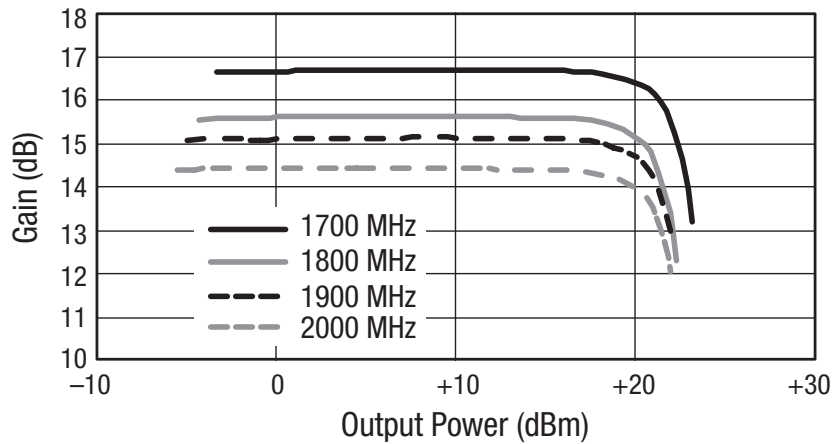

Figure 8. Gain vs Output Power Over Frequency

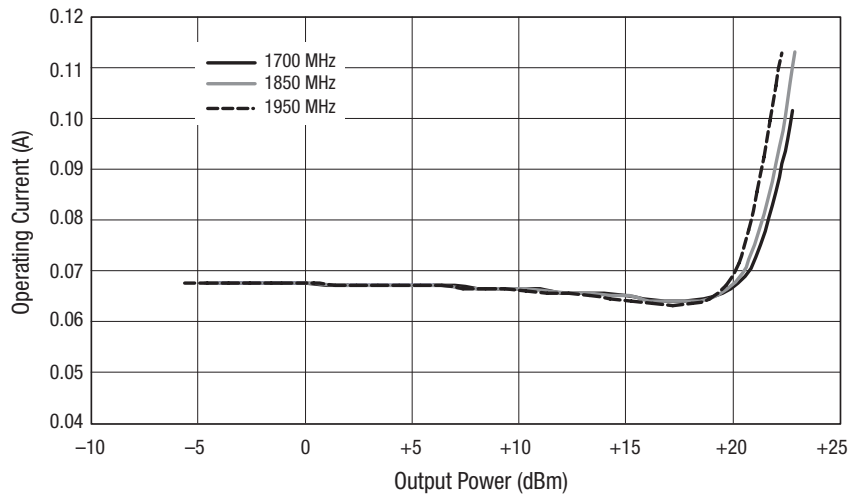

Figure 9. Operating Current vs Output Power Over Frequency

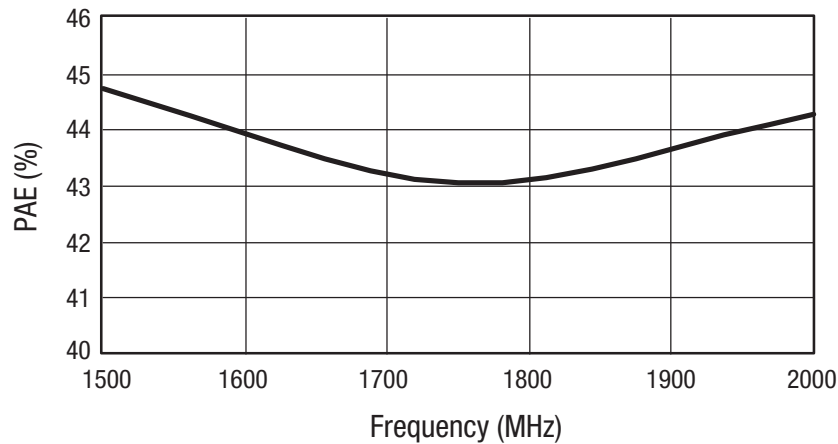

Figure 10. Power-Added Efficiency vs Frequency

Evaluation Board Description

The Skyworks SKY65080-70LF Evaluation Board is used to test the performance of the SKY65080-70LF PA driver. An assembly drawing for the Evaluation Board is shown in Figure 11 and the layer detail is provided in Figure 12.

Capacitors C7, C8, and C9 provide DC bias decoupling for VCC. Pins 1 and 3 are the RF input and output signals, respectively. External DC blocking is required on the input and output, but can be implemented as part of the RF matching circuit. Pin 2 and the package backside metal, pin 4, are ground pins that provide the DC and RF ground, respectively.

Circuit Design Configurations

The following design considerations are general in nature and must be followed regardless of final use or configuration.

1. Paths to ground should be made as short as possible.
2. The ground pad of the SKY65080-70LF power amplifier has special electrical and thermal grounding requirements. This pad is the main thermal conduit for heat dissipation. Since the circuit board acts as the heat sink, it must shunt as much heat as possible from the amplifier. As such, design the connection to the ground pad to dissipate the maximum wattage produced to the circuit board. Multiple vias to the grounding layer are required.

NOTE: Junction temperature (T_j) of the device increases with a poor connection to the slug and ground. This reduces the lifetime of the device.

A suggested matching circuit is shown in Figure 13 with component values for the SKY65080-70LF-11 package option listed in Table 5. Component values for the SKY65080-70LF-21 package option are shown in Table 6.

Testing Procedure

Use the following procedure to set up the SKY65080-70LF Evaluation Board for testing:

1. Connect a 5.0 V supply to VCC. If available, enable the current limiting function of the power supply to 100 mA.
2. Connect a signal generator to the RF signal input port. Set it to the desired RF frequency at a power level of -15 dBm or less to the Evaluation Board but do NOT enable the RF signal.
3. Connect a spectrum analyzer to the RF signal output port.
4. Enable the power supply.
5. Enable the RF signal.
6. Take measurements.

CAUTION: *If any of the output signals exceed the rated maximum values, the SKY65080-70LF Evaluation Board can be permanently damaged.*

Package and Handling Information

Since the device package is sensitive to moisture absorption, it is baked and vacuum packed before shipping. Instructions on the shipping container label regarding exposure to moisture after the container seal is broken must be followed. Otherwise, problems related to moisture absorption may occur when the part is subjected to high temperature during solder assembly.

The SKY65080-70LF is rated to Moisture Sensitivity Level 1 (MSL1) at 260 °C. It can be used for lead or lead-free soldering.

Care must be taken when attaching this product, whether it is done manually or in a production solder reflow environment. Production quantities of this product are shipped in a standard tape and reel format. For packaging details, refer to the Skyworks Application Note *Tape and Reel*, document number 101568.

Package Dimensions

Package dimensions for the 4-pin SOT-89 are shown in Figure 14, and tape and reel dimensions are provided in Figure 15.

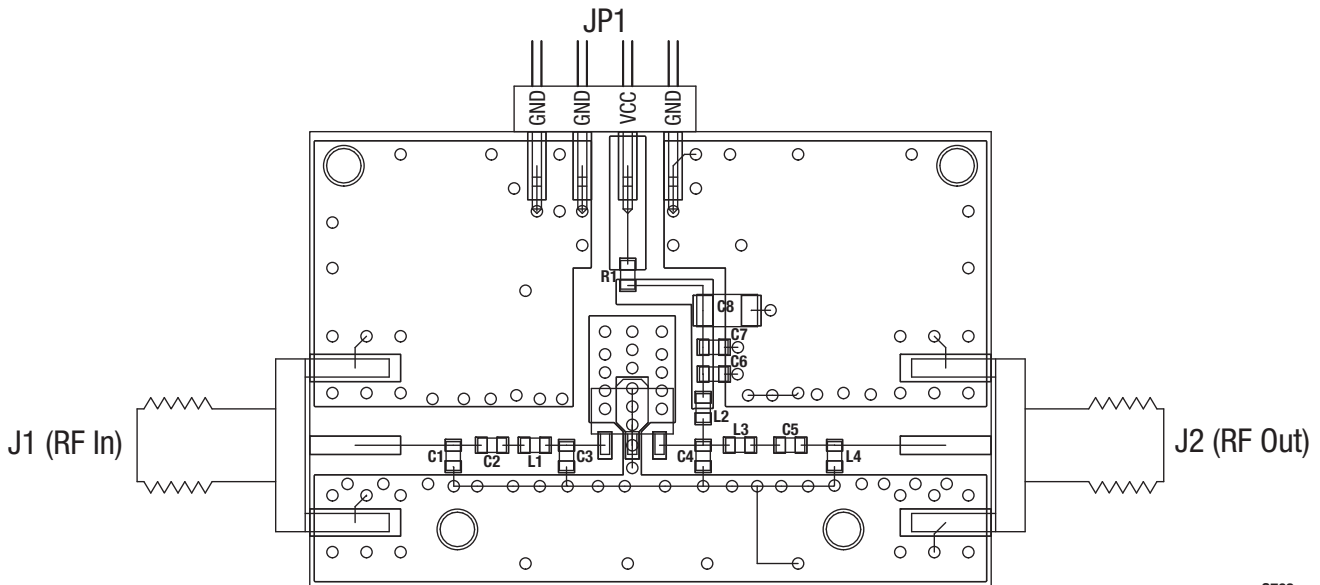

S708

Figure 11. Evaluation Board Assembly Drawing

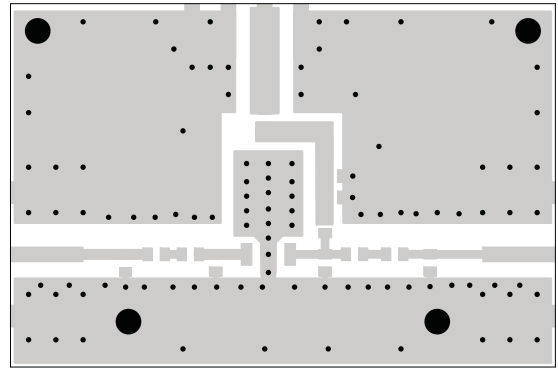

Layer 1: Top - Metal

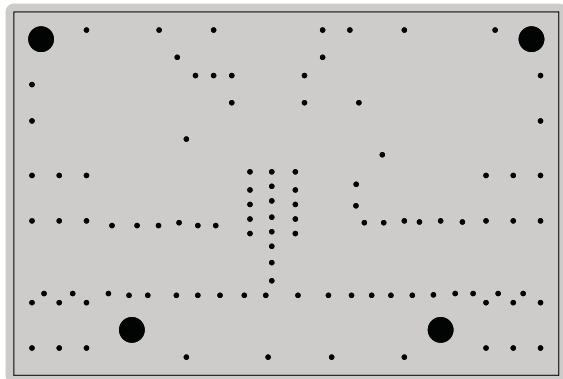

Layer 2: Ground

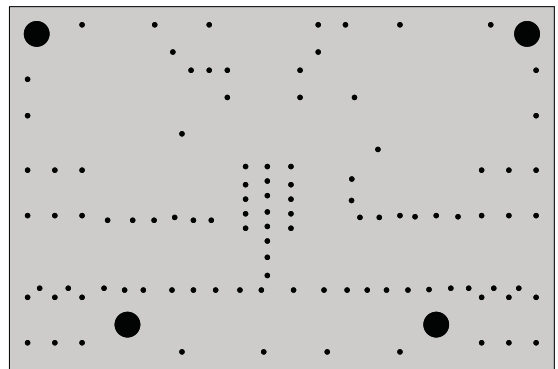

Layer 3: Ground

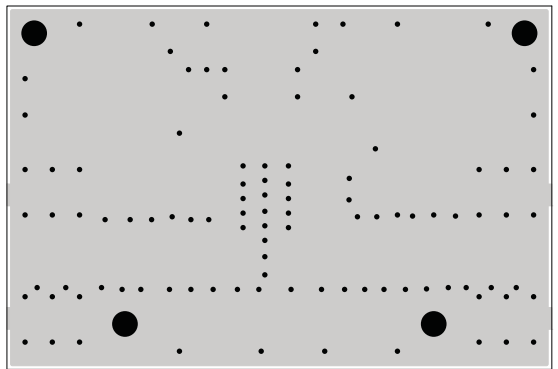

Layer 4: Solid Ground Plane

S1699

Figure 12. Evaluation Board Layer Detail

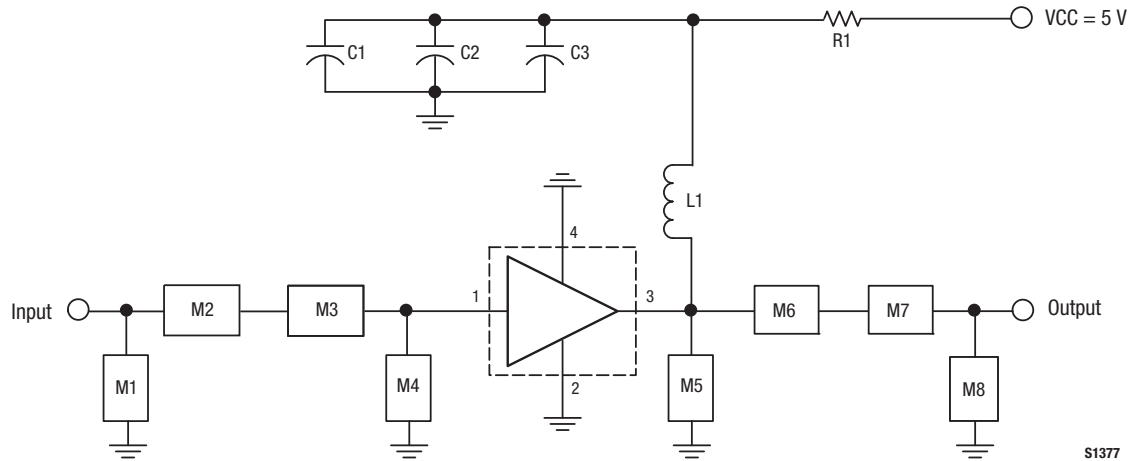
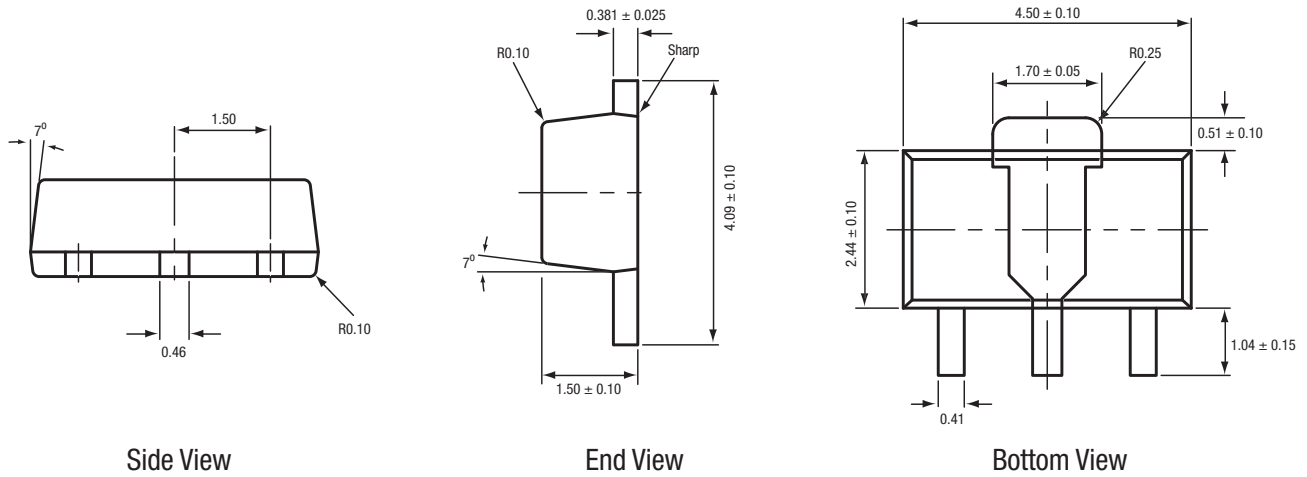

Figure 13. SKY65080-70LF Evaluation Board Schematic (1700 MHz to 2000 MHz, IIP3 Matched)

Table 5. SKY65080-70LF (SOT-89 Package) Evaluation Board Bill of Materials

Component	Size	Value	Vendor	Part Number
C1	0805	10 μ F	Panasonic	ECJ3YB0J106K
C2	0603	2.7 pF	Johanson	500R14N2R7DV6S-AA
C3	0603	DNI	–	–
L1	0603	4.7 nH	Taiyo-Yuden	HK1608RN7S-T
M1	0603	DNI	–	–
M2	0603	3.6 pF	Johanson	251R14S3R6BV4SX
M3	0603	2.2 nH	Johanson	L-14C2N2SV4SX
M4	0603	1.8 pF	Murata	GRM39C0G1R8D050BK
M5	0603	DNI	–	–
M6	0603	1.5 nH	Johanson	L-14C1N5SV4SX
M7	0603	33 pF	Johanson	500R14N330JV4T
M8	0603	DNI	–	–
R1	0603	0 Ω	Kamaya	RMC1/16-00JTP



All measurements are in millimeters

S253

Figure 14. SKY65080-70LF (4-Pin SOT-89) Package Dimensions

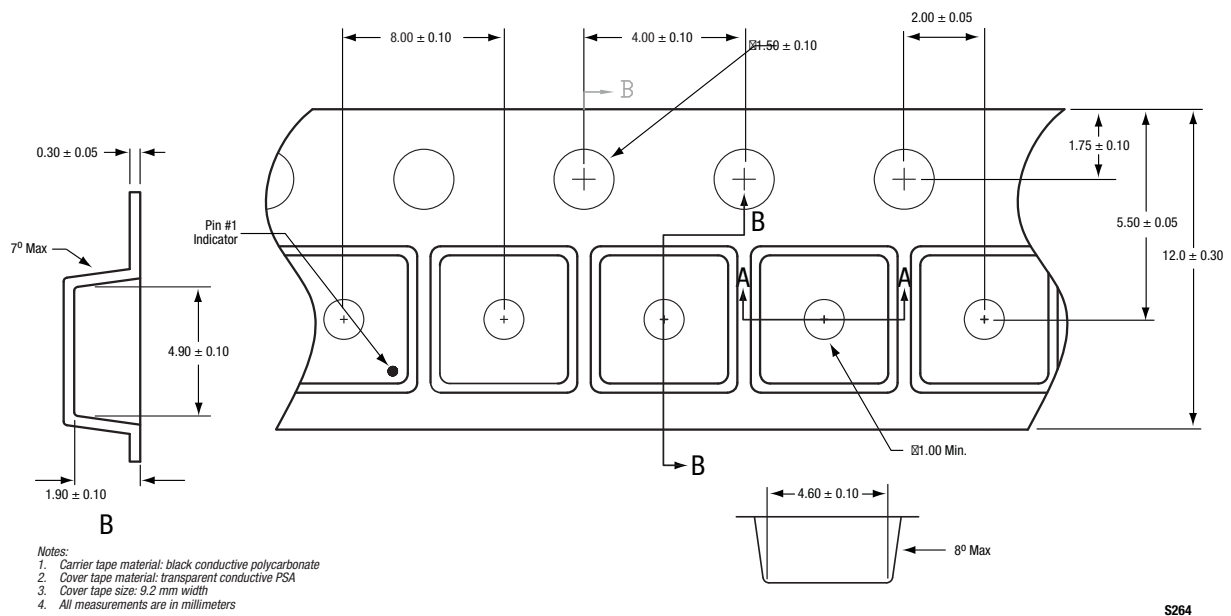

S264

Figure 15. SKY65080-70LF Tape and Reel Dimensions

Ordering Information

Model Name	Ordering Part Number	Evaluation Kit Part Number
SKY65080-70LF Low Noise PA Driver	SKY65080-70LF	TW18-D210

Copyright © 2009, 2010 Skyworks Solutions, Inc. All Rights Reserved.

Information in this document is provided in connection with Skyworks Solutions, Inc. ("Skyworks") products or services. These materials, including the information contained herein, are provided by Skyworks as a service to its customers and may be used for informational purposes only by the customer. Skyworks assumes no responsibility for errors or omissions in these materials or the information contained herein. Skyworks may change its documentation, products, services, specifications or product descriptions at any time, without notice. Skyworks makes no commitment to update the materials or information and shall have no responsibility whatsoever for conflicts, incompatibilities, or other difficulties arising from any future changes.

No license, whether express, implied, by estoppel or otherwise, is granted to any intellectual property rights by this document. Skyworks assumes no liability for any materials, products or information provided hereunder, including the sale, distribution, reproduction or use of Skyworks products, information or materials, except as may be provided in Skyworks Terms and Conditions of Sale.

THE MATERIALS, PRODUCTS AND INFORMATION ARE PROVIDED "AS IS" WITHOUT WARRANTY OF ANY KIND, WHETHER EXPRESS, IMPLIED, STATUTORY, OR OTHERWISE, INCLUDING FITNESS FOR A PARTICULAR PURPOSE OR USE, MERCHANTABILITY, PERFORMANCE, QUALITY OR NON-INFRINGEMENT OF ANY INTELLECTUAL PROPERTY RIGHT; ALL SUCH WARRANTIES ARE HEREBY EXPRESSLY DISCLAIMED. SKYWORKS DOES NOT WARRANT THE ACCURACY OR COMPLETENESS OF THE INFORMATION, TEXT, GRAPHICS OR OTHER ITEMS CONTAINED WITHIN THESE MATERIALS. SKYWORKS SHALL NOT BE LIABLE FOR ANY DAMAGES, INCLUDING BUT NOT LIMITED TO ANY SPECIAL, INDIRECT, INCIDENTAL, STATUTORY, OR CONSEQUENTIAL DAMAGES, INCLUDING WITHOUT LIMITATION, LOST REVENUES OR LOST PROFITS THAT MAY RESULT FROM THE USE OF THE MATERIALS OR INFORMATION, WHETHER OR NOT THE RECIPIENT OF MATERIALS HAS BEEN ADVISED OF THE POSSIBILITY OF SUCH DAMAGE.

Skyworks products are not intended for use in medical, lifesaving or life-sustaining applications, or other equipment in which the failure of the Skyworks products could lead to personal injury, death, physical or environmental damage. Skyworks customers using or selling Skyworks products for use in such applications do so at their own risk and agree to fully indemnify Skyworks for any damages resulting from such improper use or sale.

Customers are responsible for their products and applications using Skyworks products, which may deviate from published specifications as a result of design defects, errors, or operation of products outside of published parameters or design specifications. Customers should include design and operating safeguards to minimize these and other risks. Skyworks assumes no liability for applications assistance, customer product design, or damage to any equipment resulting from the use of Skyworks products outside of stated published specifications or parameters.

Skyworks, the Skyworks symbol, and "Breakthrough Simplicity" are trademarks or registered trademarks of Skyworks Solutions, Inc., in the United States and other countries. Third-party brands and names are for identification purposes only, and are the property of their respective owners. Additional information, including relevant terms and conditions, posted at www.skyworksinc.com, are incorporated by reference.