

Applications

- IEEE802.11b DSSS WLAN
- IEEE802.11g OFDM WLAN
- IEEE802.11a OFDM WLAN
- IEEE802.11n WLAN
- Access Points, PCMCIA, PC cards

Features

- All RF ports matched to 50 Ω
- Integrated 2.4 GHz PA, 5 GHz PA, TX Filter, T/R switches and diplexers
- Integrated Power Detector for each TX Chain
- 21 dBm O/P Power, 802.11b, 11 Mbits, ACPR = 35 dBc
- 18 dBm @ 3.0 % EVM, 802.11g, 54 Mbits
- 16.5 dBm @ 3.0 % EVM, 802.11a, 54 Mbits
- Single supply voltage: 3.3 V \pm 10 %
- Lead free, Halogen free, RoHS compliant, MSL 3
- 5mm x 5mm x 1.0mm, LGA Package

Ordering Information

Part No.	Package	Remark
SE2548A	32 pin LGA	Samples
SE2548A-R	32 pin LGA	Tape and Reel
SE2548A-EK1	N/A	Evaluation kit

Product Description

The SE2548A is a complete 802.11a/b/g/n WLAN RF front-end module providing all the functionality of the power amplifiers, filtering, power detector, T/R switch, diplexers and associated matching. The SE2548A provides a complete 2.4 GHz and 5 GHz WLAN RF solution from the output of the transceiver to the antenna in an ultra compact form factor.

Designed for ease of use, all RF ports are matched to 50 Ω to simplify PCB layout and the interface to the transceiver RFIC. The SE2548A also includes a transmitter power detector for each band and transmit chain with 20 dB of dynamic range for each transmit chain. Each transmit chain has a separate digital enable control for transmitter power ramp on/off control. The power ramp rise/fall time is less than 0.7 μ sec.

The device also provides a notch filter from 3.260-3.267 GHz and 3.28-3.89 GHz prior to the input of each 2.4 GHz and 5 GHz power amplifiers, respectively.

The SE2548A packaged in 5mm x 5mm x 1.0mm, Halogen free, Lead free, ROHS compliant, MSL 3 LGA package.

Functional Block Diagram

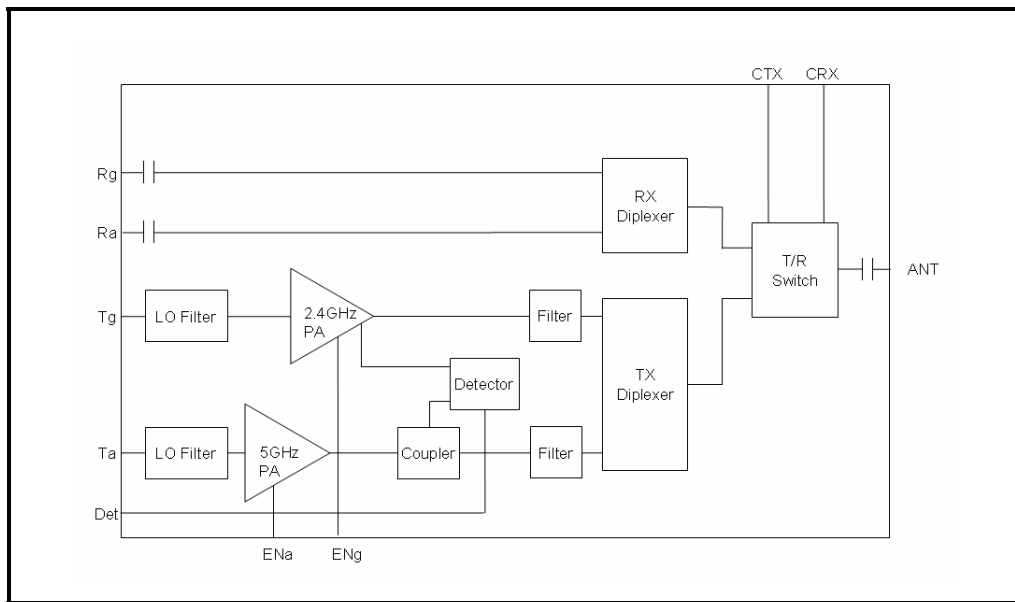

Figure 1: SE2548A Functional Block Diagram

<http://www.sige.com>

Email: sales@sige.com

Customer Service Locations:

North America:
1050 Morrison Drive, Suite 100
Ottawa ON K2H 8K7 Canada

Phone: +1 613 820 9244
Fax: +1 613 820 4933

Hong Kong
Phone: +852 3428 7222
Fax: +852 3579 5450

San Diego
Phone: +1 858 668 3541 (ext. 226)
Fax: +1 858 668 3546

United Kingdom
Phone: +44 1279 464217
Fax: +44 1279 464201

Product Preview

The datasheet contains information from the product concept specification. SiGe Semiconductor, Inc. reserves the right to change information at any time without notification.

Preliminary Information

The datasheet contains information from the design target specification. SiGe Semiconductor, Inc. reserves the right to change information at any time without notification.

Production testing may not include testing of all parameters.

Information furnished is believed to be accurate and reliable and is provided on an "as is" basis. SiGe Semiconductor, Inc. assumes no responsibility or liability for the direct or indirect consequences of use of such information nor for any infringement of patents or other rights of third parties, which may result from its use. No license or indemnity is granted by implication or otherwise under any patent or other intellectual property rights of SiGe Semiconductor, Inc. or third parties. Specifications mentioned in this publication are subject to change without notice. This publication supersedes and replaces all information previously supplied. SiGe Semiconductor, Inc. products are NOT authorized for use in implantation or life support applications or systems without express written approval from SiGe Semiconductor, Inc.

Copyright 2008 SiGe Semiconductor, Inc.
All Rights Reserved