

OKI Semiconductor

MSM7664

NTSC/PAL Digital Video Decoder

GENERAL DESCRIPTION

The MSM7664 is an LSI device that decodes NTSC or PAL analog video signals into YCbCr and RGB digital data based on ITU-RBT.601.

The device has built-in two channels of A/D converters and can accept composite video and S video signals for the input video signals. Composite video signals are converted to YCbCr and RGB digital data via the 2-dimensional Y/C separation circuit with an adaptive filter.

Analog video signals can be sampled by a clock at the pixel frequency or at twice the pixel frequency. A decimation filter is built-in for sampling at twice the pixel frequency.

Input signals are synchronized internally and high-speed locking for color burst is possible. Because a FIFO buffer is built into the output format circuit, jitter-free output can be obtained even for non-standard signals.

The MSM7664 is an improved version of the MSM7662, and is particularly superior in the picture quality and stabilization of synchronization in the PAL decoder as well as the stabilization of synchronization in the decoder under weak electric fields.

Further, although a part of the registers have been added, the electrical characteristics of both products are almost identical and their pin compatibility makes it possible to use the MSM7664 instead of the MSM7662.

APPLICATION EXAMPLES

Since the synchronization of input signals and high-speed locking for color burst are possible, the device is optimized for applications used by switching multiple cameras.

It is also used for various image processing applications because of jitter-free output data through a built-in FIFO buffer.

Even in the PAL mode, a YC separation characteristics equivalent to the NTSC mode has been achieved thereby making this LSI ideally suitable for PAL mode applications.

8-bit (YCbCr), 16-bit (8-bit (Y) + 8-bit (CbCr)), and 24-bit (RGB) output interfaces can be selected as an output mode so that various devices such as monitoring system, digital video memory, digital TV, video processing unit and video communication unit can be selected on the receiving side.

FEATURES (• new feature not found on MSM7662)

- Input analog signal
 - NTSC/PAL composite video signal or S-video signal
- Maximum 5 composite or 2 S-video + 2 composite analog inputs can be connected (switchable by external pins or internal registers)
- Built-in clamp circuits and video amps
- Built-in 8-bit A/D converters (2 channels)
- 4 selectable output interfaces
 - ITU-RBT.656 (conditional)
 - 8-bit (YCbCr) : 8-bit (YCbCr) YCbCr = 4 : 2 : 2/YCbCr = 4 : 1 : 1 (limit)
 - 16-bit (YCbCr) : 8-bit (Y) + 8-bit (CbCr) YCbCr = 4 : 2 : 2/YCbCr = 4 : 1 : 1 (limit)
 - 24-bit RGB : 8-bit (R) + 8-bit (G) + 8-bit (B)
- High speed of burst locking has been realized.
- 2-dimensional Y/C separation using adaptive comb filter (this filter is bypassed for S-video signal input)
 - NTSC format: 3 lines or 2 lines, PAL format: 2 lines (adaptive transition method)
- Built-in vertical chrominance filter (straight output without using the filter is possible)
- Selectable data I/O signal synchronization
 - 4 synchronization modes: internal FIFO modes (FIFO-1, FIFO-2) and external field memory modes (FM-1, FM-2) are selectable (FIFO-1 is normally selected).
- Compatible pixel frequencies (normal/twice the pixel frequency)
 - 13.5 MHz (13.5/27 MHz) : NTSC/PAL ITU-RBT.601
 - 12.272727 MHz (12.272727/24.545454 MHz) : NTSC Square pixel
 - 14.31818 MHz (14.31818/28.63636 MHz) : NTSC 4fsc
 - 14.75 MHz (14.75/29.5 MHz) : PAL Square Pixel
- Recognition of data in the VBI period (closed caption, CGMS, WSS, macrovision AGC and pseudo pulse) and function of reading from I²C-bus (only for ITU-RBT.601 mode).
- Built-in AGC/ACC circuits, compatible with a wide range of input levels
 - Input level range: -8 dB to +3.5 dB (0.4 V to 1.5 V)
 - Switchable between AGC/MGC (fixed gain) and ACC/MCC (fixed gain)
- Decimation filter built into input stage, allows easy configuration of filter prior to A/D converter (when input at twice the pixel frequency)
- Automatic NTSC/PAL recognition (only for ITU-RBT.601)
- Sleep mode
- Hi-Z mode for output pins
- Multiplex signal recognition (closed caption)
 - During vertical blanking interval, data is output as 8-bit data.
- I²C-bus interface
- 3.3 V single power supply (I/O 5 V tolerance)
- Package:
 - 100-pin plastic TQFP (TQFP100-P-1414-0.50-K) (Product name: MSM7664TB)

BLOCK DIAGRAM

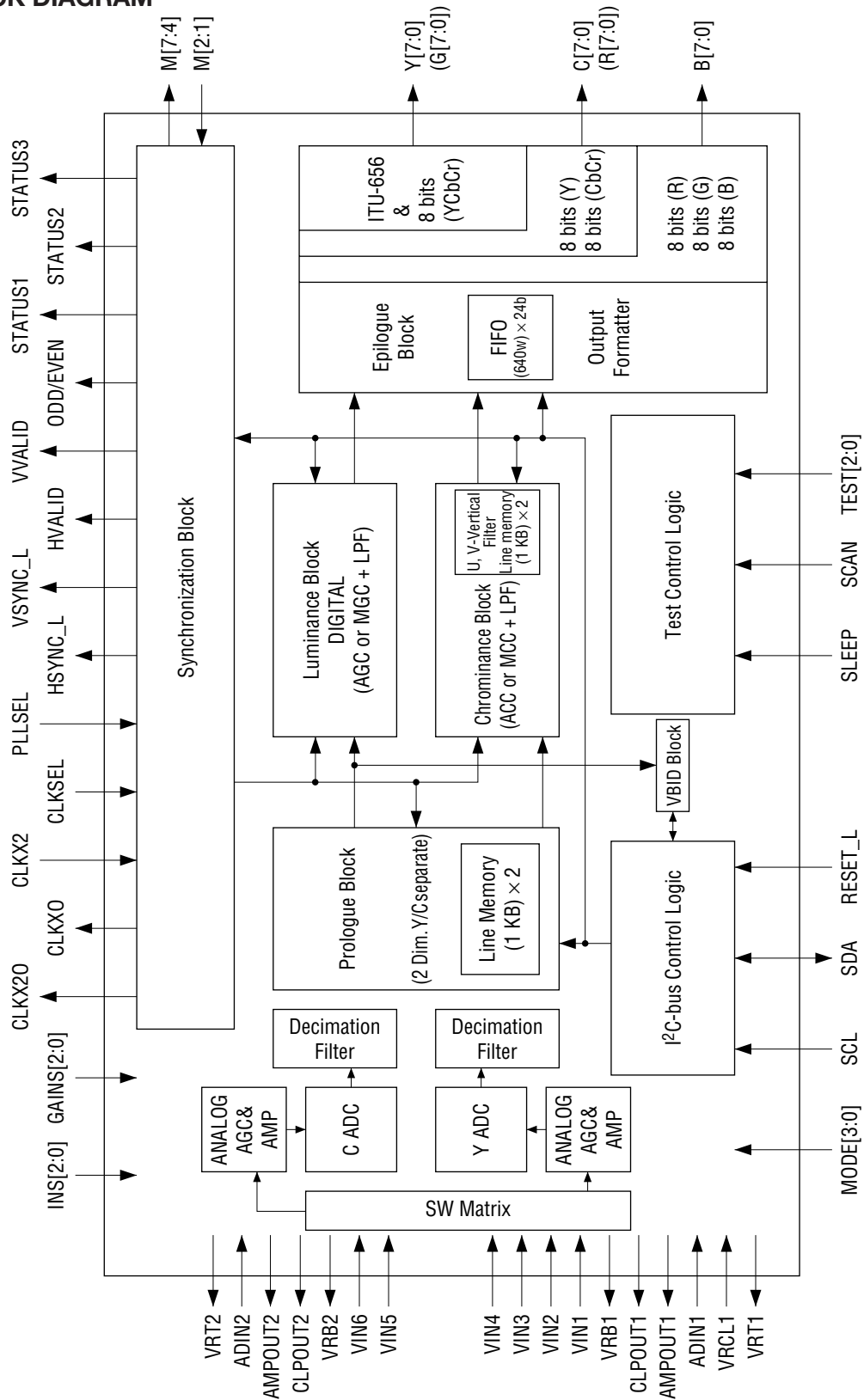

PIN CONFIGURATION (TOP VIEW)

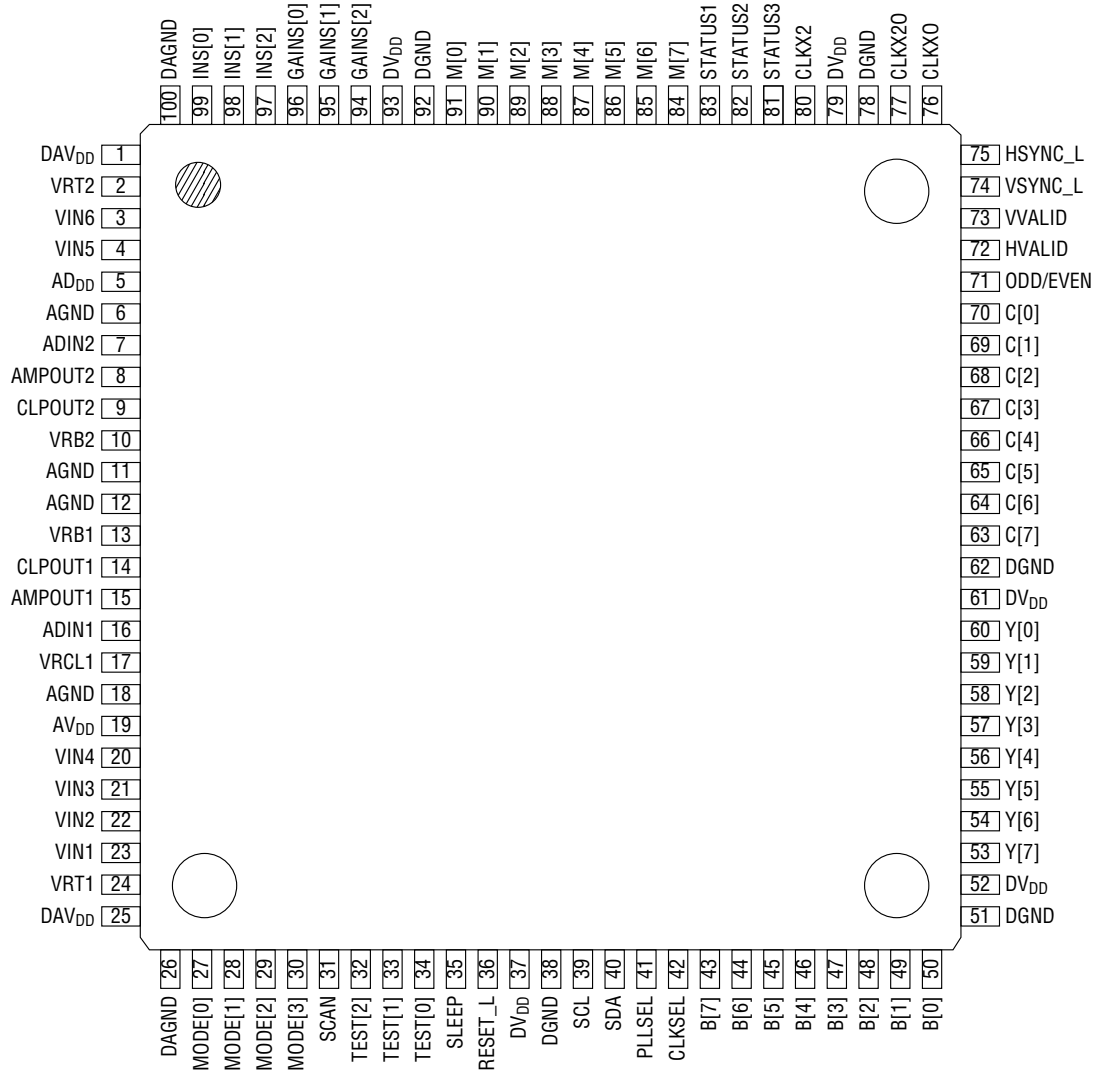

100-Pin Plastic TQFP

PIN DESCRIPTIONS

Pin	Symbol	Type	Description
1	DAV _{DD}	—	Digital power supply in A/D converter
2	VRT2	0	A/D converter reference voltage (high side) for S-video chroma signal
3	VIN6	I	S-video 2 chroma signal (C-2) input pin (leave open or connect to AGND when not used)
4	VIN5	I	Composite-5 or S-video 1 chroma signal (C-1) input pin (leave open or connect to AGND when not used)
5	AV _{DD}	—	Analog power supply
6	AGND	—	Analog ground
7	ADIN2	I	A/D converter input pin for S-video chroma signal
8	AMP _{OUT2}	0	S-video chroma signal amp output
9	CLP _{OUT2}	0	S-video chroma signal clamp voltage output
10	VRB2	0	A/D converter reference voltage (low side) for S-video chroma signal
11	AGND	—	Analog ground
12	AGND	—	Analog ground
13	VRB1	I	A/D converter reference voltage (low side) for composite/S-video (luminance signal)
14	CLP _{OUT1}	0	Composite/S-video (luminance signal) clamp voltage output
15	AMP _{OUT1}	0	Composite/S-video (luminance signal) amp output
16	ADIN1	I	A/D converter input pin for composite/S-video (luminance signal)
17	VRCL1	I	S-video (luminance signal) clamp voltage input
18	AGND	—	Analog ground
19	AV _{DD}	—	Analog power supply
20	VIN4	I	Composite-4 input (leave open or connect to AGND when not used)
21	VIN3	I	Composite-3 input (leave open or connect to AGND when not used)
22	VIN2	I	Composite-2 S-video 2 luminance signal (Y-2) input (leave open or connect to AGND when not used)
23	VIN1	I	Composite-1 S-video 1 luminance signal (Y-1) input (leave open or connect to AGND when not used)
24	VRT1	0	A/D converter reference voltage (high side) for composite/S-video (luminance signal)
25	DAV _{DD}	—	Digital power supply in A/D converter
26	DAGND	—	Digital ground in A/D converter

PIN DESCRIPTIONS (continued)

Pin	Symbol	Type	Description
27	MODE[0]	I	I/O switching input during external setting mode (pulled-down by internal resistors) Internal/external pins are switched by register MRA[0] The default of register MRA[0] is external pin mode. MODE [3:2] Output mode selection 00: ITU-RBT.656 (with 8-bit YCbCr SAV, EAV, blank processing) 01: 8-bit (YCbCr) 10: 16-bit (YCbCr) (ITU-RBT.601) 11: 24-bit RGB MODE [1] Input mode selection 0: NTSC 1: PAL Invalid if an ITU-RBT.601 signal is input while the register MRC[7] is set to automatic NTSC/PAL recognition. MODE [0] Input mode selection 0: ITU-RBT.601 1: Square Pixel NTSC 4fsc can be set by register MRA [3:1] only.
28	MODE[1]	I	
29	MODE[2]	I	
30	MODE[3]	I	
31	SCAN	I	Not used. Be left open or fixed at "0" (pulled down by internal resistor).
32	TEST[2]	I	Not used. Be left open or fixed at "0" (pulled down by internal resistor).
33	TEST[1]	I	Not used. Be left open or fixed at "0" (pulled down by internal resistor).
34	TEST[0]	I	Not used. Be left open or fixed at "0" (pulled down by internal resistor).
35	SLEEP	I	0: normal operation, 1: sleep operation
36	RESET_L	I	Reset input pin (active "L"). After powering ON, be sure to reset.
37	DV _{DD}	—	Digital power supply
38	DGND	—	Digital ground
39	SCL	I	I ² C-bus clock input
40	SDA	I/O	I ² C-bus data I/O pin
41	PLLSEL	I	Not used. Be left open or fixed at "0" (pulled down by internal resistor).
42	CLKSEL	I	Clock select input pin (pulled down by internal resistor). 0: double-speed input mode 1: normal input mode When a double-speed input mode is used, input a double frequency to system clock.
43 to 50	B[7] to B[0]	O	Data output B[7]: MSB, B[0]: LSB During RGB output mode: B 8-bit data output Other than RGB output mode: Hi-Z Output mode is set by pin 27 or 28, or register MRA [7:6].
51	DGND	—	Digital ground
52	DV _{DD}	—	Digital power supply

PIN DESCRIPTIONS (continued)

Pin	Symbol	Type	Description																		
53 to 60	Y[7] to Y[0]	0	Data output Y[7]: MSB, Y[0]: LSB During ITU-RBT.656 output mode: YCbCr 8-bit data output During 8-bit (YCbCr) output mode: YCbCr 8-bit data output During 16-bit (YCbCr) output mode: Y 8-bit data output During 24-bit RGB output mode: G 8-bit data output Output mode is set by pin 27 or 28, or register MRA [7:6].																		
61	DV _{DD}	—	Digital power supply																		
62	DGND	—	Digital ground																		
63 to 70	C[7] to C[0]	0	Data output C[7]: MSB, C[0]: LSB During ITU-RBT.656 output mode: Hi-Z During 8-bit (YCbCr) output mode: Hi-Z During 16-bit (YCbCr) output mode: CbCr 8-bit data output During 24-bit RGB output mode: R 8-bit data output Output mode is set by pin 27 or 28, or register MRA [7:6].																		
71	ODD/EVEN	0	Field display output If field is odd, "H" is output.																		
72	HVALID	0	Horizontal valid pixel timing output pin If section is valid, "H" is output.																		
73	VVALID	0	Vertical valid line timing output pin If section is valid, "H" is output.																		
74	VSYNC_L	0	Vertical sync signal (V sync) output pin																		
75	HSYNC_L	0	Horizontal sync signal (H sync) output pin																		
76	CLKX0	0	Pixel clock output During double-speed input mode (pin 42 = 0): One half of system clock frequency is output. During normal input mode (pin 42 = 1): The same frequency as system clock frequency is output.																		
77	CLKX20	0	System clock output System clock input is directly output.																		
78	DGND	—	Digital ground																		
79	DV _{DD}	—	Digital power supply																		
80	CLKX2	I	System clock input (selected by operation mode) <table border="1" style="margin-left: 20px;"> <thead> <tr> <th></th> <th>Normal input mode</th> <th>Double-speed input mode</th> </tr> </thead> <tbody> <tr> <td>NTSC ITU-RBT.601</td> <td>13.5 MHz</td> <td>27 MHz</td> </tr> <tr> <td>NTSC Square Pixel</td> <td>12.272727 MHz</td> <td>24.545454 MHz</td> </tr> <tr> <td>NTSC 4fsc</td> <td>14.31818 MHz</td> <td>28.63636 MHz</td> </tr> <tr> <td>PAL ITU-RBT.601</td> <td>13.5 MHz</td> <td>27 MHz</td> </tr> <tr> <td>PAL Square Pixel</td> <td>14.75 MHz</td> <td>29.5 MHz</td> </tr> </tbody> </table>		Normal input mode	Double-speed input mode	NTSC ITU-RBT.601	13.5 MHz	27 MHz	NTSC Square Pixel	12.272727 MHz	24.545454 MHz	NTSC 4fsc	14.31818 MHz	28.63636 MHz	PAL ITU-RBT.601	13.5 MHz	27 MHz	PAL Square Pixel	14.75 MHz	29.5 MHz
	Normal input mode	Double-speed input mode																			
NTSC ITU-RBT.601	13.5 MHz	27 MHz																			
NTSC Square Pixel	12.272727 MHz	24.545454 MHz																			
NTSC 4fsc	14.31818 MHz	28.63636 MHz																			
PAL ITU-RBT.601	13.5 MHz	27 MHz																			
PAL Square Pixel	14.75 MHz	29.5 MHz																			

PIN DESCRIPTIONS (continued)

Pin	Symbol	Type	Description
81	STATUS[3]	0	Status signal output Selected by internal register OMR[0] OMR[0]: 0 FIFO overflow detection (default) 0: non-detection, 1: detection OMR[0]: 1 CSYNC output
82	STATUS[2]	0	Status signal output Selected by internal register OMR[1] OMR[1]: 0 NTSC-PAL recognition (default) 0: NTSC, 1: PAL OMR[1]: 1 HLOCK sync detection output 0: non-detection, 1: detection
83	STATUS[1]	0	VBI interval multiplex signal detection output 0: non-detection, 1: detection
84	M[7]	0	Field memory control signal; RE output
85	M[6]	0	Field memory control signal; WE output
86	M[5]	0	Field memory control signal; RSTR output
87	M[4]	0	Field memory control signal; RSTW output
88	M[3]	0	Test output pin, normally "L" output
89	M[2]	I	I ² C-bus slave address select 0: 1000001X 1: 1000011X (no internal pull-up or pull-down resistor)
90	M[1]	I	Pin for setting by either external pin or internal register in order to select analog unit gain value (MGC) and video signal input pin. (no internal pull-up or pull-down resistor) 0: external pin mode Gain value setting: pins 94 to 96 (GAINS[2:0]) are used Input pin setting: pins 97 to 99 (INS[2:0]) are used 1: register mode Gain value setting: register ADC2[6:4] Input pin setting: register ADC1[2:0] Internal register setting is invalid when external pin mode is set.
91	M[0]	I	Selection of external field memory control signal output If field memory is not used, set M[0] to 0. 0: M[7:4] outputs are invalid 1: M[7:4] outputs are valid
92	DGND	—	Digital ground
93	DV _{DD}	—	Digital power supply

PIN DESCRIPTIONS (continued)

Pin	Symbol	Type	Description
94	GAINS[2]	I	Inputs for amplifier gain switch setting during external setting mode External pin mode: pin 90 (M[1]) = 0 (pulled down by internal resistors)
95	GAINS[1]	I	
96	GAINS[0]	I	
			GAINS[2:0] Gain value (x times)
			[000] 1.00
			[001] 1.35
			[010] 1.75
			[011] 2.30
			[100] 3.00
			[101] 3.80
			[110] 5.00
			[111] Undefined
97	INS[2]	I	Inputs for signal input pin switch setting during external setting mode External pin mode: pin 90 (M[1]) = 0 (pulled down by internal resistors)
98	INS[1]	I	
99	INS[0]	I	
			INS[2:0] Input pin
			[000] VIN1 (pin 23) Composite-1
			[001] VIN2 (pin 22) Composite-2
			[010] VIN3 (pin 21) Composite-3
			[011] VIN4 (pin 20) Composite-4
			[100] VIN5 (pin 4) Composite-5
			[101] VIN1 (pin 23) Y-1 VIN5 (pin 4) C-1
			[110] VIN2 (pin 22) Y-2 VIN6 (pin 3) C-2
			[111] Prohibited setting (ADC enters sleep state)
100	DAGND	—	Digital ground in A/D converter

ABSOLUTE MAXIMUM RATINGS

Parameter	Symbol	Condition	Rating	Unit
Power Supply Voltage	V_{DD}	$T_a = 25^{\circ}\text{C}$	-0.3 to +4.5	V
Input Voltage	V_I	$V_{DD} = 3.3\text{ V}$	-0.3 to +5.5	V
Power Consumption	P_W	—	1	W
Storage Temperature	T_{STG}	—	-55 to +150	$^{\circ}\text{C}$

RECOMMENDED OPERATING CONDITIONS

Parameter	Symbol	Condition	Min.	Typ.	Max.	Unit
Power Supply Voltage	V_{DD}	—	3.0	3.3	3.45	V
Power Supply Voltage	GND	—	—	0	—	V
Digital "H" Level Input Voltage	V_{IH1}	—	2.2	—	$V_{DD} (*2)$	V
	$V_{IH2} (*1)$	—	$0.8 \times V_{DD}$	—	$V_{DD} (*2)$	V
Digital "L" Level Input Voltage	V_{IL}	—	0	—	0.8	V
Analog Video Signal Input	V_{AIN}	SYNC tip to white peak level	0.8	—	1.1	V_{P-P}
Operating Temperature	T_a	—	0	—	60	$^{\circ}\text{C}$

*1: CLKSEL, SDA, CLKXO

*2: Since the inputs have a tolerance of up to 5.5 V, it is possible to apply 5 V to the inputs.

ELECTRICAL CHARACTERISTICS

DC Characteristics

(Ta = 0 to +70°C, V_{DD} (DV_{DD}, ADV_{DD}, AV_{DD}) = 3.0 to 3.45 V)

Parameter	Symbol	Condition	Min.	Typ.	Max.	Unit
"H" Level Output Voltage	V _{OH}	I _{OH} = -4 mA (*1)	0.7 × V _{DD}	—	V _{DD}	V
		I _{OH} = -6 mA (*2)				
"L" Level Output Voltage	V _{OL}	I _{OL} = 4 mA (*1)	0	—	0.4	V
		I _{OL} = 6 mA (*2)				
Input Leakage Current	I _I	V _I = GND to V _{DD}	-10	—	+10	μA
		R _{pull_down} = 50 kΩ (*3)	20	—	250	μA
Output Leakage Current	I _O	V _I = GND to V _{DD}	-10	—	+10	μA
SDA Output Voltage	SDAV _L	I _{OL} = 4 mA	0	—	0.4	V
SDA Output Current	SDAI _O	—	3	—	—	mA

*1: HSYNC_L, VSYNC_L, SYssel, C[7:0], B[7:0], ODD, VVALID, HVALID, CLKXO, HSY, M[7:0]

*2: Y[7:0], CLKX2O

*3: MODE[3:0], SCAN, TEST[2:0], PLLSEL, CLKSEL, GAINS[2:0], INS[2:0]

DC Characteristics (Analog Unit)

(Ta = 0 to +70°C, V_{DD} (DV_{DD}, ADV_{DD}, AV_{DD}) = 3.0 to 3.45 V, GND = 0 V)

Parameter	Symbol	Condition	Min.	Typ.	Max.	Unit
AMPOUT Output Voltage	V _{OAMP}	R _O = 300 Ω	0.3	—	2.4	V
CLPOUT Output Voltage	V _{OCLP}	R _O = 5 kΩ	0.2	—	1.6	V
VRT Output Voltage	V _{RT}	(*)	1.95	2.3	2.5	V
VRB Output Voltage	V _{RB}	(*)	0.15	0.3	0.4	V
ADIN	V _{IADIN}	—	V _{RB}	—	V _{RT}	V
VIN	V _{IVIN}	Capacitive coupling	0.4	—	1.3	V _{P-P}
Input Current	I _{IVIN}	V _I = 1.5 V	5	—	30	μA

*: 10 kΩ connected between V_{RT} and V_{RB}

DC Characteristics

(Ta = 0 to +70°C, V_{DD} (DV_{DD}, ADV_{DD}, AV_{DD}) = 3.0 to 3.45 V, GND = 0 V)

Parameter	Symbol	Condition	Min.	Typ.	Max.	Unit
Power Supply Current (Operating)	I _{D1}	AD1 on AD2 off CLKX2 = 27 MHz	120	190	260	mA
Power Supply Current (Operating)	I _{D2}	AD1 on AD2 on CLKX2 = 27 MHz	120	200	275	mA
Power Supply Current (Sleep)	I _{DOFF}	V _I = 1.5 V	0	—	5	mA

AC Characteristics (Double Speed Mode)

(Ta = 0 to +70°C, V_{DD} (DV_{DD}, ADV_{DD}, AV_{DD}) = 3.0 to 3.45 V, GND = 0 V)

Parameter	Symbol	Condition	Min.	Typ.	Max.	Unit
CLKX2 Cycle Frequency	1/t _{CLKX2}	ITU-RS601	—	27.0	—	MHz
		NTSC 4fsc	—	28.63636	—	MHz
		NTSC Square Pixel	—	24.545454	—	MHz
		PAL Square Pixel	—	29.5	—	MHz
CLKX2 Duty	t _{D_D2}	—	45	—	55	%
Output Data Delay Time 1 (*)	t _{OD21}	CLKSEL : L	7 (5)	—	26 (24)	ns
Output Data Delay Time 2 (*)	t _{OD22}	CLKSEL : L	6 (4)	—	22 (20)	ns
Output Data Delay Time 3 (*)	t _{OD23}	CLKSEL : L	7 (5)	—	30 (28)	ns
Output Data Delay Time 1X1 (*)	t _{ODX21}	CLKSEL : L	2	—	8	ns
Output Data Delay Time 1X2 (*)	t _{ODX22}	CLKSEL : L	1	—	5	ns
Output Data Delay Time 1X3 (*)	t _{ODX23}	CLKSEL : L	2	—	10	ns
Output Data Delay Time 2X1 (*)	t _{OD2X21}	CLKSEL : L	3 (1)	—	11 (9)	ns
Output Data Delay Time 2X2 (*)	t _{OD2X22}	CLKSEL : L	2 (1)	—	9 (7)	ns
Output Data Delay Time 2X3 (*)	t _{OD2X23}	CLKSEL : L	3 (1)	—	13 (11)	ns
Output Clock Delay Time (*) (CLKX2-CLKX0)	t _{CXD21}	CLKSEL : L	5	—	20	ns
Output Clock Delay Time (*) (CLKX2-CLKX20)	t _{CXD22}	CLKSEL : L	4	—	17	ns
SCL Clock Cycle Time	t _{C_SCL}	R _{pull_up} = 4.7 kΩ	200	—	—	ns
SCL Low Level Cycle	t _{L_SCL}	R _{pull_up} = 4.7 kΩ	100	—	—	ns
RESET_L Width	t _{RST_W}		200	—	—	ns

(*) Output load: 40 pF

Values in the parentheses indicate the delay time when 8-bit YCbCr format data is output from the Y pin.
The clock frequency accuracy is within ±100 ppm.

AC Characteristics (Single Speed Mode)(Ta = 0 to +70°C, V_{DD} (DV_{DD}, ADV_{DD}, AV_{DD}) = 3.0 to 3.45 V, GND = 0 V)

Parameter	Symbol	Condition	Min.	Typ.	Max.	Unit
CLKX2 Cycle Frequency	1/t _{CLKX2}	ITU-RS601	—	13.5	—	MHz
		NTSC 4fsc	—	14.31818	—	MHz
		NTSC Square Pixel	—	12.272727	—	MHz
		PAL Square Pixel	—	14.75	—	MHz
CLKX2 Duty	t _{D_D1}	CLKSEL : H	40		60	%
Output Data Delay Time 1 (*)	t _{OD11}	CLKSEL : H	8	—	26	ns
Output Data Delay Time 2 (*)	t _{OD12}	CLKSEL : H	7	—	22	ns
Output Data Delay Time 3 (*)	t _{OD13}	CLKSEL : H	8	—	30	ns
Output Data Delay Time 1X1 (*)	t _{ODX11}	CLKSEL : H	2	—	8	ns
Output Data Delay Time 1X2 (*)	t _{ODX12}	CLKSEL : H	1	—	5	ns
Output Data Delay Time 1X3 (*)	t _{ODX13}	CLKSEL : H	2	—	12	ns
Output Data Delay Time 2X1 (*)	t _{OD2X11}	CLKSEL : H	3	—	11	ns
Output Data Delay Time 2X2 (*)	t _{OD2X12}	CLKSEL : H	2	—	8	ns
Output Data Delay Time 2X3 (*)	t _{OD2X13}	CLKSEL : H	3	—	15	ns
Output Clock Delay Time (*) (CLKX2-CLKX0)	t _{CXD11}	CLKSEL : H	6	—	20	ns
Output Clock Delay Time (*) (CLKX2-CLKX20)	t _{CXD12}	CLKSEL : H	5	—	17	ns
SCL Clock Cycle Time	t _{C_SCL}	R _{pull_up} = 4.7 kΩ	200	—	—	ns
SCL Low Level Cycle	t _{L_SCL}	R _{pull_up} = 4.7 kΩ	100	—	—	ns
RESET_L Width	t _{RST_W}		200	—	—	ns

(*) Output load: 40 pF

The clock frequency accuracy is within ±100 ppm.

INPUT AND OUTPUT TIMING

Clock and Output Timing

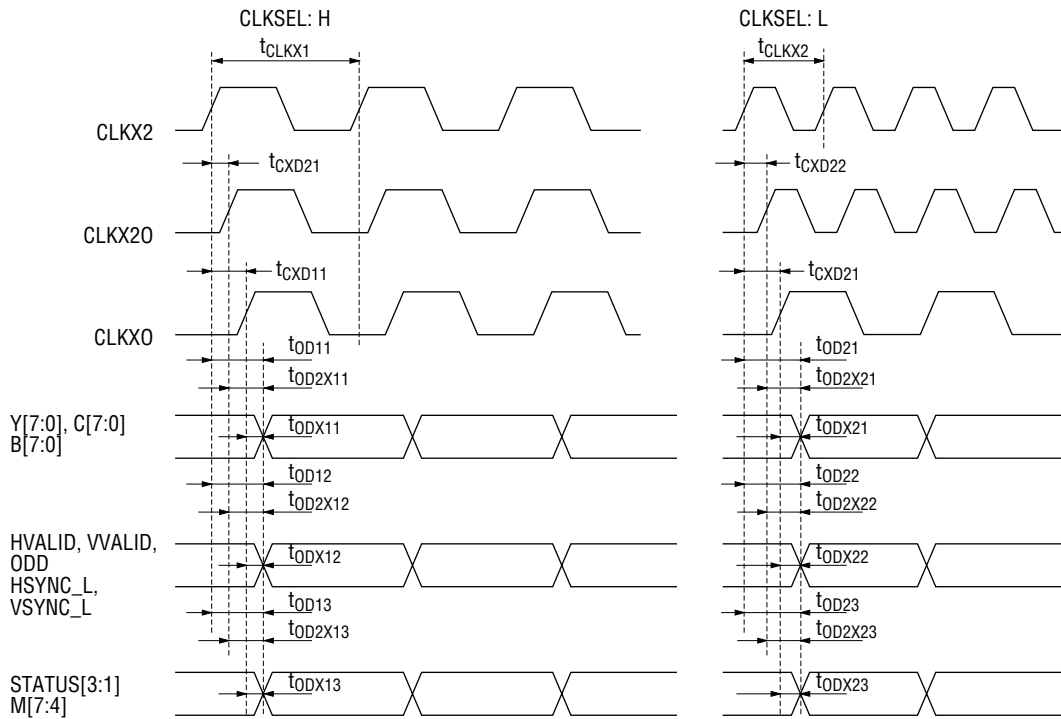

Data Delay (when a standard signal is input)

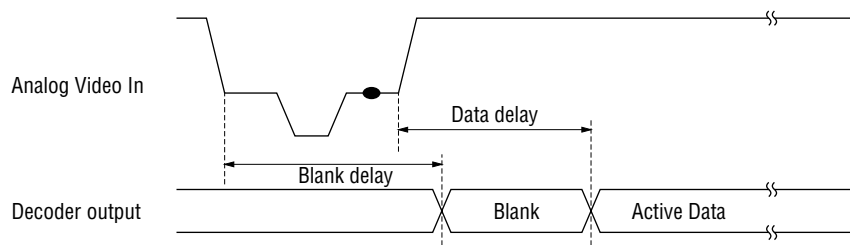

$T = 1$ pixel rate, $\alpha =$ absorption difference

Video Mode	Input Signal	FIFO/FM Mode	Amount of Delay
NTSC	Composite	FIFO-1	$1H + 358T \pm \alpha$
NTSC	Composite	FM	$1H + 358T$
PAL	Composite	FIFO-1	$1H + 358T \pm \alpha$
PAL	Composite	FM	$1H + 358T$
NTSC, PAL	S-Video	FIFO-1	$358T \pm \alpha$
NTSC, PAL	S-Video	FM	$358T$

The data delay is equal to the blank delay. 1H depends on the sampling mode. The numeric value (T value) may be changed according to a signal state. Since the output period is fixed during FIFO mode, the amount of delay is changed. If Y/C separation is performed using TRAP filter during PAL mode, 1H is not added.

I²C-bus Interface Input/Output Timing

The basic input/output timing of the I²C-bus is indicated below.

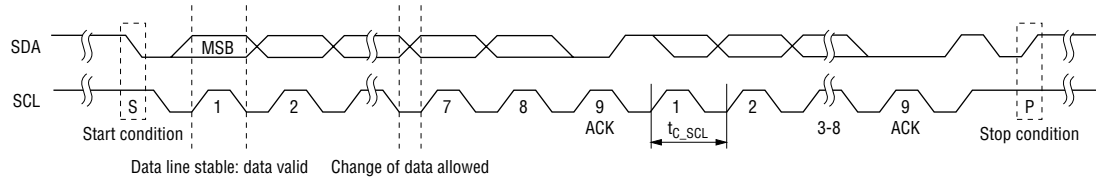

I²C-bus Timing

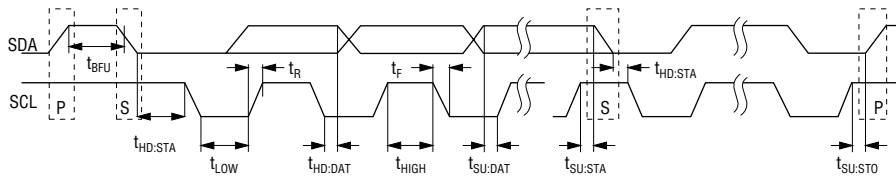

Symbol	Parameter	Min.	Max.	Unit
f_{SCL}	SCL Frequency	0	100	kHz
t_{BUF}	Bus Open Period	4.7		μ s
$t_{HD: STA}$	Start Condition Hold Time	4.0		μ s
t_{LOW}	Clock Low Period	4.7		μ s
t_{HIGH}	Clock High Period	4.0		μ s
$t_{SU: STA}$	Start Condition Setup Time	4.7		μ s
$t_{HD: DAT}$	Data Hold Time	300		ns
$t_{SU: DAT}$	Data Setup Time	250		ns
t_R	Line Rise Time		1	μ s
t_F	Line Fall Time		300	ns
$t_{SU: STO}$	Stop Condition Setup Time	4.7		μ s

The I²C-bus timing conforms to this table. However, the I²C-bus can operate faster than at the speeds, specified above. Actually, the SCL frequency is up to about 5 MHz. The hold time and setup time in that case must conform to the ratio described in the above table.

FUNCTIONAL DESCRIPTION

Analog Unit

- 1) Analog input select: Compatible with composite video signals and S-video signals. Input selection can be switched by register control via the I²C-bus or by external pins. (See the below chart for pin combinations.)
When the LSI is used in Composite video mode, input clocks or do resetting after setting S-video mode (101), (110) before setting Composite video mode.
- 2) Clamp function: An analog clamp and a digital pulse clamp can be used.
Analog clamp
Analog clamp → Digital clamp (hybrid clamp)
Digital clamp
Only the digital clamp can be set as the pedestal clamp.
Related register MRB[3:2]
- 3) AGC amp: The AGC function operates depending upon the input level.
Manual gain setting is also possible. This AGC function operates at 2 stages, the analog unit and digital unit. Digital decoded data is output in conformance with ITU-RBT.601.
Refer to the explanation of M[1] pin (pin 90).
Related register ADC2[6:4]
- 4) A/D converter: Two internal 8-bit A/D converters sample at twice the pixel frequency. (Sampling at the pixel frequency is possible by changing the register setting.)
Related register ADC1[2:0]

List of Analog Input Conditions

Input Signal	Control Pin	Register	Input Pin						ADC Selection		
			INS[2:0]	ADC1[2:0]	VIN1	VIN2	VIN3	VIN4	VIN5	VIN6	ON
Composite-1 Input*	[000]	[000]	Composite							ON	OFF
Composite-2 Input	[001]	[001]		Composite						ON	OFF
Composite-3 Input	[010]	[010]			Composite					ON	OFF
Composite-4 Input	[011]	[011]				Composite				ON	OFF
Composite-5 Input	[100]	[100]					Composite			ON	OFF
S-video-1 Input	[101]	[101]	Luminance					Chroma		ON	ON
S-video-2 Input	[110]	[110]		Luminance					Chroma	ON	ON
All inputs Off	[111]	[111]	OFF (Sleep)						OFF	OFF	

Blank spaces: non-selectable, *: register default setting after LSI reset
M[1] pin setting, 0: external mode, 1: internal register mode

Manual Gain Control (analog AMP gain)

Gain Setting Pins GAINS[2:0]	Register ADC2[6:4]	Set Gain Value Typ. Value (multiplication factor)
[000]	[000]	1.0
[001]	[001]	1.35
[010]	[010]	1.75
[011]	[011]	2.3
[100]	[100]	3.0
[101]	[101]	3.8
[110]	[110]	5.0
[111]	[111]	Undefined

Decoder Unit

1. Prologue Block

The prologue block inputs data and performs Y/C separation.

Data can be input at either the pixel frequency (ITU-RBT.601: 13.5 MHz) or at twice the pixel frequency (ITU-RBT.601: 27 MHz). If input at twice the pixel frequency, data is processed after passing through a decimator circuit to convert it to the pixel frequency. The decimator circuit may be bypassed by changing the register setting, regardless of whether data is input at the normal pixel frequency or at twice the pixel frequency.

If a composite signal (CVBS) is input, the default setting performs Y/C separation using a 2-dimensional adaptive comb filter.

The following operating modes can be selected via the I²C-bus. Default settings are indicated by an asterisk (*). The default state is selected at reset.

- 1) Video input mode selection (related register MRC[7])
 - NTSC/PAL auto-select* (only for ITU-RBT.601)
 - Dependent upon operating mode selected

When ITU-RBT.601 is selected, the video input mode is automatically set depending upon the number of lines per field.

- 2) Operating mode selection (related register MRA[3:1])

NTSC ITU-RBT.601	13.5 MHz*
NTSC Square Pixel	12.272727 MHz
NTSC 4fsc	14.31818 MHz
PAL ITU-RBT.601	13.5 MHz
PAL Square Pixel	14.75 MHz

Even if input at twice the pixel frequency, the internal processing is performed at the pixel frequency.

- 3) Decimator circuit pass/bypass selection (related register MRC[4])
 - Pass through decimator circuit*
 - Bypass decimator circuit

Compatible only when input at twice the pixel frequency.
- 4) Y/C separation mode selection (related register MRB[1:0])
 - Use adaptive comb filter*
 - Use non-adaptive comb filter
 - Do not use comb filter (use trap filter)

The adaptive comb filter for a NTSC signal makes the correlation between up to 3 consecutive lines, and Y/C separation is performed by the 3-line or 2-line comb filter according to the format of correlation.

The adaptive comb filter for a PAL signal makes the correlation between only 2 lines and performs Y/C separation by switching between the 2-line comb filter and trap filter.

At that time, the adaptive transition method is employed in which the filter is gradually switched depending on the level of correlation.

The non-adaptive comb filter performs Y/C separation by removing the luminance component based on the average of preceding and following lines (when there is correlation between 3 lines). (the average of 2 lines in the case of a PAL signal)

When a comb filter is not used, Y/C separation is performed by a trap filter.

If an S-video signal is input, these Y/C separation circuits are bypassed.

The functions of this block only operate when lines are valid as image information. During the V blanking interval, CVBS signals are not processed.

2. Luminance Block

The luminance block removes synchronous signals from signals containing luminance components after Y/C separation. The signals are compensated and then output as luminance signals. Two modes of gain control functions can be selected for the luminance signal output level: AGC (Auto Gain Control) and MGC (Manual Gain Control).

In the AGC mode, luminance level amplification is determined by comparing the SYNC depth with a reference value. The default is 40IRE and can be changed by the register setting. The input has a sync tip clamp.

In the MGC mode, the signal amplification and black level can be changed by register settings. This block can select the following operating modes.

- 1) Selection of luminance level limiter usage (related register LUMC[7])
 - Do not use*
 - Use

When a limiter is used, the luminance level is limited to 16 to 235.
- 2) Selection of prefilter and sharp filter usage (related register LUMC[6])
 - Do not use*
 - Use

These filters are used to enhance the edges of luminance component signals. Two filters operate in pairs. For their characteristics, refer to Filter Characteristics described later.
- 3) Selection of aperture bandpass filter coefficient (related register LUMC[5:4])
 - Middle range*
 - High range
- 4) Coring range selection (related register LUMC[3:2])
 - Off*
 - ±4LBS
 - ±5LBS
 - ±7LBS
- 5) Aperture weighting coefficient selection (related register LUMC[1:0])
 - 0*
 - 0.25
 - 0.75
 - 1.50

Both coring and aperture compensation processes perform contour compensation.
- 6) Selection of pixel position compensating circuit usage (related register MRC[6])
 - Use*
 - Do not use

7) AGC loop filter time constant selection (related register AGCLF[7:6])

Slow	convergence time	903 ms
Medium		225 ms*
Fast		56 ms
MGC mode		0

These are designed times from the input gain being rapidly lowered to 50% (-6 dB) of the value at a stable state when normal signals are input till the output being returned to -1 dB (actually these times differ depending on the signal state).

MGC mode: manual gain setting is possible by register AGCLF[5:0]

Set the SSEPL[7] value to a 0 when the MGC mode is used.

8) Parameter for fine adjustment of AGC sync depth (related register AGCLF[5:0])

AGC reference level is changed.

9) Parameter for fine adjustment of sync removal level (related register SSEPL[6:0])

The black level is adjusted. The default setting outputs the pedestal position as a black level (=16).

10) Pedestal clamp selection (related register SSEPL[7])

Do not use pedestal clamp*

Use pedestal clamp (at this time, AGC does not operate, MGC operates)

3. Chrominance Block

This block processes the chroma signals.

The following operating modes can be selected.

1) Selection of chroma bandpass filter usage (related register CHRC[2])

Do not use*

Use

2) ACC loop filter time constant selection (related register ACCLF[6:5])

Fast2	convergence time	27 ms
Medium		424 ms*
Fast		106 ms
MCC mode		0

These are designed times from the input gain being rapidly lowered to 50% (-6 dB) of the value at a stable state when normal signals are input till the output being returned to -1 dB (actually these times differ depending on the signal state).

MCC mode: manual gain setting is possible by register ACCLF[4:0]

3) ACC reference level fine adjustment (related register ACCLF[4:0])

ACC reference level is changed.

4) Parameter for burst level fine adjustment (related register CHRC[1:0])

Threshold level at which chroma amplitude becomes valid is selected based upon color burst ratio.

0.5

0.25*

0.125

Off

Off: The color killer function is turned off. If decoloration occurs while decoding a still picture, setting the threshold level to "off" will reduce the decoloration.

5) Color killer mode selection (related register MRB[5])

Auto color killer mode*

Forced color killer

6) Parameter for fine adjustment of color subcarrier phase (related register HUE[7:0])

HUE control function

7) Vertical color filter (related register CHRC[6:4])

Averaging computation is made for the lines before and after the U, V demodulated signal. This is likely to make the image appear smooth.

Using a register, it is possible to select the modes of either to carry out or not carry out the averaging operation based on the correlation between the previous and next lines, or not to carry out the averaging operation at all. In addition, it is also possible to change the level of judging the correlation using a register setting.

In this block, chroma signals pass through a bandpass filter to cut out unnecessary band.

To maintain a constant chroma level, these signals then pass through an ACC compensating circuit and are UV demodulated. (The filter can be bypassed.)

If the demodulated result does not reach a constant level, color killer signals are generated to fix the ACC gain. This functions as an auto color killer control circuit.

The UV demodulated results pass through a low-pass filter and are output as chrominance signals.

4. Synchronization Block

This block processes the sync signals. Synchronous signals are generated for chip output and for internal use. Various signals are output from this block and the following operating modes can be selected.

- 1) Adjustment of SYNC threshold level (internal sync) (related register STHR[7:0])
SYNC detection level is set.
- 2) Fine adjustment of HSY (Horizontal Sync Clamp) signal (related registers HSYT[7:4], HSYT[3:0], MRB[3:2])
 - 2-1) Fine adjustment of HSY signal (start side)
 - 2-2) Fine adjustment of HSY signal (stop side)

The HSY signal provides the sync-tip and clamp timing to the A/D converter.
This signal is used for digital clamp, but can not be observed from outside.
- 3) Fine adjustment of HSYNC_L signal (related register HSDL[7:0])
HSYNC_L signal output position is adjusted.
- 4) HVALID control (related registers HVALT[7:4], HVALT[3:0])
 - 4-1) Fine adjustment of HVALID signal (start side)
 - 4-2) Fine adjustment of HVALID signal (stop side)

Data signals are transferred at the rising edge of the HVALID signal.
- 5) VVALID control (related registers VVALT[7:4], VVALT[3:0])
 - 5-1) Fine adjustment of VVALID signal (start side)
 - 5-2) Fine adjustment of VVALID signal (stop side)
- 6) FIFO and Field Memory mode selection (related register MRB[7:6])
 - FIFO-1 mode*: Sets and outputs a standard value for the number of pixels per 1H from the internal FIFO.
This mode is also compatible (to a degree) with non-standard VTR signals.
 - FIFO-2 mode: Sets and outputs a constant pixel number corresponding to the input H interval for the number of pixels per 1H from the internal FIFO.

- FM-1 mode: This mode outputs the decoded results according to the SYNC signal. Usage of external field memory is required to manage the number of pixels and to absorb jitter. Memory control signals are to be generated externally.
- FM-2 mode: This mode is compatible with considerably distorted non-standard VTR signals. Jitter is absorbed by using external field memory (2 Mb × 2) and the standard value is set as the pixel number. Field memory control signals are output simultaneously from M[7:4].
- 7) Field memory control signals
If the FM-2 mode uses external field memory (2 Mb × 2) instead of the internal FIFO, field memory control signals are supplied from pins M[7:4]. At this time, pin M[0] requires to be set to "H".

5. Epilogue Block

The Epilogue Block outputs the UV signal from the Chrominance block and the Y signal from the Luminance block in a format based on a signal obtained from the control register setting. This block can select the following modes.

- 1) Output mode selection (related register MRA[7:6])
 - 1-1) ITU-RBT.656 (SAV, EAV, blank processing)
 - 1-2) * 8-bit (YCbCr) output (2x pixel clock) synchronization with HSYNC_L, VSYNC_L
 - 1-3) 16-bit (8-bit Y/8-bit CbCr) (pixel clock) synchronization with HSYNC_L, VSYNC_L
 - 1-4) 24-bit RGB (8 bits each) synchronization with HSYNC_L, VSYNC_L
- 2) Enable Blue Back display when synchronization fails (related register MRB[4])
 - OFF
 - ON*
- 3) Selection of YCbCr signal output format (related register MRC[5])
 - YCbCr 4 : 2 : 2*
 - YCbCr 4 : 1 : 1

The chrominance signal (U, V component) outputs Cb and Cr data to the C pin in an output format to be described later.
- 4) Output pin enable selection (related registers OMR[2], MISC[1:0])
 - High-impedance
 - Output enable*

Pins that become high impedance are determined by setting. See "Output Pin Control Table" described later.
- 5) Various mode detection (related register OMR[1:0])
 - NTSC/PAL detection
 - Multiplex signal detection
 - HSYNC synchronization detection
 - Internal FIFO overflow detection
- 6) Output signal phase control (related registers OPCY[1:0], OPCC[1:0])

Y and C phases can each be adjusted in the range of -2 to +1 pixels.

6. VBID Block

The VBID Block detects AGC, CC, WSS and CGMS data from the input luminance signal and holds them. The VBID module consists of the following four modules.

The detection line and detection level can be changed by setting of the register.

1) AGC module

This module detects whether the macrovision AGC pulse (NTSC/PAL) is included in the specified line. If the AGC pulse has been detected in the specified lines, the flag is set.

- NTSC-specified lines: 12 to 19 odd-numbered lines
275 to 282 even-numbered lines
- PAL-specified lines: 9 to 18 odd-numbered lines
321 to 330 even-numbered lines

2) C.C. (Closed Caption) module

This module detects whether the closed caption data (NTSC/PAL) is included in the specified lines. If it has been detected in the specified lines, character data on the odd number lines and character data on the even number lines are individually held and flags are set for each data separately.

- NTSC-specified lines: 21 odd-numbered lines
284 even-numbered lines
- PAL-specified lines: 22 odd-numbered lines
3350 even-numbered lines

3) WSS (Wide Screen Signalling) module

This module detects WSS data on the lines specified by NTSC. If it has been detected, the flag is set.

(PAL only)

- PAL-specified lines: 23 lines

4) CGMS module

This module detects CGMS data on the lines specified by IEC61880.

If it has been detected, the flag is set (NTSC only)

- NTSC-specified lines: 20 odd-numbered lines
283 even-numbered lines

7. I²C Control Block

This serial interface block is based on the I²C standard of the Phillips Corporation.

The registers at up to subaddress Hex14 are write-only registers and the register at subaddress Hex20 is a read-only register.

The license to use the LSI chip for I²C systems is granted on the basis of the I²C patent of the Phillips Corporation by purchasing the LSI chip.

8. Test Control Block

This block is used to test the LSI chip. Normally this block is not used.

Input Signal Level

The figure below shows the recommended range of the input signal, received in an 8-bit straight binary format.

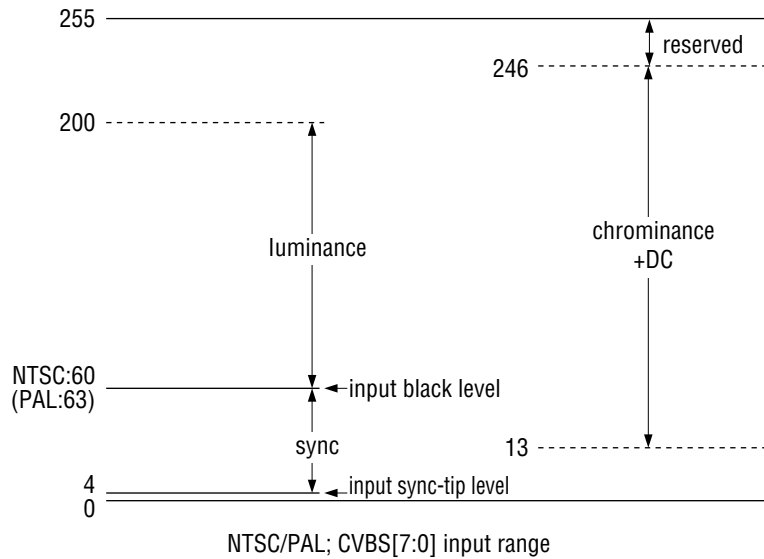

The above input conditions are ideal. Because analog signals are normally input at different levels, the exact settings described above are difficult to achieve. While maintaining the ratio of White Peak (100%)/SYNC = 100IRE/40IRE (NTSC), if the input signal is set within the A/D converter's voltage range/the Y digital output will be output by digital AGC operation with the pedestal position set at the black level (16) and the white peak position (100%) set at the peak level (235) even if the peak level does not reach 196 (200 - 4).

Output format

ITU-RBT.656 output, 8-bit (YCbCr) output, and 16-bit (8-bit Y/8-bit CbCr) output have the following formats.

The YCbCr 4:2:2 format and 4:1:1 format are shown below.
The output format can be changed by register settings.

Output	Pixel Byte Sequence					
Y7 (MSB)	Y7	Y7	Y7	Y7	Y7	Y7
Y6	Y6	Y6	Y6	Y6	Y6	Y6
Y5	Y5	Y5	Y5	Y5	Y5	Y5
Y4	Y4	Y4	Y4	Y4	Y4	Y4
Y3	Y3	Y3	Y3	Y3	Y3	Y3
Y2	Y2	Y2	Y2	Y2	Y2	Y2
Y1	Y1	Y1	Y1	Y1	Y1	Y1
Y0 (LSB)	Y0	Y0	Y0	Y0	Y0	Y0
C7 (MSB)	Cb7	Cr7	Cb7	Cr7	Cb7	Cr7
C6	Cb6	Cr6	Cb6	Cr6	Cb6	Cr6
C5	Cb5	Cr5	Cb5	Cr5	Cb5	Cr5
C4	Cb4	Cr4	Cb4	Cr4	Cb4	Cr4
C3	Cb3	Cr3	Cb3	Cr3	Cb3	Cr3
C2	Cb2	Cr2	Cb2	Cr2	Cb2	Cr2
C1	Cb1	Cr1	Cb1	Cr1	Cb1	Cr1
C0 (LSB)	Cb0	Cr0	Cb0	Cr0	Cb0	Cr0
Y point	0	1	2	3	4	5
C point	0		2		4	

YCbCr 4:2:2 format

Output	Pixel Byte Sequence							
Y7 (MSB)	Y7	Y7	Y7	Y7	Y7	Y7	Y7	Y7
Y6	Y6	Y6	Y6	Y6	Y6	Y6	Y6	Y6
Y5	Y5	Y5	Y5	Y5	Y5	Y5	Y5	Y5
Y4	Y4	Y4	Y4	Y4	Y4	Y4	Y4	Y4
Y3	Y3	Y3	Y3	Y3	Y3	Y3	Y3	Y3
Y2	Y2	Y2	Y2	Y2	Y2	Y2	Y2	Y2
Y1	Y1	Y1	Y1	Y1	Y1	Y1	Y1	Y1
Y0 (LSB)	Y0	Y0	Y0	Y0	Y0	Y0	Y0	Y0
C7 (MSB)	Cb7	Cb5	Cb3	Cb1	Cb7	Cb5	Cb3	Cb1
C6	Cb6	Cb4	Cb2	Cb0	Cb6	Cb4	Cb2	Cb0
C5	Cr7	Cr5	Cr3	Cr1	Cr7	Cr5	Cr3	Cr1
C4	Cr6	Cr4	Cr2	Cr0	Cr6	Cr4	Cr2	Cr0
C3	0	0	0	0	0	0	0	0
C2	0	0	0	0	0	0	0	0
C1	0	0	0	0	0	0	0	0
C0 (LSB)	0	0	0	0	0	0	0	0
Y point	0	1	2	3	4	5	6	7
C point	0				4			

YCbCr 4:1:1 format

TIMING DESCRIPTION

Vertical Synchronizing Signal

The vertical synchronizing signal timing is as follows. The default output is as shown below, but the internal processing of the synchronizing signal is performed before 1H.

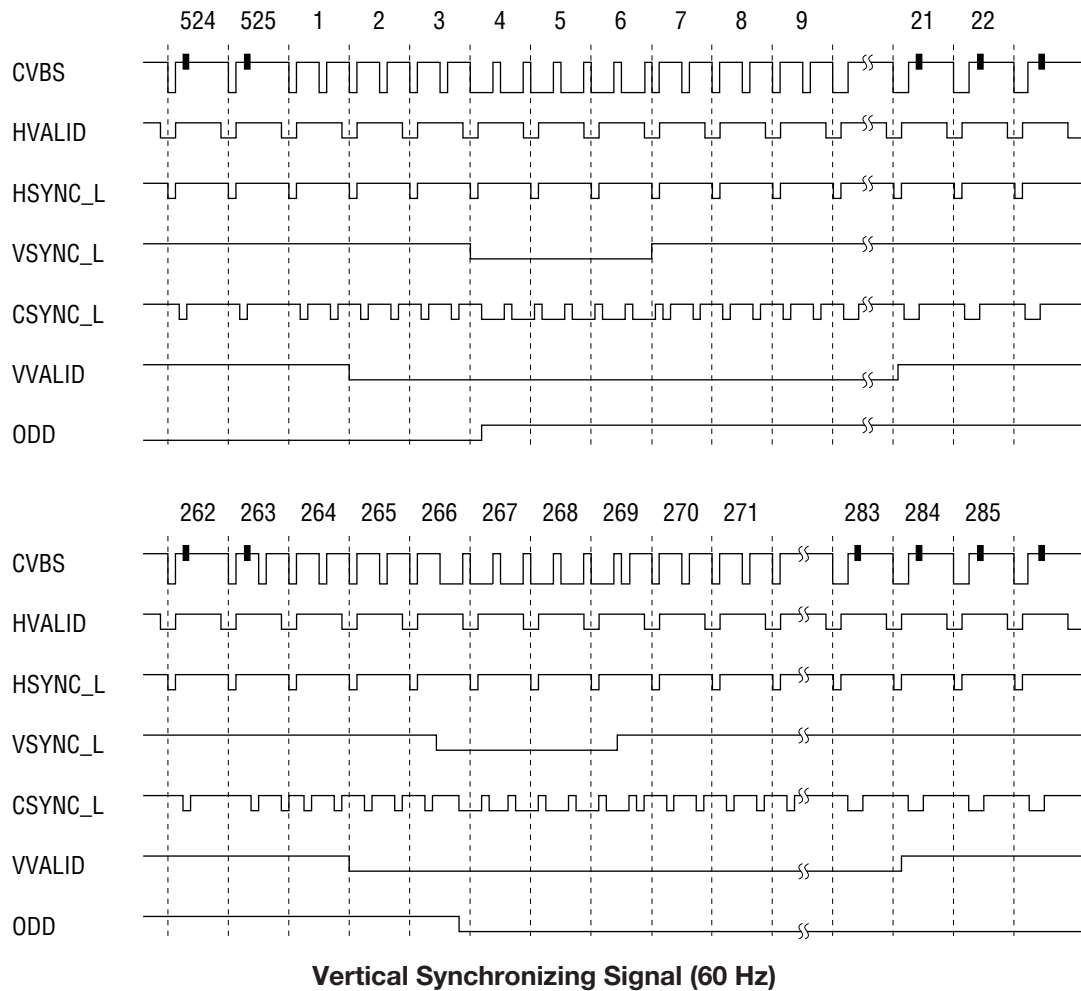

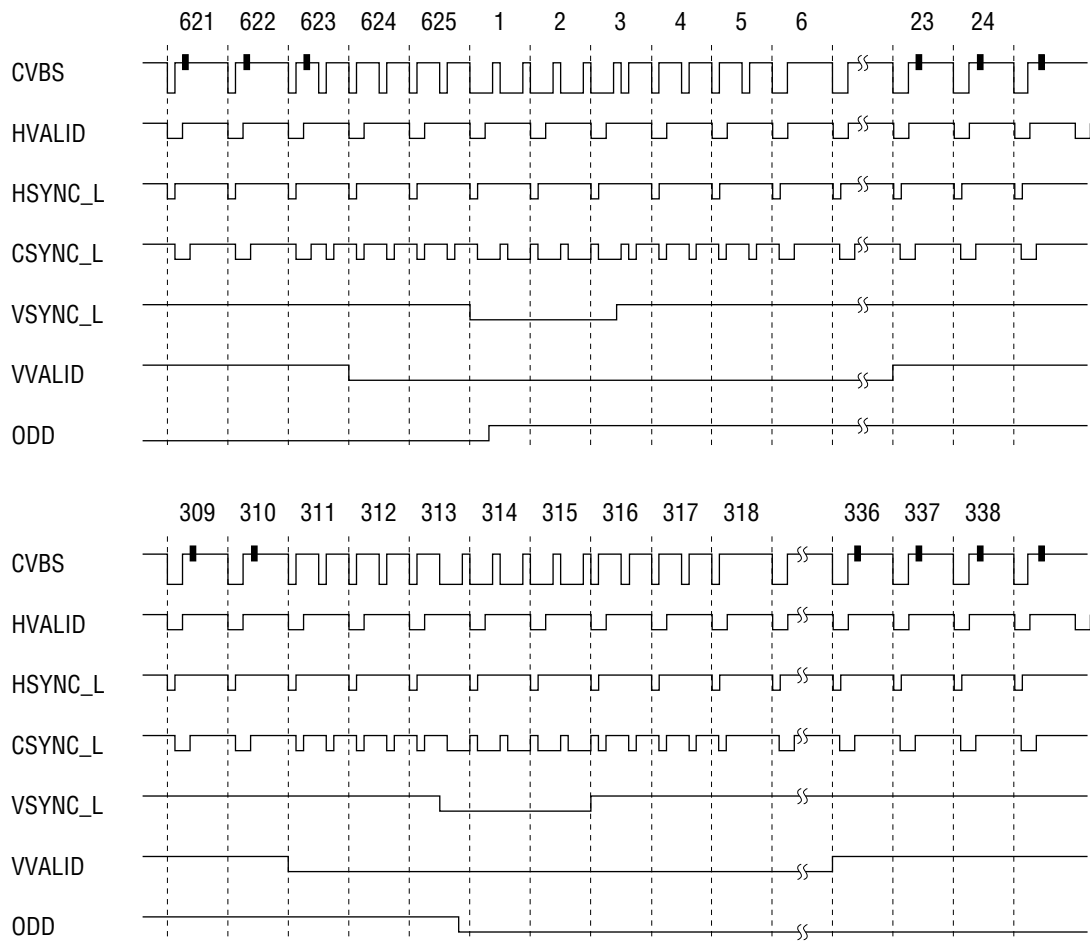

Vertical Synchronizing Signal (50 Hz)

A/D Converter Support Signal

The waveform of the HSY signal, shown below, provides clamp timing to the A/D converter when HSY clamp (digital clamp) is selected. The start and end edges of the clamp pulse have a variable range from the sync tip to the pedestal position. (HSY is an internal signal.)

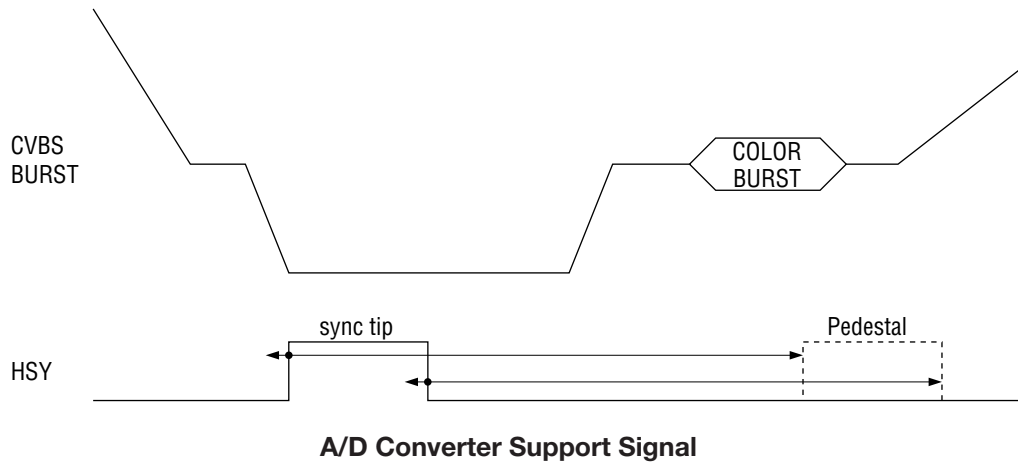

Output Timing

- ITU-RBT.656 output

T : clock periods 37 ns normal (1/27 MHz)
 SAV : start of active video timing reference code
 EAV : end of active video timing reference code

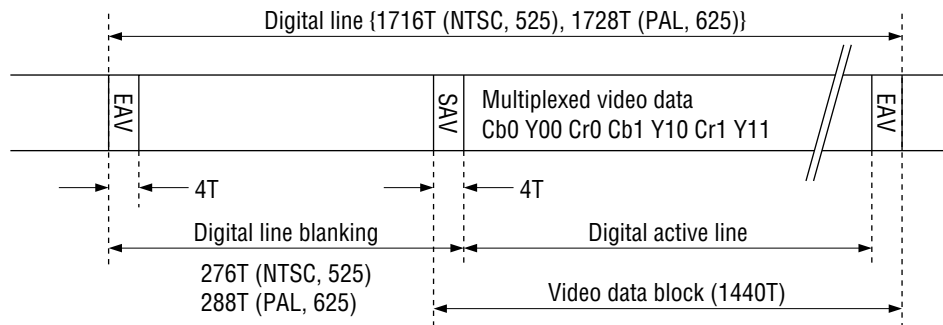

ITU-RBT.656 Output (Data in one line in which video data presents)

During the blanking interval, data is output with the Y value.

Note: Digital line 1716T (NTSC, 525) and 1728T (PAL, 625) are not maintained at the next line. Digital active line 1440T of the line immediately after VVALID falls and the 10th or 11th line after VSYNC_L rises will fluctuate due to pixel compensation. Especially when a non-standard signal is input, the line immediately after VVALID falls will fluctuate largely due to instability of the input signal. Due to phenomena such as an increase in the number of lines for a standard signal and a decrease in the number of lines for a non-standard signal, it may not be possible to guarantee correct EAV and SAV functionality.

Contents of SAV and EAV

Both SAV and EAV consist of 4 words. Their configuration is shown below.

Word	Bit No.								F = 0: during field 1 1: during field 2 V = 0: elsewhere 1: during field blanking H = 0: SAV H = 1: EAV P3, P2, P1, P0: Protection bit
	7 (MSB)	6	5	4	3	2	1	0 (LSB)	
First	1	1	1	1	1	1	1	1	
Second	0	0	0	0	0	0	0	0	
Third	0	0	0	0	0	0	0	0	
Fourth	1	F	V	H	P3	P2	P1	P0	

The 4th word of SAV and EAV

The relationship between the F, V, H and Protection bits in the 4th word of SAV and EAV is shown below.

Bit No.	7 (MSB)	6	5	4	3	2	1	0
Function	Fixed 1	F	V	H	P3	P2	P1	P0
0	1	0	0	0	0	0	0	0
1	1	0	0	1	1	1	0	1
2	1	0	1	0	1	0	1	1
3	1	0	1	1	0	1	1	0
4	1	1	0	0	0	1	1	1
5	1	1	0	1	1	0	1	0
6	1	1	1	0	1	1	0	0
7	1	1	1	1	0	0	0	1

Usually, V = 1 during blanking, however when VBI data is detected and V = 0 is the desired output, set the MRC[3] SAV, EAV V-status of Mode Register C (MRC) to "1".

Output Data Format

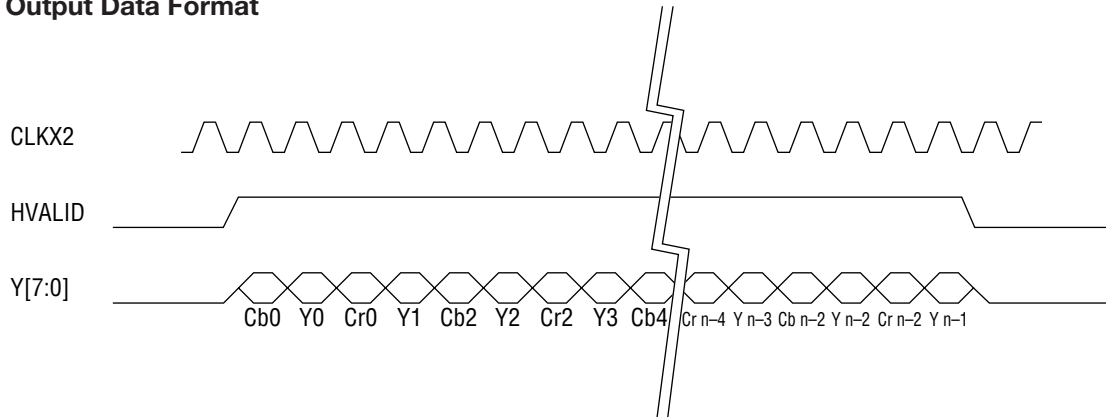

8-bit (YCbCr: 2x clock) Output

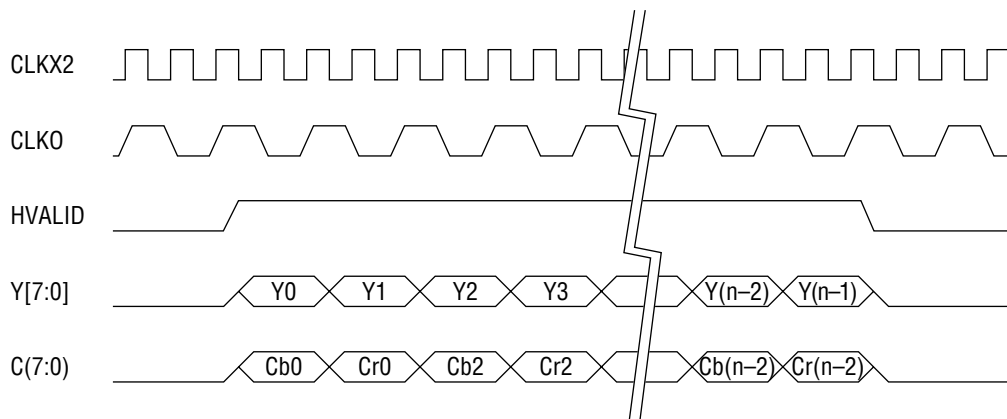

16-bit (Y: 8-bit, CbCr: 8-bit) Output

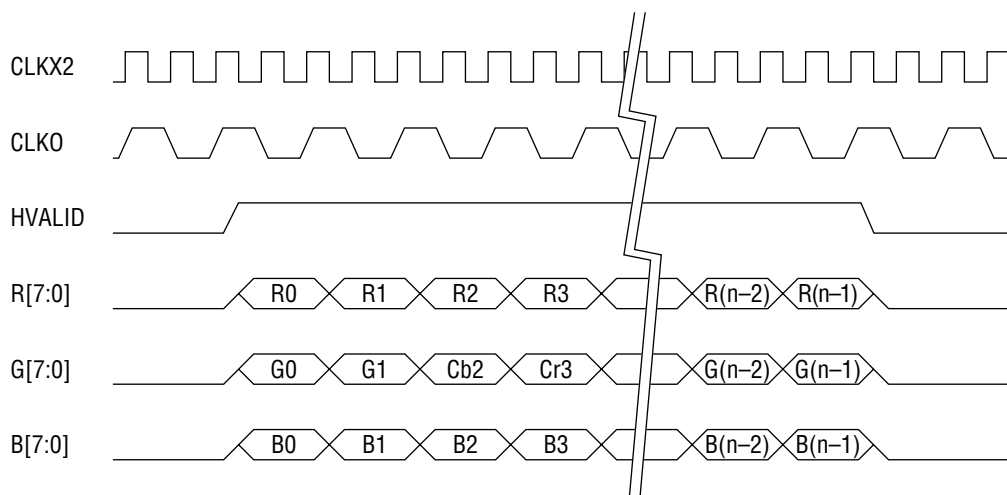

24-bit (R: 8-bit, G: 8-bit, B: 8-bit) Output

Note: When a single-speed clock (13.5 MHz, etc.) is input in 16-bit or 24-bit (RGB) output mode, the waveform of CLKX2 changes to a single speed waveform, but the format after that is not changed.

• Timing when using external field memory

Field memory timing in the FM-2 mode, using control signals from the decoder

Field memory: MSM51V8222, 2 units are used (Y and C)

Four memory control signals are supplied from the decoder, M[4]: RSTW, M[5]: RSTR, M[6]: WE:, and M[7]: RE.

NTSC Signal (13.5 MHz)

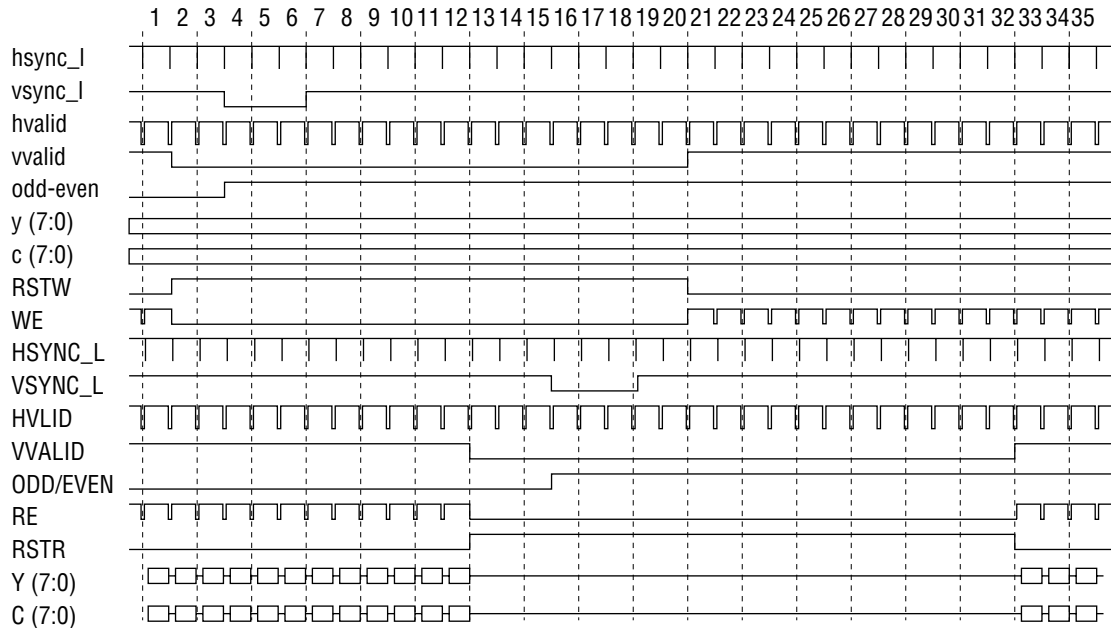

NTSC: ODD Field

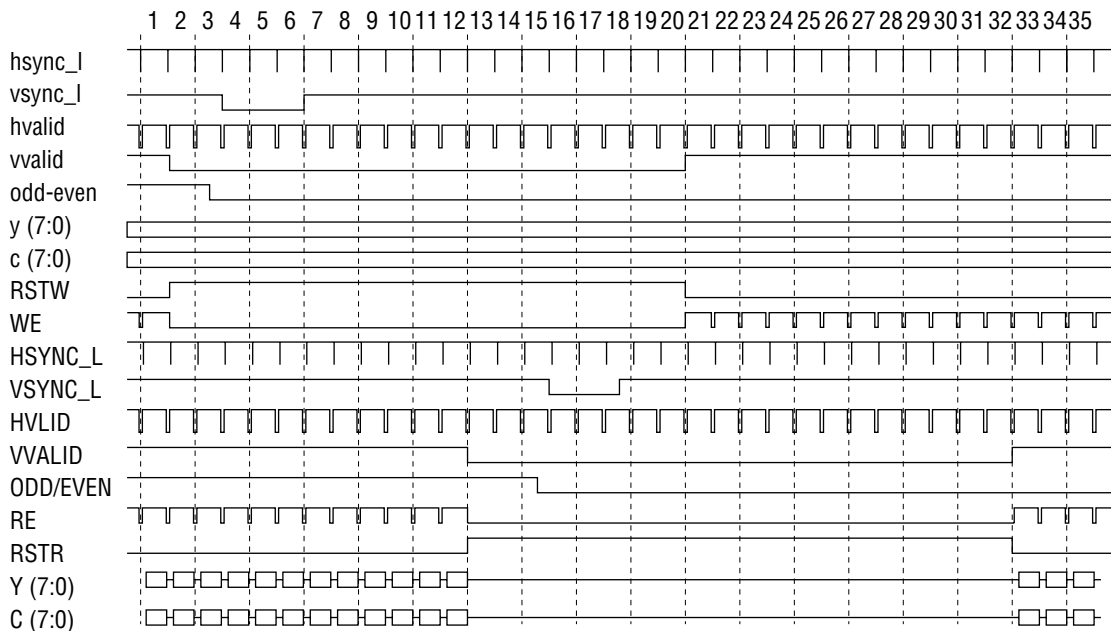

NTSC: EVEN Field

PAL Signal (13.5 MHz)

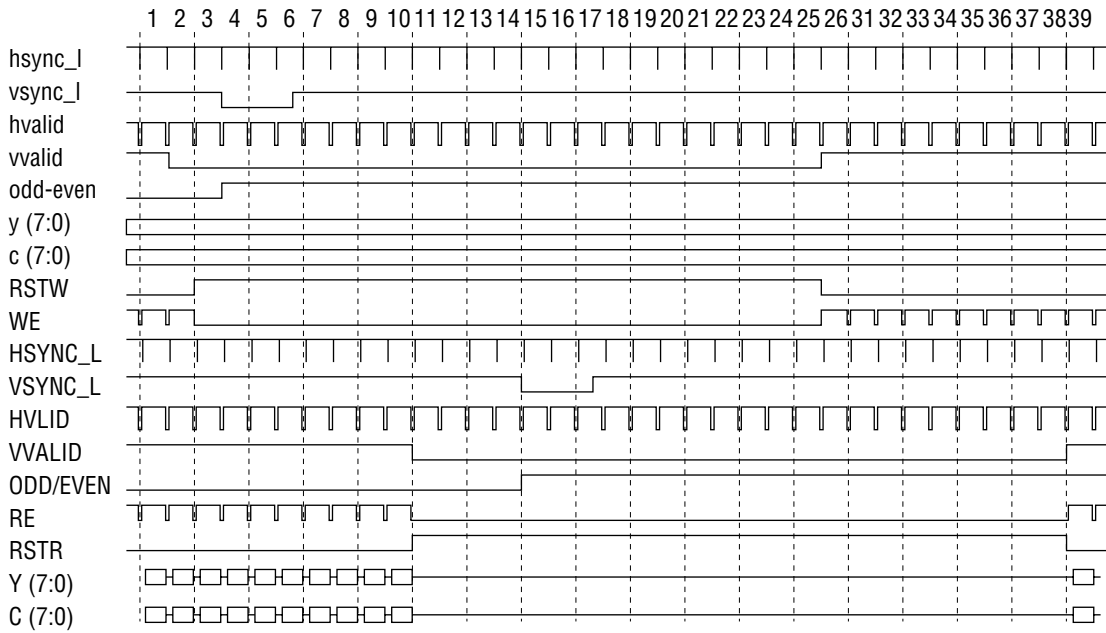

PAL: ODD Field

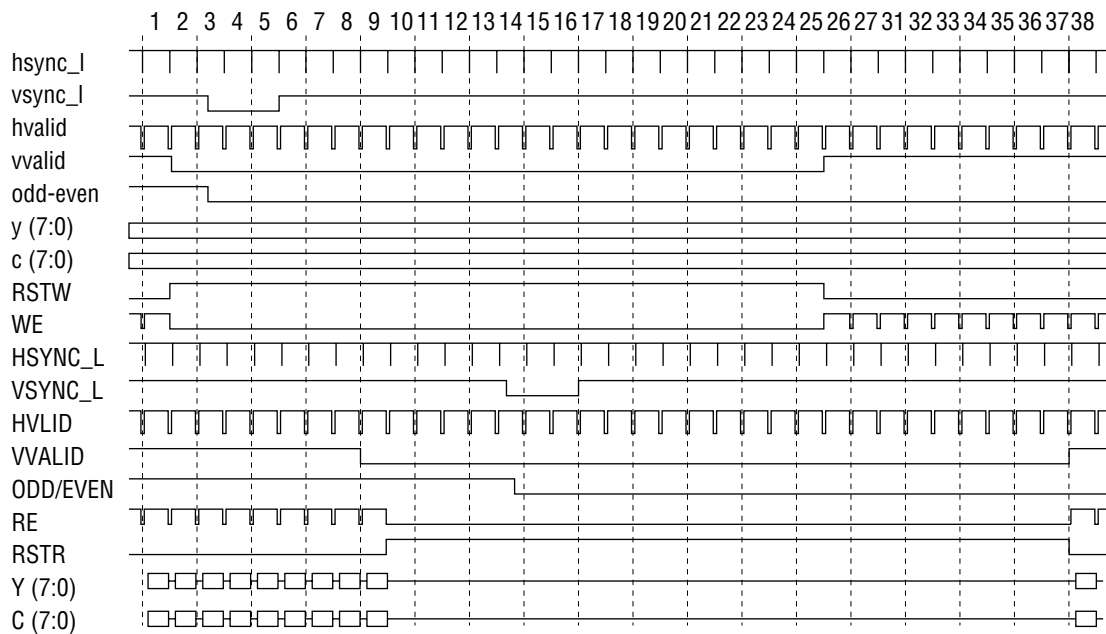

PAL: EVEN Field

Horizontal Synchronizing Signal

The horizontal synchronizing signal timing is shown below.

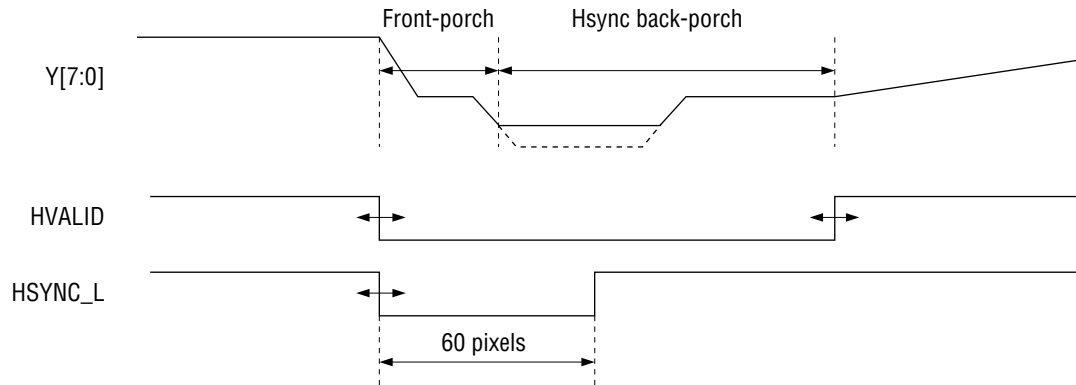

Horizontal Timing

Relation between Video Mode and Pixel Number (default settings when standard signal is input)

Video Mode	Pixel Type	Pixel Rate (MHz)	Total Pixels	Active Pixels	Front-Porch	Hsync Back-Porch	HBLK Total
NTSC	ITURBT.601	13.5	858	720	16	122	138
	Square pixel	12.272727	780	640	28	112	140
	4fsc	14.31818	910	768	8	134	142
PAL	ITURBT.601	13.5	864	720	12	132	144
	Square pixel	14.75	944	768	34	142	176

Synchronizing Signal Timing (default timing when standard signal is input)

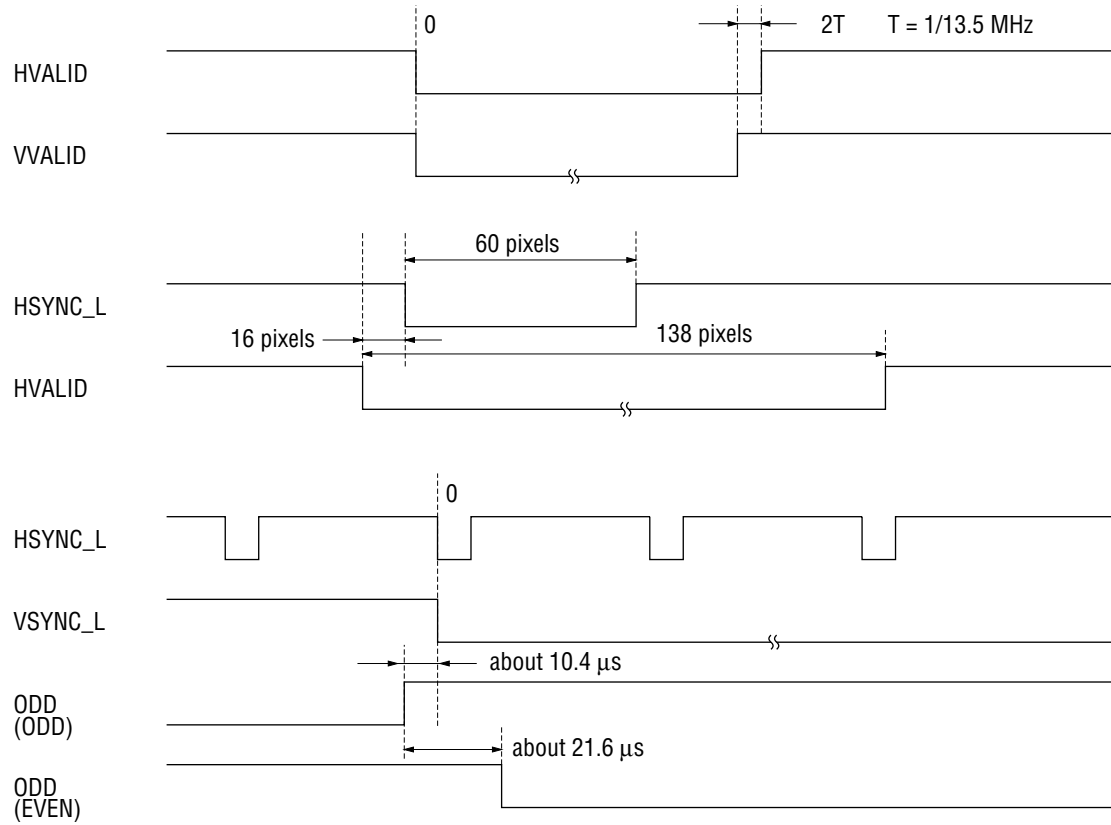

VBI Data Detection (when a Composite signal is input): STATUS1 Timing

VBI data detection results are output from the STATUS1 pin.
 Results of individual data detection are read from the register.

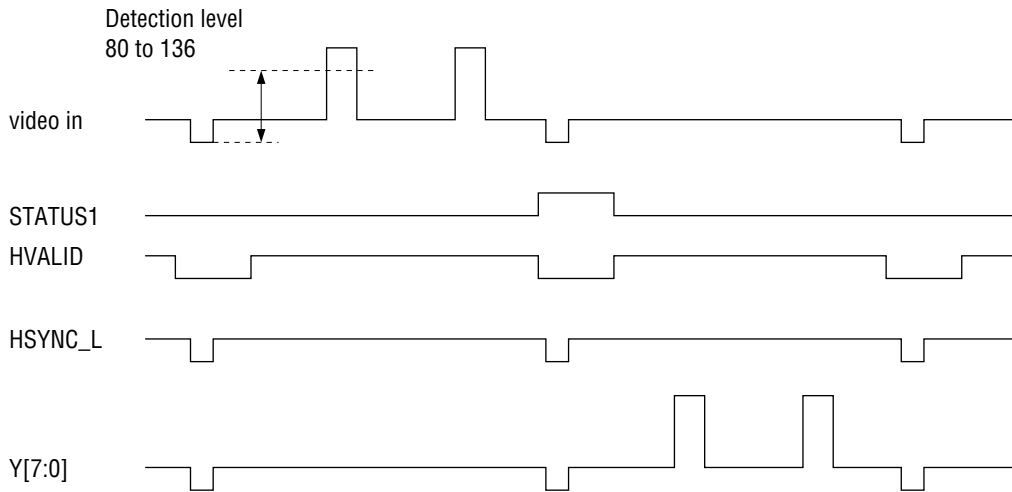

VBI Data Detection (when an S-Video signal is input): STATUS1 Timing

VBI data detection results are output from the STATUS1 pin.
 Results of individual data detection are read from the register.

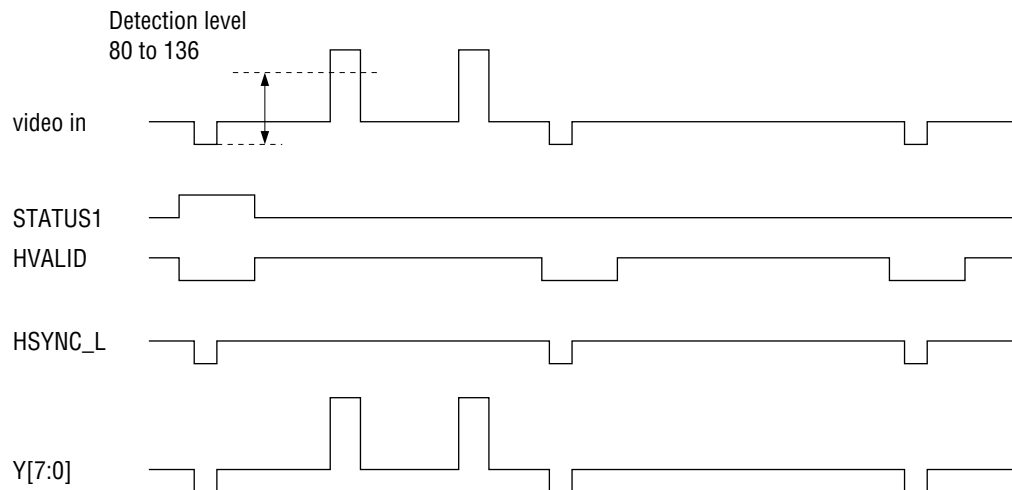

I²C BUS FORMAT

The I²C-bus interface input format is shown below.

Write Mode

S	Slave Address (W)	A	Subaddress	A	Data 0	A	Data n	A	P
---	-------------------	---	------------	---	--------	---	-------	--------	---	---

Read Mode

S	Slave Address (W)	A	Subaddress	A	S	Slave Address (R)	A	Data 20	A'
---	-------------------	---	------------	---	---	-------------------	---	---------	----

↓

.....	Data m	A'	P
-------	--------	----	---

Read Mode 2 (VBID READ)

S	Slave Address (W)	A	Subaddress (1f)	A	Reset Data	A	P	
---	-------------------	---	-----------------	---	------------	---	---	--

↓

S	Slave Address (W)	A	Subaddress (21)	A	S	Slave Address (R)	A	Data 21	A'
---	-------------------	---	-----------------	---	---	-------------------	---	---------	----

↓

.....	A	Data m	A	P
-------	---	--------	---	---

Hereafter the above operations are repeated.

Symbol	Description
S	Start condition
Slave Address	Slave address 1000001X, 8th bit is write signal ["0"] or read signal ["1"] Slave address is set at M[2] pin (pin 89).
A, A'	Acknowledge. Generated by slave
Subaddress	Subaddress byte
Data n	Data to write to address designated by subaddress.
Data m	Data to read from address designated by subaddress
P	Stop condition

As mentioned above, the write/read operation can be executed from subaddress to subaddress continuously. When the write/read operation is executed at subaddresses discontinuously, the Acknowledge and Stop condition formats are input repeatedly after Data 0. Data can be read at subaddress 0x20 only.

The content of read register (VBID-related data) is held unless reset is instructed by the register at address 1f. The input format is shown in "READ MODE2". The equipment should return an acknowledge signal for read data.

If one of the following matters occurs, the decoder will not return "A" (Acknowledge).

- The slave address does not match.
- A non-existent subaddress is specified.
- The write attribute of a register does not match "X" (read ["1"]/write ["0"] control bit).

The input timing is shown below.

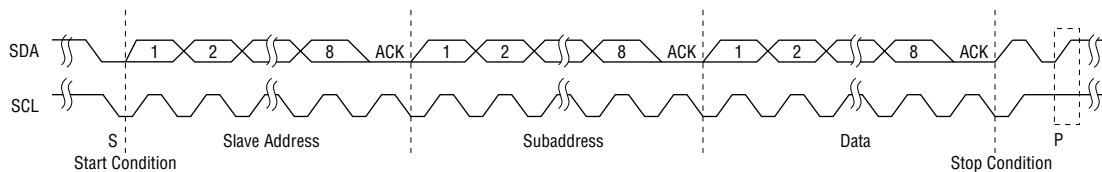

OPERATING MODE SETTING

There are two types of video mode settings.

1. External pin mode: direct setting from dedicated pins
2. Register setting mode: specification by internal register settings

These modes can be switched by the mode register MRA[0].

The reset state (default) is the external pin mode.

The following registers can be set in the external pin mode.

MRA[7:6]	Output mode	00: ITU-RBT.656 (SAV, EAV, blank processing) *01: 8 bit (YCbCr) HSYNC_L and VSYNC_L used for synchronization
		10: ITU-RBT.601 16 bit (8 bit Y, 8 bit CbCr) 11: RGB (8 bit R, 8 bit G, 8 bit B)
MRA[3:1]	Sampling mode	*000: NTSC ITU-RBT.601 13.5 MHz (27.0 MHz) 001: NTSC Square Pixel 12.272727 MHz (24.545454 MHz) 010: NTSC 4fsc 14.31818 MHz (28.63636 MHz) 100: PAL ITU-RBT.601 13.5 MHz (27.0 MHz) 101: PAL Square Pixel 14.75 MHz (29.5 MHz)

Note: 010: NTSC 4fsc cannot be set externally.

Pin Setting Example

NTSC, 27 MHz (ITU-RBT.601), Composite input, 8-bit (YCbCr) Output

Pin Name	Condition	Notes
MODE[3]	= low	0 : ITU-RBT.656 01 : 8-bit (YCbCr)
MODE[2]	= high	10 : 16-bit (Y + CbCr) 11 : RGB
MODE[1]	= low	0 : NTSC 1 : PAL
MODE[0]	= low	0 : ITU-RBT.601 1 : Square Pixel
CLKSEL	= low	0 : twice the pixel frequency 1 : pixel frequency
PLLSEL	= low	Normally set to a low level
INS[2:0]	= low	
GAINS[2:0]	= low	
TEST[2:0]	= low	
SCAN	= low	
M[2]	= low	: low = 1000001, : high = 1000011
M[1]	= low	Normally set to a low level
M[0]	= low	
SLEEP	= low	0 : normal operation 1 : sleep

INTERNAL REGISTERS

Register List

Register Function	Write /Read	Sub-address	Data byte							
			D7	D6	D5	D4	D3	D2	D1	D0
Mode Register A (MRA)	Write	0	MRA7	MRA6	MRA5	MRA4	MRA3	MRA2	MRA1	MRA0
Mode Register B (MRB)	Write	1	MRB7	MRB6	MRB5	MRB4	MRB3	MRB2	MRB1	MRB0
Mode Register C (MRC)	Write	2	MRC7	MRC6	MRC5	MRC4	MRC3	MRC2	MRC1	MRC0
Horizontal Sync Trimmer (HSYT)	Write	3	HSYT7	HSYT6	HSYT5	HSYT4	HSYT3	HSYT2	HSYT1	HSYT0
Sync Threshold Level Adjust (STHR)	Write	4	STHR7	STHR6	STHR5	STHR4	STHR3	STHR2	STHR1	STHR0
Horizontal Sync Delay (HSDL)	Write	5	HSDL7	HSDL6	HSDL5	HSDL4	HSDL3	HSDL2	HSDL1	HSDL0
Horizontal Valid Trimmer (HVALT)	Write	6	HVALID7	HVALID6	HVALID5	HVALID4	HVALID3	HVALID2	HVALID1	HVALID0
Vertical Valid Trimmer (VVALT)	Write	7	VVALID7	VVALID6	VVALID5	VVALID4	VVALID3	VVALID2	VVALID1	VVALID0
Luminance Control (LUMC)	Write	8	LUMC7	LUMC6	LUMC5	LUMC4	LUMC3	LUMC2	LUMC1	LUMC0
AGC/Pedestal Loop Filter Control (AGCLF)	Write	9	AGCLF7	AGCLF6	AGCLF5	AGCLF4	AGCLF3	AGCLF2	AGCLF1	AGCLF0
Sync Separation Level (SSEPL)	Write	A	SSEPL7	SSEPL6	SSEPL5	SSEPL4	SSEPL3	SSEPL2	SSEPL1	SSEPL0
Chrominance Control (CHRC)	Write	B	CHRC7	CHRC6	CHRC5	CHRC4	CHRC3	CHRC2	CHRC1	CHRC0
ACC Loop Filter Control (ACCLF)	Write	C	ACCLF7	ACCLF6	ACCLF5	ACCLF4	ACCLF3	ACCLF2	ACCLF1	ACCLF0
Hue Control (HUE)	Write	D	HUE7	HUE6	HUE5	HUE4	HUE3	HUE2	HUE1	HUE0
Output Phase Control for Data Y (OPCY)	Write	E	OPCY7	OPCY6	OPCY5	OPCY4	OPCY3	OPCY2	OPCY1	OPCY0
Output Phase Control for Data C (OPCC)	Write	F	OPCC7	OPCC6	OPCC5	OPCC4	OPCC3	OPCC2	OPCC1	OPCC0
Optional Mode Register (OMR)	Write	10	OMR7	OMR6	OMR5	OMR4	OMR3	OMR2	OMR1	OMR0
ADC Register (ADC1)	Write	11	ADC17	ADC16	ADC15	ADC14	ADC13	ADC12	ADC11	ADC10
ADC Register (ADC2)	Write	12	ADC27	ADC26	ADC25	ADC24	ADC23	ADC22	ADC21	ADC20
ADC Register (ADC3)	Write	13	ADC37	ADC36	ADC35	ADC34	ADC33	ADC32	ADC31	ADC30
0 Level Detect Register (ZLD)	Write	14	ZLD7	ZLD6	ZLD5	ZLD4	ZLD3	ZLD2	ZLD1	ZLD0
Y/C Separation Circuit option Register (YCSC)	Write	15	YCSC7	YCSC6	YCSC5	YCSC4	YCSC3	YCSC2	YCSC1	YCSC0
Optional Mode Register B (OMRB)	Write	16	OMRB7	OMRB6	OMRB5	OMRB4	OMRB3	OMRB2	OMRB1	OMRB0
Closed Caption Detected-1 Register (CCD1)	Write	17	CCD17	CCD16	CCD15	CCD14	CCD13	CCD12	CCD11	CCD10
Closed Caption Detected-2 Register (CCD2)	Write	18	CCD27	CCD26	CCD25	CCD24	CCD23	CCD22	CCD21	CCD20
CGMS Detected-1 Register (CGMS1)	Write	19	CGMS17	CGMS16	CGMS15	CGMS14	CGMS13	CGMS12	CGMS11	CGMS10
CGMS Detected-2 Register (CGMS2)	Write	1A	CGMS27	CGMS26	CGMS25	CGMS24	CGMS23	CGMS22	CGMS21	CGMS20
AGC Pulse Detected-1 Register (AGCD1)	Write	1B	AGCD17	AGCD16	AGCD15	AGCD14	AGCD13	AGCD12	AGCD11	AGCD10
AGC Pulse Detected-2 Register (AGCD2)	Write	1C	AGCD27	AGCD26	AGCD25	AGCD24	AGCD23	AGCD22	AGCD21	AGCD20
WSS Data Detected Register (WSSD)	Write	1D	WSSD7	WSSD6	WSSD5	WSSD4	WSSD3	WSSD2	WSSD1	WSSD0
Tri-state Control of Output-pin Register (MISC)	Write	1E	MISC7	MISC6	MISC5	MISC4	MISC3	MISC2	MISC1	MISC0
Reset Data Request for VBID Function Register (AIREG)	Write	1F	AIREG7	AIREG6	AIREG5	AIREG4	AIREG3	AIREG2	AIREG1	AIREG0

Register List (continued)

Register Function	Write /Read	Sub-address	Data byte							
			D7	D6	D5	D4	D3	D2	D1	D0
Status Register (STATUS)	Read	20	STATUS7	STATUS6	STATUS5	STATUS4	STATUS3	STATUS2	STATUS1	STATUS0
VBID Flag Register (VFLAG)	Read	21	VFLAG7	VFLAG6	VFLAG5	VFLAG4	VFLAG3	VFLAG2	VFLAG1	VFLAG0
C. C. Data Buffer Register in Odd Field (CCDO0)	Read	22	CCDO07	CCDO06	CCDO05	CCDO04	CCDO03	CCDO02	CCDO01	CCDO00
C. C. Data Buffer Register in Odd Field (CCDO1)	Read	23	CCDO17	CCDO16	CCDO15	CCDO14	CCDO13	CCDO12	CCDO11	CCDO10
C. C. Data Buffer Register in Even Field (CCDE0)	Read	24	CCDE07	CCDE06	CCDE05	CCDE04	CCDE03	CCDE02	CCDE01	CCDE00
C. C. Data Buffer Register in Even Field (CCDE1)	Read	25	CCDE17	CCDE16	CCDE15	CCDE14	CCDE13	CCDE12	CCDE11	CCDE10
CGMS Data Buffer Register in Odd Field (CGMS00)	Read	26	CGMS007	CGMS006	CGMS005	CGMS004	CGMS003	CGMS002	CGMS001	CGMS000
CGMS Data Buffer Register in Odd Field (CGMS01)	Read	27	CGMS017	CGMS016	CGMS015	CGMS014	CGMS013	CGMS012	CGMS011	CGMS010
CGMS Data Buffer Register in Odd Field (CGMS02)	Read	28	CGMS027	CGMS026	CGMS025	CGMS024	CGMS023	CGMS022	CGMS021	CGMS020
CGMS Data Buffer Register in Even Field (CGMSE0)	Read	29	CGMSE07	CGMSE06	CGMSE05	CGMSE04	CGMSE03	CGMSE02	CGMSE01	CGMSE00
CGMS Data Buffer Register in Even Field (CGMSE1)	Read	2A	CGMSE17	CGMSE16	CGMSE15	CGMSE14	CGMSE13	CGMSE12	CGMSE11	CGMSE10
CGMS Data Buffer Register in Even Field (CGMSE2)	Read	2B	CGMSE27	CGMSE26	CGMSE25	CGMSE24	CGMSE23	CGMSE22	CGMSE21	CGMSE20
WSS Data Buffer Register (WSS0)	Read	2C	WSS07	WSS06	WSS05	WSS04	WSS03	WSS02	WSS01	WSS00
WSS Data Buffer Register (WSS1)	Read	2D	WSS17	WSS16	WSS15	WSS14	WSS13	WSS12	WSS11	WSS10

Register Parameters

Registers controlled from the I²C-bus are listed below.

An asterisk (*) indicates that the register setting value is the default value.

Mode Register A (MRA) Write only <address: \$00>

Register Name	MRA[7]	MRA[6]	MRA[5]	MRA[4]	MRA[3]	MRA[2]	MRA[1]	MRA[0]
Default	0	1	0	0	0	0	0	0
Recommended Value	—	—	—	0	—	—	—	—

MRA[7:6]	Video output mode	00: ITU-RBT.656 *01: Y, C 8 bits 10: Y, C 16 bits 11: RGB 24 bits Video output mode is selected.
MRA[5]	Chroma format	*0: Offset binary 1: 2's complement
MRA[4]	Undefined	Set to 0 1: S-video input
MRA[3:1]	Input Sampling mode	*000: NTSC ITU-RBT.601 13.5 MHz 001: NTSC Square Pixel 12.272727 MHz 010: NTSC 4fsc 14.31818 MHz 100: PAL ITU-RBT.601 13.5 MHz 101: PAL Square Pixel 14.75 MHz 110, 111: Undefined Sampling rate is selected
MRA[0]	MODE[3:0] pin select	*0: External pin mode 1: Register mode

Note: Only the setting of MODE[3:0] is valid in this external pin mode.

Mode Register B (MRB) Write only <address: \$01>

Register Name	MRB[7]	MRB[6]	MRB[5]	MRB[4]	MRB[3]	MRB[2]	MRB[1]	MRB[0]
Default	0	0	0	1	0	0	0	0
Recommended Value	0	0	0	1	0	0	0	0

MRB[7:6] Synchronization mode
 *00: FIFO-1 (use internal memory)
 01: FIFO-2 (use internal memory)
 10: FM-1 (use external memory, external control)
 11: FM-2 (use external memory, control signals supplied from M[7:4])

Note: In the FIFO-1 mode, the number of pixels per 1H is output at the standard setting value. In the FIFO-2 mode, the number of pixels per 1H is fixed in accordance with an input H period and output. In the FM-1 and FM-2 modes, a decoded result is output without any changes according to the SYNC signal. A field memory is required externally to output the fixed number of pixels in those modes. In the FM-2 mode, a field memory control signal is output from the pin M[7:4].

MRB[5] Color killer mode
 *0: Auto color killer (Chrominance signal level is set to "0" if the color burst level is below the specified value.)
 *1: Forced color killer (Chrominance signal level is forced to "0".)

MRB[4] Blue Back
 0: OFF (Video signal is demodulated and output regardless of synchronization detection.)
 *1: AUTO (Blue Back is output when synchronization is not detected.)

MRB[3:2] Clamp mode
 *00: Analog clamp
 01: Analog, Digital hybrid clamp
 10: Digital clamp (HSY clamp)
 11: Undefined
 Clamp mode is selected.

MRB[1:0] Y/C separation mode
 *00: Adaptive comb filter (Correlation of 3 lines is monitored and operating mode is selected.)
 01: Non-adaptive comb filter (Operating mode is always fixed.)
 10: Use trap filter. (Comb filter is not used.)
 11: Undefined

Note: Adaptive comb filter 2/3-line comb filter for NTSC
 Comb filter/trap filter for PAL
 Non-adaptive comb filter 3-line comb filter for NTSC
 2-line cosine comb filter for PAL

Mode Register C (MRC) Write only <address: \$02>

Register Name	MRC[7]	MRC[6]	MRC[5]	MRC[4]	MRC[3]	MRC[2]	MRC[1]	MRC[0]
Default	1	0	0	0	0	0	0	0
Recommended Value	1	0	—	0	—	—	0	0

MRC[7] NTSC/PAL auto select 0: Fix
*1: Auto

Note: This register decides automatically when the sampling frequency of input signals is ITU-RBT.601.

MRC[6] Pixel alignment *0: Use pixel position compensating circuit.
1: Do not use pixel position compensating circuit.

MRC[5] Pixel sampling rate *0: (4:2:2)
1: (4:1:1)

MRC[4] Data-pass control *0: Use DECIMATOR at 2x sampling.
1: Do not use DECIMATOR.

Note: This register is valid when a 2x clock (27 MHz) is input.

MRC[3] SAV, EAV V-status *0: During blanking, V = 1
1: During blanking, while VBI data is not detected, V = 1

MRC[2] RGB output level *0: 0 to 255
1: 16 to 235

MRC[1:0] Undefined Set to 0

Horizontal Sync Trimmer (HSYT) Write only <address: \$03>

Register Name	HSYT[7]	HSYT[6]	HSYT[5]	HSYT[4]	HSYT[3]	HSYT[2]	HSYT[1]	HSYT[0]
Default	0	0	0	0	0	0	0	0
Recommended Value	0	0	0	0	0	0	0	0

HSYT[7:4] HSY start trimmer (× 8 pixels) \$C to \$B (*\$0): -4 to +11 (-32 to +88 pixels)
HSYT[3:0] HSY stop trimmer (× 8 pixels) \$C to \$B (*\$0): -4 to +11 (-32 to +88 pixels)

Note: The HSYT signal provides the clamp timing to the A/D converter during digital clamp or hybrid clamp mode. Because this signal can move to the pedestal position, the pedestal clamp can be used. However, this signal can not be observed from outside.

Sync. Threshold level adjust (STHR) Write only <address: \$04>

Register Name	STHR[7]	STHR[6]	STHR[5]	STHR[4]	STHR[3]	STHR[2]	STHR[1]	STHR[0]
Default	0	0	0	1	1	1	1	0
Recommended Value	0	0	1	1	0	1	1	1

STHR[7] Auto Sync. depth *0: Register control
1: Automatic control

Note: The automatic control mode is a mode in which HSYNC is detected by automatically tracking the input sync level and varying the threshold level. The register control mode is a mode in which HSYNC is detected by the threshold level designated by STHR[6:0]. The MSM7664, which differs from its predecessor the MSM7662 in the sync detection technique, enhances the synchronous detection for signals including noise in the weak electrical field. However the margin for the sync detection is slightly worse.

STHR[6:0] Sync. depth 0x0: 0 to *0xIE: 30 to 0x7F: 127

Note: The threshold level of sync signal detection is adjusted using this register. The unit of the number of here is one determined taking 80IRE as the reference value, which is twice the pedestal value 40IRE of the standard signal. For example, the default setting of 0x37 is 55 in decimal and becomes 27.5IRE when converted with respect to 40IRE.

Horizontal Sync Delay (HSDL) Write only <address: \$05>

Register Name	HSDL[7]	HSDL[6]	HSDL[5]	HSDL[4]	HSDL[3]	HSDL[2]	HSDL[1]	HSDL[0]
Default	0	0	0	0	0	0	0	0
Recommended Value	0	0	0	0	0	0	0	0

HSDL[7:0] HSYNC_L delay trimmer ($\times 1$ pixel)
\$80 to \$7F (*\$00): -128 to +127 (-128 to +127 pixels)

Note: The HSYNC_L sync signal output position is adjusted.

Horizontal Valid Trimmer (HVALT) Write only <address: \$06>

Register Name	HVALT [7]	HVALT [6]	HVALT [5]	HVALT [4]	HVALT [3]	HVALT [2]	HVALT [1]	HVALT [0]
Default	0	0	0	0	0	0	0	0
Recommended Value	0	0	0	0	0	0	0	0

HVALT[7:4] HVALID start trimmer ($\times 2$ pixels) \$8 to \$7 (*\$0): -8 to +7 (-16 to +14 pixels)

HVALT[3:0] HVALID stop trimmer ($\times 2$ pixels) \$8 to \$7 (*\$0): -8 to +7 (-16 to +14 pixels)

Note: HVALID start position and end position are changed.

Vertical Valid Trimmer (VVALT) Write only <address: \$07>

Register Name	VVALT [7]	VVALT [6]	VVALT [5]	VVALT [4]	VVALT [3]	VVALT [2]	VVALT [1]	VVALT [0]
Default	0	0	0	0	0	0	0	0
Recommended Value	0	0	0	0	0	0	0	0

VVALT[7:4] VVALID start trimmer ($\times 1$ line) \$8 to \$7 (*\$0): -8 to +7

VVALT[3:0] VVALID stop trimmer ($\times 1$ line) \$8 to \$7 (*\$0): -8 to +7

Note: VVALID start position and end position are changed.

Luminance Control (LUMC) Write only <address: \$08>

Register Name	LUMC[7]	LUMC[6]	LUMC[5]	LUMC[4]	LUMC[3]	LUMC[2]	LUMC[1]	LUMC[0]
Default	0	0	0	0	0	0	0	0
Recommended Value	0	0	0	0	0	0	0	0

LUMC[7] Output level limiter *0: OFF
1: ON

Note: Control range while limiter is ON: 16 to 235

LUMC[6] Use of prefilter *0: Do not use prefilter.
1: Use prefilter.

LUMC[5:4] Aperture bandpass select *00: range0 (middle)
01: range1
10: range2
11: range3 (high)

LUMC[3:2] Coring range select *00: coring off
01: ± 4 LSB
10: ± 5 LSB
11: ± 7 LSB

LUMC[1:0] Aperture filter weighting factor
*00: 0.00
01: 0.25
10: 0.75
11: 1.50

Note: These registers are used for contour compensation.

AGC/Pedestal Loop filter control (AGCLF)

Write only <address: \$09>

Register Name	AGCLF [7]	AGCLF [6]	AGCLF [5]	AGCLF [4]	AGCLF [3]	AGCLF [2]	AGCLF [1]	AGCLF [0]
Default	0	1	0	0	0	0	0	0
Recommended Value	0	1	0	0	0	0	0	0

AGCLF[7:6] AGC loop filter time constant

00: slow
 *01: medium
 10: fast
 11: MGC mode

Note: The AGC convergence time is determined. These registers converge about 4 times faster by slow-medium-fast steps. In the MGC mode, the amplification is determined by reference level. Set the SSEPL[7] value to a 0 when the MGC mode is used.

AGCLF[5:0] AGC reference level \$20 to \$1F (*\$00): -32 to +31

Sync separation level (SSEPL)

Write only <address: \$0A>

Register Name	SSEPL [7]	SSEPL [6]	SSEPL [5]	SSEPL [4]	SSEPL [3]	SSEPL [2]	SSEPL [1]	SSEPL [0]
Default	0	0	0	0	0	0	0	0
Recommended Value	0	0	0	0	0	0	0	0

SSEPL[7] Pedestal Clamp on/off

*0: Do not use pedestal clamp.
 1: Use pedestal clamp (AGC stops operating).

SSEPL[6:0] Sync. separation level

\$40 to \$3F (*\$00): -64 to +63

Note: The default setting outputs the pedestal position as a black level.

Chrominance Control (CHRC) Write only <address: \$0B>

Register Name	CHRC[7]	CHRC[6]	CHRC[5]	CHRC[4]	CHRC[3]	CHRC[2]	CHRC[1]	CHRC[0]
Default	0	0	0	0	0	1	0	1
Recommended Value	0	0	0	0	0	1	0	1

CHRC[7] Color-killer mode *0: Preset always the color killer to OFF at the top of field.

1: Maintain the previous field status when the device is in an out-of-synchronization state at the top of field.

CHRC[6:4] U, V-filter threshold Setting of U/V averaging processing

*000: Do not do averaging.

001: Level difference 4

010: Level difference 8

011: Level difference 12

100: Level difference 16

101: Level difference 20

110: Level difference 24

111: Always do averaging.

Note: When in the output mode, U and V data can be averaged on the preceding and following lines. At that time, when the level difference is set, averaging operation is performed on each line taking the level as the threshold.

CHRC[3] C-Output level limiter *0: OFF
1: ON

Note: Control range while limiter is ON: 16 to 224

CHRC[2] Chroma bandpass filter 0: OFF
*1: ON

CHRC[1:0] Color kill threshold factor 00: 0.500 color burst level
*01: 0.250 color burst level
10: 0.125 color burst level
11: Color killer off

Note: The color killer decision level is selected based upon color burst ratio.

ACC Loop filter control (ACCLF) Write only <address: \$0C>

Register Name	ACCLF [7]	ACCLF [6]	ACCLF [5]	ACCLF [4]	ACCLF [3]	ACCLF [2]	ACCLF [1]	ACCLF [0]
Default	0	0	1	0	0	0	0	0
Recommended Value	0	0	1	0	0	0	0	0

ACCLF[7] Undefined Set to 0
 ACCLF[6:5] ACC loop filter time constant
 00: fast2
 *01: medium
 10: fast
 11: MCC mode

Note: The ACC convergence time is determined. These registers converge about 4 times faster by medium-fast-fast2 steps. In the MCC mode, the amplification is determined by reference level.

ACCLF[4:0] ACC reference level \$10 to \$0F (*\$00): -16 to +15

Hue control (HUE) Write only <address: \$0D>

Register Name	HUE[7]	HUE[6]	HUE[5]	HUE[4]	HUE[3]	HUE[2]	HUE[1]	HUE[0]
Default	0	0	0	0	0	0	0	0
Recommended Value	0	0	0	0	0	0	0	0

HUE[7:0] Hue control \$80 to \$7F (*\$00): -180 to +178.6 degrees

Note: The phase is controlled. It changes about 1.4 degrees per bit.

Output phase control for data Y (OPCY)

Write only <address: \$0E>

Register Name	OPCY[7]	OPCY[6]	OPCY[5]	OPCY[4]	OPCY[3]	OPCY[2]	OPCY[1]	OPCY[0]
Default	0	0	0	0	0	0	0	0
Recommended Value	0	0	0	0	0	0	0	0

OPCY[7:2] Undefined Set to 0
 OPCY[1:0] Output phase control for data Y
 *00: normal
 01: forward 1 clock
 10: backward 2 clock
 11: backward 1 clock

Note: The output phase of data Y is controlled.

Output phase control for data C (OPCC)

Write only <address: \$0F>

Register Name	OPCC[7]	OPCC[6]	OPCC[5]	OPCC[4]	OPCC[3]	OPCC[2]	OPCC[1]	OPCC[0]
Default	0	0	0	0	0	0	0	0
Recommended Value	0	0	0	0	0	0	0	0

OPCC[7] Undefined Set to 0

OPCC[6] Anti-noise circuit *0: OFF
1: ON

Note: The stability is increased when this setting is made ON at the time of decoding signals under weak electric fields.

OPCC[5:2] Undefined Set to 0

OPCC[1:0] Output phase control for data C
*00: normal
01: forward 1 clock
10: backward 2 clock
11: backward 1 clock

Note: The output phase of data C is controlled.

Optional Mode Register (OMR)

Write only <address: \$10>

Register Name	OMR[7]	OMR[6]	OMR[5]	OMR[4]	OMR[3]	OMR[2]	OMR[1]	OMR[0]
Default	0	0	0	0	0	0	0	0
Recommended Value	1	1	0	0	0	0	0	0

OMR[7] HSYNC output timing select *0: HSYNC output signal is detected near sync threshold and sync tip.
1: HSYNC output signal is detected at sync threshold setting position.

Note: When the HSYNC output signal is detected at sync threshold setting position, it is hardly affected by noise.

OMR[6] VSYNC output timing select *0: VSYNC_L is synchronized to HSYNC_L and then output
1: VSYNC_L is output when a VSYNC input signal is detected.

Note: When a non-standard signal is decoded, the output is stabilized after the VSYNC_L input signal is detected (setting 1).

OMR[5:3] Undefined Set to 0

OMR[2] Hi-Z output in SLEEP mode
*0: Active
1: Hi-Z

Note: This register selects either normal or Hi-Z as the output pin status in SLEEP mode.

OMR[1] Status2 output mode *0: NTSC/PAL identification
1: HLOCK sync detectionOMR[0] Status3 output mode *0: TV/VCR identification
1: CSYNC

Note: OMR[1:0] correspond to the STATUS[2:3] output of output pins.

ADC register 1 (ADC1) Write only <address: \$11>

Register Name	ADC1[7]	ADC1[6]	ADC1[5]	ADC1[4]	ADC1[3]	ADC1[2]	ADC1[1]	ADC1[0]
Default	0	0	0	0	0	0	0	0
Recommended Value	0	0	0	0	0	—	—	—

ADC1[7]	Video amp select	*0: Use 1: Do not use
ADC1[6]	Undefined	Set to 0
ADC1[5:4]	Clamp current select	*00: 0.10 01: 0.05 10: 0.30 11: 0.80
ADC1[3]	Undefined	Set to 0
ADC1[2:0]	ADC input select	*000: ADI-VIN1 (composite-1) 001: ADI-VIN2 (composite-2) 010: ADI-VIN3 (composite-3) 011: ADI-VIN4 (composite-4) 100: ADI-VIN5 (composite-5) 101: ADI-VIN1 (Y-1), AD2-VIN5 (C-1) 110: ADI-VIN2 (Y-1), AD2-VIN6 (C-1) 111: Prohibited setting (ADC enters sleep state)

Note: When the LSI is used in Composite video mode, input clocks or do resetting after setting S-video mode (101), (110) before setting Composite video mode.

ADC register 2 (ADC2) Write only <address: \$12>

Register Name	ADC2[7]	ADC2[6]	ADC2[5]	ADC2[4]	ADC2[3]	ADC2[2]	ADC2[1]	ADC2[0]
Default	1	0	0	1	1	1	1	0
Recommended Value	0	0	0	1	1	1	1	0

ADC2[7]	ADC gain control mode select	0: manual *1: auto
ADC2[6:4]	ADC gain manual select	000: 1.00 *001: 1.35 010: 1.75 011: 2.30 100: 3.00 101: 3.80 110: 5.00 111: Undefined
ADC2[3]	ADC initialize condition gain select	0: not initialize *1: initialize
ADC2[2]	Undefined	Set to 0
ADC2[1:0]	ADC gain control and stage select	00: 2nd change end 01: 3rd change end *10: 3rd change loop 11: Undefined

ADC register 3 (ADC3) Write only <address: \$13>

Register Name	ADC3[7]	ADC3[6]	ADC3[5]	ADC3[4]	ADC3[3]	ADC3[2]	ADC3[1]	ADC3[0]
Default	0	0	1	0	0	0	1	0
Recommended Value	0	0	1	0	0	0	1	0

ADC3[7] Undefined Set to 0

ADC3[6:4] ADC gain control margin level select
 000: 10 mV
 001: 20 mV
 *010: 40 mV
 011: 80 mV
 100: 160 mV
 101, 110, 111: Undefined

ADC3[3] Undefined Set to 0

ADC3[2:0] ADC gain control line select
 000: 1 line
 001: 2 lines
 *010: 4 lines
 011: 8 lines
 100: 16 lines
 101, 110, 111: Undefined

Note: These registers determine the analog gain control decision level. The stability can be obtained from higher values.

0 level detect register (ZLD) Write only <address: \$14>

Register Name	ZLD[7]	ZLD[6]	ZLD[5]	ZLD[4]	ZLD[3]	ZLD[2]	ZLD[1]	ZLD[0]
Default	0	0	0	0	0	0	1	0
Recommended Value	0	0	0	0	0	0	1	0

ZLD[7:3] Undefined Set to 0

ZLD[2:0] 0 level detect width (× 8 pixels)
 000: Undefined
 001: 8 pixels
 *010: 16 pixels
 011: 24 pixels
 100: 32 pixels
 101: 40 pixels
 110: 48 pixels
 111: 56 pixels

Note: These registers decide the continuance of sync tip level and its result is reflected in AGC gain. The stability can be obtained from higher values.

Y/C Separation Circuit option register (YCSC)

Write only <address: \$15>

Register Name	YCSC[7]	YCSC[6]	YCSC[5]	YCSC[4]	YCSC[3]	YCSC[2]	YCSC[1]	YCSC[0]
Default	0	0	0	0	0	0	0	0
Recommended Value	0	0	0	0	0	0	0	0

YCSC[7:3] Undefined Set to 0

YCSC[2:0] Adaptive transition comb-filter threshold factor

\$4: -4 to *\$0: 0 to \$3: +3

Note: The setting in this register becomes valid when the adaptive filter or the non-adaptive filter for PAL is selected. In the case of the adaptive filter, it is easier to operate it as a comb filter irrespective of the correlation between lines in the positive direction, and in the negative direction, it is easier to operate it as a trap filter irrespective of the correlation between the lines. Further, in the case of the non-adaptive filter, the operation is fixed as a comb filter in the positive direction and as a trap filter in the negative direction, and averaging is done in the intermediate position.

Optional Mode Register B (OMRB) Write only <address: \$16>

Register Name	OMRB[7]	OMRB[6]	OMRB[5]	OMRB[4]	OMRB[3]	OMRB[2]	OMRB[1]	OMRB[0]
Default	0	0	0	0	0	0	0	0
Recommended Value	0	0	0	0	0	0	0	0

OMRB[7:6] Undefined Set to 0

OMRB[5] Color lock feedback mode

*0: Single-sided feedback

1: Double-sided feedback

Note: These settings select whether the frequency shift during sub-carrier tracking is done for the even-numbered lines and odd-numbered lines separately or for both lines. Although this normally has no effect, if the frequency shift is large when the video is switched, it is likely that the stability increases if single-sided feedback is selected. This is valid only during hte PAL video mode.

OMRB[4] No synchronous free running

*0: 30H free running mode

1: 6H free running mode

Note: This selects the free running duration when synchronization is not detected.

OMRB[3:0] Burst calculation range

\$8: -8 to *\$0: 0 to \$7: +7

Note: This adjusts the burst summation position. This is valid when the color burst signal in the input is distorted.

Closed Caption detected-1 register (CCD1)

Write only <address: \$17>

Register Name	CCD1[7]	CCD1[6]	CCD1[5]	CCD1[4]	CCD1[3]	CCD1[2]	CCD1[1]	CCD1[0]
Default	0	0	0	0	0	0	0	0
Recommended Value	0	0	0	0	0	0	0	0

CCD1[7:5] C.C. data detected level \$4 to \$3 (*\$0): -4 to +3
 CCD1[4:0] C.C data mounted line \$1f to \$0f (*\$0): -16 to +15
 ODD field NTSC: 5 to 36 (*21)
 PAL: 7 to 38 (*23)

Closed Caption detected-2 register (CCD2)

Write only <address: \$18>

Register Name	CCD2[7]	CCD2[6]	CCD2[5]	CCD2[4]	CCD2[3]	CCD2[2]	CCD2[1]	CCD2[0]
Default	0	0	0	0	0	0	0	0
Recommended Value	0	0	0	0	0	0	0	0

CCD2[7:5] Undefined Set to 0
 CCD2[4:0] C.C data mounted line \$1f to \$0f (*\$0): -16 to +15
 EVEN field NTSC: 5 to 36 (*21)
 PAL: 7 to 38 (*23)

CGMS detected-1 register (CGMS1) Write only <address: \$19>

Register Name	CGMS1 [7]	CGMS1 [6]	CGMS1 [5]	CGMS1 [4]	CGMS1 [3]	CGMS1 [2]	CGMS1 [1]	CGMS1 [0]
Default	0	0	0	0	0	0	0	0
Recommended Value	0	0	0	0	0	0	0	0

CGMS1[7:5] CGMS data detected level \$4 to \$3 (*\$0): -4 to +3
 CGMS1[4:0] CGMS data mounted line \$1f to \$0f (*\$0): -16 to +15
 ODD field NTSC: 5 to 36 (*21) NTSC only

CGMS detected-2 register (CGMS2) Write only <address: \$1A>

Register Name	CGMS2 [7]	CGMS2 [6]	CGMS2 [5]	CGMS2 [4]	CGMS2 [3]	CGMS2 [2]	CGMS2 [1]	CGMS2 [0]
Default	0	0	0	0	0	0	0	0
Recommended Value	0	0	0	0	0	0	0	0

CGMS2[7:5] Undefined Set to 0
 CGMS2[4:0] CGMS data mounted line \$1f to \$0f (*\$0): -16 to +15
 EVEN field NTSC: 5 to 36 (*21) NTSC only

AGC pulse detected-1 register (AGCD1)

Write only <address: \$1B>

Register Name	AGCD1 [7]	AGCD1 [6]	AGCD1 [5]	AGCD1 [4]	AGCD1 [3]	AGCD1 [2]	AGCD1 [1]	AGCD1 [0]
Default	0	0	0	0	0	0	0	0
Recommended Value	0	0	0	0	0	0	0	0

AGCD[7:5] AGC pulse detected level \$4 to \$3 (*\$0): -4 to +3
 AGCD[4:0] AGC pulse mounted line \$1f to \$0f (*\$0): -16 to +15
 ODD field NTSC: 5 to 36 (*21)
 PAL: 7 to 38 (*23)

AGC pulse detected-2 register (AGCD2)

Write only <address: \$1C>

Register Name	AGCD2 [7]	AGCD2 [6]	AGCD2 [5]	AGCD2 [4]	AGCD2 [3]	AGCD2 [2]	AGCD2 [1]	AGCD2 [0]
Default	0	0	0	0	0	0	0	0
Recommended Value	0	0	0	0	0	0	0	0

AGCD2[7] Undefined Set to 0
 AGCD2[6] Sampling pulse select
 *0: 3 pulse
 1: 1 pulse
 AGCD2[5] Data change point select
 *0: SYNC (rise/fall)
 1: SYNC (fall/rise) & AGC (rise)
 AGCD2[4:0] EVEN pulse mounted line \$1f to \$0f (*\$0): -16 to +15
 ODD field NTSC: 5 to 36 (*21)
 PAL: 7 to 38 (*23)

WSS data detected register (WSSD) Write only <address: \$1D>

Register Name	WSSD[7]	WSSD[6]	WSSD[5]	WSSD[4]	WSSD[3]	WSSD[2]	WSSD[1]	WSSD[0]
Default	0	0	0	0	0	0	0	0
Recommended Value	0	0	0	0	0	0	0	0

WSSD[7:5] WSS data detected level \$4 to \$3 (*\$0): -4 to +3
 WSSD[4:0] WSS data mounted line \$1f to \$0f (*\$0): -16 to +15
 PAL: 7 to 38 (*23) PAL only

Tri-state control of output-pin register (MISC)

Write only <address: \$1E>

Register Name	MISC[7]	MISC[6]	MISC[5]	MISC[4]	MISC[3]	MISC[2]	MISC[1]	MISC[0]
Default	0	0	0	0	0	0	0	0
Recommended Value	0	0	0	0	0	0	0	0

MISC[7:2] Undefined Set to 0
 MISC[1:0] Tri-state control of output pin
 *00: Output enable
 01: All data outputs are Hi-Z.
 10: All output pins are Hi-Z.
 11: Undefined

Reset data request for VBID function register (AIREG)

Write only <address: \$1F>

Register Name	AIREG[7]	AIREG[6]	AIREG[5]	AIREG[4]	AIREG[3]	AIREG[2]	AIREG[1]	AIREG[0]
Default	0	0	0	0	0	0	0	0
Recommended Value	—	—	—	—	—	—	—	—

AIREG[7] Reset request for Color-stripe 1: Flag reset
 AIREG[6] Reset request for C.C data (odd field) 1: Flag reset
 AIREG[5] Reset request for C.C data (even field) 1: Flag reset
 AIREG[4] Reset request for CGMS data (odd field) 1: Flag reset
 AIREG[3] Reset request for CGMS data (even field) 1: Flag reset
 AIREG[2] Reset request for AGC (odd field) 1: Flag reset
 AIREG[1] Reset request for AGC (even field) 1: Flag reset
 AIREG[0] Reset request for WSS data 1: Flag reset

Note: Whether or not the above-described data exists is stored in the decoder. These results can be read from I²C-bus at subaddress \$21. However, the stored contents cannot be erased unless an instruction is given by this register.

An example of VBID module read sequence is shown below.

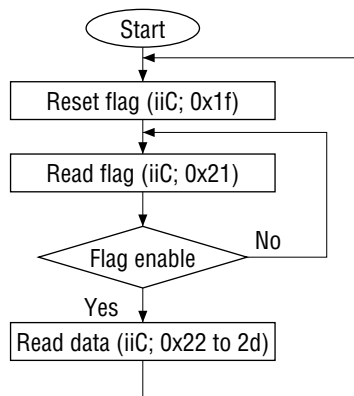

Status register (STATUS) Read only <address: \$20>

Register Name	STATUS [7]	STATUS [6]	STATUS [5]	STATUS [4]	STATUS [3]	STATUS [2]	STATUS [1]	STATUS [0]
Default	—	—	—	—	—	—	—	—
Recommended Value	—	—	—	—	—	—	—	—

STATUS[7:5] Undefined No setting
STATUS[4] VBI interval multiplex signal detection
0: Non-detection, 1: Detection
STATUS[3] HLOCK sync detection 0: Non-detection, 1: Detection
STATUS[2] NTSC/PAL identification 0: NTSC, 1: PAL
STATUS[1] FIFO1/FIFO2 identification Mode Register B (bit 6)
0: FIFO1, 1: FIFO2
STATUS[0] FIFO overflow detection 0: Non-detection, 1: Detection

VBID flag register (VFLAG) Read only <address: \$21>

Register Name	VFLAG [7]	VFLAG [6]	VFLAG [5]	VFLAG [4]	VFLAG [3]	VFLAG [2]	VFLAG [1]	VFLAG [0]
Default	—	—	—	—	—	—	—	—
Recommended Value	—	—	—	—	—	—	—	—

VFLAG[7] Color-stripe detect
VFLAG[6] C.C. data ready (odd field)
VFLAG[5] C.C. data ready (even field)
VFLAG[4] CGMS data ready (odd field)
VFLAG[3] CGMS data ready (even field)
VFLAG[2] AGC detect (odd field)
VFLAG[1] AGC detect (even field)
VFLAG[0] WSS data ready

C.C. data buffer register in odd field (CCDO0)

Read only <address: \$22>

Register Name	CCDO0 [7]	CCDO0 [6]	CCDO0 [5]	CCDO0 [4]	CCDO0 [3]	CCDO0 [2]	CCDO0 [1]	CCDO0 [0]
Default	—	—	—	—	—	—	—	—
Recommended Value	—	—	—	—	—	—	—	—

CCDO0[7:0] Bits 7 to 0 of C.C. data in odd field

C.C. data buffer register in odd field (CCDO1)

Read only <address: \$23>

Register Name	CCDO1 [7]	CCDO1 [6]	CCDO1 [5]	CCDO1 [4]	CCDO1 [3]	CCDO1 [2]	CCDO1 [1]	CCDO1 [0]
Default	—	—	—	—	—	—	—	—
Recommended Value	—	—	—	—	—	—	—	—

CCDO1[7:0] Bits 15 to 8 of C.C. data in odd field

C.C. data buffer register in even field (CCDE0)

Read only <address: \$24>

Register Name	CCDE0 [7]	CCDE0 [6]	CCDE0 [5]	CCDE0 [4]	CCDE0 [3]	CCDE0 [2]	CCDE0 [1]	CCDE0 [0]
Default	—	—	—	—	—	—	—	—
Recommended Value	—	—	—	—	—	—	—	—

CCDE0[7:0] Bits 7 to 0 of C.C. data in odd field

C.C. data buffer register in even field (CCDE1)

Read only <address: \$25>

Register Name	CCDE1 [7]	CCDE1 [6]	CCDE1 [5]	CCDE1 [4]	CCDE1 [3]	CCDE1 [2]	CCDE1 [1]	CCDE1 [0]
Default	—	—	—	—	—	—	—	—
Recommended Value	—	—	—	—	—	—	—	—

CCDE1[7:0] Bits 15 to 8 of C.C. data in odd field

CGMS data buffer register in odd field (CGMSO0)

Read only <address: \$26>

Register Name	CGMSO0 [7]	CGMSO0 [6]	CGMSO0 [5]	CGMSO0 [4]	CGMSO0 [3]	CGMSO0 [2]	CGMSO0 [1]	CGMSO0 [0]
Default	—	—	—	—	—	—	—	—
Recommended Value	—	—	—	—	—	—	—	—

CGMSO0[7:0] Bits 7 to 0 of CGMS data in odd field

CGMS data buffer register in odd field (CGMSO1)

Read only <address: \$27>

Register Name	CGMSO1 [7]	CGMSO1 [6]	CGMSO1 [5]	CGMSO1 [4]	CGMSO1 [3]	CGMSO1 [2]	CGMSO1 [1]	CGMSO1 [0]
Default	—	—	—	—	—	—	—	—
Recommended Value	—	—	—	—	—	—	—	—

CGMSO1[7:0] Bits 15 to 8 of CGMS data in odd field

CGMS data buffer register in odd field (CGMSO2)

Read only <address: \$28>

Register Name	CGMSO2 [7]	CGMSO2 [6]	CGMSO2 [5]	CGMSO2 [4]	CGMSO2 [3]	CGMSO2 [2]	CGMSO2 [1]	CGMSO2 [0]
Default	—	—	—	—	—	—	—	—
Recommended Value	—	—	—	—	—	—	—	—

CGMSO2[7:4] Undefined

CGMSO2[3:0] Bits 19 to 16 of CGMS data in odd field

CGMS data buffer register in even field (CGMSE0)

Read only <address: \$29>

Register Name	CGMSE0 [7]	CGMSE0 [6]	CGMSE0 [5]	CGMSE0 [4]	CGMSE0 [3]	CGMSE0 [2]	CGMSE0 [1]	CGMSE0 [0]
Default	—	—	—	—	—	—	—	—
Recommended Value	—	—	—	—	—	—	—	—

CGMSE0[7:0] Bits 7 to 0 of CGMS data in even field

CGMS data buffer register in even field (CGMSE1)

Read only <address: \$2A>

Register Name	CGMSE1 [7]	CGMSE1 [6]	CGMSE1 [5]	CGMSE1 [4]	CGMSE1 [3]	CGMSE1 [2]	CGMSE1 [1]	CGMSE1 [0]
Default	—	—	—	—	—	—	—	—
Recommended Value	—	—	—	—	—	—	—	—

CGMSE1[7:0] Bits 15 to 8 of CGMS data in even field

CGMS data buffer register in even field (CGMSE2)

Read only <address: \$2B>

Register Name	CGMSE2 [7]	CGMSE2 [6]	CGMSE2 [5]	CGMSE2 [4]	CGMSE2 [3]	CGMSE2 [2]	CGMSE2 [1]	CGMSE2 [0]
Default	—	—	—	—	—	—	—	—
Recommended Value	—	—	—	—	—	—	—	—

CGMSE2[7:4] Undefined

CGMSE2[3:0] Bits 19 to 16 of CGMS data in even field

WSS data buffer register (WSS0) Read only <address: \$2C>

Register Name	WSS0[7]	WSS0[6]	WSS0[5]	WSS0[4]	WSS0[3]	WSS0[2]	WSS0[1]	WSS0[0]
Default	—	—	—	—	—	—	—	—
Recommended Value	—	—	—	—	—	—	—	—

WSS0[7:0] Bits 7 to 0 of WSS data

WSS data buffer register (WSS1) Read only <address: \$2D>

Register Name	WSS1[7]	WSS1[6]	WSS1[5]	WSS1[4]	WSS1[3]	WSS1[2]	WSS1[1]	WSS1[0]
Default	—	—	—	—	—	—	—	—
Recommended Value	—	—	—	—	—	—	—	—

WSS1[7:5] Undefined

WSS1[4:0] Bits 13 to 8 of WSS data

Output Pin Control Table

Output Mode	MODE[3:2] or MRA[7:6]*1	SLEEP	OMR[2]	MISC[1:0]	Hi-Z PIN
ITU-RBT.656	00	0 (NORMAL OPERATION)	0 or 1	00	C[7:0], B[7:0]
ITU-RBT.656	00	0 (NORMAL OPERATION)	0 or 1	01	Y[7:0], C[7:0], B[7:0], M[7:3]
ITU-RBT.656	00	0 (NORMAL OPERATION)	0 or 1	10	*2
ITU-RBT.656	00	0 (NORMAL OPERATION)	0 or 1	11	Undefined
ITU-RBT.656	00	1 (SLEEP)	0	00	C[7:0], B[7:0]
ITU-RBT.656	00	1 (SLEEP)	0	01	C[7:0], B[7:0]
ITU-RBT.656	00	1 (SLEEP)	0	10	C[7:0], B[7:0]
ITU-RBT.656	00	1 (SLEEP)	0	11	C[7:0], B[7:0]
ITU-RBT.656	00	1 (SLEEP)	1	All	*2
8-bit YCbCr	01	0 (NORMAL OPERATION)	0 or 1	00	C[7:0], B[7:0]
8-bit YCbCr	01	0 (NORMAL OPERATION)	0 or 1	01	Y[7:0], C[7:0], B[7:0], M[7:3]
8-bit YCbCr	01	0 (NORMAL OPERATION)	0 or 1	10	*2
8-bit YCbCr	01	0 (NORMAL OPERATION)	0 or 1	11	Undefined
8-bit YCbCr	01	1 (SLEEP)	0	00	C[7:0], B[7:0]
8-bit YCbCr	01	1 (SLEEP)	0	01	C[7:0], B[7:0]
8-bit YCbCr	01	1 (SLEEP)	0	10	C[7:0], B[7:0]
8-bit YCbCr	01	1 (SLEEP)	0	11	C[7:0], B[7:0]
8-bit YCbCr	01	1 (SLEEP)	1	All	*2
16-bit YCbCr	10	0 (NORMAL OPERATION)	0 or 1	00	C[7:0], B[7:0]
16-bit YCbCr	10	0 (NORMAL OPERATION)	0 or 1	01	Y[7:0], C[7:0], B[7:0], M[7:3]
16-bit YCbCr	10	0 (NORMAL OPERATION)	0 or 1	10	*2
16-bit YCbCr	10	0 (NORMAL OPERATION)	0 or 1	11	Undefined
16-bit YCbCr	10	1 (SLEEP)	0	00	B[7:0]
16-bit YCbCr	10	1 (SLEEP)	0	01	B[7:0]
16-bit YCbCr	10	1 (SLEEP)	0	10	B[7:0]
16-bit YCbCr	10	1 (SLEEP)	0	11	B[7:0]
16-bit YCbCr	10	1 (SLEEP)	1	All	*2
24-bit RGB	11	0 (NORMAL OPERATION)	0 or 1	00	None
24-bit RGB	11	0 (NORMAL OPERATION)	0 or 1	01	Y[7:0], C[7:0], B[7:0], M[7:3]
24-bit RGB	11	0 (NORMAL OPERATION)	0 or 1	10	*2
24-bit RGB	11	0 (NORMAL OPERATION)	0 or 1	11	Undefined
24-bit RGB	11	1 (SLEEP)	0	00	None
24-bit RGB	11	1 (SLEEP)	0	01	None
24-bit RGB	11	1 (SLEEP)	0	10	None
24-bit RGB	11	1 (SLEEP)	0	11	None
24-bit RGB	11	1 (SLEEP)	1	All	*2

*1) MRA[7:6] are valid when in Internal Register Mode.

*2) Y[7:0], C[7:0], B[7:0], M[7:3], HSYNC_L, VSYNC_L, HVALID, VVALID, STATUS[3:1] Pins other than the pins defined as Hi-Z PIN are active.

Relationship between Register Setting Value and Adjusted Value

Horizontal Sync Trimmer

Position adjustment of sync tip clamp timing signal

HSYT [7:4] :Adjusting the starting position

Register Setting Value (0x)	C	D	E	F	0*	1	2	3	4	5	6	7	8	9	A	B
Adjusted Value (Pixel)	-32	-24	-16	-8	0	+8	+16	+24	+32	+40	+48	+56	+64	+72	+80	+88

HSYT [3:0] :Adjusting the end position

Register Setting Value (0x)	C	D	E	F	0*	1	2	3	4	5	6	7	8	9	A	B
Adjusted Value (Pixel)	-32	-24	-16	-8	0	+8	+16	+24	+32	+40	+48	+56	+64	+72	+80	+88

Horizontal Sync Delay

Adjustment of the starting position of horizontal sync signal

HSDL [7:0]

Unit: [pixel]

Register Setting Value (0x)	MSB[7 : 4]																
	8	9	A	B	C	D	E	F	0*	1	2	3	4	5	6	7	
LSB [3 : 0]	0*	-128	-112	-96	-80	-64	-48	-32	-16	0	+16	+32	+48	+64	+80	+96	+112
	1	-127	-111	-95	-79	-63	-47	-31	-15	+1	+17	+33	+49	+65	+81	+97	+113
	2	-126	-110	-94	-78	-62	-46	-30	-14	+2	+18	+34	+50	+66	+82	+98	+114
	3	-125	-109	-93	-77	-61	-45	-29	-13	+3	+19	+35	+51	+67	+83	+99	+115
	4	-124	-108	-92	-76	-60	-44	-28	-12	+4	+20	+36	+52	+68	+84	+100	+116
	5	-123	-107	-91	-75	-59	-43	-27	-11	+5	+21	+37	+53	+69	+85	+101	+117
	6	-122	-106	-90	-74	-58	-42	-26	-10	+6	+22	+38	+54	+70	+86	+102	+118
	7	-121	-105	-89	-73	-57	-41	-25	-9	+7	+23	+39	+55	+71	+87	+103	+119
	8	-120	-104	-88	-72	-56	-40	-24	-8	+8	+24	+40	+56	+72	+88	+104	+120
	9	-119	-103	-87	-71	-55	-39	-23	-7	+9	+25	+41	+57	+73	+89	+105	+121
	A	-118	-102	-86	-70	-54	-38	-22	-6	+10	+26	+42	+58	+74	+90	+106	+122
	B	-117	-101	-85	-69	-53	-37	-21	-5	+11	+27	+43	+59	+75	+91	+107	+123
	C	-116	-100	-84	-68	-52	-36	-20	-4	+12	+28	+44	+60	+76	+92	+108	+124
	D	-115	-99	-83	-67	-51	-35	-19	-3	+13	+29	+45	+61	+77	+93	+109	+125
	E	-114	-98	-82	-66	-50	-34	-18	-2	+14	+30	+46	+62	+78	+94	+110	+126
	F	-113	-97	-81	-65	-49	-33	-17	-1	+15	+31	+47	+63	+79	+95	+111	+127

Horizontal Valid Trimmer

Position adjustment of horizontal valid pixel timing signal

HVALT [7:4] :Adjusting the starting position

Register Setting Value (0x)	8	9	A	B	C	D	E	F	0*	1	2	3	4	5	6	7
Adjusted Value (Pixel)	-16	-14	-12	-10	-8	-6	-4	-2	0	+2	+4	+6	+8	+10	+12	+14

HVALT [3:0] :Adjusting the end position

Register Setting Value (0x)	8	9	A	B	C	D	E	F	0*	1	2	3	4	5	6	7
Adjusted Value (Pixel)	-16	-14	-12	-10	-8	-6	-4	-2	0	+2	+4	+6	+8	+10	+12	+14

Vertical Valid Trimmer

Position adjustment of vertical valid line timing signal

VVALT [7:4] :Adjusting the starting position

Register Setting Value (0x)	8	9	A	B	C	D	E	F	0*	1	2	3	4	5	6	7
Adjusted Value (Line)	-8	-7	-6	-5	-4	-3	-2	-1	0	+1	+2	+3	+4	+5	+6	+7

VVALT [3:0] :Adjusting the end position

Register Setting Value (0x)	8	9	A	B	C	D	E	F	0*	1	2	3	4	5	6	7
Adjusted Value (Line)	-8	-7	-6	-5	-4	-3	-2	-1	0	+1	+2	+3	+4	+5	+6	+7

AGC Loop Filter Control

AGCLF [5:0] :Adjusting AGC sync level

Unit: [IRE], Default: 40IRE

Register Setting Value (0x)	MSB [5 : 4]				
	2	3	0*	1	
LSB [3 : 0]	0*	-32	-16	0	+16
	1	-31	-15	+1	+17
	2	-30	-14	+2	+18
	3	-29	-13	+3	+19
	4	-28	-12	+4	+20
	5	-27	-11	+5	+21
	6	-26	-10	+6	+22
	7	-25	-9	+7	+23
	8	-24	-8	+8	+24
	9	-23	-7	+9	+25
	A	-22	-6	+10	+26
	B	-21	-5	+11	+27
	C	-20	-4	+12	+28
	D	-19	-3	+13	+29
	E	-18	-2	+14	+30
	F	-17	-1	+15	+31

Sync Separation Level

SSEPL [6:0] :Adjusting the blanking level

Unit: [IRE], Default: 40IRE

Register Setting Value (0x)	MSB [6 : 4]								
	4	5	6	7	0*	1	2	3	
LSB [3 : 0]	0*	-64	-48	-32	-16	0	+16	+32	+48
	1	-63	-47	-31	-15	+1	+17	+33	+49
	2	-62	-46	-30	-14	+2	+18	+34	+50
	3	-61	-45	-29	-13	+3	+19	+35	+51
	4	-60	-44	-28	-12	+4	+20	+36	+52
	5	-59	-43	-27	-11	+5	+21	+37	+53
	6	-58	-42	-26	-10	+6	+22	+38	+54
	7	-57	-41	-25	-9	+7	+23	+39	+55
	8	-56	-40	-24	-8	+8	+24	+40	+56
	9	-55	-39	-23	-7	+9	+25	+41	+57
	A	-54	-38	-22	-6	+10	+26	+42	+58
	B	-53	-37	-21	-5	+11	+27	+43	+59
	C	-52	-36	-20	-4	+12	+28	+44	+60
	D	-51	-35	-19	-3	+13	+29	+45	+61
	E	-50	-34	-18	-2	+14	+30	+46	+62
	F	-49	-33	-17	-1	+15	+31	+47	+63

ACC Loop Filter Control

ACCLF [4:0] :Adjusting the color burst level

Unit: [IRE], Default: 40IRE

Register Setting Value (0x)	MSB [4]	
	1	0*
0*	-16	0
1	-15	+1
2	-14	+2
3	-13	+3
4	-12	+4
5	-11	+5
6	-10	+6
7	-9	+7
8	-8	+8
9	-7	+9
A	-6	+10
B	-5	+11
C	-4	+12
D	-3	+13
E	-2	+14
F	-1	+15

Hue Control

Adjustment of color subcarrier phase

HUE [7:0]

Unit: [degree]

Register Setting Value (0x)	MSB [7 : 4]															
	8	9	A	B	C	D	E	F	0*	1	2	3	4	5	6	7
0*	-180.0	-157.5	-135.0	-112.5	-90.0	-67.5	-45.0	-22.5	+0.0	+22.5	+45.0	+67.5	+90.0	+112.5	+135.0	+157.5
1	-178.6	-156.1	-133.6	-111.1	-88.6	-66.1	-43.6	-21.1	+1.4	+23.9	+46.4	+68.9	+91.4	+113.9	+136.4	+158.9
2	-177.2	-154.7	-132.2	-109.7	-87.2	-64.7	-42.2	-19.7	+2.8	+25.3	+47.8	+70.3	+92.8	+115.3	+137.8	+160.3
3	-175.8	-153.3	-130.8	-108.3	-85.8	-63.3	-40.8	-18.3	+4.2	+26.7	+49.2	+71.7	+94.2	+116.7	+139.2	+161.7
4	-174.4	-151.9	-129.4	-106.9	-84.4	-61.9	-39.4	-16.9	+5.6	+28.1	+50.6	+73.1	+95.6	+118.1	+140.6	+163.1
5	-173.0	-150.5	-128.0	-105.5	-83.0	-60.5	-38.0	-15.5	+7.0	+29.5	+52.0	+74.5	+97.0	+119.5	+142.0	+164.5
6	-171.6	-149.1	-126.6	-104.1	-81.6	-59.1	-36.6	-14.1	+8.4	+30.9	+53.4	+75.9	+98.4	+120.9	+143.4	+165.9
7	-170.2	-147.7	-125.2	-102.7	-80.2	-57.7	-35.2	-12.7	+9.8	+32.3	+54.8	+77.3	+99.8	+122.3	+144.8	+167.3
8	-168.8	-146.3	-123.8	-101.3	-78.8	-56.3	-33.8	-11.3	+11.3	+33.8	+56.3	+78.8	+101.3	+123.8	+146.3	+168.8
9	-167.3	-144.8	-122.3	-99.8	-77.3	-54.8	-32.3	-9.8	+12.7	+35.2	+57.7	+80.2	+102.7	+125.2	+147.7	+170.2
A	-165.9	-143.4	-120.9	-98.4	-75.9	-53.4	-30.9	-8.4	+14.1	+36.6	+59.1	+81.6	+104.1	+126.6	+149.1	+171.6
B	-164.5	-142.0	-119.5	-97.0	-74.5	-52.0	-29.5	-7.0	+15.5	+38.0	+60.5	+83.0	+105.5	+128.0	+150.5	+173.0
C	-163.1	-140.6	-118.1	-95.6	-73.1	-50.6	-28.1	-5.6	+16.9	+39.4	+61.9	+84.4	+106.9	+129.4	+151.9	+174.4
D	-161.7	-139.2	-116.7	-94.2	-71.7	-49.2	-26.7	-4.2	+18.3	+40.8	+63.3	+85.8	+108.3	+130.8	+153.3	+175.8
E	-160.3	-137.8	-115.3	-92.8	-70.3	-47.8	-25.3	-2.8	+19.7	+42.2	+64.7	+87.2	+109.7	+132.2	+154.7	+177.2
F	-158.9	-136.4	-113.9	-91.4	-68.9	-46.4	-23.9	-1.4	+21.1	+43.6	+66.1	+88.6	+111.1	+133.6	+156.1	+178.6

Sync. Threshold Level Adjust

Adjustment of the detection threshold of horizontal sync signal

SHTR [7:0]

Unit: [IRE]/2

Register Setting Value (0x)	MSB [7 : 4]																
	0	1*	2	3	4	5	6	7	8	9	A	B	C	D	E	F	
LSB [3 : 0]	0	0	16	32	48	64	80	96	112	128	144	160	176	192	208	224	240
	1	1	17	33	49	65	81	97	113	129	145	161	177	193	209	225	241
	2	2	18	34	50	66	82	98	114	130	146	162	178	194	210	226	242
	3	3	19	35	51	67	83	99	115	131	147	163	179	195	211	227	243
	4	4	20	36	52	68	84	100	116	132	148	164	180	196	212	228	244
	5	5	21	37	53	69	85	101	117	133	149	165	181	197	213	229	245
	6	6	22	38	54	70	86	102	118	134	150	166	182	198	214	230	246
	7	7	23	39	55	71	87	103	119	135	151	167	183	199	215	231	247
	8	8	24	40	56	72	88	104	120	136	152	168	184	200	216	232	248
	9	9	25	41	57	73	89	105	121	137	153	169	185	201	217	233	249
	A	10	26	42	58	74	90	106	122	138	154	170	186	202	218	234	250
	B	11	27	43	59	75	91	107	123	139	155	171	187	203	219	235	251
	C	12	28	44	60	76	92	108	124	140	156	172	188	204	220	236	252
	D	13	29	45	61	77	93	109	125	141	157	173	189	205	221	237	253
	E*	14	30	46	62	78	94	110	126	142	158	174	190	206	222	238	254
	F	15	31	47	63	79	95	111	127	143	159	175	191	207	223	239	255

Filter Characteristics

Band Pass Filter (NTSC ITU-RBT.601)

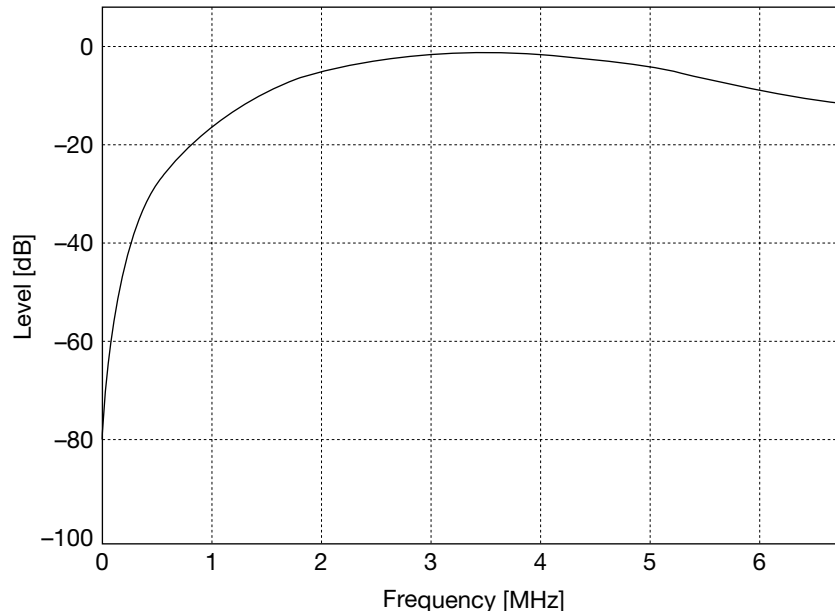

Band Pass Filter (PAL ITU-RBT.601)

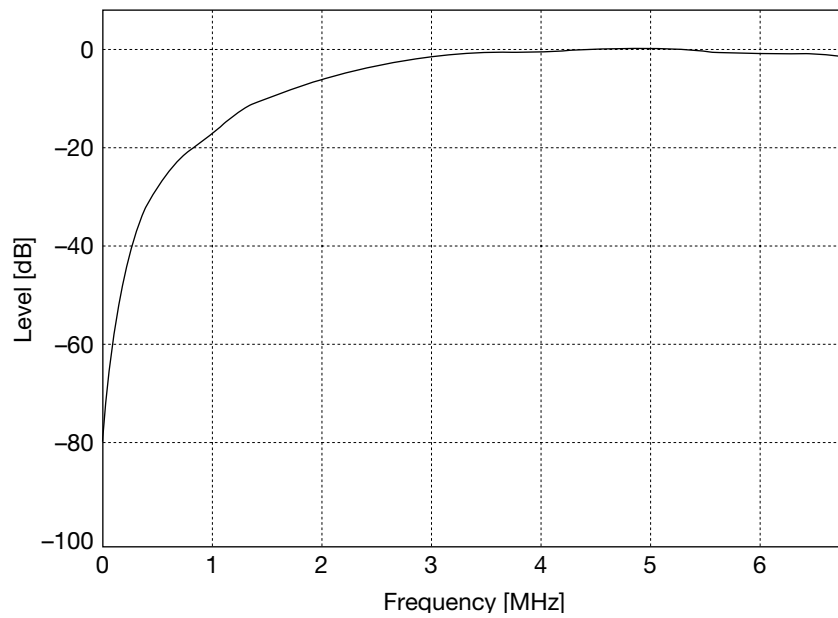

Trap Filter (NTSC ITU-RBT.601)

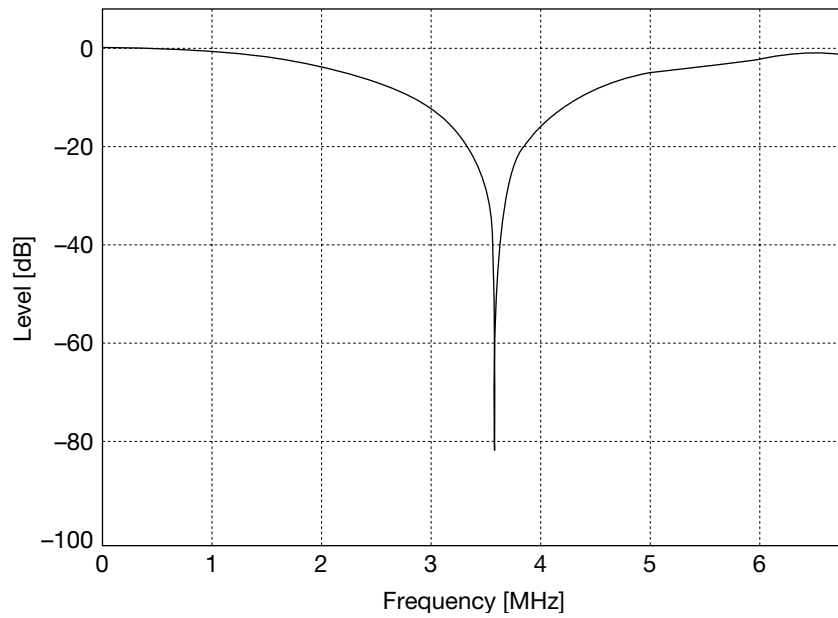

Trap Filter (PAL ITU-RBT.601)

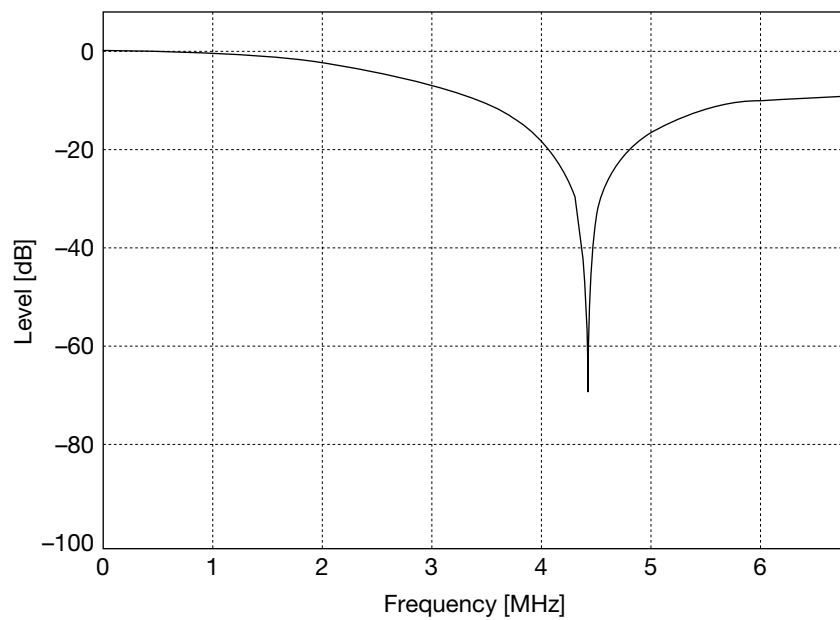

Prefilter

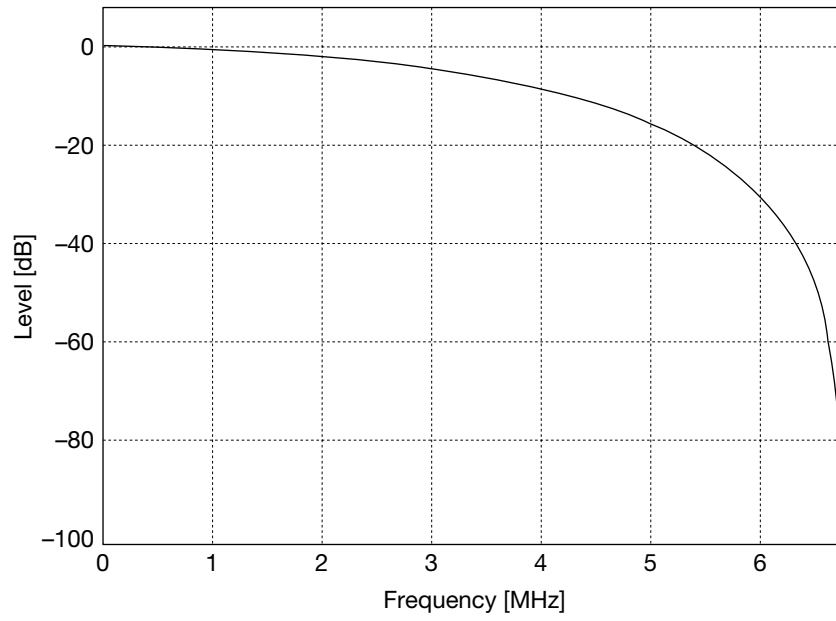

Sharp Filter

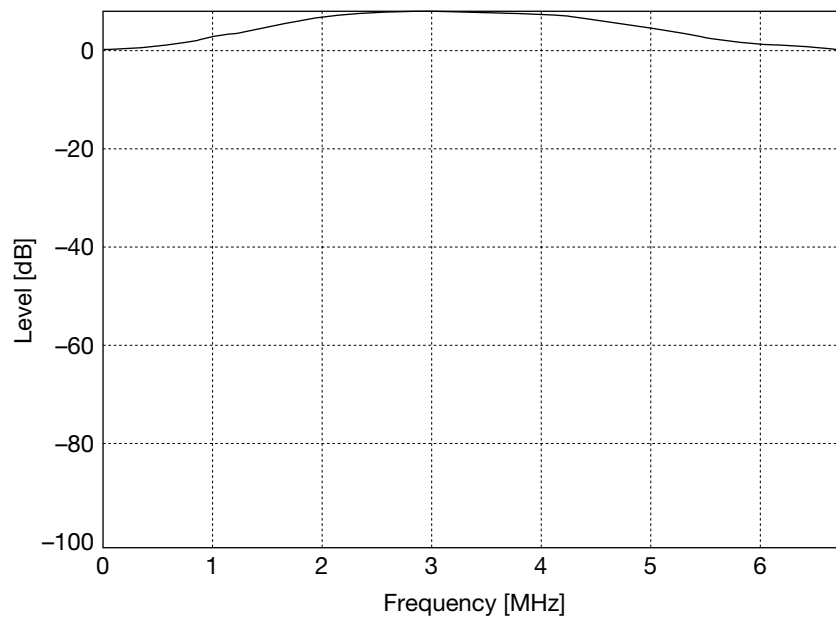

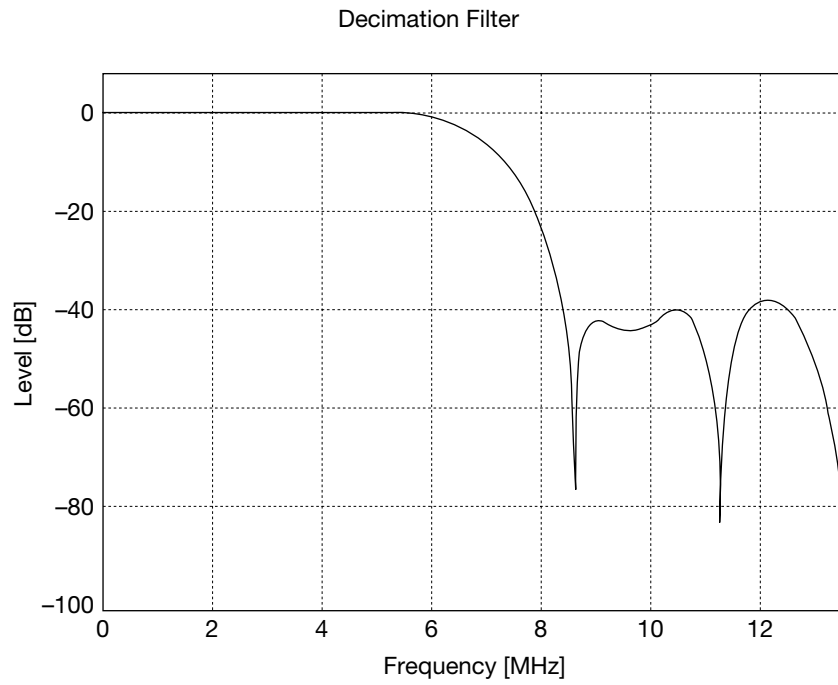

BASIC APPLICATION CIRCUIT EXAMPLES

1) Application Circuit for FIFO-1 and FIFO-2 Modes

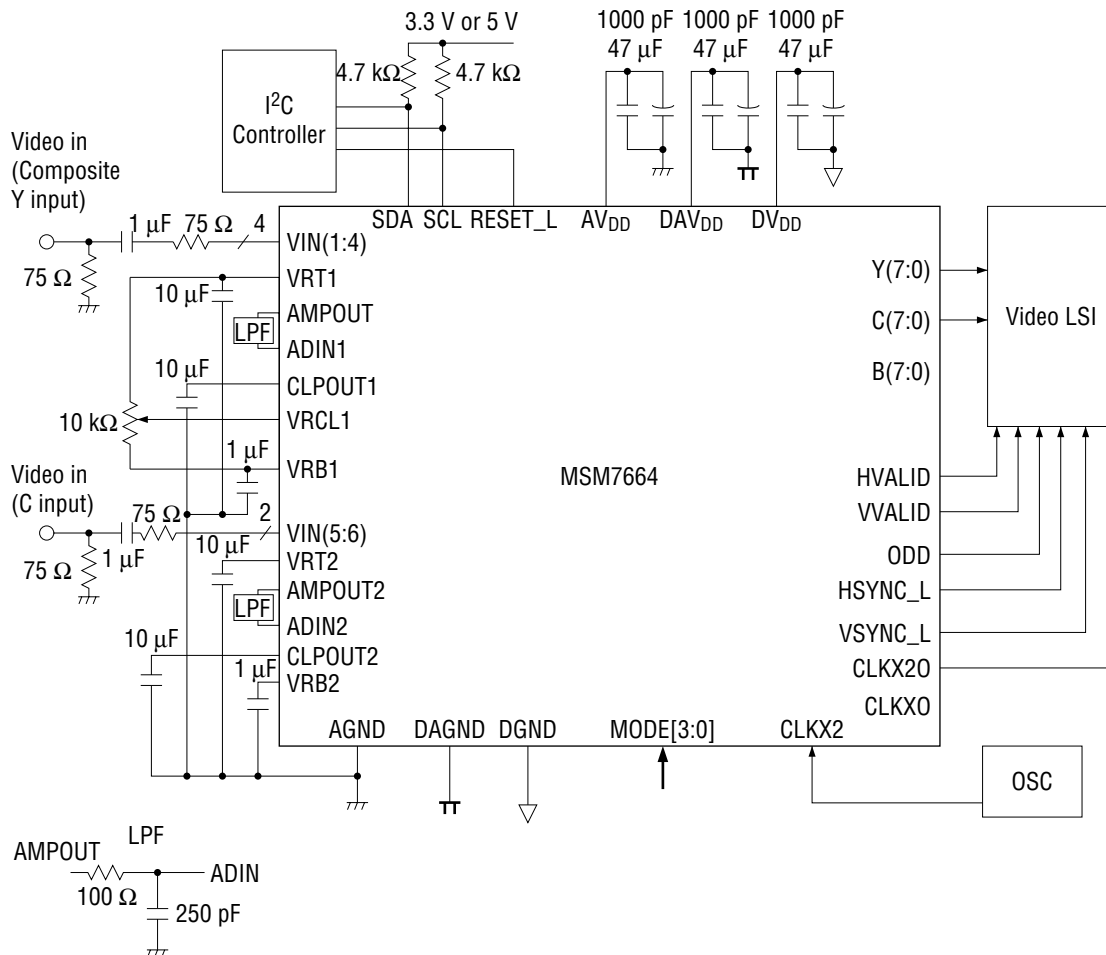

- Connect the M7664 decoder and a video LSI device according to the output interface (ITU-RBT.656, 8-bit [YCbCr], 16-bit [YCbCr], RGB).
- Video input can be four composite inputs or two S-Video inputs.
- Connect unused video input pins to AGND. If a composite signal is input, the C input side (video amp, A/D converter, etc.) will be in the OFF operation state.
- If the input is limited to the composite signal, connect VIN (5:6), VRT2, VRB2, AMPOUT2, ADIN2, and CLPOUT2 pins to AGND. Externally attached components such as capacitors may be removed.
- Set the MODE[3:0] pins to the prescribed setting.
- Supply power and GND for analog, A/D, and digital circuits on the circuit board should be separated at the power source wherever possible. Power and GND lines for analog and A/D circuits must be wide and low impedance.

2) Application Circuit for FM-1 and FM-2 Modes

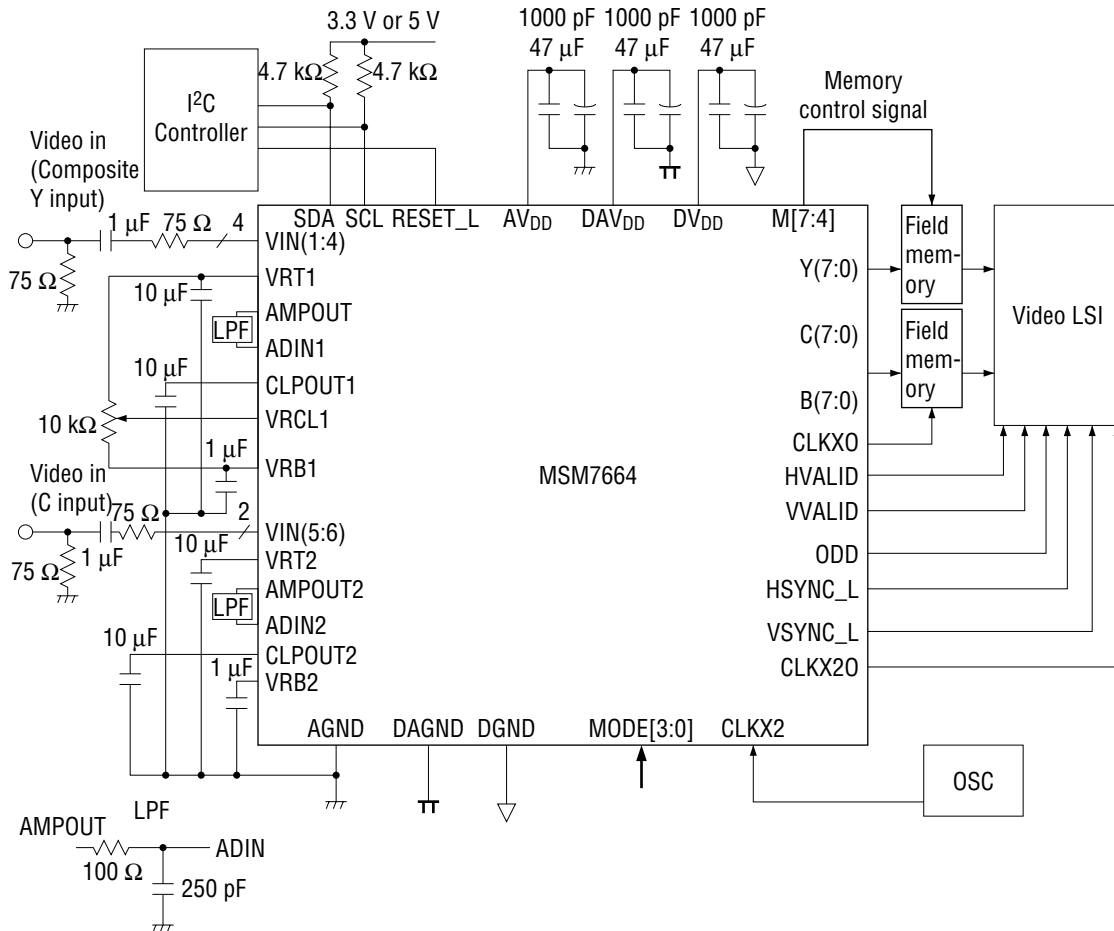

- Select either 16-bit [YCbCr] or RGB output as the output interface.
- Number of field memories utilized
 - 16-bit [YCbCr]: Use 2 field memories.
 - RGB: Use 3 field memories.
- Video input can be four composite inputs or two S-Video inputs.
- Connect unused video input pins to AGND. If a composite signal is input, the C input side (video amp, A/D converter, etc.) will be in the OFF operation state.
- If the input is limited to the composite signal, connect VIN (5:6), VRT2, VRB2, AMPOUT2, ADIN2, and CLPOUT2 pins to AGND. Externally attached components such as capacitors may be removed.
- Set the MODE[3:0] pins to the prescribed setting.
- For the FM-1 mode setting, externally generate and supply control signals for the field memory.
- For the FM-2 mode setting, memory control signals from M[7:4] can be supplied to the field memory.
- For the FM-2 mode setting, the output timing for HSYNC_L, VSYNC_L, ODD, VVALID, and HVALID becomes the memory read timing. Data output from memory is aligned with the various sync signal timings. (See page 31 and page 32)
- Supply power and GND for analog, A/D, and digital circuits on the circuit board should be separated at the power source wherever possible. Power and GND lines for analog and A/D circuits must be wide and low impedance.

NOTES ON USE

- The decoder and encoder ICs have multiple registers for improving and stabilizing their characteristics, and these registers have a function to set the default values for standard signals. Video signals different from standard signals can be input depending on user applications. In this case, it is recommended to set each register to different values from the default values to stabilize the decode operations under the user's requirements. Please contact us for these register settings.
- Stable decode operations cannot always be guaranteed depending on input video signals. Each register can vary its setting values over a wide range but stable operations cannot be guaranteed for all setting values.

PACKAGE DIMENSIONS

(Unit : mm)

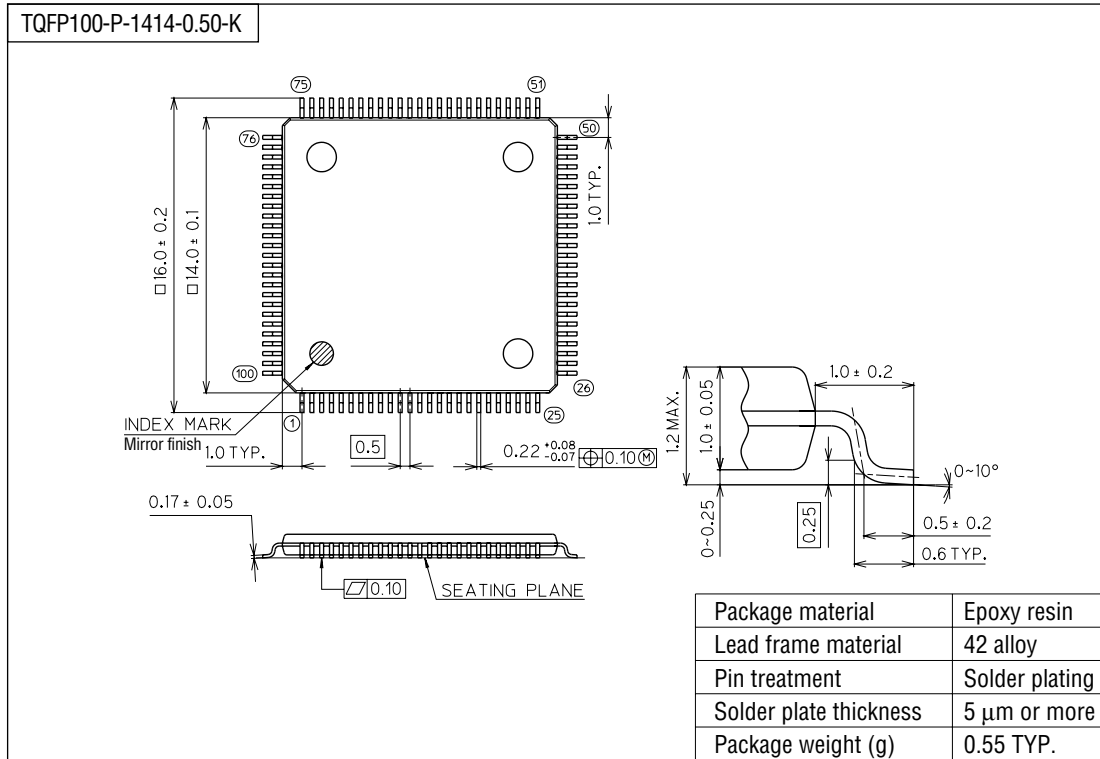

Notes for Mounting the Surface Mount Type Package

The SOP, QFP, TSOP, TQFP, LQFP, SOJ, QFJ (PLCC), SHP, and BGA are surface mount type packages, which are very susceptible to heat in reflow mounting and humidity absorbed in storage. Therefore, before you perform reflow mounting, contact Oki's responsible sales person on the product name, package name, pin number, package code and desired mounting conditions (reflow method, temperature and times).

NOTICE

1. The information contained herein can change without notice owing to product and/or technical improvements. Before using the product, please make sure that the information being referred to is up-to-date.
2. The outline of action and examples for application circuits described herein have been chosen as an explanation for the standard action and performance of the product. When planning to use the product, please ensure that the external conditions are reflected in the actual circuit, assembly, and program designs.
3. When designing your product, please use our product below the specified maximum ratings and within the specified operating ranges including, but not limited to, operating voltage, power dissipation, and operating temperature.
4. Oki assumes no responsibility or liability whatsoever for any failure or unusual or unexpected operation resulting from misuse, neglect, improper installation, repair, alteration or accident, improper handling, or unusual physical or electrical stress including, but not limited to, exposure to parameters beyond the specified maximum ratings or operation outside the specified operating range.
5. Neither indemnity against nor license of a third party's industrial and intellectual property right, etc. is granted by us in connection with the use of the product and/or the information and drawings contained herein. No responsibility is assumed by us for any infringement of a third party's right which may result from the use thereof.
6. The products listed in this document are intended for use in general electronics equipment for commercial applications (e.g., office automation, communication equipment, measurement equipment, consumer electronics, etc.). These products are not authorized for use in any system or application that requires special or enhanced quality and reliability characteristics nor in any system or application where the failure of such system or application may result in the loss or damage of property, or death or injury to humans. Such applications include, but are not limited to, traffic and automotive equipment, safety devices, aerospace equipment, nuclear power control, medical equipment, and life-support systems.
7. Certain products in this document may need government approval before they can be exported to particular countries. The purchaser assumes the responsibility of determining the legality of export of these products and will take appropriate and necessary steps at their own expense for these.
8. No part of the contents contained herein may be reprinted or reproduced without our prior permission.

Copyright 1999 Oki Electric Industry Co., Ltd.

Printed in Japan