

General Description

The MSu001 is a monolithic talking microcomputer that can memorize voice up to 22 seconds using MOSEL qualified coding method(MPCM). It's an integration of traditional 4-bit microcomputer and voice chip with minimal external components. LCD driver and miscellaneous interface are provided for versatile applications. With more than 10K ROM/RAM inside, this chip meets every intelligent novelty. Customer requested function and voice data will be built in by changing masks during fabrication.

Block Diagram

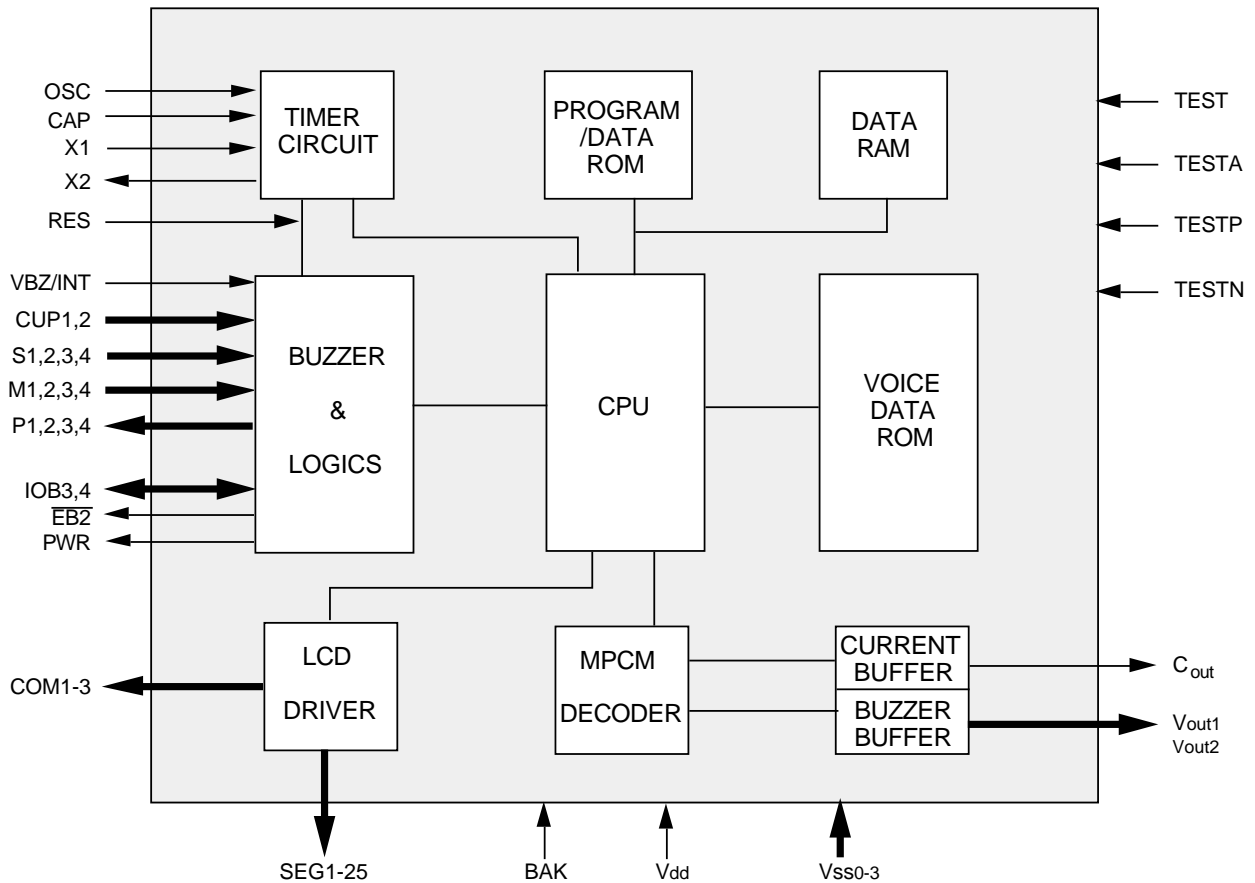

Hardware Features

- Low current consumption
- Maximal function with minimal cost
- Current output could drive 8 ohm speaker with a transistor, Vout could drive buzzer directly.
- The voice content is stored up to 20 seconds at 6 KHz S.R. and can be separated up to 64 sections. 22 seconds at 5.51 KHz sample rate (1DA00h)
- LCD driver provided, can drive up to 75 segments
- Built-In clock generator
- Built-In doubler, halver, tripler
- Internal program ROM : 1024 x 15 bits; Internal program RAM : 64 x 4 bits
- Two 4-bit input ports
- Two 4-bit input/output ports
- One 4-bit output port

Software Features

- 78 instructions, in 48 categories
- 4-level subroutine nesting (also used for interrupt)
- Two external factors (INT, S&M) for interrupt
- Two internal factors (timer, divider) for interrupt

Sample Applications

- handy game with LCD
- versatile timepiece with LCD
- talking timer with LCD
- intelligent calculator with LCD
- smart stationery with LCD
- talking home electronics with LCD
- talking education kit with LCD

Development Supports

- Development tools are provided
- Software / Hardware programming guide is provided
- Engineering sample could be provided

- MSM9058 Developing Card
- MSM9012 LCD display emulation board
- MSM9011 Program code emulation board
- MSM9009 20" (30") Sound emulation board

Mask Options

- mask option for either open or hold transistor on S port & M port
- mask option for either pull down or put up on Interrupt switch
- mask option for either leading edge or trailing edge on Interrupt edge
- mask option for either power back-up activated or not when power on
- mask option for either with reset or not when power on
- mask option for either 8 ms or 2 ms chattering removal time on S port & M port
- mask option for either slow (by 15.625 ms) or fast (by 224.14 us) set time timer
- mask option for either fast system clock (Fosc) or slow system clock (Fosc / 2)
- LCD display frequency : (1) 128 Hz /170.7 Hz (2) 64Hz /85.3 Hz (3) 32Hz /42.7Hz
- LCD driver : (1) static (2) 1/2 bias 1/2 duty (3) 1/2 bias 1/3 duty

AC Characteristics at 4.5 V & 6 KHz S.R.

Timing		Min.	Max.	Remarks
T _W	Write Enable pulse width	300ns	—	SRD
T _H	Trigger address hold time	80ns	—	SRD
T _S	Trigger address setup time	220ns	—	SRD
T _{WB}	Write Enable to BUSY delay time	—	1 us	SRD
T _{WA}	Write Enable to Audio delay time	—	500us	SRD

SRD := Sample Rate Dependent

Pad Descriptions

Pad No.	Signal		I/O	F u n c t i o n s
1	Vdd1	1	Power	Positive power supply for CPU function block
2	Vreg	1	O	Voltage regulator
3,4	CUP1,2	2	I	Voltage doubler capacitor
5	X1	1	I	Crystal Oscillator input, 32768 Hz
6	X2	1	O	Crystal Oscillator Output, 32768 Hz
7	CAP	1	O	Phase compensating capacitor
8,35,34	Com1,2,3	3	O	Common plate for LCD panel
9-33	SEG1-25	25	O	25 segment outputs for LCD panel
38,39,36	Vss1,2,3	3	Power	Negative power supply
37	BAK	1	Power	BackUp negative power supply
40,41	S4,S3	2	I	One-way input port; note 1
42	PWR(alm)	1	I/O	Pop noise eliminating signal; internally connected to CPU output port
43	#EB2	1	I/O	Enable signal to latch section address; internally connected to CPU output port
44-47	TG0,1,2,3	4	I/O	Trigger address inputs to voice function block; note 2
48	RESET	1	I	System reset
49	Vdd2	1	Power	Positive supply for voice function block, internally connected to pad 1
50	Rosc	1	I	Oscillator Resistor for voice function block
51	Vss0	1	Power	Negative power supply for voice signal
52	Cout	1	O	Audio signal current output
53,54	Vout1,2	2	O	Audio signal voltage output
55,56	TG4,5	2	I/O	Trigger address inputs to voice function block; note 3
57,58	IOB3,4	2	I/O	Bidirectional input/output port, 2 bits
59	VBZ/INT	1	I/O	Busy status output; internally connected to INT (interrupt request) pin of CPU
60-63	P1,2,3,4	4	O	One-way output port, 4 bits
64-67	M1,2,3,4	4	I	One-way input port; note 1
68,69	NC	1	NC	No connection
70,71	S2,S1	2	I	One-way input port, note 1

Note 1. with chatter removal time for either 8 ms (ph8) or 2 ms (ph6)

Note 2. internally connected to CPU I/O port, IOA1=TG0, IOA2=TG1, IOA3=TG2, IOA4=TG3

Note 3. internally connected to CPU I/O port, IOB1=TG4, IOB2=TG5

Absolute Maximum Rating (Vdd=3.0V, Vss=Vss2=0.0V, Vss3=0.0V/-1.5V)

Symbol	Rating	Unit
Vss1	1.2-1.8	V
BAK	0.0-0.6	V
Vreg	0.0-0.6	V
CAP	Vreg-Vd	V
X1	Vreg-Vdd	V
S1,2,3,4	Vss-Vdd	V
M1,2,3,4	Vss-Vdd	V
(IOA1,2,3,4)TG0,1,2,3	Vss-Vdd	V
IOB1,2,3,4	Vss-Vdd	V
VBZ/INT	Vss-Vdd	V
RESET	Vss-Vdd	V

Symbol	Rating	Unit
Rosc	Vss-Vdd	V
X2	Vreg-Vdd	V
PWR(ALM)	Vss-Vdd	V
#EB2	Vss-Vdd	V
P1,2,3,4	Vss3-Vdd	V
SEG1-25	Vss3-Vdd	V
COM1,2,3	Vss3-Vdd	V
CUP1,2	Vss3-Vdd	V
Vout1,2	Vss-Vdd	V
T(operating)	-60+60	Degree C
T(storage)	-55+125	Degree C

Common Plate Usage

	Static	1/2 duty	1/3 duty
COM1	V	V	V
COM2	-	V	V
COM2	-	-	V
Alternating Frequency	32 Hz	32 Hz	43 Hz

DC Characteristics at 3.0 Vdd (u001,u001T)

Symbol	Name	Valid	Min.	Typ.	Max.	Unit	Remarks
I sb	stand by I	Vdd	-	1	-	uA	
I op	operation I	Vdd	-	0.2	-	mA	
I ohv	output high I	Vouts	-	5	-	mA	
I oLv	output low I	Vouts	-	5	-	mA	
I co	current output	Cout	-	2.5	-	mA	u001
		Cout	-	1.5	-	mA	u001T
d F/F	frequency stability		-5	-	5	%	[Fosc(3.0V)-Fosc(2.7V)]/Fosc(3.0V)
d F/F	frequency variation		-10	-	10	%	6 KHz S.R., 1.2 Mohm Rosc
R osc	oscillation R	Rosc	-	1.2	-	Mohm	S.R.=6000 Hz, u001
		Rosc	-	880	-	kohm	S.R.=8000 Hz, u001
R osc	oscillation R	Rosc	-	1.1	-	Mohm	S.R.=6000 Hz, u001T
		Rosc	-	830	-	kohm	S.R.=8000 Hz, u001T

DC Characteristics at 4.5 Vdd (u001, u001T)

Symbol	Name	Valid	Min.	Typ.	Max.	Unit	Remarks
I sb	stand by I	Vdd	-	1	-	uA	
I op	operation I	Vdd	-	0.8	-	mA	
I ohv	output high I	Vouts	-	12	-	mA	
I oLv	output low I	Vouts	-	12	-	mA	
I co	current output	Cout	-	4	-	mA	u001
		Cout	-	2.5	-	mA	u001T
V ohp	o/p high V	P port	*-0.4V			V	I oh = -400 uA
V oLp	o/p low V	P port			*+0.4V	V	I oL = 400 uA
V ohw	o/p low V	PWR	*-0.4V			V	I oh = -1 mA
V oLw	o/p high V	PWR			*+0.4V	V	I oL = 1 mA
V ohio	o/p low V	i/o port	*-0.4V			V	I oh = -100 uA
V oLio	o/p high V	i/o port			*+0.4V	V	I oL = 100 uA
V ohc	o/p low V	Com	*-0.4V			V	I oh = -4 uA
V oLc	o/p high V	Com			*+0.4V	V	I oL = 4 uA
V ohg	o/p low V	Seg's	*-0.4V			V	I oh = -0.4 uA
V oLg	o/p high V	Seg's			*+0.4V	V	I oL = 0.4 uA
d F/F	frequency stability		-5	-	5	%	[Fosc(4.5V)-Fosc(4.0V)]/Fosc(4.5V)
d F/F	frequency variation		-10	-	10	%	6 KHz S.R., 1.2 Mohm Rosc
R isn	input R when on	S port	-	330	-	kohm	pulldown X'tor=on & note 1
R isf	input R when off	S port	-	30	-	kohm	pulldown X'tor=off, halt mode & note 1
R imn	input R when on	M port	-	30	-	kohm	pulldown X'tor=on & note 1
R imf	input R when off	M port	-	30	-	kohm	pulldown X'tor=off, halt mode & note 1
R inh	input R	VBZ,INT	-	140	-	kohm	Vss2=0V, Vi=Vdd, VBZ=high
R inL	input R	VBZ,INT	-	3	-	kohm	Vss2=0V, Vi=Vdd, VBZ=low
R ir	input R	RESET	-	18	-	kohm	Vss2=0V, Vi=Vdd
R osc	oscillation R	Rosc	-	1.2	-	Mohm	S.R.=6000 Hz, u001
		Rosc	-	910	-	kohm	S.R.=8000 Hz, u001
R osc	oscillation R	Rosc	-	1.1	-	Mohm	S.R.=6000 Hz, u001T
		Rosc	-	800	-	kohm	S.R.=8000 Hz, u001T

Note 1. Vss2=0V, Vi=Vss2+0.4V

Note 2. *:= Vdd

DC Characteristics at 3.0 Vdd (u7001)

Symbol	Name	Valid	Min.	Typ.	Max.	Unit	Remarks
I _{sb}	stand by I	V _{dd}	-	300	-	uA	
I _{op}	operation I	V _{dd}	-	0.5	-	mA	
I _{ohv}	output high I	V _{outs}	-	7	-	mA	
I _{oLv}	output low I	V _{outs}	-	6	-	mA	
I _{co}	current output	C _{out}	-	2.5	-	mA	
d F/F	frequency stability		-5	-	5	%	[Fosc(3.0V)-Fosc(2.7V)]/Fosc(3.0V)
d F/F	frequency variation		-10	-	10	%	6 KHz SR, 1.2 Mohm Rosc
R _{is}	input R	S port	-	-	-	kohm	
R _{im}	input R	M port	-	-	-	kohm	
R _{osc}	oscillation R	Rosc	-	1.2	-	Mohm	S.R.=6000 Hz
		Rosc	-	850	-	kohm	S.R.=8000 Hz

Please refer next page for DC characteristics at 4.5V





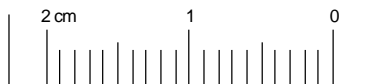

COB Information I

Silk screen & copper print

COB model number : MOSEL 001
 Chip bonded : either u001 or u7001



Legend

-  Copper pad for X'tal
-  Copper pad for LCD
-  Copper pad for LCD
-  Copper pad
-  Through hole
-  Through hole
-  Alignment hole for Jig

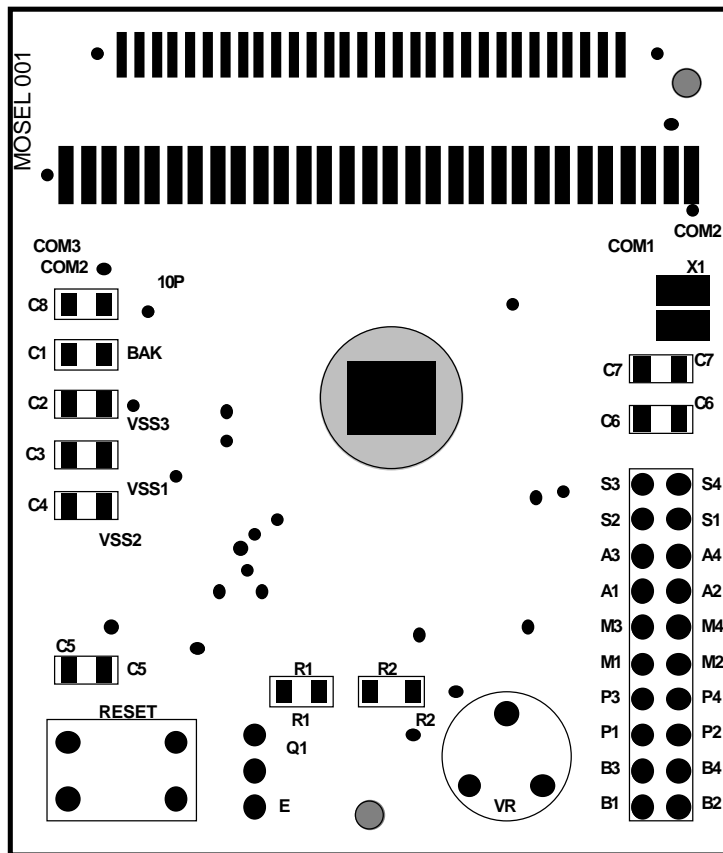

DC Characteristics at 4.5 Vdd (u7001)

Symbol	Name	Valid	Min.	Typ.	Max.	Unit	Remarks
I _{sb}	stand by I	V _{dd}	-	900	-	uA	
I _{op}	operation I	V _{dd}	-	1.0	-	mA	
I _{ohv}	output high I	V _{outs}	-	16	-	mA	
I _{oLv}	output low I	V _{outs}	-	12	-	mA	
I _{co}	current output	Cout	-	4	-	mA	
d F/F	frequency stability		-5	-	5	%	$[F_{osc}(4.5V) - F_{osc}(V-0.5)] / F_{osc}(4.5V)$
d F/F	frequency variation		-10	-	10	%	6 KHz S.R., 1.2 Mohm R _{osc}
R _{is}	input R	S port	-	140	-	kohm	V _{ss2} =0V, V _i =V _{ss2} +0.4, halt mode
R _{im}	input R	M port	-	150	-	kohm	V _{ss2} =0V, V _i =V _{ss2} +0.4, open mode
R _{osc}	oscillation R	Rosc	-	1.2	-	Mohm	S.R.=6000 Hz
		Rosc	-	880	-	kohm	S.R.=8000 Hz

Please refer to previous page for Characteristics at 3.0 V

COB Information II

Signal Name & Location Description

COB model number : MOSEL 001
 Chip bonded : either u001 or u7001
 Please refer previous page for legends

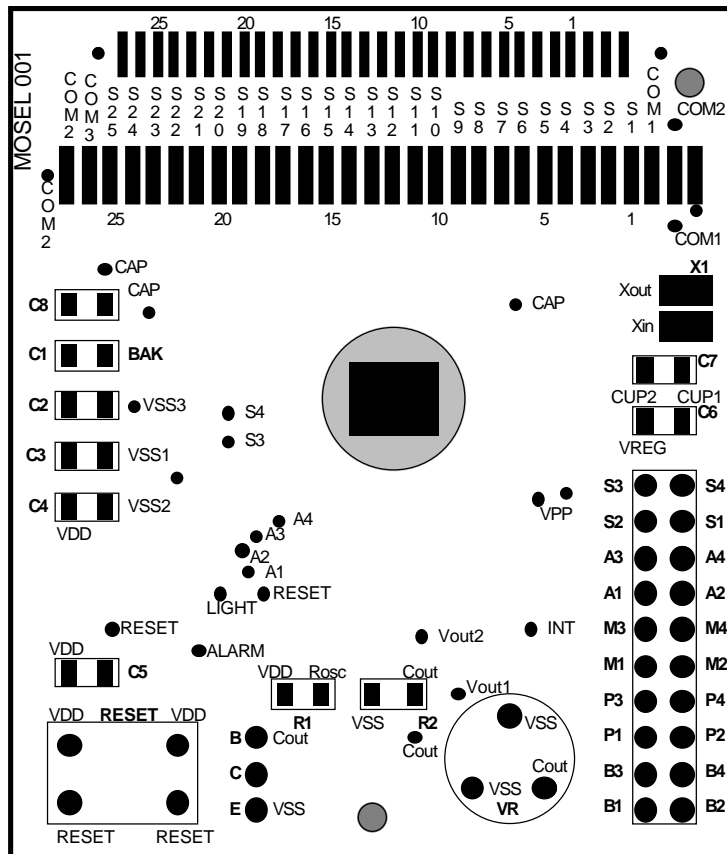
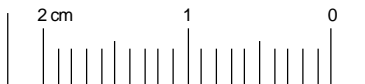

Timing Diagram

I. Addressing 6 - bit

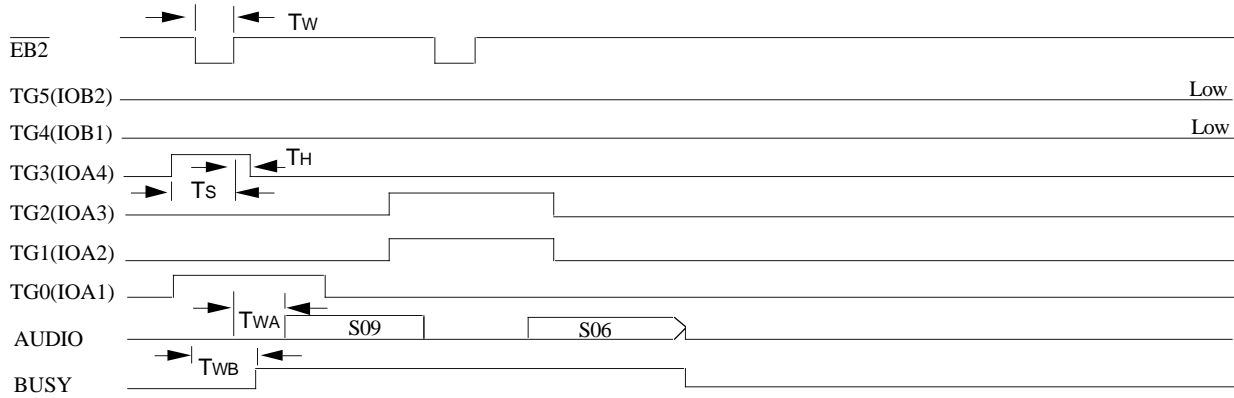

One portion of the program to play a sound

```

CLRM 4h      ; #EB2 Low
OUT  PA , R5 ;
OUT  PB , R6 ;
SETM 4h      ; #EB2 High
    
```

II. PWR Signal

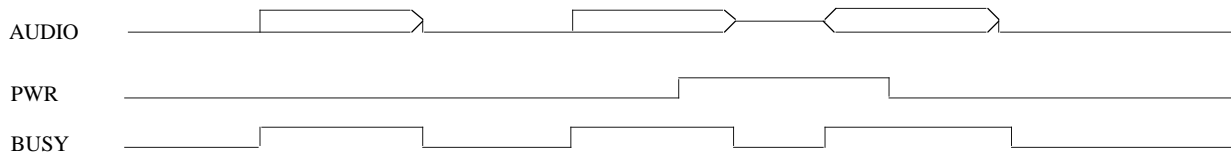

1. When PWR is high, MSu001 audio output signal will stay at approx. 2.4V even there is no audio output.
2. When PWR is low, MSu001 audio output signal will stay at GND level when there is no audio output.
3. For eliminating the "pop" noise purpose, PWR should be at high level when a sound section is played over, and also at high level in between two sound sections.
4. For energy saving purpose, PWR should not always stay at high level, since there will be a hundred-mA current consumption when PWR is high. So it should go to low level when its not needed.

StandardCode LineUp

- MSSu001-066 Mandarin talking watch/clock
- MSSu001-068 English talking watch/clock
- MSSu001-078 Russian talking calculator
- MSSu001-090 Mandarin talking calculator

Bonding Diagram

Pad No.	Designation	X	Y	Pad No.	Designation	X	Y
1	VDD	-1983.1	325.2	13	SEG5	-1443.1	-1639.5
2	VREG	-1983.1	145.2	14	SEG6	-1263.1	-1639.5
3	CUP1	-1983.1	- 34.8	15	SEG7	-1083.1	-1639.5
4	CUP2	-1983.1	- 214.8	16	SEG8	- 903.1	-1639.5
5	X1	-1983.1	- 394.8	17	SEG9	- 723.1	-1639.5
6	X2	-1983.1	- 665.1	18	SEG10	- 543.1	-1639.5
7	CAP	-1983.1	-1033.7	19	SEG11	- 363.1	-1639.5
8	COM1	-1983.1	-1261.4	20	SEG12	- 183.1	-1639.5
9	SEG1	-1983.1	-1459.4	21	SEG13	- 3.1	-1639.5
10	SEG2	-1983.1	-1639.5	22	SEG14	176.9	-1639.5
11	SEG3	-1983.1	-1639.5	23	SEG15	356.9	-1639.5
12	SEG4	-1983.1	-1639.5	24	SEG16	536.9	-1639.5

Pad No.	Designation	X	Y	Pad No.	Designation	X	Y
25	SEG17	716.9	-1639.5	37	BAK	1947.1	- 676.3
26	SEG18	896.9	-1639.5	38	VSS1	1937.1	- 496.3
27	SEG19	1076.9	-1639.5	39	VSS2	-1983.1	- 316.3
28	SEG20	1256.9	-1639.5	40	S4	-1983.1	- 136.3
29	SEG21	1436.9	-1639.5	41	S3	-1983.1	43.7
30	SEG22	1616.9	-1639.5	42	PWR(ALM)	-1983.1	223.7
31	SEG23	1796.9	-1639.5	43	EB2 (LIGHT)	-1983.1	403.7
32	SEG24	1976.9	-1639.5	44	TG0(IOA1)	-1983.1	583.7
33	SEG25	1983.9	-1459.5	45	TG1(IOA2)	-1983.1	763.7
34	COM3	1983.9	-1279.3	46	TG2(IOA3)	-1983.1	943.7
35	COM2	1983.9	-1036.3	47	TG3(IOA4)	-1983.1	1123.7
36	VSS3	1947.1	- 856.3	48	RESET	-1983.1	1303.7

Pad No.	Designation	X	Y	Pad No.	Designation	X	Y
49	VDD	1941.2*	1637.8	61	P2	-1178.2	1642.9
50	OSC	1588.6	1636.1	62	P3	-1358.2	1642.9
51	VSS0	1370	1630.6	63	P4	-1538.2	1642.9
52	COUT	1151.4	1611.4	64	M1	-1718.2	1642.9
53	VOUT1	524.5	1612.3	65	M2	-1898.2	1642.9
54	VOUT2	122.1	1612.3	66	M3	-1983.1	1405.2
55	TG4(IOB1)	- 98.2	1642.9	67	M4	-1983.1	1225.2
56	TG5(IOB2)	- 278.2	1642.9	68	NC	-1983.1	1045.2
57	IOB3	- 458.2	1642.9	69	NC	-1983.1	865.2
58	IOB4	- 638.2	1642.9	70	S2	-1983.1	685.2
59	VBZ/INT	- 818.2	1642.9	71	S1	-1983.1	505.2
60	P1	- 998.2	1642.9				

Application Circuit

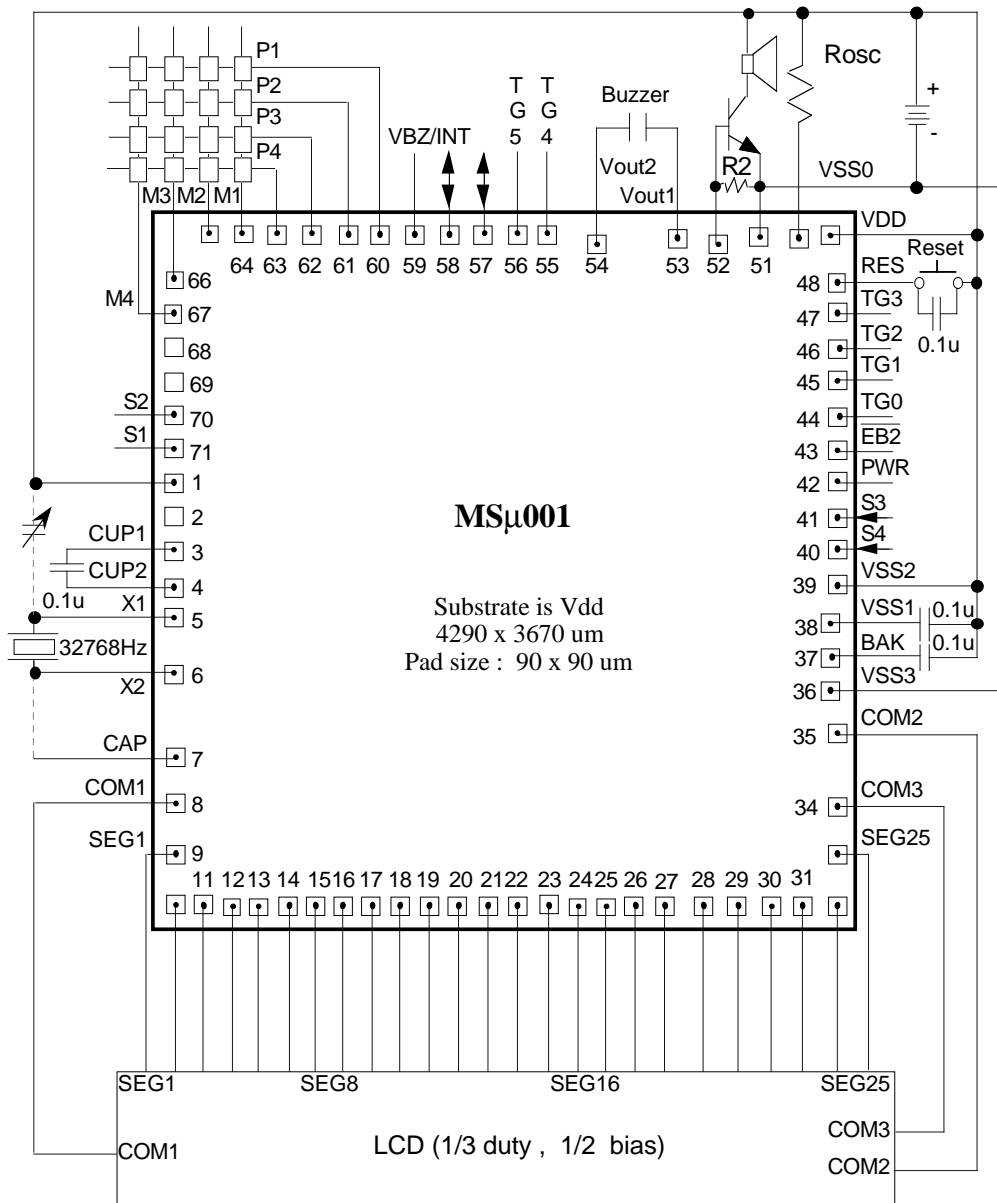

- Note:
1. T(transistor) = $\beta > 150$, $R2=470\Omega$, S(speaker) = 1/4 w, 8 Ω ; all typical.
 2. $R2=470\Omega$ (typical) to bypass extra current into base to get rid of waveform saturation on collector .
 3. Piezo buzzer resonant frequency is around 1K Hz.
 4. All the above components need to adjust possibly case by case to meet required performance.
 5. Vout1,Vout2 are tristate during stand by.

Taiwan
 #1, Creation Road I,
 Science-based Industrial Park,
 Hsinchu 30077
 Taiwan, ROC
 "taylor_hsiao@ccmail.mosel.com.tw"
 TEL: 886-35-770055
 FAX: 886-35-772788
 FAX: 886-35-784732

Taipei
 7F, #102 Section 3,
 Ming Chung East Road,
 Taipei,
 Taiwan, ROC
 TEL: 886-2-5451213
 FAX: 886-2-5451214

Hongkong
 #19 Dai Fu Street,
 Taipo Industrial Estate,
 Taipo, N.T.
 Hongkong
 TEL: 852-2388-8277
 TEL: 852-2665-4883
 FAX: 852-2664-2406
 FAX: 852-2770-8011

U.S.A.
 #3910 North First Street,
 San Jose,
 CA.65134-1501
 U.S.A.
 TEL: 1-408-433-6000
 FAX: 1-408-433-0952

T O : Mosel Vitelic Inc.
 886-35-772788 (fax)
 Attention : Sales & Marketing Department

Product Request Form

We hereby request MVI to start preparing produce MSSu001 which is specified as below descriptions as well as form A and form B.

I already read this data sheet and understand MSu001 completely and know how to specify to fit my requirement.

General Descriptions		Chip Descriptions	
Customer		Title	
Agent		SampleRate	Hz
Sales Represen.	Who is MVI sales you contact ?	Output Device	<input type="checkbox"/> Buzzer (F fr= 1K Hz) <input type="checkbox"/> Speaker (8 ohm, 1" diam) <input type="checkbox"/> Other _____
Sound Providing to MVI	<input type="checkbox"/> 8-bit PCM sound files <input type="checkbox"/> .WAV sound files <input type="checkbox"/> DAT or equivalent <input type="checkbox"/> Something special in written memo <input type="checkbox"/> Others _____	Working Voltage	<input type="checkbox"/> 2.5 V <input type="checkbox"/> 3.0 V <input type="checkbox"/> 3.5 V <input type="checkbox"/> 4.0 V <input type="checkbox"/> 4.5 V <input type="checkbox"/> 5.0 V <input type="checkbox"/> 5.5 V <input type="checkbox"/> 6.0 V
Code Providing to MVI	<input type="checkbox"/> .TRA program file, name = _____ <input type="checkbox"/> .EVA LCD file, name = _____ <input type="checkbox"/> .HEX program file, name = _____ <input type="checkbox"/> .HEX LCD file, name = _____		
Serviced Required from MVI	<input type="checkbox"/> EPROMs with data inside <input type="checkbox"/> files to pro'med into EPROM <input type="checkbox"/> 9011 & 9012 emulation boards <input type="checkbox"/> u7001 chip on board <input type="checkbox"/> Confirm table <input type="checkbox"/> Others _____	Power Source	<input type="checkbox"/> Battery size "D" <input type="checkbox"/> Battery size "AA" <input type="checkbox"/> Battery size "AAA" <input type="checkbox"/> Battery button cell <input type="checkbox"/> Mains <input type="checkbox"/> Other _____

Company Name : _____
 Signature : _____
 Position Title : _____
 Department, Section : _____
 Signature Date : _____

TITLE _____

Product Request Form A : Voice Word Definitions : There are **words defined.**

Address	Voice Description	VoiceLength	MuteLength	WordTotal ≤ 80000h									
00	00h	S	00h	S	00h	00h	33	21h	S	00h	S	00h	00h
01	01h	S	00h	S	00h	00h	34	22h	S	00h	S	00h	00h
02	02h	S	00h	S	00h	00h	35	23h	S	00h	S	00h	00h
03	03h	S	00h	S	00h	00h	36	24h	S	00h	S	00h	00h
04	04h	S	00h	S	00h	00h	37	25h	S	00h	S	00h	00h
05	05h	S	00h	S	00h	00h	38	26h	S	00h	S	00h	00h
06	06h	S	00h	S	00h	00h	39	27h	S	00h	S	00h	00h
07	07h	S	00h	S	00h	00h	40	28h	S	00h	S	00h	00h
08	08h	S	00h	S	00h	00h	41	29h	S	00h	S	00h	00h
09	09h	S	00h	S	00h	00h	42	2Ah	S	00h	S	00h	00h
10	0Ah	S	00h	S	00h	00h	43	2Bh	S	00h	S	00h	00h
11	0Bh	S	00h	S	00h	00h	44	2Ch	S	00h	S	00h	00h
12	0Ch	S	00h	S	00h	00h	45	2Dh	S	00h	S	00h	00h
13	0Dh	S	00h	S	00h	00h	46	2Eh	S	00h	S	00h	00h
14	0Eh	S	00h	S	00h	00h	47	2Fh	S	00h	S	00h	00h
15	0Fh	S	00h	S	00h	00h	48	30h	S	00h	S	00h	00h
16	10h	S	00h	S	00h	00h	49	31h	S	00h	S	00h	00h
17	11h	S	00h	S	00h	00h	50	32h	S	00h	S	00h	00h
18	12h	S	00h	S	00h	00h	51	33h	S	00h	S	00h	00h
19	13h	S	00h	S	00h	00h	52	34h	S	00h	S	00h	00h
20	14h	S	00h	S	00h	00h	53	35h	S	00h	S	00h	00h
21	15h	S	00h	S	00h	00h	54	36h	S	00h	S	00h	00h
22	16h	S	00h	S	00h	00h	55	37h	S	00h	S	00h	00h
23	17h	S	00h	S	00h	00h	56	38h	S	00h	S	00h	00h
24	18h	S	00h	S	00h	00h	57	39h	S	00h	S	00h	00h
25	19h	S	00h	S	00h	00h	58	3Ah	S	00h	S	00h	00h
26	1Ah	S	00h	S	00h	00h	59	3Bh	S	00h	S	00h	00h
27	1Bh	S	00h	S	00h	00h	60	3Ch	S	00h	S	00h	00h
28	1Ch	S	00h	S	00h	00h	61	3Dh	S	00h	S	00h	00h
29	1Dh	S	00h	S	00h	00h	62	3Eh	S	00h	S	00h	00h
30	1Eh	S	00h	S	00h	00h	63	3Fh	S	00h	S	00h	00h
31	1Fh	S	00h	S	00h	00h	Length summ. of above 64 words <input type="text" value="00h"/> must be ≤ 1DA00h						
32	20h	S	00h	S	00h	00h	Signature & date _____						
							MVI Sales & date _____						

TITLE	
--------------	--

Product Request Form B : Mask Definitions

Mask options		S e l e c t i o n s		
1	Power bias	<input checked="" type="checkbox"/> Li - 1/2 Bias		
2	LCD driver & display frequency	<input type="checkbox"/> 1/2 duty 128 Hz	<input type="checkbox"/> 1/2 duty 64 Hz	<input type="checkbox"/> 1/2 duty 32 Hz
		<input type="checkbox"/> 1/3 duty 170.7 Hz	<input type="checkbox"/> 1/3 duty 85.3 Hz	<input type="checkbox"/> 1/3 duty 42.7 Hz
		<input type="checkbox"/> Static 128 Hz	<input type="checkbox"/> Static 64 Hz	<input type="checkbox"/> Static 32 Hz
3	S-port defined	<input type="checkbox"/> Open	<input type="checkbox"/> Hold transistor	
4	M-port defined	<input type="checkbox"/> Open	<input type="checkbox"/> Hold transistor	
5	Interrupt switch	<input type="checkbox"/> Pull down	<input type="checkbox"/> Pull up	
6	Interrupt edge	<input type="checkbox"/> Rising	<input type="checkbox"/> Falling	
7	Power-on mode	<input type="checkbox"/> BackUp	<input type="checkbox"/> Non-BackUp	
8	External Reset	<input type="checkbox"/> and PowerOn reset	<input type="checkbox"/> Only	
9	^{note} Chatter Removal time	<input type="checkbox"/> 8 mS time	<input type="checkbox"/> 2 mS time	
10	^{note} Set time	<input type="checkbox"/> Slower (Tk=512 mS)	<input type="checkbox"/> Faster (Tk=8000uS)	
11	Oscillator	<input checked="" type="checkbox"/> Crystal		
12	System Clock	<input type="checkbox"/> Fast (Fosc)	<input type="checkbox"/> Slow (Fosc/2)	
13	Alarm frequency	<input checked="" type="checkbox"/> Level shift		
14	P-port	<input checked="" type="checkbox"/> Level shift		
15	^{note} Input port signal	<input checked="" type="checkbox"/> Level shift		
16	Light mode	<input checked="" type="checkbox"/> Always		
17	Reset level	<input checked="" type="checkbox"/> High		
18	I/O port	<input checked="" type="checkbox"/> Level shift		
19	Light	<input checked="" type="checkbox"/> Level shift		

Note 9 : For S port and M port

Note 10 : Set time = (set value + 1) * Tk / Fosc ; Fosc is in KHz

Note 15 : Input port control signal level shift, J48, J49

Signature & date	
MVI sales & date	