
Features

- 2.4-GHz Radio Transceiver
- Operates in the Unlicensed Industrial, Scientific, and Medical (ISM) Band (2.4 GHz to 2.483 GHz)
- -95 dBm Reception Sensitivity
- Up to 0 dBm Output Power
- Range of up to 50 Meters or More
- Data Throughput of up to 62.5 kbits/s
- Highly Integrated, Low Cost, Minimal Number of External Components Required
- Dual DSSS Reconfigurable Baseband Correlators
- SPI Microcontroller Interface (up to 2-MHz Data Rate)
- 13-MHz Input Clock Operation
- Low Standby Current < 1 μ A
- Integrated 32-bit Manufacturing ID
- Operating Voltage from 2.7 V to 3.6 V
- Operating Temperature from -40°C to +85°C
- Offered in a Small Footprint QFN48 Package

Applications

- PC Human Interface Devices
 - Mice
 - Keyboards
 - Joysticks
- Peripheral Gaming Devices
 - Game Controllers
 - Console Keyboards
- General
 - Presenter Tools
 - Remote Controls
 - Consumer Electronics
 - Barcode Scanners
 - POS Peripherals
 - Toys

Functional Description

The ATR2434 transceiver is a single-chip 2.4-GHz Direct Sequence Spread Spectrum (DSSS) Gaussian Frequency Shift Keying (GFSK) baseband modem radio that connects directly to a microcontroller.



WirelessUSB™
2.4-GHz DSSS
Radio SoC

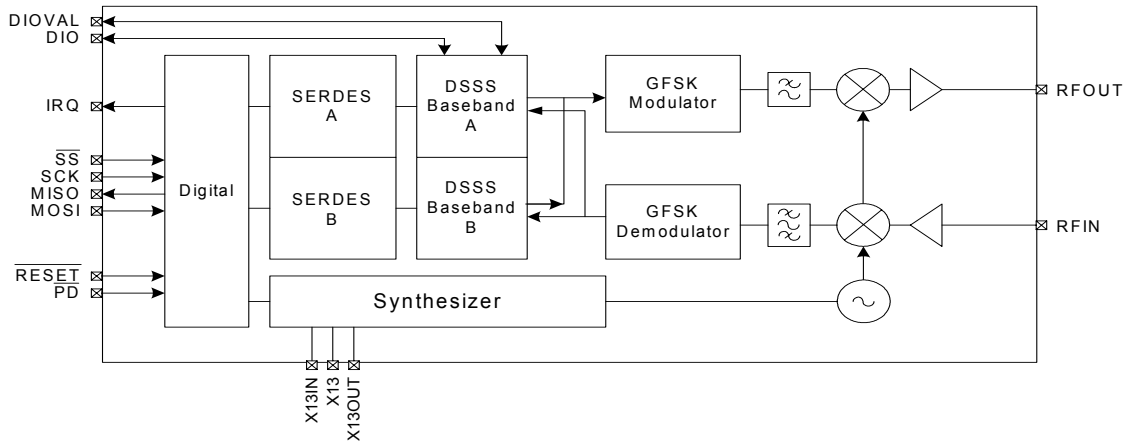
ATR2434

Preliminary

Rev. 4822C-ISM-09/04

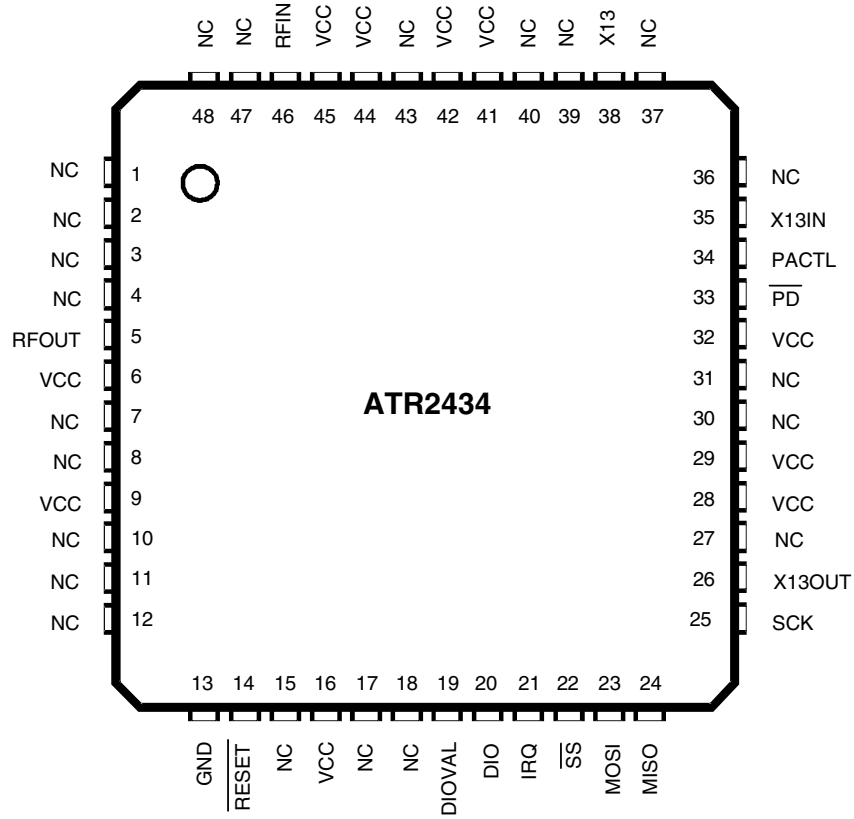


Figure 1. Simplified Block Diagram



Pin Configuration

Figure 2. Pinning QFN48



Pin Description

Pin No.	Symbol	Type	Default	Function
Analog RF				
46	RFIN	Input	Input	RF input. Modulated RF signal received.
5	RFOUT	Output	N/A	RF output. Modulated RF signal to be transmitted.
Crystal/Power Control				
38	X13	Input	N/A	Crystal input (see section "Clocking and Power Management" on page 5).
35	X13IN	Input	N/A	Crystal input (see section "Clocking and Power Management" on page 5).
26	X13OUT	Output/Hi-Z	Output	System clock. Buffered 13-MHz system clock.
33	PD	Input	N/A	Power down. Asserting this input (low), will put the IC in the suspend mode (X13OUT is 0 when PD is low).
14	RESET	Input	N/A	Active LOW reset. Device reset.
34	PACTL	I/O	Input	PACTL. External power amplifier control. Pull-down or make output.
SERDES Bypass Mode Communications/Interrupt				
20	DIO	I/O	Input	Data input/output. SERDES bypass mode data transmit/receive.
19	DIOVAL	I/O	Input	Data I/O valid. SERDES bypass mode data transmit/receive valid.
21	IRQ	Output/Hi-Z	Output	IRQ. Interrupt and SERDES bypass mode DIOCLK.
SPI Communications				
23	MOSI	Input	N/A	Master-output-slave-input data. SPI data input pin.
24	MISO	Output/Hi-Z	Hi-Z	Master-input-slave-output data. SPI data output pin.
25	SCK	Input	N/A	SPI input clock. SPI clock.
22	SS	Input	N/A	Slave select enable. SPI enable.
Power and Ground				
6, 9, 16, 28, 29, 32, 41, 42, 44, 45	VCC	VCC	H	VCC = 2.7 V to 3.6 V.
13	GND	GND	L	Ground = 0 V.
1, 2, 3, 4, 7, 8, 10, 11, 12, 15, 17, 18, 27, 30, 31, 36, 37, 39, 40, 43, 47, 48	NC	N/A	N/A	Tie to ground.
Exposed paddle	GND	GND	L	Must be tied to ground.



Applications Support

The ATR2434 is supported by both the WirelessUSB Development Kit and the WirelessUSB N:1 Development Kit. The development kit provides all of the materials and documents needed to cut the cord on multipoint to point and point to point low bandwidth high node density applications including four small form-factor sensor boards and a hub board that connect to WirelessUSB RF module boards, comprehensive WirelessUSB protocol code examples and all of the associated schematics, gerber files and bill of materials. The WirelessUSB N:1 Development Kit is also supported by the WirelessUSB Listener Tool.

Functional Overview

The ATR2434 provides a complete WirelessUSB SPI to antenna radio modem. The ATR2434 is designed to implement wireless devices operating in the worldwide 2.4-GHz Industrial, Scientific, and Medical (ISM) frequency band (2.400 GHz to 2.4835 GHz). It is intended for systems compliant with world-wide regulations covered by ETSI EN 301 489-1 V1.4.1, ETSI EN 300 328-1 V1.3.1 (European Countries); FCC CFR 47 Part 15 (USA and Industry Canada) and ARIB STD-T66 (Japan).

The ATR2434 contains a 2.4-GHz radio transceiver, a GFSK modem and a dual DSSS reconfigurable baseband. The radio and baseband are both code- and frequency-agile. Forty-nine spreading codes selected for optimal performance (Gold codes) are supported across 78 1-MHz channels yielding a theoretical spectral capacity of 3822 channels. The ATR2434 supports a range of up to 50 meters or more.

2.4-GHz Radio

The receiver and transmitter are a single-conversion low-Intermediate Frequency (low-IF) architecture with fully integrated IF channel matched filters to achieve high performance in the presence of interference. An integrated Power Amplifier (PA) provides an output power control range of 30 dB in seven steps.

Both the receiver and transmitter integrated Voltage Controlled Oscillator (VCO) and synthesizer have the agility to cover the complete 2.4-GHz GFSK radio transmitter ISM band. The VCO loop filter is also integrated on-chip.

GFSK Modem

The transmitter uses a DSP-based vector modulator to convert the 1-MHz chips to an accurate GFSK carrier.

The receiver uses a fully integrated Frequency Modulator (FM) detector with automatic data slicer to demodulate the GFSK signal.

Dual DSSS Baseband

Data is converted to DSSS chips by a digital spreader. De-spreading is performed by an oversampled correlator. The DSSS baseband cancels spurious noise and assembles properly correlated data bytes.

The DSSS baseband has four operating modes: 64 chips/bit single channel, 32 chips/bit dual channel, 32 chips/bit single channel $2 \times$ oversampled, and 32 chips/bit single channel Dual Data Rate (DDR).

64 Chips/Bit Single Channel

The baseband supports a single data stream operating at 15.625 kbits/s. The advantage of selecting this mode is its ability to tolerate a noisy environment. This is because the 15.625 kbits/s data stream utilizes the longest PN code resulting in the highest probability for recovering packets over the air. This mode can also be selected for systems requiring data transmissions over longer ranges.

32 Chips/Bit Dual Channel	The baseband supports two non-simultaneous data streams each operating at 31.25 kbits/s.
32 Chips/Bit Single Channel 2 × Oversampled	The baseband supports a single data stream operating at 31.25 kbits/s that is sampled twice as much as the other modes. The advantage of selecting this mode is its ability to tolerate a noisy environment.
32 Chips/Bit Single Channel Dual Data Rate (DDR)	The baseband spreads bits in pairs and supports a single data stream operating at 62.5 kbits/s.

Serializer/Deserializer (SERDES)

The ATR2434 provides a data Serializer/Deserializer (SERDES), which provides byte-level framing of transmit and receive data. Bytes for transmission are loaded into the SERDES and receive bytes are read from the SERDES via the SPI interface. The SERDES provides double buffering of transmit and receive data. While one byte is being transmitted by the radio the next byte can be written to the SERDES data register insuring there are no breaks in transmitted data.

After a receive byte has been received it is loaded into the SERDES data register and can be read at any time until the next byte is received, at which time the old contents of the SERDES data register will be overwritten.

Application Interfaces

The ATR2434 has a fully synchronous SPI slave interface for connectivity to the application MCU. Configuration and byte-oriented data transfer can be performed over this interface. An interrupt is provided to trigger real time events.

An optional SERDES Bypass mode (DIO) is provided for applications that require a synchronous serial bit-oriented data path. This interface is for data only.

Clocking and Power Management

A 13-MHz crystal is directly connected to X13IN and X13 without the need for external capacitors. The ATR2434 has a programmable trim capability for adjusting the on-chip load capacitance supplied to the crystal. The Radio Frequency (RF) circuitry has on-chip decoupling capacitors. The ATR2434 is powered from a 2.7 V to 3.6 V DC supply. The ATR2434 can be shutdown to a fully static state using the \overline{PD} pin.

Below are the requirements for the crystal to be directly connected to X13IN and X13:

- Nominal frequency: 13 MHz
- Operating mode: fundamental mode
- Resonance mode: parallel resonant
- Frequency stability: ± 30 ppm
- Series resistance: $\leq 100 \Omega$
- Load capacitance: 10 pF
- Drive level: 10 μ W to 100 μ W

Receive Signal Strength Indicator (RSSI)

The RSSI register (Reg 0x22) returns the relative signal strength of the ON-channel signal power and can be used to:

1. determine the connection quality,
2. determine the value of the noise floor, and
3. check for a quiet channel before transmitting.

The internal RSSI voltage is sampled through a 5-bit Analog-to-Digital Converter (ADC). A state machine controls the conversion process. Under normal conditions, the RSSI state machine initiates a conversion when an ON-channel carrier is detected and remains above the noise floor for over 50 μ s. The conversion produces a 5-bit value in the RSSI register (Reg 0x22, bits 4:0) along with a valid bit, RSSI register (Reg 0x22, bit 5). The state machine then remains in HALT mode and does not reset for a new conversion until the receive mode is toggled off and on. Once a connection has been established, the RSSI register can be read to determine the relative connection quality of the channel. A RSSI register value lower than 10 indicates that the received signal strength is low, a value greater than 28 indicates a strong signal level.

To check for a quiet channel before transmitting, first set up the receive mode properly and read the RSSI register (Reg 0x22). If the valid bit is zero, then force the Carrier Detect register (Reg 0x2F, bit 7 = 1) to initiate an ADC conversion. Then, wait a minimum of 50 μ s and read the RSSI register again. Next, clear the Carrier Detect register (Reg 0x2F, bit 7 = 0) and turn the receiver OFF. Measuring the noise floor of a quiet channel is inherently a noisy process so, for best results, this procedure should be repeated several times (~20) to compute an average noise floor level. A RSSI register value of 0-10 indicates a channel that is relatively quiet. A RSSI register value greater than 10 indicates the channel is probably being used. A RSSI register value greater than 28 indicates the presence of a strong signal.

Application Interfaces

SPI Interface

The ATR2434 has a four-wire SPI communication interface between an application MCU and one or more slave devices. The SPI interface supports single-byte and multi-byte serial transfers. The four-wire SPI communications interface consists of Master Out-Slave In (MOSI), Master In-Slave Out (MISO), Serial Clock (SCK), and Slave Select (\overline{SS}).

The SPI receives SCK from an application MCU on the SCK pin. Data from the application MCU is shifted in on the MOSI pin. Data to the application MCU is shifted out on the MISO pin. The active-low Slave Select (\overline{SS}) pin must be asserted to initiate an SPI transfer.

The application MCU can initiate an SPI data transfer via a multi-byte transaction. The first byte is the Command/Address byte, and the following bytes are the data bytes as shown in Table 1 on page 7 and Figure 3 through Figure 5 on page 7. The \overline{SS} signal should not be deasserted between bytes. The SPI communications is as follows:

- Command direction (bit 7) = 0 enables SPI read transaction. A 1 enables SPI write transactions.
- Command increment (bit 6) = 1 enables SPI auto address increment. When set, the address field automatically increments at the end of each data byte in a burst access, otherwise the same address is accessed.
- Six bits of address.
- Eight bits of data.

The SPI communications interface has a burst mechanism, where the command byte can be followed by as many data bytes as desired. A burst transaction is terminated by deasserting the slave select ($\overline{SS} = 1$).

The SPI communications interface single read and burst read sequences are shown in Figure 3 and Figure 4, respectively.

The SPI communications interface single write and burst write sequences are shown in Figure 5 and Figure 6 on page 8, respectively.

Table 1. SPI Transaction Format

	Byte 1		Byte 1 + N	
Bit #	7	6	[5:0]	[7:0]
Bit Name	DIR	INC	Address	Data

Figure 3. SPI Single Read Sequence

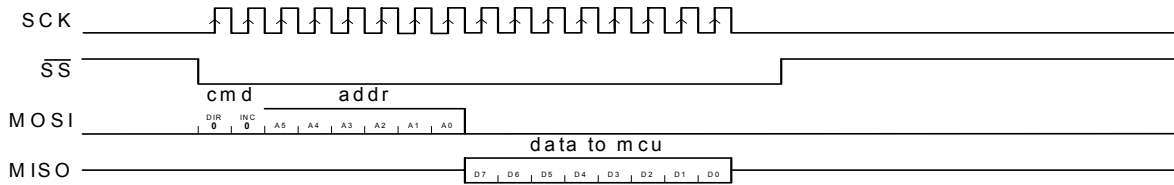


Figure 4. SPI Burst Read Sequence

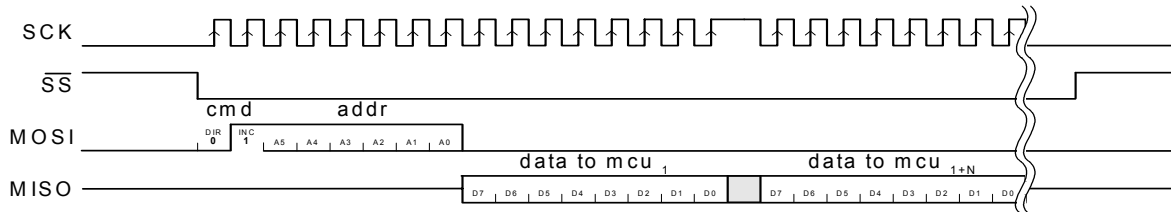


Figure 5. SPI Single Write Sequence

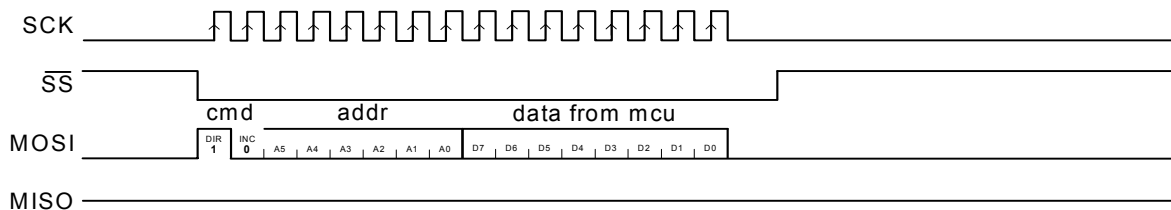
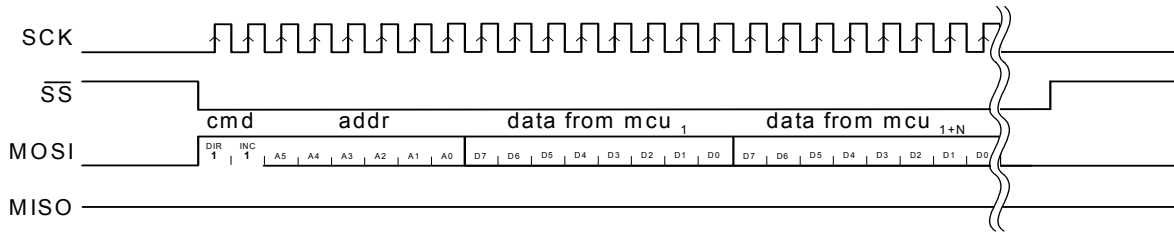


Figure 6. SPI Burst Write Sequence



DIO Interface

The DIO communications interface is an optional SERDES bypass data-only transfer interface. In receive mode, DIO and DIOVAL are valid after the falling edge of IRQ, which clocks the data as shown in Figure 7. In transmit mode, DIO and DIOVAL are sampled on the falling edge of the IRQ, which clocks the data as shown in Figure 8. The application MCU samples the DIO and DIOVAL on the rising edge of IRQ.

Figure 7. DIO Receive Sequence

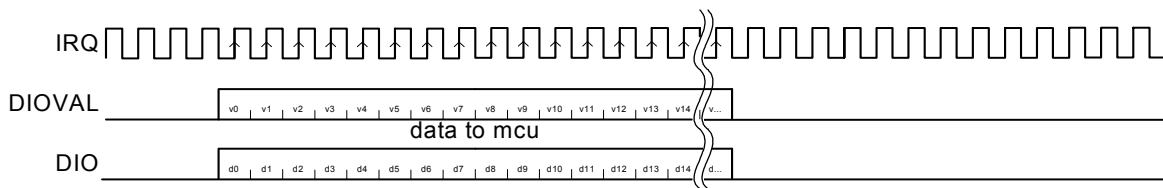
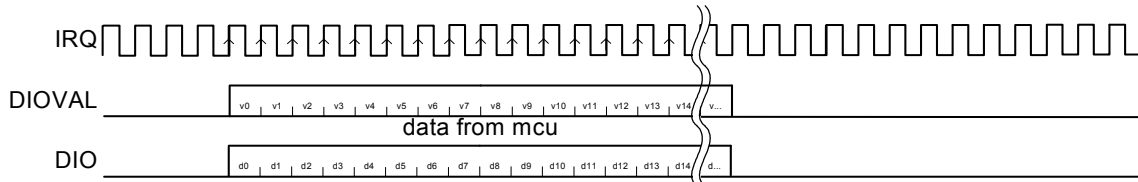


Figure 8. DIO Transmit Sequence



Interrupts

The ATR2434 features three sets of interrupts: transmit, receive, and a wake interrupt. These interrupts all share a single pin (IRQ), but can be independently enabled/disabled. In transmit mode, all receive interrupts are automatically disabled, and in transmit mode all receive interrupts are automatically disabled. However, the contents of the enable registers are preserved when switching between transmit and receive modes.

Interrupts are enabled and the status reads through 6 registers: Receive Interrupt Enable (Reg 0x07), Receive Interrupt Status (Reg 0x08), Transmit Interrupt Enable (Reg 0x0D), Transmit Interrupt Status (Reg 0x0E), Wake Enable (Reg 0x1C), Wake Status (Reg 0x1D).

If more than 1 interrupt is enabled at any time, it is necessary to read the relevant interrupt status register to determine which event caused the IRQ pin to assert. Even when a given interrupt source is disabled, the status of the condition that would otherwise cause an interrupt can be determined by reading the appropriate interrupt status register. It is therefore possible to use the devices without making use of the IRQ pin at all. Firmware can poll the interrupt status register(s) to wait for an event, rather than using the IRQ pin.

The polarity of all interrupts can be set by writing to the Configuration register (Reg 0x05), and it is possible to configure the IRQ pin to be open drain (if active low) or open source (if active high).

Wake Interrupt

When the PD pin is low, the oscillator is stopped. After PD is deasserted, the oscillator takes time to start, and until it has done so, it is not safe to use the SPI interface. The wake interrupt indicates that the oscillator has started, and that the device is ready to receive SPI transfers.

The wake interrupt is enabled by setting bit 0 of the Wake Enable register (Reg 0x1C, bit 0 = 1). Whether or not a wake interrupt is pending is indicated by the state of bit 0 of the Wake Status register (Reg 0x1D, bit 0). Reading the Wake Status register (Reg 0x1D) clears the interrupt.

Transmit Interrupts

Four interrupts are provided to flag the occurrence of transmit events. The interrupts are enabled by writing to the Transmit Interrupt Enable register (Reg 0x0D), and their status may be determined by reading the Transmit Interrupt Status register (Reg 0x0E). If more than 1 interrupt is enabled, it is necessary to read the Transmit Interrupt Status register (Reg 0x0E) to determine which event caused the IRQ pin to assert.

The function and operation of these interrupts are described in detail in the section "Register Descriptions" on page 10.

Receive Interrupts

Eight interrupts are provided to flag the occurrence of receive events, four each for SERDES A and B. In 64 chips/bit and 32 chips/bit DDR modes, only the SERDES A interrupts are available, and the SERDES B interrupts will never trigger, even if enabled. The interrupts are enabled by writing to the Receive Interrupt Enable register (Reg 0x07), and their status may be determined by reading the Receive Interrupt Status register (Reg 0x08). If more than one interrupt is enabled, it is necessary to read the Receive Interrupt Status register (Reg 0x08) to determine which event caused the IRQ pin to assert.

The function and operation of these interrupts are described in detail in the section "Register Descriptions" on page 10.



Register Descriptions

Table 2 displays the list of registers inside the ATR2434 that are addressable through the SPI interface. All registers are read and writable, except where noted.

Table 2. Register Map⁽¹⁾

Register Name	Mnemonic	Address	Default	Access
Revision ID	REG_ID	0x00	0x07	RO
Synthesizer A Counter	REG_SYN_A_CNT	0x01	0x00	RW
Synthesizer N Counter	REG_SYN_N_CNT	0x02	0x00	RW
Control	REG_CONTROL	0x03	0x00	RW
Data Rate	REG_DATA_RATE	0x04	0x00	RW
Configuration	REG_CONFIG	0x05	0x01	RW
SERDES Control	REG_SERDES_CTL	0x06	0x03	RW
Receive Interrupt Enable	REG_RX_INT_EN	0x07	0x00	RW
Receive Interrupt Status	REG_RX_INT_STAT	0x08	0x00	RO
Receive Data A	REG_RX_DATA_A	0x09	0x00	RO
Receive Valid A	REG_RX_VALID_A	0x0A	0x00	RO
Receive Data B	REG_RX_DATA_B	0x0B	0x00	RO
Receive Valid B	REG_RX_VALID_B	0x0C	0x00	RO
Transmit Interrupt Enable	REG_TX_INT_EN	0x0D	0x00	RW
Transmit Interrupt Status	REG_TX_INT_STAT	0x0E	0x00	RO
Transmit Data	REG_TX_DATA	0x0F	0x00	RW
Transmit Valid	REG_TX_VALID	0x10	0x00	RW
PN Code	REG_PN_CODE	0x11-0x18	0x1E8B6A3DE0E9B222	RW
Threshold Low	REG_THRESHOLD_L	0x19	0x08	RW
Threshold High	REG_THRESHOLD_H	0x1A	0x38	RW
Wake Enable	REG_WAKE_EN	0x1C	0x00	RW
Wake Status	REG_WAKE_STAT	0x1D	0x01	RO
Analog Control	REG_ANALOG_CTL	0x20	0x04	RW
Channel	REG_CHANNEL	0x21	0x00	RW
Receive Signal Strength Indicator	REG_RSSI	0x22	0x00	RO
Power Control	REG_PA	0x23	0x00	RW
Crystal Adjust	REG_CRYSTAL_ADJ	0x24	0x00	RW
VCO Calibration	REG_VCO_CAL	0x26	0x00	RW
AGC Control	REG_AGC_CTL	0x2E	0x00	RW
Carrier Detect	REG_CARRIER_DETECT	0x2F	0x00	RW
Clock Manual	REG_CLOCK_MANUAL	0x32	0x00	RW
Clock Enable	REG_CLOCK_ENABLE	0x33	0x00	RW
Synthesizer Lock Count	REG_SYN_LOCK_CNT	0x38	0x64	RW
Manufacturing ID	REG_MID	0x3C-0x3F	-	RO

Note: 1. All registers are accessed Little Endian.

Table 3. Revision ID Register

Addr: 0x00		REG_ID				Default: 0x07	
7	6	5	4	3	2	1	0
Silicon ID				Product ID			

Bit	Name	Description
7:4	Silicon ID	These are the Silicon ID revision bits. 0000 = Rev A, 0001 = Rev B, etc. These bits are read-only.
3:0	Product ID	These are the Product ID revision bits. Fixed at value 0111. These bits are read-only.

Table 4. Synthesizer A Counter

Addr: 0x01		REG_SYN_A_CNT				Default: 0x00	
7	6	5	4	3	2	1	0
Reserved				Count			

Bit	Name	Description
7:5	Reserved	These bits are reserved and should be written with zeros.
4:0	Count	The Synthesizer A Counter register is used for diagnostic purposes and is not recommended for normal operation. The Channel register is the recommended method of setting the Synthesizer frequency. The Synthesizer A Count along with the Synthesizer N Count can be used to generate the Synthesizer frequency. The range of valid values of the Synthesizer A Count is 0 through 31. Using the Synthesizer A and N Count register is an alternative to using the Channel register. Selection between the use of the Channel register or the A and N registers is done through the Channel register (Reg 0x21, bit 7). When in Channel mode the A and N Count bits can be used to read the A and N values derived directly from the Channel.

Table 5. Synthesizer N Counter

Addr: 0x02		REG_SYN_N_CNT				Default: 0x00	
7	6	5	4	3	2	1	0
Reserved		Count					

Bit	Name	Description
7	Reserved	This bit is reserved and should be written with zero.
6:0	Count	The Synthesizer N Counter register is used for diagnostic purposes and therefore is not recommended for normal operation. The Channel register is the recommended method of setting the Synthesizer frequency. The Synthesizer N Count along with the Synthesizer A Count can be used to generate the Synthesizer frequency. The range of valid values of the Synthesizer N Count is 74 through 76. Using the Synthesizer A and N Count register is an alternative to using the Channel register. Selection between the use of the Channel register or the A and N registers is done through the Channel register (Reg 0x21, bit 7). When in Channel mode the A and N Count bits can be used to read the A and N values derived directly from the Channel.

Table 6. Control

Addr: 0x03		REG_CONTROL				Default: 0x00	
7	6	5	4	3	2	1	0
RX Enable	TX Enable	PN Code Select	Auto Syn Count Select	Auto PA Disable	PA Enable	Auto Syn Disable	Syn Enable

Bit	Name	Description
7	RX Enable	The Receive Enable bit is used to place the IC in receive mode. 1 = Receive Enabled 0 = Receive Disabled
6	TX Enable	The Transmit Enable bit is used to place the IC in transmit mode. 1 = Transmit Enabled 0 = Transmit Disabled
5	PN Code Select	The Pseudo-noise Code Select bit selects between the upper or lower half of the 64 chips/bit PN code. 1 = 32 Most Significant Bits of PN code are used 0 = 32 Least Significant Bits of PN code are used This bit applies only when the Code Width bit is set to 32 chips/bit PN codes (Reg 0x04, bit 2 = 1).
4	Auto Syn Count Select	The Auto Synthesizer Count Select bit is used to select the method of determining the settle time of the synthesizer. The two options are a programmable settle time based on the value in the Syn Lock Count register (Reg 0x38), in units of 2 μ s, or by the auto detection of the synthesizer lock. 1 = Synthesizer settle time is based on a count in the Syn Lock Count register (Reg 0x38) 0 = Synthesizer settle time is based on the internal synthesizer lock signal It is recommended that the Auto Syn Count Select bit is set to 1 as that guarantees a consistent settle time for the synthesizer.
3	Auto PA Disable	The Auto Power Amplifier Disable bit is used to determine the method of controlling the Power Amplifier. The two options are automatically controlled by the baseband or by firmware through register writes. 1 = Register controlled PA Enable. 0 = Auto PA Enable When this bit is set to 1 the state of the PA enable is directly controlled by bit PA Enable (Reg 0x03, bit 2). It is recommended that this bit is set to 0 leaving the PA control to the baseband.
2	PA Enable	The PA Enable bit is used to enable or disable the Power Amplifier. 1 = Power Amplifier Enabled 0 = Power Amplifier Disabled This bit only applies when the Auto PA Disable bit is selected (Reg 0x03, bit 3 = 1), otherwise this bit is <i>do not care</i> .
1	Auto Syn Disable	The Auto Synthesizer Disable bit is used to determine the method of controlling the Synthesizer. The two options are automatic control by the baseband or by firmware through register writes. 1 = Register controlled Synthesizer Enable 0 = Auto Synthesizer Enable When this bit is set to 1 the state of the Synthesizer is directly controlled by bit Syn Enable (Reg 0x03, bit 0). When this bit is set to 0 the state of the Synthesizer is controlled by the Auto Syn Count Select bit (Reg 0x03, bit 4). It is recommended that this bit be set to 0 leaving the Synthesizer control to the baseband.
0	Syn Enable	The Synthesizer Enable bit is used to enable or disable the Synthesizer. 1 = Synthesizer Enabled 0 = Synthesizer Disabled This bit only applies when Auto Syn Disable bit is selected (Reg 0x03, bit 1 = 1), otherwise this bit is <i>do not care</i> .

Table 7. Data Rate

Addr: 0x04		REG_DATA_RATE				Default: 0x00	
7	6	5	4	3	2	1	0
Reserved					Code Width	Data Rate	Sample Rate

Bit	Name	Description
7:3	Reserved	These bits are reserved and should be written with zeros.
2 ⁽¹⁾	Code Width	<p>The Code Width bit is used to select between 32 chips/bit and 64 chips/bit PN codes.</p> <p>1 = 32 chips/bit PN codes 0 = 64 chips/bit PN codes</p> <p>The number of chips/bit used impacts a number of factors such as data throughput, range and robustness to interference. By choosing a 32 chips/bit PN-code, the data throughput can be doubled or even quadrupled (when double data rate is set). A 64 chips/bit PN code offers improved range over its 32 chips/bit counterpart as well as more robustness to interference. By selecting to use a 32 chips/bit PN code a number of other register bits are impacted and need to be addressed. These are PN Code Select (Reg 0x03, bit 5), Data Rate (Reg 0x04, bit 1), and Sample Rate (Reg 0x04, bit 0).</p>
1 ⁽¹⁾	Data Rate	<p>The Data Rate bit allows the user to select a Double Data Rate mode of operation which delivers a raw data rate of 62.5 kbits/sec.</p> <p>1 = Double Data Rate - 2 bits per PN code (No odd bit transmissions) 0 = Normal Data Rate - 1 bit per PN code</p> <p>This bit is applicable only when using 32 chips/bit PN codes which can be selected by setting the Code Width bit (Reg 0x04, bit 2 = 1). When using the Double Data Rate, the raw data throughput is 62.5 kbits/s because every 32 chips/bit PN code is interpreted as 2 bits of data. When using this mode a single 64 chips/bit PN code is placed in the PN code register. This 64 chips/bit PN code is then split into two and used by the baseband to offer the Double Data Rate capability. When using the Normal Data Rate, the raw data throughput is 32 kbits/sec. Additionally, Normal Data Rate enables the user to potentially correlate data using two differing 32 chips/bit PN codes.</p>
0 ⁽¹⁾	Sample Rate	<p>The Sample Rate bit allows the use of the 12 × sampling when using 32 chips/bit PN codes and the Normal Data Rate.</p> <p>1 = 12 × Oversampling 0 = 6 × Oversampling</p> <p>Using 12 × oversampling improves the correlators receive sensitivity. When using 64 chips/bit PN codes or the Double Data Rate this bit is <i>do not care</i>. When in the Normal Data Rate setting and choosing 12 × oversampling, eliminates the ability to receive from two different PN codes. Therefore the only time when 12 × oversampling is to be selected is when a 32 chips/bit PN code is being used and there is no need to receive data from sources with two different PN codes.</p>

Note: 1. The following Reg 0x04, bits 2:0 values are not valid:

- 001-Not Valid
- 010-Not Valid
- 011-Not Valid
- 111-Not Valid



Table 8. Configuration

Addr: 0x05			REG_CONFIG				Default: 0x01	
7	6	5	4	3	2	1	0	
Reserved			Receive Invert	Transmit Invert	Reserved	IRQ Pin Select		

Bit	Name	Description
7:5	Reserved	These bits are reserved and should be written with zeros.
4	Receive Invert	The Receive Invert bit is used to invert the received data. 1 = Inverted over-the-air Receive data 0 = Non-inverted over-the-air Receive data
3	Transmit Invert	The Transmit Invert bit is used to invert the data that is to be transmitted. 1 = Inverted Transmit Data 0 = Non-inverted Transmit Data
2	Reserved	This bit is reserved and should be written with zero.
1:0	IRQ Pin Select	The Interrupt Request Pin Select bits are used to determine the drive method of the IRQ pin. 11 = Open Drain (asserted = 0, deasserted = Hi-Z) 10 = Open Source (asserted = 1, deasserted = Hi-Z) 01 = CMOS (asserted = 1, deasserted = 0) 00 = CMOS Inverted (asserted = 0, deasserted = 1)

Table 9. SERDES Control

Addr: 0x06			REG_SERDES_CTL				Default: 0x03	
7	6	5	4	3	2	1	0	
Reserved				SERDES Enable	EOF Length			

Bit	Name	Description
7:4	Reserved	These bits are reserved and should be written with zeros.
3	SERDES Enable	The SERDES Enable bit is used to switch between bit-serial mode and SERDES mode. 1 = SERDES enabled 0 = SERDES disabled, bit-serial mode enabled When the SERDES is enabled data can be written to and read from the IC one byte at a time through the use of the SERDES Data registers. The bit-serial mode requires bits to be written one bit at a time through the use of the DIO/DIOVAL pins. It is recommended that the SERDES mode be used to avoid the need to manage the timing required by the bit-serial mode.
2:0	EOF Length	The End of Frame Length bits are used to set the number of sequential bit times for an inter-frame gap without valid data before an EOF event is generated. When in receive mode and a valid bit has been received the EOF event can then be identified by the number of bit times that expire without correlating any new data. The EOF event causes data to be moved to the proper SERDES Data Register and can also be used to generate interrupts. If 0 is the EOF length, an EOF condition will occur at the first invalid bit after a valid reception.

Table 10. Receive Interrupt Enable

Addr: 0x07			REG_RX_INT_EN				Default: 0x00	
7	6	5	4	3	2	1	0	
Underflow B	Overflow B	EOF B	Full B	Underflow A	Overflow A	EOF A	Full A	

Bit	Name	Description
7	Underflow B	The Underflow B bit is used to enable the interrupt associated with an underflow condition with the Receive SERDES Data B register (Reg 0x0B) 1 = Underflow B interrupt enabled for Receive SERDES Data B 0 = Underflow B interrupt disabled for Receive SERDES Data B An underflow condition occurs when attempting to read the Receive SERDES Data B register (Reg 0x0B) when it is empty.
6	Overflow B	The Overflow B bit is used to enable the interrupt associated with an overflow condition with the Receive SERDES Data B register (Reg 0x0B) 1 = Overflow B interrupt enabled for Receive SERDES Data B 0 = Overflow B interrupt disabled for Receive SERDES Data B An overflow condition occurs when new received data is written into the Receive SERDES Data B register (Reg 0x0B) before the prior data is read out.
5	EOF B	The End of Frame B bit is used to enable the interrupt associated with the Channel B Receiver EOF condition. 1 = EOF B interrupt enabled for Channel B Receiver 0 = EOF B interrupt disabled for Channel B Receiver The EOF IRQ asserts during an End of Frame condition. End of Frame conditions occur after at least one bit has been detected, and then the number of invalid bits in the frame exceeds the number in the EOF length field. If 0 is the EOF length, and EOF condition will occur at the first invalid bit after a valid reception. This IRQ is cleared by reading the receive status register
4	Full B	The Full B bit is used to enable the interrupt associated with the Receive SERDES Data B register (Reg 0x0B) having data placed in it. 1 = Full B interrupt enabled for Receive SERDES Data B 0 = Full B interrupt disabled for Receive SERDES Data B A Full B condition occurs when data is transferred from the Channel B Receiver into the Receive SERDES Data B register (Reg 0x0B). This could occur when a complete byte is received or when an EOF event occurs whether or not a complete byte has been received.
3	Underflow A	The Underflow A bit is used to enable the interrupt associated with an underflow condition with the Receive SERDES Data A register (Reg 0x09) 1 = Underflow A interrupt enabled for Receive SERDES Data A 0 = Underflow A interrupt disabled for Receive SERDES Data A An underflow condition occurs when attempting to read the Receive SERDES Data A register (Reg 0x09) when it is empty.
2	Overflow A	The Overflow A bit is used to enable the interrupt associated with an overflow condition with the Receive SERDES Data A register (0x09) 1 = Overflow A interrupt enabled for Receive SERDES Data A 0 = Overflow A interrupt disabled for Receive SERDES Data A An overflow condition occurs when new receive data is written into the Receive SERDES Data A register (Reg 0x09) before the prior data is read out.
1	EOF A	The End of Frame A bit is used to enable the interrupt associated with an End of Frame condition with the Channel A Receiver. 1 = EOF A interrupt enabled for Channel A Receiver 0 = EOF A interrupt disabled for Channel A Receiver The EOF IRQ asserts during an End of Frame condition. End of Frame conditions occur after at least one bit has been detected, and then the number of invalid bits in a frame exceeds the number in the EOF length field. If 0 is the EOF length, an EOF condition will occur at the first invalid bit after a valid reception. This IRQ is cleared by reading the receive status register.
0	Full A	The Full A bit is used to enable the interrupt associated with the Receive SERDES Data A register (0x09) having data written into it. 1 = Full A interrupt enabled for Receive SERDES Data A 0 = Full A interrupt disabled for Receive SERDES Data A A Full A condition occurs when data is transferred from the Channel A Receiver into the Receive SERDES Data A register (Reg 0x09). This could occur when a complete byte is received or when an EOF event occurs whether or not a complete byte has been received.

Table 11. Receive Interrupt Status

Addr: 0x08		REG_RX_INT_STAT				Default: 0x00	
7	6	5	4	3	2	1	0
Valid B	Flow Violation B	EOF B	Full B	Valid A	Flow Violation A	EOF A	Full A

Note: All status bits are set and readable in the registers regardless of IRQ enable status. This allows a polling scheme to be implemented without enabling IRQs. The status bits are affected by the TX Enable and RX Enable (Reg 0x03, bits 7:6). For example, the receive status will read 0 if the IC is not in receive mode. These register are read-only.

Bit	Name	Description
7	Valid B	The Valid B bit is true when all the bits in the Receive SERDES Data B register (Reg 0x0B) are valid. 1 = All bits are valid for Receive SERDES Data B 0 = Not all bits are valid for Receive SERDES Data B When data is written into the Receive SERDES Data B register (Reg 0x0B) this bit is set if all of the bits within the byte that has been written are valid. This bit cannot generate an interrupt.
6	Flow Violation B	The Flow Violation B bit is used to signal whether an overflow or underflow condition has occurred for the Receive SERDES Data B register (Reg 0x0B). 1 = Overflow/underflow interrupt pending for Receive SERDES Data B 0 = No overflow/underflow interrupt pending for Receive SERDES Data B Overflow conditions occur when the radio loads new data into the Receive SERDES Data B register (Reg 0x0B) before the prior data has been read. Underflow conditions occur when trying to read the Receive SERDES Data B register (Reg 0x0B) when the register is empty. This bit is cleared by reading the Receive Interrupt Status register (Reg 0x08)
5	EOF B	The End of Frame B bit is used to signal whether an EOF event has occurred on the Channel B receive. 1 = EOF interrupt pending for Channel B 0 = No EOF interrupt pending for Channel B An EOF condition occurs for the Channel B Receiver when receive has begun and then the number of bit times specified in the SERDES Control register (Reg 0x06) elapse without any valid bits being received. This bit is cleared by reading the Receive Interrupt Status register (Reg 0x08)
4	Full B	The Full B bit is used to signal when the Receive SERDES Data B register (Reg 0x0B) is filled with data. 1 = Receive SERDES Data B full interrupt pending 0 = No Receive SERDES Data B full interrupt pending A Full B condition occurs when data is transferred from the Channel B Receiver into the Receive SERDES Data B register (Reg 0x0B). This could occur when a complete byte is received or when an EOF event occurs whether or not a complete byte has been received.
3	Valid A	The Valid A bit is true when all of the bits in the Receive SERDES Data A Register (Reg 0x09) are valid. 1 = All bits are valid for Receive SERDES Data A 0 = Not all bits are valid for Receive SERDES Data A When data is written into the Receive SERDES Data A register (Reg 0x09) this bit is set if all of the bits within the byte that has been written are valid. This bit cannot generate an interrupt.
2	Flow Violation A	The Flow Violation A bit is used to signal whether an overflow or underflow condition has occurred for the Receive SERDES Data A register (Reg 0x09). 1 = Overflow/underflow interrupt pending for Receive SERDES Data A 0 = No overflow/underflow interrupt pending for Receive SERDES Data A Overflow conditions occur when the radio loads new data into the Receive SERDES Data A register (Reg 0x09) before the prior data has been read. Underflow conditions occur when trying to read the Receive SERDES Data A register (Reg 0x09) when the register is empty. This bit is cleared by reading the Receive Interrupt Status register (Reg 0x08)

- 1 EOF A The End of Frame A bit is used to signal whether an EOF event has occurred on the Channel A receive.
 1 = EOF interrupt pending for Channel A
 0 = No EOF interrupt pending for Channel A
 An EOF condition occurs for the Channel A Receiver when receive has begun and then the number of bit times specified in the SERDES Control register (0x06) elapse without any valid bits being received. This bit is cleared by reading the Receive Interrupt Status register (Reg 0x08).

- 0 Full A The Full A bit is used to signal when the Receive SERDES Data A register (Reg 0x09) is filled with data.
 1 = Receive SERDES Data A full interrupt pending
 0 = No Receive SERDES Data A full interrupt pending
 A Full A condition occurs when data is transferred from the Channel A Receiver into the Receive SERDES Data A Register (Reg 0x09). This could occur when a complete byte is received or when an EOF event occurs whether or not a complete byte has been received.

Table 12. Receive SERDES Data A

Addr: 0x09			REG_RX_DATA_A				Default: 0x00	
7	6	5	4	3	2	1	0	
Data								

Bit Name Description

7:0 Data Received Data for Channel A. The over-the-air received order is bit 0 followed by bit 1, followed by bit 2, followed by bit 3, followed by bit 4, followed by bit 5, followed by bit 6, followed by bit 7. This register is read-only.

Table 13. Receive SERDES Valid A

Addr: 0x0A			REG_RX_VALID_A				Default: 0x00	
7	6	5	4	3	2	1	0	
Valid								

Bit Name Description

7:0 Valid These bits indicate which of the bits in the Receive SERDES Data A register (Reg 0x09) are valid. A "1" indicates that the corresponding data bit is valid for Channel A.
 If the Valid Data bit is set in the Receive Interrupt Status register (Reg 0x08) all eight bits in the Receive SERDES Data A register (Reg 0x09) are valid. Therefore, it is not necessary to read the Receive SERDES Valid A register (Reg 0x0A). The over-the-air received order is bit 0 followed by bit 1, followed by bit 2, followed by bit 3, followed by bit 4, followed by bit 5, followed by bit 6, followed by bit 7. This register is read-only.

Table 14. Receive SERDES Data B

Addr: 0x0B			REG_RX_DATA_B				Default: 0x00	
7	6	5	4	3	2	1	0	
Data								

Bit Name Description

7:0 Data Received Data for Channel B. The over-the-air received order is bit 0 followed by bit 1, followed by bit 2, followed by bit 3, followed by bit 4, followed by bit 5, followed by bit 6, followed by bit 7. This register is read-only.

Table 15. Receive SERDES Valid B

Addr: 0x0C		REG_RX_VALID_B				Default: 0x00	
7	6	5	4	3	2	1	0
Valid							

Bit	Name	Description
7:0	Valid	These bits indicate which of the bits in the Receive SERDES Data B register (Reg 0x0B) are valid. A “1” indicates that the corresponding data bit is valid for Channel B. If the Valid Data bit is set in the Receive Interrupt Status register (0x08) all eight bits in the Receive SERDES Data B register (Reg 0x0B) are valid. Therefore, it is not necessary to read the Receive SERDES Valid B register (Reg 0x0C).The over-the-air received order is bit 0 followed by bit 1, followed by bit 2, followed by bit 3, followed by bit 4, followed by bit 5, followed by bit 6, followed by bit 7. This register is read-only.

Table 16. Transmit Interrupt Enable

Addr: 0x0D		REG_TX_INT_EN				Default: 0x00	
7	6	5	4	3	2	1	0
Reserved				Underflow	Overflow	Done	Empty

Bit	Name	Description
7:4	Reserved	These bits are reserved and should be written with zeros.
3	Underflow	The Underflow bit is used to enable the interrupt associated with an underflow condition associated with the Transmit SERDES Data register (Reg 0x0F) 1 = Underflow interrupt enabled 0 = Underflow interrupt disabled An underflow condition occurs when attempting to transmit while the Transmit SERDES Data register (Reg 0x0F) does not have any data.
2	Overflow	The Overflow bit is used to enabled the interrupt associated with an overflow condition with the Transmit SERDES Data register (0x0F). 1 = Overflow interrupt enabled 0 = Overflow interrupt disabled An overflow condition occurs when attempting to write new data to the Transmit SERDES Data register (Reg 0x0F) before the preceding data has been transferred to the transmit shift register.
1	Done	The Done bit is used to enable the interrupt that signals the end of the transmission of data. 1 = Done interrupt enabled 0 = Done interrupt disabled The Done condition occurs when the Transmit SERDES Data register (Reg 0x0F) has transmitted all of its data and there is no more data for it to transmit.
0	Empty	The Empty bit is used to enable the interrupt that signals when the Transmit SERDES register (Reg 0x0F) is empty. 1 = Empty interrupt enabled 0 = Empty interrupt disabled The Empty condition occurs when the Transmit SERDES Data register (Reg 0x0F) is loaded into the transmit buffer and it's safe to load the next byte

Table 17. Transmit Interrupt Status

Addr: 0x0E		REG_TX_INT_STAT				Default: 0x00	
7	6	5	4	3	2	1	0
Reserved				Underflow	Overflow	Done	Empty

Note: All status bits are set and readable in the registers regardless of IRQ enable status. This allows a polling scheme to be implemented without enabling IRQs. The status bits are affected by the TX Enable and RX Enable (Reg 0x03, bits 7:6). For example, the transmit status will read 0 if the IC is not in transmit mode. These registers are read-only.

Bit	Name	Description
7:4	Reserved	These bits are reserved. This register is read-only.
3	Underflow	<p>The Underflow bit is used to signal when an underflow condition associated with the Transmit SERDES Data register (Reg 0x0F) has occurred.</p> <p>1 = Underflow Interrupt pending 0 = No Underflow Interrupt pending</p> <p>This IRQ will assert during an underflow condition to the Transmit SERDES Data register (Reg 0x0F). An underflow occurs when the transmitter is ready to sample transmit data, but there is no data ready in the Transmit SERDES Data register (Reg 0x0F). This will only assert after the transmitter has transmitted at least one bit. This bit is cleared by reading the Transmit Interrupt Status register (Reg 0x0E).</p>
2	Overflow	<p>The Overflow bit is used to signal when an overflow condition associated with the Transmit SERDES Data register (0x0F) has occurred.</p> <p>1 = Overflow Interrupt pending 0 = No Overflow Interrupt pending</p> <p>This IRQ will assert during an overflow condition to the Transmit SERDES Data register (Reg 0x0F). An overflow occurs when the new data is loaded into the Transmit SERDES Data register (Reg 0x0F) before the previous data has been sent. This bit is cleared by reading the Transmit Interrupt Status register (Reg 0x0E).</p>
1	Done	<p>The Done bit is used to signal the end of a data transmission.</p> <p>1 = Done Interrupt pending 0 = No Done Interrupt pending</p> <p>This IRQ will assert when the data is finished sending a byte of data and there is no more data to be sent. This will only assert after the transmitter has transmitted as least one bit. This bit is cleared by reading the Transmit Interrupt Status register (Reg 0x0E)</p>
0	Empty	<p>The Empty bit is used to signal when the Transmit SERDES Data register (Reg 0x0F) has been emptied.</p> <p>1 = Empty Interrupt pending 0 = No Empty Interrupt pending</p> <p>This IRQ will assert when the transmit SERDES is empty. When this IRQ is asserted it is ok to write to the Transmit SERDES Data register (Reg 0x0F). Writing the Transmit SERDES Data register (Reg 0x0F) will clear this IRQ. It will be set when the data is loaded into the transmitter, and it is ok to write new data.</p>

Note: 1. All status bits are set and readable in the registers regardless of IRQ enable status. This allows a polling scheme to be implemented without enabling IRQs. The status bits are affected by the TX Enable and RX Enable (Reg 0x03, bits 7:6). For example, the transmit status will read 0 if the IC is not in transmit mode. These registers are read-only.

Table 18. Transmit SERDES Data

Addr: 0x0F				REG_TX_DATA				Default: 0x00			
7	6	5	4	3	2	1	0				
Data											

Bit Name Description

7:0 Data Transmit Data. The over-the-air transmitted order is bit 0 followed by bit 1, followed by bit 2, followed by bit 3, followed by bit 4, followed by bit 5, followed by bit 6, followed by bit 7.

Table 19. Transmit SERDES Valid

Addr: 0x10				REG_TX_VALID				Default: 0x00			
7	6	5	4	3	2	1	0				
Valid											

Bit Name Description

7:0 Valid⁽¹⁾ The Valid bits are used to determine which of the bits in the Transmit SERDES Data register (reg 0x0F) are valid.
 1 = Valid transmit bit
 0 = Invalid transmit bit

Note: 1. The Valid bit in the Transmit SERDES Valid register (Reg 0x10) is used to mark whether the radio will send data or preamble during that bit time of the data byte. Data is sent LSB first. The SERDES will continue to send data until there are no more VALID bits in the shifter. For example, writing 0x0F to the Transmit SERDES Valid register (Reg 0x10) will send half a byte.

Table 20. PN Code

Addr: 0x11-18																REG_PN_CODE																Default: 0x1E8B6A3DE0E9B222							
63	62	61	60	59	58	57	56	55	54	53	52	51	50	49	48	47	46	45	44	43	42	41	40	39	38	37	36	35	34	33	32								
Address 0x18								Address 0x17								Address 0x16								Address 0x15															

31	30	29	28	27	26	25	24	23	22	21	20	19	18	17	16	15	14	13	12	11	10	9	8	7	6	5	4	3	2	1	0
Address 0x14								Address 0x13								Address 0x12								Address 0x11							

Bit Name Description

63:0 PN Codes The value inside the 8 byte PN code register is used as the spreading code for DSSS communication. All 8 bytes can be used together for 64 chips/bit PN code communication, or the registers can be split into two sets of 32 chips/bit PN codes and these can be used alone or with each other to accomplish faster data rates. Not any 64 chips/bit value can be used as a PN code as there are certain characteristics that are needed to minimize the possibility of multiple PN codes interfering with each other or the possibility of invalid correlation. The over-the-air order is bit 0 followed by bit 1, followed by bit 62, followed by bit 63.

Table 21. Threshold Low

Addr: 0x19		REG_THRESHOLD_L						Default: 0x08
7	6	5	4	3	2	1	0	
Reserved	Threshold Low							

Bit	Name	Description
7	Reserved	This bit is reserved and should be written with zero.
6:0	Threshold Low	The Threshold Low value is used to determine the number of missed chips allowed when attempting to correlate a single data bit of value 0. A perfect reception of a data bit of 0 with a 64 chips/bit PN code would result in zero correlation matches, meaning the exact inverse of the PN code has been received. By setting the Threshold Low value to 0x08 for example, up to eight chips can be erroneous while still identifying the value of the received data bit. This value along with the Threshold High value determine the correlator count values for logic 1 and logic 0. The threshold values used determine the sensitivity of the receiver to interference and the dependability of the received data. By allowing a minimal number of erroneous chips the dependability of the received data increases while the robustness to interference decreases. On the other hand increasing the maximum number of missed chips means reduced data integrity but increased robustness to interference and increased range.

Table 22. Threshold High

Addr: 0x1A		REG_THRESHOLD_H						Default: 0x38
7	6	5	4	3	2	1	0	
Reserved	Threshold High							

Bit	Name	Description
7	Reserved	This bit is reserved and should be written with zero.
6:0	Threshold High	The Threshold High value is used to determine the number of matched chips allowed when attempting to correlate a single data bit of value 1. A perfect reception of a data bit of 1 with a 64 chips/bit or a 32 chips/bit PN code would result in 64 chips/bit or 32 chips/bit correlation matches, respectively, meaning every bit was received perfectly. By setting the Threshold High value to 0x38 (64-8) for example, up to eight chips can be erroneous while still identifying the value of the received data bit. This value along with the Threshold Low value determine the correlator count values for logic 1 and logic 0. The threshold values used determine the sensitivity of the receiver to interference and the dependability of the received data. By allowing a minimal number of erroneous chips the dependability of the received data increases while the robustness to interference decreases. On the other hand increasing the maximum number of missed chips means reduced data integrity but increased robustness to interference and increased range.

Table 23. Wake Enable

Addr: 0x1C		REG_WAKE_EN					Default: 0x00	
7	6	5	4	3	2	1	0	
Reserved							Wake-up Enable	

Bit	Name	Description
7:1	Reserved	These bits are reserved and should be written with zeros.
0	Wake-up Enable	Wake-up interrupt enable. 0 = Disabled 1 = Enabled A wake-up event is triggered when the \overline{PD} pin is deasserted and once the IC is ready to receive SPI communications.

Table 24. Wake Status

Addr: 0x1D		REG_WAKE_STAT					Default: 0x01	
7	6	5	4	3	2	1	0	
Reserved							Wake-up Status	

Bit	Name	Description
7:1	Reserved	These bits are reserved. This register is read-only.
0	Wake-up Status	Wake-up status. 0 = Wake interrupt not pending 1 = Wake interrupt pending This IRQ will assert when a wake-up condition occurs. This bit is cleared by reading the Wake Status register (Reg 0x1D). This register is read-only.

Table 25. Analog Control

Addr: 0x20		REG_ANALOG_CTL				Default: 0x00	
7	6	5	4	3	2	1	0
Reserved	AGC Disable	MID Read Enable	Reserved	Reserved	PA Output Enable	Palnv	Rst

Bit	Name	Description
7	Reserved	This bit is reserved and should be written with zero.
6	AGC RSSI Control	Enables AGC/RSSI control via Reg 0x2E and Reg 0x2F.
5	MID Read Enable	The MID Read Enable bit must be set to read the contents of the Manufacturing ID register (Reg 0x3C-0x3F). Enabling the Manufacturing ID register (Reg 0x3C-0x3F) consumes power. This bit should only be set when reading the contents of the Manufacturing ID register (Reg 0x3C-0x3F).
4:3	Reserved	These bits are reserved and should be written with zeros.
2	PA Output Enable	The Power Amplifier Output Enable bit is used to enable the PACTL pin for control of an external power amplifier. 1 = PA Control Output Enabled on PACTL pin 0 = PA Control Output Disabled on PACTL pin
1	PA Invert	The Power Amplifier Invert bit is used to specify the polarity of the PACTL signal when the PaOe bit is set high. PA Output Enable and PA Invert cannot be simultaneously changed. 1 = PACTL active low 0 = PACTL active high
0	Reset	The Reset bit is used to generate a self clearing device reset. 1 = Device Reset. All registers are restored to their default values 0 = No Device Reset

Table 26. Channel

Addr: 0x21		REG_CHANNEL				Default: 0x00	
7	6	5	4	3	2	1	0
A+N	Channel						

Bit	Name	Description
7	A+N	The A+N bit is used to specify whether the Synthesizer frequency is generated through the use of the Channel register (Reg 0x21) or through the use of the Synthesizer A Counter register (Reg 0x01) and the Synthesizer N Counter register (Reg 0x02). 1 = Synthesizer A Counter register (Reg 0x01) and the Synthesizer N Counter register (Reg 0x02) registers used to generate Synthesizer frequency 0 = Channel register (Reg 0x21) is used to generate Synthesizer frequency When set to 1 the channel value is ignored and the values written in the Synthesizer A Counter register (Reg 0x01) and the Synthesizer N Counter register (Reg 0x02) are used. When set to 0 the values written to the Synthesizer A Counter register (Reg 0x01) and the Synthesizer N Counter register (Reg 0x02) are ignored and the channel value is used by the synthesizer. It is recommended that the Channel register (Reg 0x21) is used as opposed to the Synthesizer A Counter register (Reg 0x01) and the Synthesizer N Counter register (Reg 0x02) method.
6:0	Channel	The Channel register (Reg 0x21) is used to determine the Synthesizer frequency when the A+N bit is set to 0. Use of other channels may be restricted by certain regulatory agencies. A value of 1 corresponds to a communication frequency of 2.402 GHz, while a value of 79 corresponds to a frequency of 2.479 GHz. The channels are separated from each other by 1 MHz intervals.

Table 27. Receive Signal Strength Indicator (RSSI)

Addr: 0x22		REG_RSSI				Default: 0x00	
7	6	5	4	3	2	1	0
Reserved		Valid		RSSI			

Note: The RSSI will collect a single value each time the part is put into receive mode via Control register (Reg 0x03, bit 7 = 1).

Bit	Name	Description
7:6	Reserved	These bits are reserved. This register is read-only.
5	Valid	The Valid bit indicates whether the RSSI value in bits [4:0] are valid. This register is read only. 1 = RSSI value is valid 0 = RSSI value is invalid
4:0	RSSI	The Receive Strength Signal Indicator (RSSI) value indicates the strength of the received signal. This is a read only value with the higher values indicating stronger received signals meaning more reliable transmissions.

Table 28. Power Control

Addr: 0x23		REG_PA				Default: 0x00	
7	6	5	4	3	2	1	0
Reserved					PA Bias		

Bit	Name	Description
7:3	Reserved	These bits are reserved and should be written with zeros.
2:0	PA Bias	The Power Amplifier Bias (PA Bias) bits are used to set the transmit power of the IC through increasing (values up to 7) or decreasing (values down to 0) the gain of the on-chip Power Amplifier. The higher the register value the higher the transmit power. By changing the PA Bias value signal strength management functions can be accomplished. For general purpose communication a value of 7 is recommended.

Table 29. Crystal Adjust

Addr: 0x24		REG_CRYSTAL_ADJ				Default: 0x00	
7	6	5	4	3	2	1	0
Reserved	Clock Output Disable	Crystal Adjust					

Bit	Name	Description
7	Reserved	This bit is reserved and should be written with zero.
6	Clock Output Disable	The Clock Output Disable bit disables the 13 MHz clock driven on the X13OUT pin. 1 = No 13 MHz clock driven externally 0 = 13 MHz clock driven externally If the 13 MHz clock is driven on the X13OUT pin then receive sensitivity will be reduced by -4 dBm on channels 5+13n. By default the 13 MHz clock output pin is enabled. This pin is useful for adjusting the 13 MHz clock, but it interferes with every 13th channel beginning with 2.405 GHz channel. Therefore, it is recommended that the 13 MHz clock output pin be disabled when not in use.
5:0	Crystal Adjust	The Crystal Adjust value is used to calibrate the on-chip load capacitance supplied to the crystal. The Crystal Adjust value will depend on the parameters of the crystal being used. Refer to the appropriate reference material for information about choosing the optimum Crystal Adjust value.

Table 30. VCO Calibration

Addr: 0x26		REG_VCO_CAL						Default: 0x00
7	6	5	4	3	2	1	0	
VCO Slope Enable		Reserved						

Bit	Name	Description
7:6	VCO Slope Enable (Write-Only)	The Voltage Controlled Oscillator (VCO) Slope Enable bits are used to specify the amount of variance automatically added to the VCO. 11 = -5/+5 VCO adjust. The application MCU must configure this option during initialization 10 = -2/+3 VCO adjust 01 = Reserved 00 = No VCO adjust These bits are undefined for read operations.
5:0	Reserved	These bits are reserved and should be written with zeros.

Table 31. AGC Control

Addr: 0x2E		REG_AGC_CTL						Default: 0x00
7	6	5	4	3	2	1	0	
AGC Lock		Reserved						

Bit	Name	Description
7	AGC Lock	When set, this bit disables the on-chip LNA AGC system, powers down unused circuitry, and locks the LNA to maximum gain. The user must set Reg 20, bit 6 = 1 to enable writes to Reg 0x2E. It is recommended this bit be set during initialization to save power.
6:0	Reserved	These bits are reserved and should be written with zeros.

Table 32. Carrier Detect

Addr: 0x2F		REG_CARRIER_DETECT						Default: 0x00
7	6	5	4	3	2	1	0	
Carrier Detect Override		Reserved						

Bit	Name	Description
7	Carrier Detect Override	When set, this bit overrides the carrier detect. The user must set Reg 20, bit 6 = 1 to enable writes to Reg 0x2F.
6:0	Reserved	These bits are reserved and should be written with zeros.

Table 33. Clock Manual

Addr: 0x32		REG_CLOCK_MANUAL						Default: 0x00	
7	6	5	4	3	2	1	0		
Manual Clock Overrides									

Bit	Name	Description
7:0	Manual Clock Overrides	This register must be written with 0x41 after reset for correct operation

Table 34. Clock Enable

Addr: 0x33		REG_CLOCK_ENABLE						Default: 0x00	
7	6	5	4	3	2	1	0		
Manual Clock Enables									

Bit	Name	Description
7:0	Manual Clock Enables	This register must be written with 0x41 after reset for correct operation

Table 35. Synthesizer Lock Count

Addr: 0x38		REG_SYN_LOCK_CNT						Default: 0x64	
7	6	5	4	3	2	1	0		
Count									

Bit	Name	Description
7:0	Count	Determines the length of delay in 2 μ s increments for the synthesizer to lock when auto synthesizer is enabled via Control register (0x03, bit 1 = 0) and not using the PLL lock signal.

Table 36. Manufacturing ID

Addr: 0x3C-3F																REG_MID															
31	30	29	28	27	26	25	24	23	22	21	20	19	18	17	16	15	14	13	12	11	10	9	8	7	6	5	4	3	2	1	0
Address 0x3F								Address 0x3E								Address 0x3D								Address 0x3C							

Bit	Name	Description
31:0	Address[31:0]	These bits are the Manufacturing ID (MID) for each IC. The contents of these bits cannot be read unless the MID Read Enable bit (bit 5) is set in the Analog Control register (Reg 0x20). Enabling the Manufacturing ID register (Reg 0x3C-0x3F) consumes power. The MID Read Enable bit in the Analog Control register (Reg 0x20, bit 5) should only be set when reading the contents of the Manufacturing ID register (Reg 0x3C to 0x3F). This register is read-only.

Absolute Maximum Ratings

Stresses beyond those listed under “Absolute Maximum Ratings” may cause permanent damage to the device. This is a stress rating only and functional operation of the device at these or any other conditions beyond those indicated in the operational sections of this specification is not implied. Exposure to absolute maximum rating conditions for extended periods may affect device reliability.

Parameters	Pin	Symbol	Value	Unit
Storage temperature			-65 to +150	°C
Ambient temperature with power applied			-55 to +125	°C
Supply voltage on V_{CC} relative to V_{SS}			-0.3 to +3.9	V
DC voltage to logic inputs ⁽¹⁾			-0.3 to $V_{CC}+0.3$	V
DC voltage applied to outputs in high-Z state			-0.3 to $V_{CC}+0.3$	V
Static discharge voltage (digital)			> 2000	V
Static discharge voltage (RF) ⁽²⁾			500	V
Latch-up current			+200, -200	mA

- Notes:
1. It is permissible to connect voltages above V_{CC} to inputs through a series resistor limiting input current to 1 mA. This cannot be done during power down mode. AC timing not guaranteed.
 2. Human Body Model (HBM).

Operating Conditions

Parameters	Symbol	Value	Unit
Supply voltage	V_{CC}	2.7 to 3.6	V
Ambient temperature under bias	T_A	-40 to +85	°C
Ground voltage		0	V
Oscillator or crystal frequency)	F_{OSC}	13	MHz

DC Parameters

Description	Conditions	Symbol	Min.	Typ. ⁽¹⁾	Max.	Unit
Supply voltage		V_{CC}	2.7	3.0	3.6	V
Output high voltage condition 1	At $I_{OH} = -100.0 \mu A$	V_{OH1}	$V_{CC} - 0.1$	V_{CC}		V
Output high voltage condition 2	At $I_{OH} = -2.0 \text{ mA}$	V_{OH2}	2.4	3.0		V
Output low voltage	At $I_{OL} = 2.0 \text{ mA}$	V_{OL}		0.0	0.4	V
Input high voltage		V_{IH}	2.0		$V_{CC}^{(2)}$	V
Input low voltage		V_{IL}	-0.3		+0.8	V
Input leakage current	$0 < V_{IN} < V_{CC}$	I_{IL}	-1	0.26	+1	μA
Pin input capacitance (except X13, X13IN, RFIN)		C_{IN}		3.5	10	pF
Current consumption during power-down mode	$\overline{PD} = \text{LOW}$	I_{Sleep}		0.24	10	μA
Current consumption without synthesizer	$\overline{PD} = \text{HIGH}$	IDLE I_{CC}		3		mA
I_{CC} from \overline{PD} high to oscillator stable		STARTUP I_{CC}		1.8		mA
Average transmitter current consumption ⁽³⁾	No handshake	TX AVG I_{CC1}		5.9		mA
Average transmitter current consumption ⁽⁴⁾	With handshaking	TX AVG I_{CC2}		8.1		mA
Current consumption during receive		RX I_{CC} (PEAK)		57.7		mA
Current consumption during transmit		TX I_{CC} (PEAK)		69.1		mA
Current consumption with synthesizer on, no transmit or receive		SYNTH SETTLE I_{CC}		28.7		mA

- Notes:
1. Typical values measured with $V_{CC} = 3.0 \text{ V}$ at 25°C .
 2. It is permissible to connect voltages above V_{CC} to inputs through a series resistor limiting input current to 1 mA.
 3. Average I_{CC} when transmitting a 5-byte packet (3 data bytes + 2 bytes of protocol) every 10 ms using the WirelessUSB 1-way protocol.
 4. Average I_{CC} when transmitting a 5-byte packet (3 data bytes + 2 bytes of protocol) every 10 ms using the WirelessUSB 2-way protocol.

AC Characteristics⁽¹⁾: SPI Interface⁽³⁾

Description	Parameter	Min.	Typ.	Max.	Unit
SPI clock period	t_{SCK_CYC}	476			ns
SPI clock high time	t_{SCK_HI} (BURST READ) ⁽²⁾	238			ns
SPI clock high time	t_{SCK_HI}	158			ns
SPI clock low time	t_{SCK_LO}	158			ns
SPI input data set-up time	t_{DAT_SU}	10			ns
SPI input data hold time	t_{DAT_HLD}	97 ⁽³⁾			ns
SPI output data valid time	t_{DAT_VAL}	77 ⁽³⁾		174 ⁽³⁾	ns
SPI slave select set-up time before first positive edge of SCK ⁽⁴⁾	t_{SS_SU}	250			ns
SPI slave select hold time after last negative edge of SCK	t_{SS_HLD}	80			ns

- Notes:
1. AC values are not guaranteed if voltages on any pin exceed V_{CC} .
 2. This stretch only applies to every 9th SCK HI pulse for SPI burst reads only.
 3. For $F_{OSC} = 13\text{ MHz}$, 3.3 V at 25°C.
 4. SCK must start low, otherwise the success of SPI transactions are not guaranteed.

Figure 9. SPI Timing Diagram

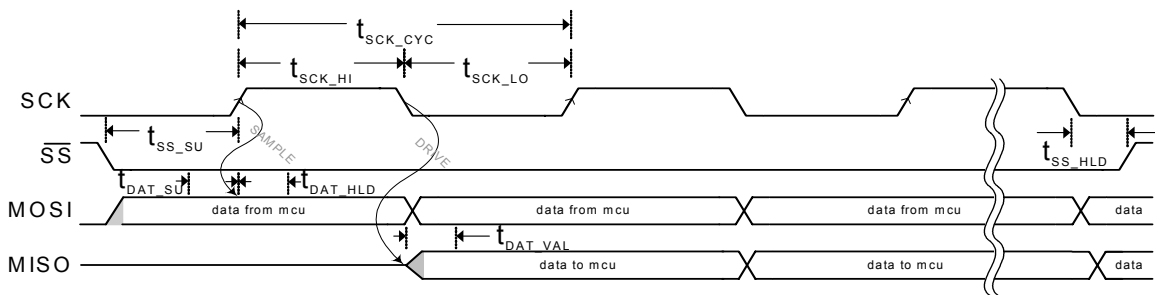
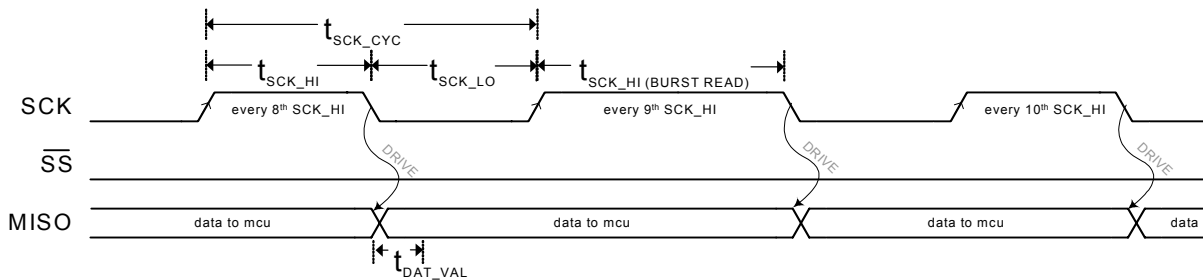


Figure 10. SPI Burst Read Every 9th SCK HI Stretch Timing Diagram



DIO Interface

Parameter	Description	Min.	Typ.	Max.	Unit
Transmit					
$t_{TX_DIOVAL_SU}$	DIOVAL set-up time	2.1			μs
$t_{TX_DIO_SU}$	DIO set-up time	2.1			μs
$t_{TX_DIOVAL_HLD}$	DIOVAL hold time	0			μs
$t_{TX_DIO_HLD}$	DIO hold time	0			μs
$t_{TX_IRQ_HI}$	Minimum IRQ high time - 32 chips/bit DDR		8		μs
	Minimum IRQ high time - 32 chips/bit		16		μs
	Minimum IRQ high time - 64 chips/bit		32		μs
$t_{TX_IRQ_LO}$	Minimum IRQ low time - 32 chips/bit DDR		8		μs
	Minimum IRQ low time - 32 chips/bit		16		μs
	Minimum IRQ low time - 64 chips/bit		32		μs
Receive					
$t_{RX_DIOVAL_VLD}$	DIOVAL valid time - 32 chips/bit DDR	-0.01		+6.1	μs
	DIOVAL valid time - 32 chips/bit	-0.01		+8.2	μs
	DIOVAL valid time - 64 chips/bit	-0.01		+16.1	μs
$t_{RX_DIO_VLD}$	DIO valid time - 32 chips/bit DDR	-0.01		+6.1	μs
	DIO valid time - 32 chips/bit	-0.01		+8.2	μs
	DIO valid time - 64 chips/bit	-0.01		+16.1	μs
$t_{RX_IRQ_HI}$	Minimum IRQ high time - 32 chips/bit DDR		1		μs
	Minimum IRQ high time - 32 chips/bit		1		μs
	Minimum IRQ high time - 64 chips/bit		1		μs
$t_{RX_IRQ_LO}$	Minimum IRQ low time - 32 chips/bit DDR		8		μs
	Minimum IRQ low time - 32 chips/bit		16		μs
	Minimum IRQ low time - 64 chips/bit		32		μs

Figure 11. DIO Receive Timing Diagram

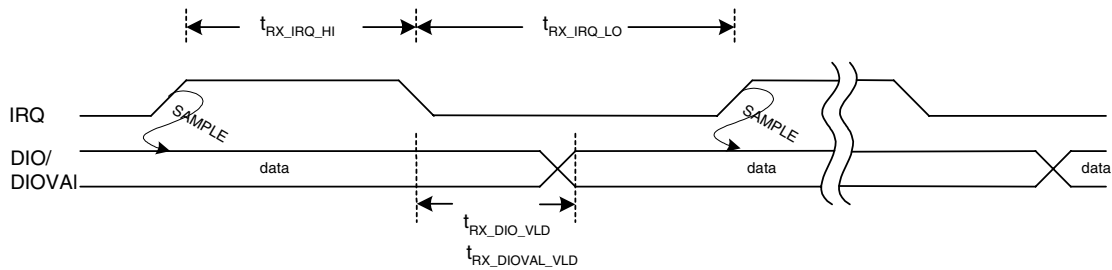
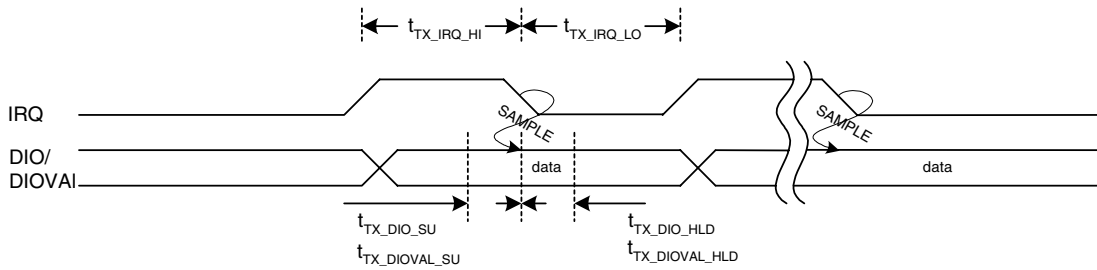


Figure 12. DIO Transmit Timing Diagram



Radio Parameters

Parameter Description	Conditions	Min.	Typ.	Max.	Unit
RF frequency range	(1)	2.400		2.483	GHz
Radio Receiver ($V_{CC} = 3.3\text{ V}$, $f_{osc} = 13.000\text{ MHz}$, X13OUT off, 64 chips/bit, Threshold Low = 8, Threshold High = 56, BER < 10-3)					
Sensitivity		-85	-95		dBm
Maximum received signal		-20	-6		dBm
RSSI value for PWRin > -40 dBm			28 - 31		
RSSI value for PWRin < -95 dBm			0 - 10		
Interference Performance					
Co-channel interference rejection Carrier-to-Interference (C/I)	C = -60 dBm		9		dB
Adjacent (1 MHz) channel selectivity C/I 1 MHz	C = -60 dBm		-2		dB
Adjacent (2 MHz) channel selectivity C/I 2 MHz	C = -60 dBm		-32		dB
Adjacent (> 3 MHz) channel selectivity C/I > 3 MHz	C = -67 dBm		-40		dB
Image ⁽²⁾ frequency interference, C/I image	C = -67 dBm		-31		dB
Adjacent (1 MHz) interference to in-band image frequency, C/I image $\pm 1\text{ MHz}$	C = -67 dBm		-38		dB
Out-of-band Blocking Interference Signal Frequency					
30 MHz to 2399 MHz except (FO/N and FO/N $\pm 1\text{ MHz}$) ⁽³⁾	C = -67 dBm		-24		dBm
2498 MHz to 12.75 GHz, except (FO/N and FO $\times N \pm 1\text{ MHz}$) ⁽³⁾	C = -67 dBm		-22		dBm
Intermodulation	C = -64 dBm $\Delta f = 5, 10\text{ MHz}$		-31		dBm
Spurious Emission					
30 MHz to 1 GHz				-57	dBm
1 GHz to 12.75 GHz except (4.8 GHz to 5.0 GHz)				-47	dBm
4.8 GHz to 5.0 GHz				-37 ⁽⁴⁾	dBm
Radio Transmitter ($V_{CC} = 3.3\text{ V}$, $f_{osc} = 13.000\text{ MHz}$)					
Maximum RF transmit power	PA = 7		-0.5		dBm
RF power control range			28.9		dB

- Notes:
1. Subject to regulation.
 2. Image frequency is +4 MHz from desired channel (2 MHz low IF, high side injection).
 3. FO = Tuned Frequency, N = Integer.
 4. Antenna matching network and antenna will attenuate the output signal at these frequencies to meet regulatory requirements.

Radio Parameters (Continued)

Parameter Description	Conditions	Min.	Typ.	Max.	Unit
RF power range control step size	Seven steps, monotonic		4.1		dB
Frequency deviation	PN code pattern 10101010		276		kHz
Frequency deviation	PN code pattern 11110000		317		kHz
Zero crossing eError			±80		ns
Occupied bandwidth	100-kHz resolution bandwidth, -6 dBc	500	898		kHz
Initial frequency offset			±44.6		kHz
In-band Spurious					
Second channel power (±2 MHz)			-41	-30	dBm
≥ Third channel power (>3 MHz)			-49	-40	dBm
Non-Harmonically Related Spurs					
30 MHz to 12.75 GHz				-57	dBm
Harmonic Spurs					
Second harmonic				-20	dBm
Third harmonic				-30	dBm
Fourth and greater harmonics				-47	dBm

- Notes:
1. Subject to regulation.
 2. Image frequency is +4 MHz from desired channel (2 MHz low IF, high side injection).
 3. FO = Tuned Frequency, N = Integer.
 4. Antenna matching network and antenna will attenuate the output signal at these frequencies to meet regulatory requirements.

Power Management Timing

Parameter	Description	Conditions	Min.	Typ	Max.	Unit
t_{PDN_X13}	Time from \overline{PD} deassert to X13OUT			2000		μs
t_{SPL_RDY}	Time from oscillator stable to start of SPI transactions		1			μs
t_{PWR_RST}	Power On to \overline{RESET} deasserted	V_{CC} at 2.7 V	1300			μs
t_{RST}	Minimum \overline{RESET} asserted pulse width		1			μs
t_{PWR_PD}	Power on to \overline{PD} deasserted ⁽¹⁾		1300			μs
t_{WAKE}	\overline{PD} deassert to clocks running ⁽²⁾			2000		μs
t_{PD}	Minimum \overline{PD} asserted pulse width		10			μs
t_{SLEEP}	\overline{PD} assert to low power mode			50		μs
t_{WAKE_INT}	\overline{PD} deassert to IRQ ⁽³⁾ assert (wake interrupt) ⁽⁴⁾			2000		μs
t_{STABLE}	\overline{PD} deassert to clock stable	to within ±10 ppm		2100		μs

- Notes:
1. The \overline{PD} pin must be asserted at power up to ensure proper crystal start-up.
 2. When X13OUT is enabled.
 3. Both the polarity and the drive method of the IRQ pin are programmable. See page 14 for more details. Figure 14 illustrates default values for the Configuration register (Reg 0x05, bits 1:0).
 4. A wake-up event is triggered when the \overline{PD} pin is deasserted. Figure 14 illustrates a wake-up event configured to trigger an IRQ pin event via the Wake Enable register (Reg 0x1C, bit 0 = 1).

Figure 13. Power On Reset/Reset Timing

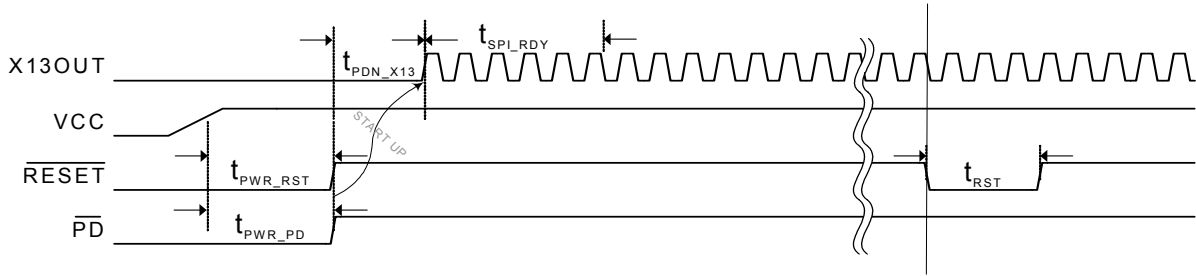
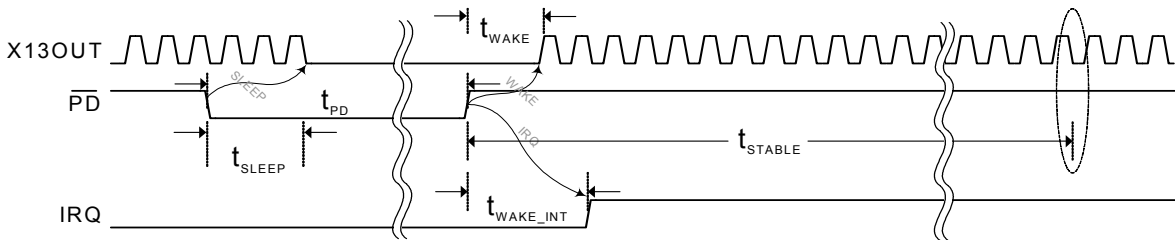


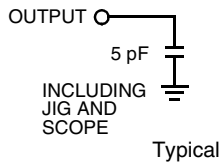
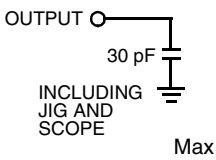
Figure 14. Sleep/Wake Timing



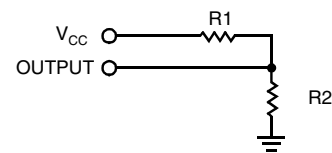
AC Test Loads and Waveforms for Digital Pins

Figure 15. AC Test Loads and Waveforms for Digital Pins

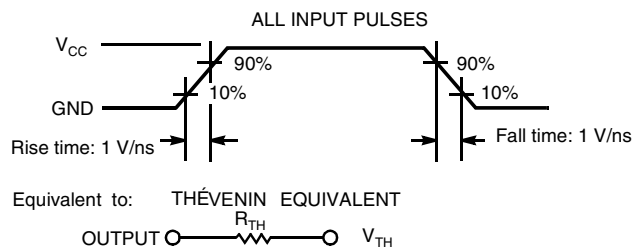
AC Test Loads



DC Test Load



Parameter		Unit
R1	1071	Ω
R2	937	Ω
R _{TH}	500	Ω
V _{TH}	1.4	V
V _{CC}	3.00	V

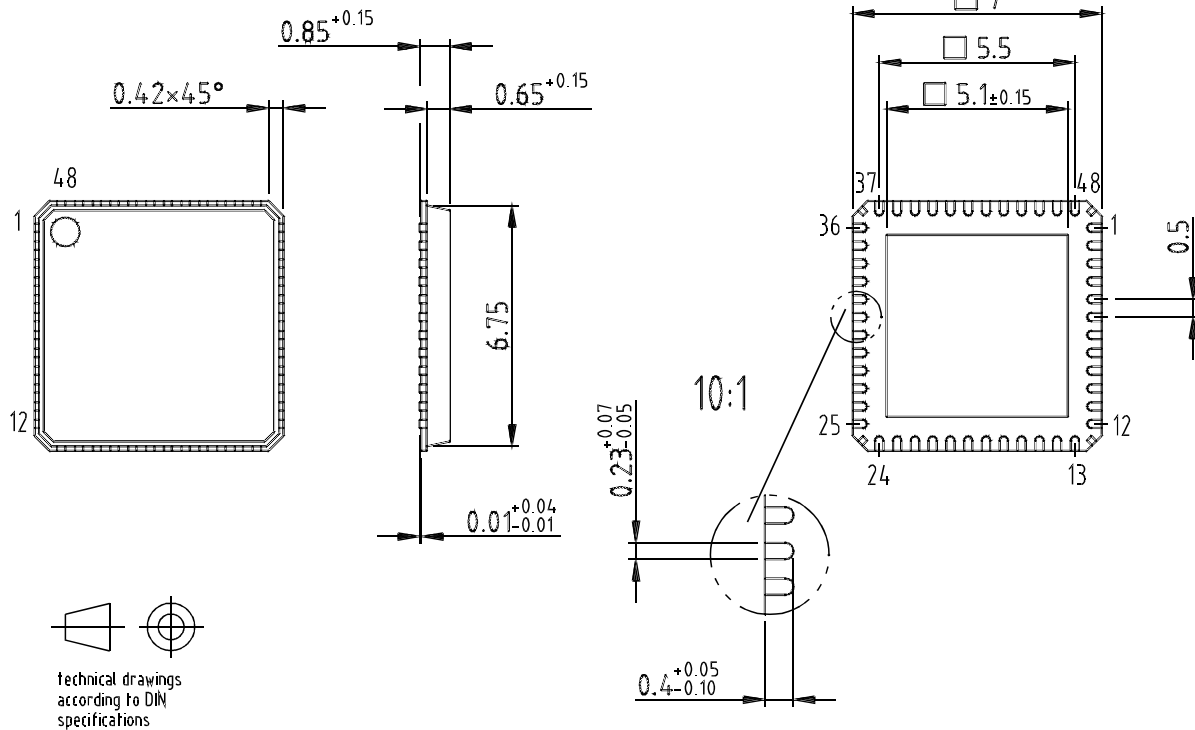


Ordering Information

Extended Type Number	Package	Remarks
ATR2434-PLT	QFN48 - 7x7	Tray
ATR2434-PLT	QFN48 - 7x7	Samples

Package Information

Package: QFN 48 - 7x7
 Exposed pad 5.1x5.1
 (acc. JEDEC OUTLINE No. MO-220)
 Dimensions in mm



Drawing-No.: 6.543-5068.01-4
 Issue: 3; 24.01.03



Atmel Corporation

2325 Orchard Parkway
San Jose, CA 95131, USA
Tel: 1(408) 441-0311
Fax: 1(408) 487-2600

Regional Headquarters

Europe

Atmel Sarl
Route des Arsenaux 41
Case Postale 80
CH-1705 Fribourg
Switzerland
Tel: (41) 26-426-5555
Fax: (41) 26-426-5500

Asia

Room 1219
Chinachem Golden Plaza
77 Mody Road Tsimshatsui
East Kowloon
Hong Kong
Tel: (852) 2721-9778
Fax: (852) 2722-1369

Japan

9F, Tonetsu Shinkawa Bldg.
1-24-8 Shinkawa
Chuo-ku, Tokyo 104-0033
Japan
Tel: (81) 3-3523-3551
Fax: (81) 3-3523-7581

Atmel Operations

Memory

2325 Orchard Parkway
San Jose, CA 95131, USA
Tel: 1(408) 441-0311
Fax: 1(408) 436-4314

Microcontrollers

2325 Orchard Parkway
San Jose, CA 95131, USA
Tel: 1(408) 441-0311
Fax: 1(408) 436-4314

La Chantrierie
BP 70602
44306 Nantes Cedex 3, France
Tel: (33) 2-40-18-18-18
Fax: (33) 2-40-18-19-60

ASIC/ASSP/Smart Cards

Zone Industrielle
13106 Rousset Cedex, France
Tel: (33) 4-42-53-60-00
Fax: (33) 4-42-53-60-01

1150 East Cheyenne Mtn. Blvd.
Colorado Springs, CO 80906, USA
Tel: 1(719) 576-3300
Fax: 1(719) 540-1759

Scottish Enterprise Technology Park
Maxwell Building
East Kilbride G75 0QR, Scotland
Tel: (44) 1355-803-000
Fax: (44) 1355-242-743

RF/Automotive

Theresienstrasse 2
Postfach 3535
74025 Heilbronn, Germany
Tel: (49) 71-31-67-0
Fax: (49) 71-31-67-2340

1150 East Cheyenne Mtn. Blvd.
Colorado Springs, CO 80906, USA
Tel: 1(719) 576-3300
Fax: 1(719) 540-1759

Biometrics/Imaging/Hi-Rel MPU/ High Speed Converters/RF Datacom

Avenue de Rochepleine
BP 123
38521 Saint-Egreve Cedex, France
Tel: (33) 4-76-58-30-00
Fax: (33) 4-76-58-34-80

Literature Requests

www.atmel.com/literature

Disclaimer: Atmel Corporation makes no warranty for the use of its products, other than those expressly contained in the Company's standard warranty which is detailed in Atmel's Terms and Conditions located on the Company's web site. The Company assumes no responsibility for any errors which may appear in this document, reserves the right to change devices or specifications detailed herein at any time without notice, and does not make any commitment to update the information contained herein. No licenses to patents or other intellectual property of Atmel are granted by the Company in connection with the sale of Atmel products, expressly or by implication. Atmel's products are not authorized for use as critical components in life support devices or systems.

© Atmel Corporation 2004. All rights reserved.

Atmel® and combinations thereof are the registered trademarks of Atmel Corporation or its subsidiaries.

WirelessUSB™ is a trademark of CYPRESS Semiconductor Corporation. Other terms and product names may be the trademarks of others.



Printed on recycled paper.

4822C-ISM-09/04