

# LMV841 / LMV844

## CMOS Input, RRIO, Wide Supply Range Operational Amplifiers

### General Description

The LMV841 and LMV844 are low-voltage and low-power operational amplifiers that operate with supply voltages ranging from 2.7V to 12V and have rail-to-rail input and output capability.

The LMV841 and LMV844 are low offset voltage and low supply current amplifiers with MOS inputs, characteristics that make the LMV841/LMV844 ideal for sensor interface and battery powered applications.

The LMV841 is offered in the space saving 5-pin SC70 package and the quad LMV844 comes in the 14-Pin TSSOP package. These small packages are solutions for area constrained PC boards and portable electronics.

### Features

Unless otherwise noted, typical values at  $T_A = 25^\circ\text{C}$ ,  $V^+ = 5\text{V}$

- Space saving 5-Pin SC70 package
- Supply voltage range 2.7V to 12V
- Guaranteed at 3.3V, 5V and  $\pm 5\text{V}$
- Low supply current 1 mA per channel
- Unity gain bandwidth 4.5 MHz
- Open loop gain 100 dB
- Input offset voltage 500  $\mu\text{V}$  max
- Input bias current 0.3 pA
- CMRR 100 dB
- Input voltage noise 20  $\text{nV}/\sqrt{\text{Hz}}$
- Temperature range  $-40^\circ\text{C}$  to  $125^\circ\text{C}$
- Rail-to-rail input
- Rail-to-rail output

### Applications

- High impedance sensor interface
- Battery powered instrumentation
- High gain amplifiers
- DAC buffer
- Instrumentation amplifiers
- Active Filters

### Typical Applications

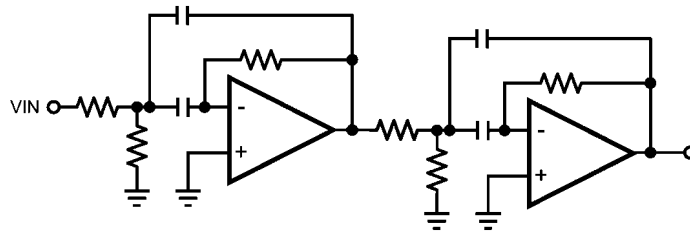

Active Band-pass Filter

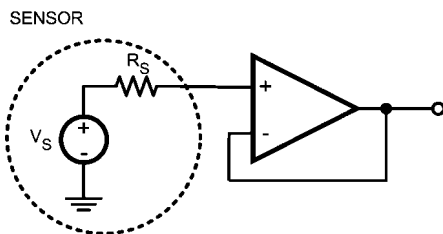

High Impedance Sensor Interface  
CMOS input Feature

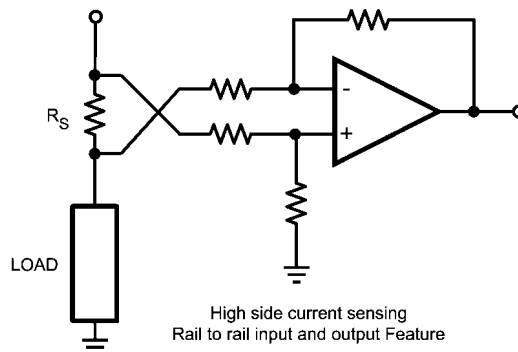

High side current sensing  
Rail to rail input and output Feature

20168301

**Absolute Maximum Ratings** (Note 1)

If Military/Aerospace specified devices are required, please contact the National Semiconductor Sales Office/ Distributors for availability and specifications.

ESD Tolerance (Note 2)	
Human Body Model	2 kV
Machine Model	200V
$V_{IN}$ Differential	$\pm 300$ mV
Supply Voltage ( $V^+ - V^-$ )	13.2V
Voltage at Input/Output Pins	$V^+ + 0.3V, V^- - 0.3V$
Input Current	10 mA
Storage Temperature Range	$-65^\circ\text{C}$ to $+150^\circ\text{C}$

Junction Temperature (Note 3)	$+150^\circ\text{C}$
Soldering Information	
Infrared or Convection (20 sec)	$235^\circ\text{C}$
Wave Soldering Lead Temp. (10 sec)	$260^\circ\text{C}$

**Operating Ratings** (Note 1)

Temperature Range (Note 3)	$-40^\circ\text{C}$ to $+125^\circ\text{C}$
Supply Voltage ( $V^+ - V^-$ )	2.7V to 12V
Package Thermal Resistance ( $\theta_{JA}$ (Note 3))	
5-Pin SC70	$334^\circ\text{C}/\text{W}$
14-Pin TSSOP	$110^\circ\text{C}/\text{W}$

**3.3V Electrical Characteristics** (Note 4)

Unless otherwise specified, all limits are guaranteed for at  $T_A = 25^\circ\text{C}$ ,  $V^+ = 3.3V$ ,  $V^- = 0V$ ,  $V_{CM} = V^+/2$ , and  $R_L > 10\text{ M}\Omega$  to  $V^+/2$ .

**Boldface** limits apply at the temperature extremes.

Symbol	Parameter	Conditions	Min (Note 6)	Typ (Note 5)	Max (Note 6)	Units
$V_{OS}$	Input Offset Voltage			8	$\pm 500$ <b><math>\pm 800</math></b>	$\mu\text{V}$
$TCV_{OS}$	Input Offset Voltage Drift (Note 7)			0.5	<b><math>\pm 5</math></b>	$\mu\text{V}/^\circ\text{C}$
$I_B$	Input Bias Current (Notes 7, 8)			0.3	10 <b>300</b>	pA
$I_{OS}$	Input Offset Current			40		fA
CMRR	Common Mode Rejection Ratio LMV841	$0V \leq V_{CM} \leq 3.3V$	84	100		dB
	Common Mode Rejection Ratio LMV844		<b>77</b>	100		
PSRR	Power Supply Rejection Ratio	$2.7V \leq V^+ \leq 12V, V_O = V^+/2$	86 <b>82</b>	100		dB
CMVR	Input Common-Mode Voltage Range	CMRR $\geq 50$ dB	<b>-0.1</b>		<b>3.4</b>	V
$A_{VOL}$	Large Signal Voltage Gain	$R_L = 2\text{ k}\Omega$ $V_O = 0.3V$ to $3.0V$	100 <b>96</b>	118		dB
		$R_L = 10\text{ k}\Omega$ $V_O = 0.2V$ to $3.1V$	100 <b>96</b>	129		
$V_O$	Output Swing High, measured from $V^+$	$R_L = 2\text{ k}\Omega$ to $V^+/2$		60	80 <b>120</b>	mV
		$R_L = 10\text{ k}\Omega$ to $V^+/2$		32	50 <b>70</b>	
	Output Swing Low, measured from $V^-$	$R_L = 2\text{ k}\Omega$ to $V^+/2$		70	100 <b>120</b>	mV
		$R_L = 10\text{ k}\Omega$ to $V^+/2$		35	65 <b>75</b>	
$I_O$	Output Short Circuit Current (Notes 3, 9)	Sourcing $V_O = V^+/2$ $V_{IN} = 100\text{ mV}$	20 <b>15</b>	30		mA
		Sinking $V_O = V^+/2$ $V_{IN} = -100\text{ mV}$	20 <b>15</b>	30		
$I_S$	Supply Current	Per Channel		0.98	1.5 <b>2</b>	mA
SR	Slew Rate (Note 10)	$A_V = +1, V_O = 2.3 V_{PP}$ 10% to 90%		2.5		V/ $\mu\text{s}$
GBW	Gain Bandwidth Product			4.5		MHz
$\Phi_m$	Phase Margin			67		Deg

Symbol	Parameter	Conditions	Min (Note 6)	Typ (Note 5)	Max (Note 6)	Units
$e_n$	Input-Referred Voltage Noise	$f = 1 \text{ kHz}$		20		$\text{nV}/\sqrt{\text{Hz}}$
$R_{\text{OUT}}$	Open Loop Output Impedance	$f = 3 \text{ MHz}$		70		$\Omega$
THD+N	Total Harmonic Distortion + Noise	$f = 1 \text{ kHz}$ , $A_V = 1$ $R_L = 10 \text{ k}\Omega$		0.005		%
$C_{\text{IN}}$	Input Capacitance			13		pF

## 5V Electrical Characteristics (Note 4)

Unless otherwise specified, all limits are guaranteed for at  $T_A = 25^\circ\text{C}$ ,  $V^+ = 5\text{V}$ ,  $V^- = 0\text{V}$ ,  $V_{\text{CM}} = V^+/2$ , and  $R_L > 10 \text{ M}\Omega$  to  $V^+/2$ .

**Boldface** limits apply at the temperature extremes.

Symbol	Parameter	Conditions	Min (Note 6)	Typ (Note 5)	Max (Note 6)	Units
$V_{\text{OS}}$	Input Offset Voltage			-5	$\pm 500$ <b><math>\pm 800</math></b>	$\mu\text{V}$
$\text{TCV}_{\text{OS}}$	Input Offset Voltage Drift (Note 7)			0.35	<b><math>\pm 5</math></b>	$\mu\text{V}/^\circ\text{C}$
$I_B$	Input Bias Current (Notes 7, 8)			0.3	10 <b>300</b>	pA
$I_{\text{OS}}$	Input Offset Current			40		fA
CMRR	Common Mode Rejection Ratio LMV841	$0\text{V} \leq V_{\text{CM}} \leq 5\text{V}$	86 <b>80</b>	100		dB
	Common Mode Rejection Ratio LMV844		81 <b>79</b>	100		
PSRR	Power Supply Rejection Ratio	$2.7\text{V} \leq V^+ \leq 12\text{V}$ , $V_O = V^+/2$	86 <b>82</b>	100		dB
CMVR	Input Common-Mode Voltage Range	CMRR $\geq 50 \text{ dB}$	<b>-0.2</b>		<b>5.2</b>	V
$A_{\text{VOL}}$	Large Signal Voltage Gain	$R_L = 2 \text{ k}\Omega$ $V_O = 0.3\text{V to } 4.7\text{V}$	100 <b>96</b>	118		dB
		$R_L = 10 \text{ k}\Omega$ $V_O = 0.2\text{V to } 4.8\text{V}$	100 <b>96</b>	129		
$V_O$	Output Swing High, measured from $V^+$	$R_L = 2 \text{ k}\Omega$ to $V^+/2$		70	100 <b>120</b>	mV
		$R_L = 10 \text{ k}\Omega$ to $V^+/2$		40	50 <b>70</b>	
$V_O$	Output Swing Low, measured from $V^-$	$R_L = 2 \text{ k}\Omega$ to $V^+/2$		82	120 <b>140</b>	mV
		$R_L = 10 \text{ k}\Omega$ to $V^+/2$		41	70 <b>80</b>	
$I_O$	Output Short Circuit Current (Notes 3, 9)	Sourcing $V_O = V^+/2$ $V_{\text{IN}} = 100 \text{ mV}$	20 <b>15</b>	30		mA
		Sinking $V_O = V^+/2$ $V_{\text{IN}} = -100 \text{ mV}$	20 <b>15</b>	30		
$I_S$	Supply Current	Per Channel		1.02	1.5 <b>2</b>	mA
SR	Slew Rate (Note 10)	$A_V = +1$ , $V_O = 4 V_{\text{PP}}$ 10% to 90%		2.5		$\text{V}/\mu\text{s}$
GBW	Gain Bandwidth Product			4.5		MHz
$\Phi_m$	Phase Margin			67		Deg
$e_n$	Input-Referred Voltage Noise	$f = 1 \text{ kHz}$		20		$\text{nV}/\sqrt{\text{Hz}}$
$R_{\text{OUT}}$	Open Loop Output Impedance	$f = 3 \text{ MHz}$		70		$\Omega$

Symbol	Parameter	Conditions	Min (Note 6)	Typ (Note 5)	Max (Note 6)	Units
THD+N	Total Harmonic Distortion + Noise	$f = 1 \text{ kHz}$ , $A_V = 1$ $R_L = 10 \text{ k}\Omega$		0.003		%
$C_{IN}$	Input Capacitance			13		pF
<b>±5V Electrical Characteristics</b> (Note 4)						
Unless otherwise specified, all limits are guaranteed for at $T_A = 25^\circ\text{C}$ , $V^+ = 5\text{V}$ , $V^- = -5\text{V}$ , $V_{CM} = 0\text{V}$ , and $R_L > 10 \text{ M}\Omega$ to $V_{CM}$ .						
<b>Boldface</b> limits apply at the temperature extremes.						
Symbol	Parameter	Conditions	Min (Note 6)	Typ (Note 5)	Max (Note 6)	Units
$V_{OS}$	Input Offset Voltage			-17	$\pm 500$ <b><math>\pm 800</math></b>	$\mu\text{V}$
$TCV_{OS}$	Input Offset Voltage Drift (Note 7)			0.25	<b><math>\pm 5</math></b>	$\mu\text{V}/^\circ\text{C}$
$I_B$	Input Bias Current (Notes 7, 8)			0.3	10 <b>300</b>	pA
$I_{OS}$	Input Offset Current			40		fA
CMRR	Common Mode Rejection Ratio LMV841	$-5\text{V} \leq V_{CM} \leq 5\text{V}$	86	100		dB
	Common Mode Rejection Ratio LMV844		<b>80</b>	100		
PSRR	Power Supply Rejection Ratio	$2.7\text{V} \leq V^+ \leq 12\text{V}$ , $V_O = 0\text{V}$	86 <b>82</b>	100		dB
CMVR	Input Common-Mode Voltage Range	CMRR $\geq 50 \text{ dB}$	<b>-5.2</b>		<b>5.2</b>	V
$A_{VOL}$	Large Signal Voltage Gain	$R_L = 2 \text{ k}\Omega$ $V_O = -4.7\text{V to } 4.7\text{V}$	100 <b>96</b>	118		dB
		$R_L = 10 \text{ k}\Omega$ $V_O = -4.8\text{V to } 4.8\text{V}$	100 <b>96</b>	129		
$V_O$	Output Swing High, measured from $V^+$	$R_L = 2 \text{ k}\Omega$ to $0\text{V}$		105	130 <b>155</b>	mV
		$R_L = 10 \text{ k}\Omega$ to $0\text{V}$		50	75 <b>95</b>	
	Output Swing Low, measured from $V^-$	$R_L = 2 \text{ k}\Omega$ to $0\text{V}$		115	160 <b>200</b>	mV
$R_L = 10 \text{ k}\Omega$ to $0\text{V}$		53	80 <b>100</b>			
$I_O$	Output Short Circuit Current (Notes 3, 9)	Sourcing $V_O = 0\text{V}$ $V_{IN} = 100 \text{ mV}$	20 <b>15</b>	30		mA
		Sinking $V_O = 0\text{V}$ $V_{IN} = -100 \text{ mV}$	20 <b>15</b>	30		
$I_S$	Supply Current	Per Channel		1.11	1.7 <b>2</b>	mA
SR	Slew Rate (Note 10)	$A_V = +1$ , $V_O = 9 V_{PP}$ 10% to 90%		2.5		V/ $\mu\text{s}$
GBW	Gain Bandwidth Product			4.5		MHz
$\Phi_m$	Phase Margin			67		Deg
$e_n$	Input-Referred Voltage Noise	$f = 1 \text{ kHz}$		20		$\text{nV}/\sqrt{\text{Hz}}$
$R_{OUT}$	Open Loop Output Impedance	$f = 3 \text{ MHz}$		70		$\Omega$
THD+N	Total Harmonic Distortion + Noise	$f = 1 \text{ kHz}$ , $A_V = 1$ $R_L = 10 \text{ k}\Omega$		0.006		%
$C_{IN}$	Input Capacitance			13		pF

**Note 1:** Absolute Maximum Ratings indicate limits beyond which damage to the device may occur. Operating Ratings indicate conditions for which the device is intended to be functional, but specific performance is not guaranteed. For guaranteed specifications and the test conditions, see the Electrical Characteristics Tables.

**Note 2:** Human Body Model, applicable std. MIL-STD-883, Method 3015.7. Machine Model, applicable std. JESD22-A115-A (ESD MM std. of JEDEC) Field-Induced Charge-Device Model, applicable std. JESD22-C101-C (ESD FICDM std. of JEDEC).

**Note 3:** The maximum power dissipation is a function of  $T_{J(MAX)}$ ,  $\theta_{JA}$ , and  $T_A$ . The maximum allowable power dissipation at any ambient temperature is  $P_D = (T_{J(MAX)} - T_A) / \theta_{JA}$ . All numbers apply for packages soldered directly onto a PC board.

**Note 4:** Electrical table values apply only for factory testing conditions at the temperature indicated. Factory testing conditions result in very limited self-heating of the device.

**Note 5:** Typical values represent the most likely parametric norm as determined at the time of characterization. Actual typical values may vary over time and will also depend on the application and configuration. The typical values are not tested and are not guaranteed on shipped production material.

**Note 6:** Limits are 100% production tested at 25°C. Limits over the operating temperature range are guaranteed through correlations using statistical quality control (SQC) method.

**Note 7:** This parameter is guaranteed by design and/or characterization and is not tested in production.

**Note 8:** Positive current corresponds to current flowing into the device.

**Note 9:** Short circuit test is a momentary test.

**Note 10:** Number specified is the slower of positive and negative slew rates.

## Connection Diagrams

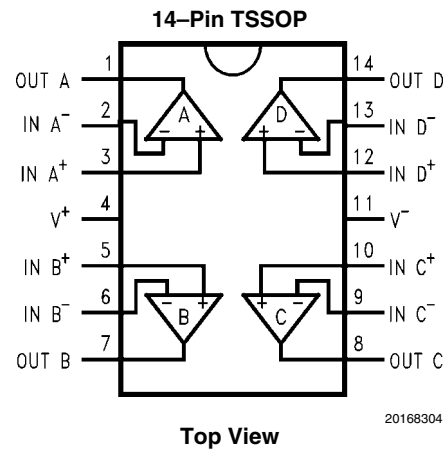
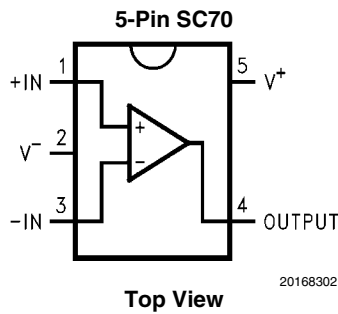

## Ordering Information

Package	Part Number	Package Marking	Transport Media	NSC Drawing
5-Pin SC70	LMV841MG	A97	1k Units Tape and Reel	MAA05A
	LMV841MGX		3k Units Tape and Reel	
14-Pin TSSOP	LMV844MT	LMV844MT	94 Units/Rail	MTC14
	LMV844MTX		2.5k Units Tape and Reel	

**Typical Performance Characteristics** At  $T_A = 25^\circ\text{C}$ ,  $R_L = 10\text{ k}\Omega$ ,  $V_S = 5\text{V}$ . Unless otherwise specified.

**$V_{OS}$  vs.  $V_{CM}$  Over Temperature at 3.3V**

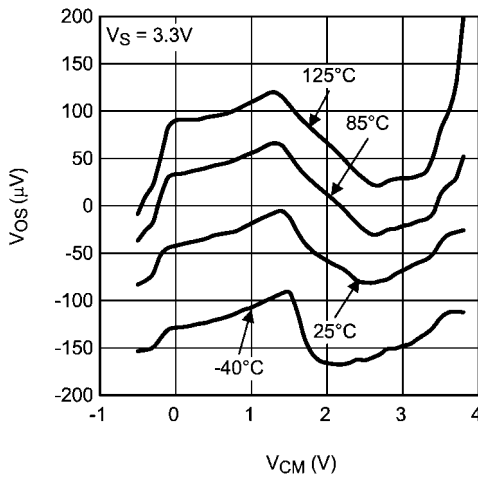

20168310

**$V_{OS}$  vs.  $V_{CM}$  Over Temperature at 5.0V**

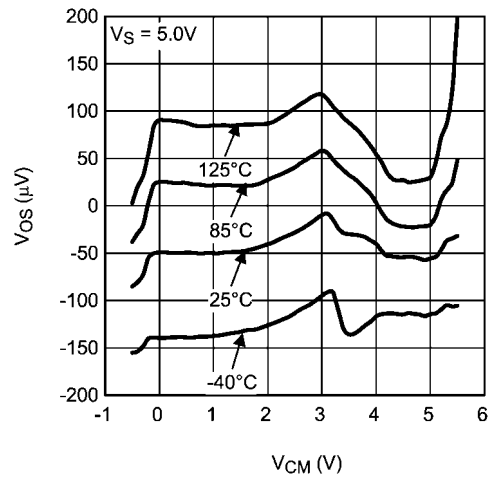

20168311

**$V_{OS}$  vs.  $V_{CM}$  Over Temperature at  $\pm 5.0\text{V}$**

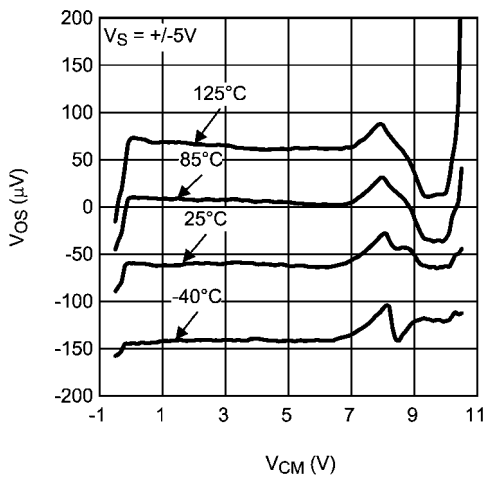

20168312

**$V_{OS}$  vs. Supply Voltage**

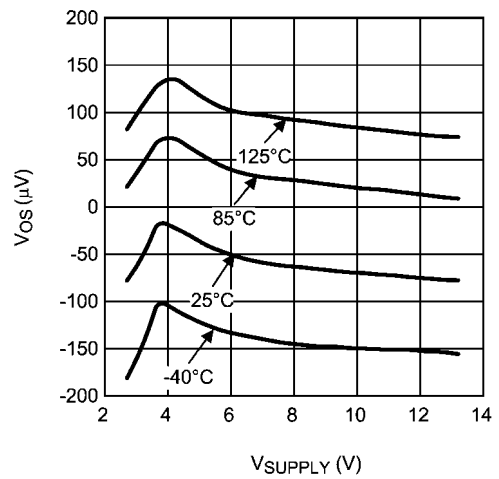

20168313

**$V_{OS}$  vs. Temperature**

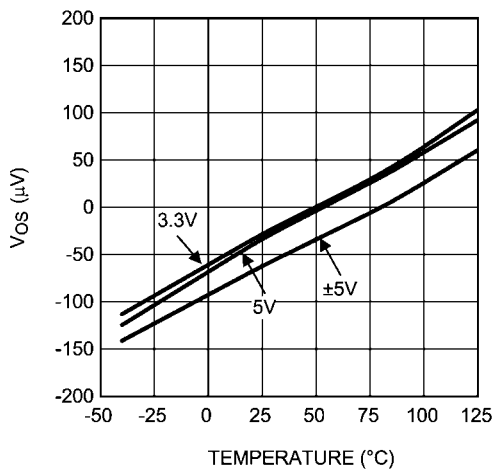

20168314

**DC Gain vs.  $V_{OUT}$**

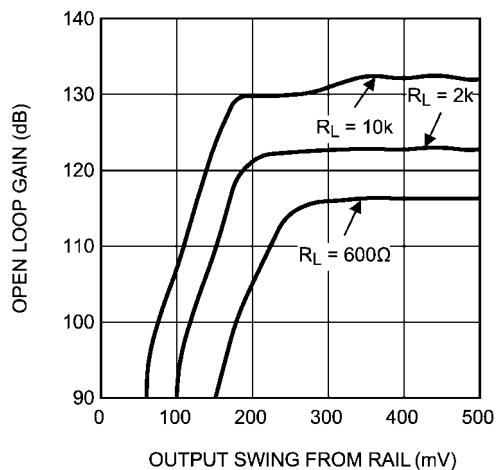

20168315

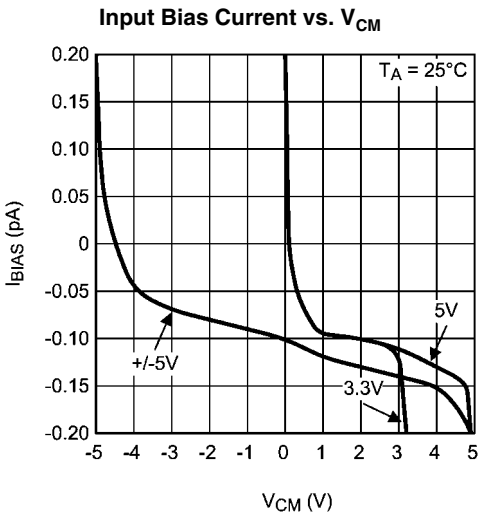

20168316

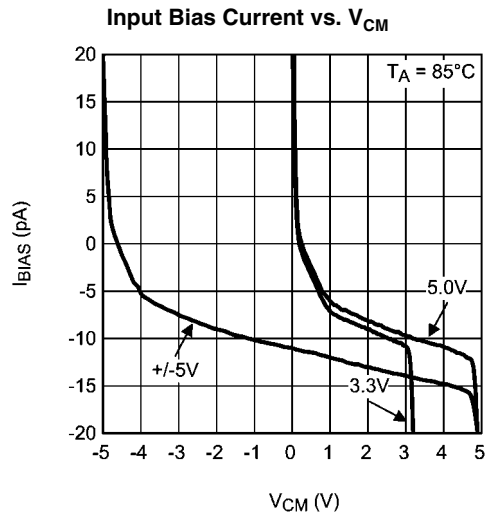

20168317

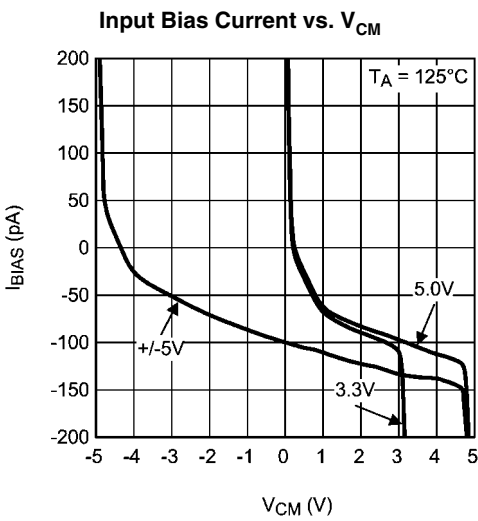

20168318

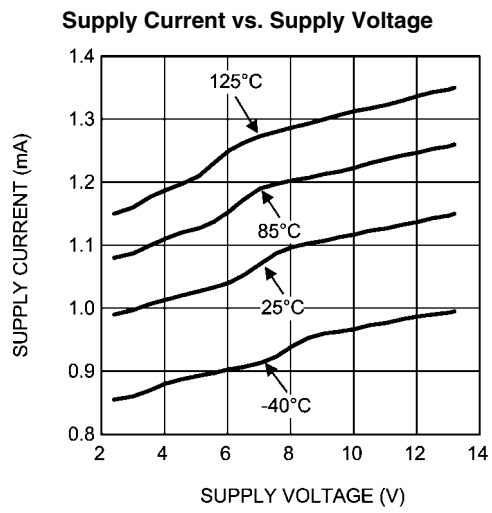

20168319

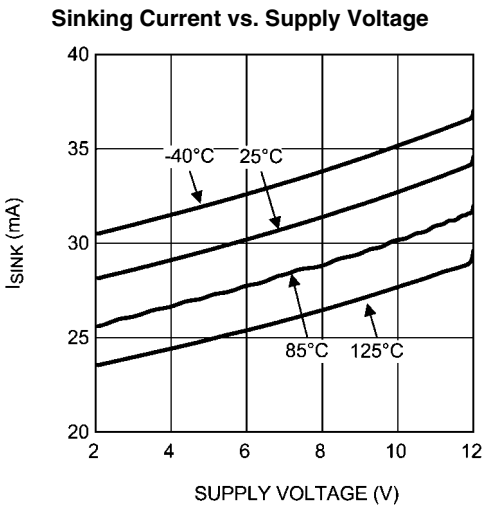

20168320

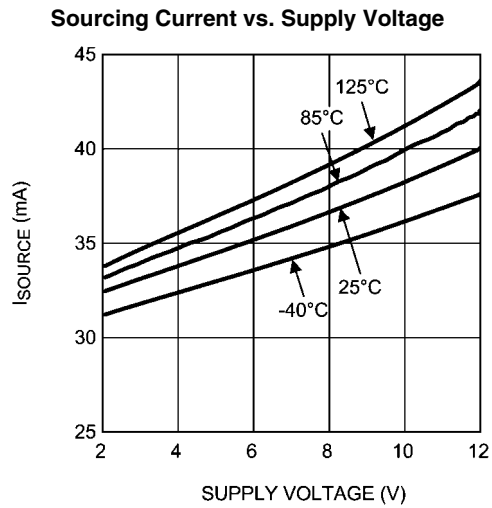

20168321

Output Swing High vs. Supply Voltage  $R_L = 2k$

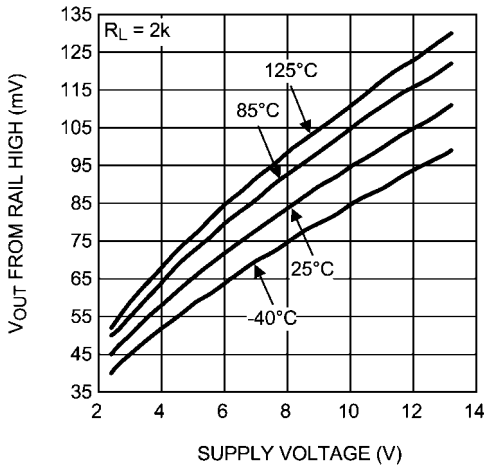

20168322

Output Swing High vs. Supply Voltage  $R_L = 10k$

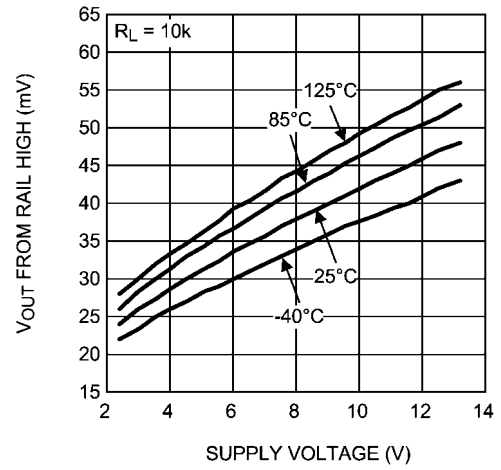

20168323

Output Swing Low vs. Supply Voltage  $R_L = 2k$

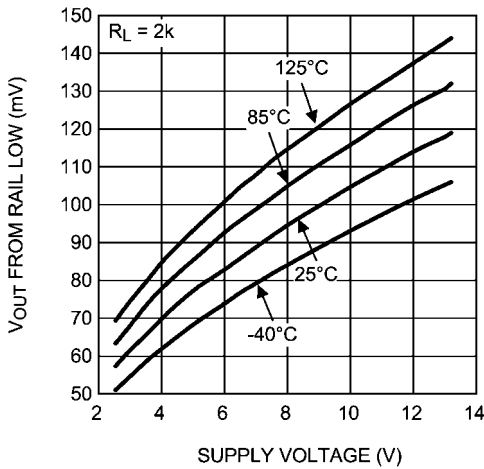

20168324

Output Swing Low vs. Supply Voltage  $R_L = 10k$

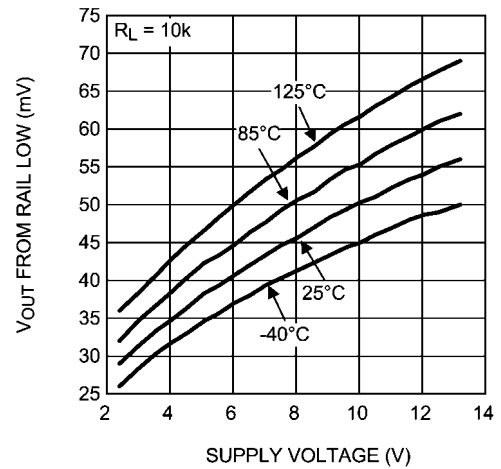

20168325

Output Voltage Swing vs. Load Current

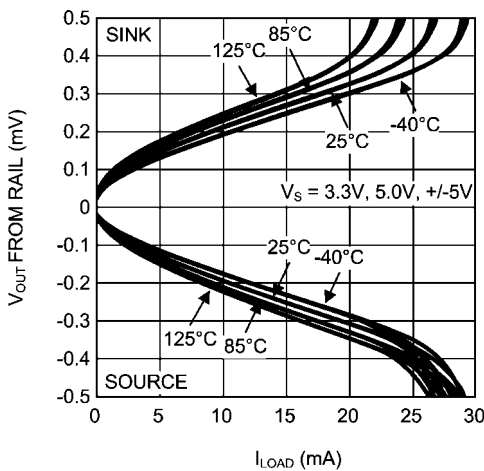

20168326

Open Loop Frequency Response Over Temperature

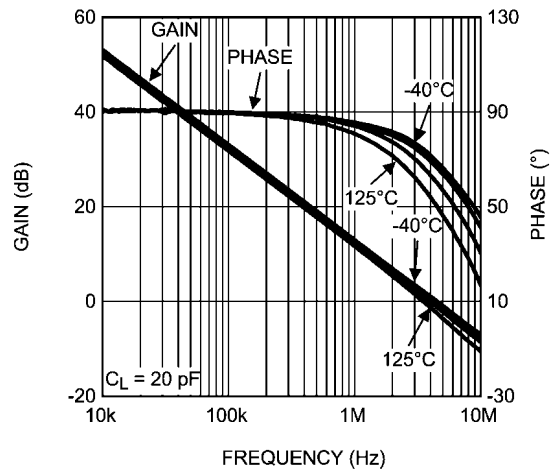

20168327



Open Loop Frequency Response Over Load Conditions

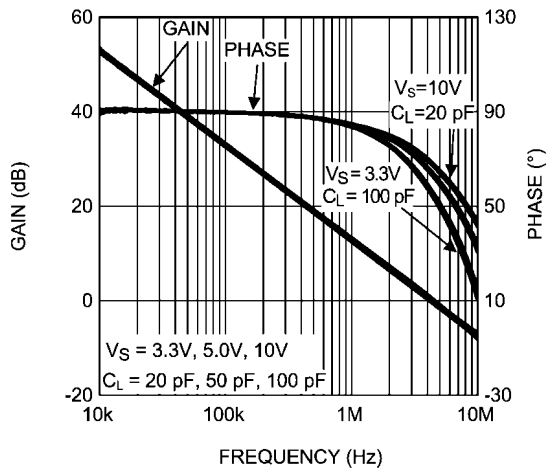

20168328

Phase Margin vs.  $C_L$

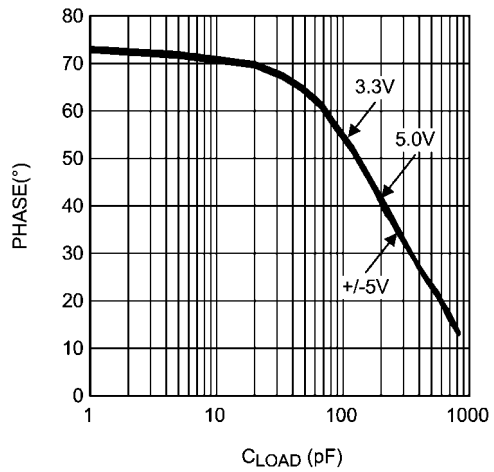

20168329

PSRR vs. Frequency

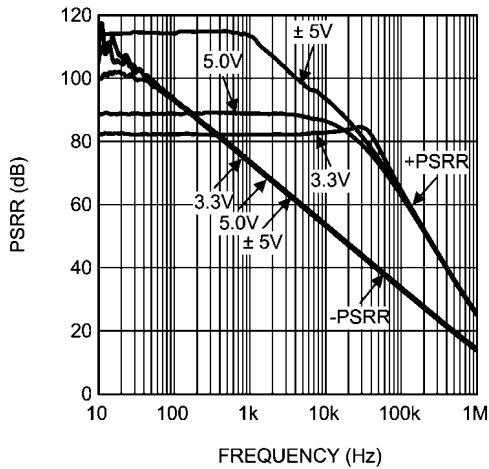

20168330

CMRR vs. Frequency

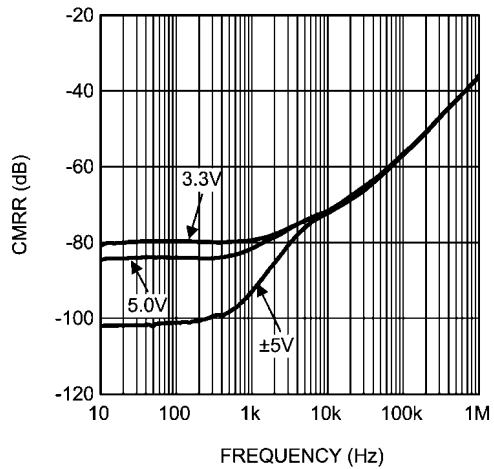

20168331

Channel separation vs. Frequency

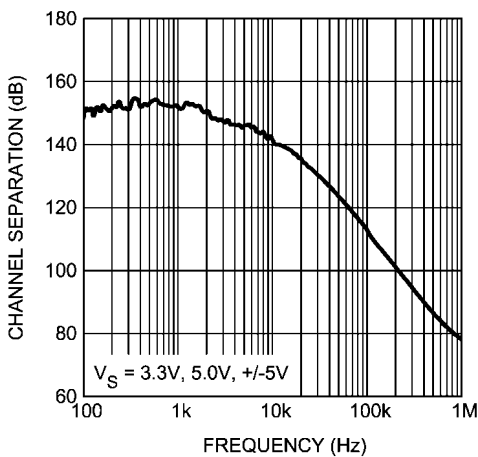

20168332

Large Signal Step Response With GAIN = 1

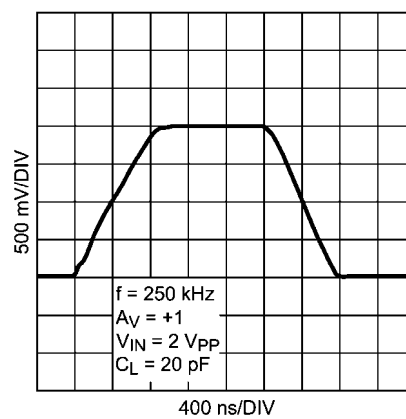

20168373

Large Signal Step Response With GAIN = 10

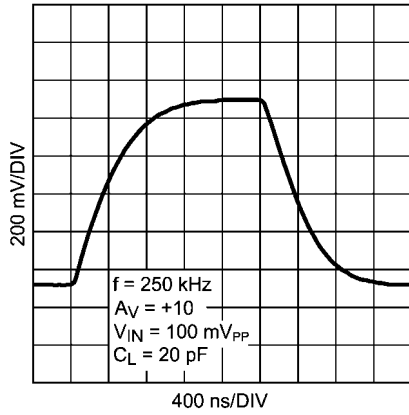

20168374

Small Signal Step Response With GAIN = 1

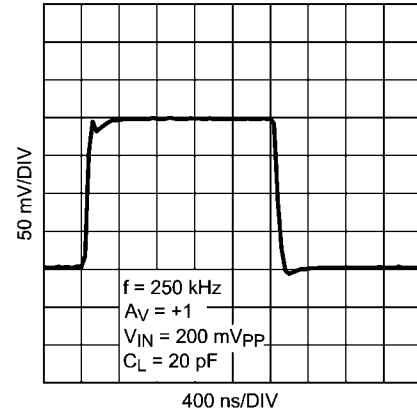

20168335

Small Signal Step Response With GAIN = 10

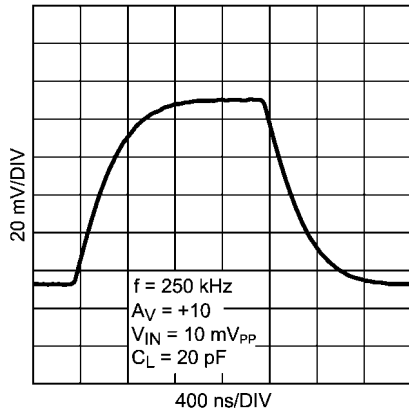

20168376

Overshoot vs  $C_L$

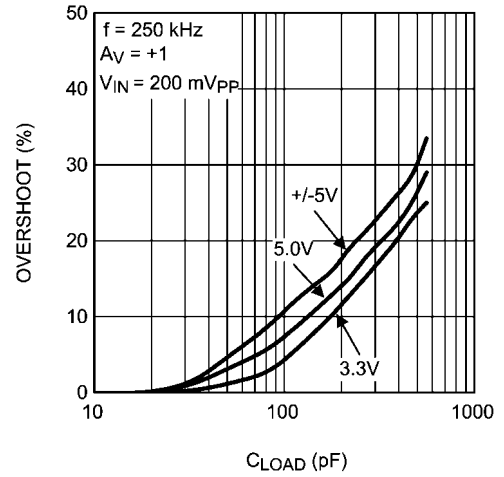

20168338

Input Voltage Noise vs. Frequency

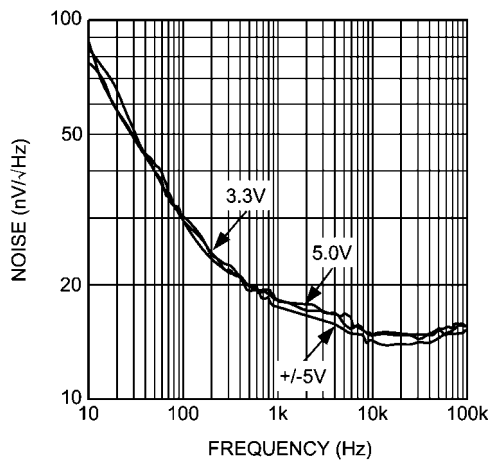

20168339

THD+N vs. Frequency

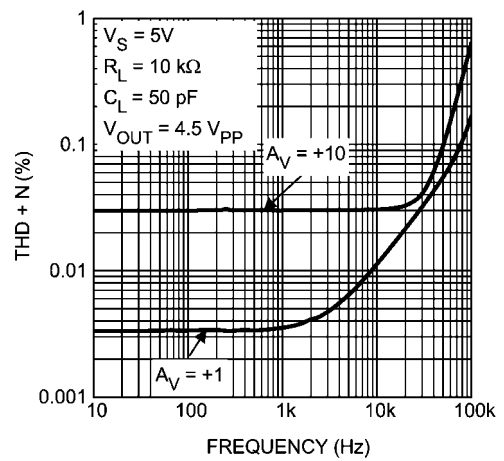

20168340

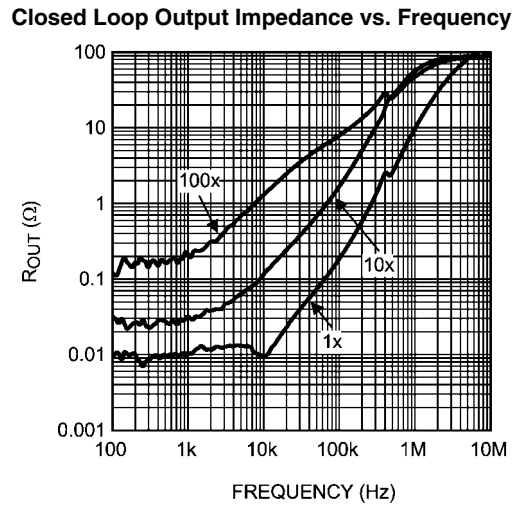
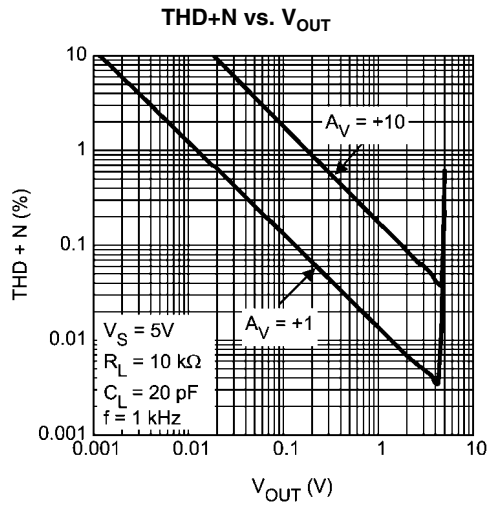

## Application Information

### INTRODUCTION

The LMV841 and LMV844 are operational amplifiers with near-precision specifications: low noise, low temperature drift, low offset and rail-to-rail input and output.

The low supply current, a temperature range of  $-40^{\circ}\text{C}$  to  $125^{\circ}\text{C}$ , the 12V supply with CMOS input and the small SC70 package make this a unique op amp family.

Possible applications are instrumentation, medical, test equipment, audio and automotive applications.

The small SC70 package for the LMV841, and the low supply current per amplifier, 1 mA, make the LMV841/LMV844 perfect choices for portable electronics.

### INPUT PROTECTION

The LMV841/LMV844 have a set of anti-parallel diodes  $D_1$  and  $D_2$  between the input pins, as shown in *Figure 1*. These diodes are present to protect the input stage of the amplifier. At the same time, they limit the amount of differential input voltage that is allowed on the input pins.

A differential signal larger than one diode voltage drop can damage the diodes. The differential signal between the inputs needs to be limited to  $\pm 300\text{ mV}$  or the input current needs to be limited to  $\pm 10\text{ mA}$ .

Note that when the op amp is slewing, a differential input voltage exists that forward biases the protection diodes. This may result in current being drawn from the signal source. While this current is already limited by the internal resistors  $R_1$  and  $R_2$  (both  $130\Omega$ ), a resistor of  $1\text{ k}\Omega$  can be placed in the feedback path, or a  $500\Omega$  resistor can be placed in series with the input signal for further limitation.

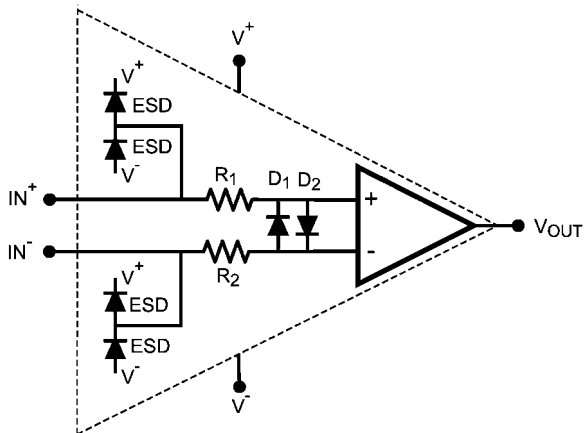

20168351

**FIGURE 1. Protection Diodes between the Input Pins**

### INPUT STAGE

The input stage of this amplifier consists of a PMOS and an NMOS input pair to achieve a more than rail-to-rail input range.

For input voltages close to the negative rail, only the PMOS pair is active. Close to the positive rail, only the NMOS pair is active.

For intermediate signals, the transition from PMOS pair to NMOS pair will result in a very small offset shift, which appears at approximately 1V from the positive rail.

To reduce this small offset shift, the amplifier is trimmed during production, resulting in an input offset voltage of less than  $0.5\text{ mV}$  at room temperature over the total input range.

### CAPACITIVE LOAD

The LMV841/LMV844 can be connected as non-inverting unity-gain amplifiers. This configuration is the most sensitive to capacitive loading.

The combination of a capacitive load placed on the output of an amplifier along with the amplifier's output impedance creates a phase lag, which reduces the phase margin of the amplifier. If the phase margin is significantly reduced, the response will be underdamped which causes peaking in the transfer and when there is too much peaking the op amp might start oscillating.

In order to drive heavier capacitive loads, an isolation resistor,  $R_{\text{ISO}}$ , should be used, as shown in *Figure 2*. By using this isolation resistor, the capacitive load is isolated from the amplifier's output, and hence, the pole caused by  $C_L$  is no longer in the feedback loop. The larger the value of  $R_{\text{ISO}}$ , the more stable the output voltage will be. If values of  $R_{\text{ISO}}$  are sufficiently large, the feedback loop will be stable, independent of the value of  $C_L$ . However, larger values of  $R_{\text{ISO}}$  result in reduced output swing and reduced output current drive.

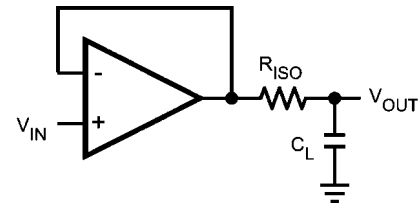

20168350

**FIGURE 2. Isolating Capacitive Load**

### REDUCING OVERSHOOT

When the output of the op amp is at its lower swing limit (i.e. saturated near  $V^-$ ), rapidly rising signals can cause some overshoot.

This overshoot can be reduced by adding a resistor from the output to  $V^+$ . Even in extreme situations at high temperatures, a  $10\text{ k}\Omega$  resistor is sufficient to reduce the overshoot to negligible levels.

The resistor at the output will however reduce the maximum output swing, as would any resistive load at the output.

### DECOUPLING AND LAYOUT

Care must be given when creating the board layout for the op amp.

For decoupling the supply lines it is suggested that  $10\text{ nF}$  capacitors be placed as close as possible to the op amp.

For single supply, place a capacitor between  $V^+$  and  $V^-$ . For dual supplies, place one capacitor between  $V^+$  and the board ground, and the second capacitor between ground and  $V^-$ .

### NOISE DUE TO RESISTORS

The LMV841/LMV844 have good noise specifications, and will frequently be used in low-noise applications. Therefore it is important to take into account the influence of the resistors on the total noise contribution.

For applications with a voltage input configuration it is, in general, beneficial to keep the resistor values low. In these configurations high resistor values mean high noise levels.

However, using low resistor values will increase the power consumption of the application. This is not always acceptable for portable applications.

To determine if the noise is acceptable for the application, use the following formula for resistor noise :

$$e_{th} = \sqrt{4kTRB}$$

where:

$e_{th}$  = Thermal noise voltage (Vrms)

k = Boltzmann constant (1.38 x 10<sup>-23</sup> J/K)

T = Absolute temperature (K)

R = Resistance (Ω)

B = Noise bandwidth (Hz), fmax - fmin

Given in an example with a resistor of 1MΩ at 25°C (298 K) over a frequency range of 100 kHz:

$$\begin{aligned} e_{th} &= \sqrt{4kTRB} \\ &= \sqrt{4 \times 1.38 \times 10^{-23} \text{ J/K} \times 298 \text{ K} \times 1 \text{ M}\Omega \times 100 \text{ kHz}} \\ &= 40 \mu\text{V} = -88 \text{ dBV} \end{aligned}$$

To keep the noise of the application low it might be necessary to decrease the resistors to 100k, which will decrease the noise to -97.8 dBV (12.8 μV).

The op amp's input-referred noise of 20 nV/√Hz at 1 kHz is equivalent to the noise of a 24 kΩ resistor.

### ACTIVE FILTER

The rail-to-rail input and output of the LMV841/LMV844 and the wide supply voltage range make these amplifiers ideal to use in numerous applications. One of the typical applications is an active filter as shown in *Figure 3*. This example is a band-pass filter, for which the pass band is widened. This is achieved by cascading two band-pass filters, with slightly different center frequencies.

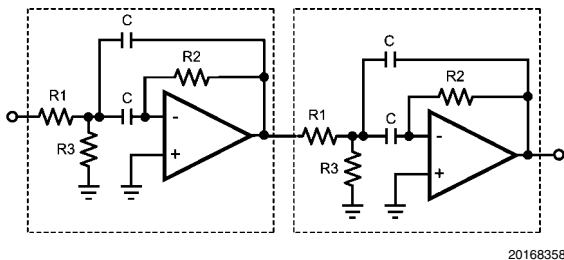

**FIGURE 3. Active Filter**

The center frequency of the separate band-pass filters can be calculated by:

$$f_{mid} = \frac{1}{2\pi C} \sqrt{\frac{R_1 + R_3}{R_1 R_2 R_3}}$$

In this example a filter was designed with its pass band at 10 kHz. The two separate band-pass filters are designed to have

a center frequency of approximately 10% from the frequency of the total filter:

C = 33 nF

R1 = 2 kΩ

R2 = 6.2 kΩ

R3 = 45 Ω

This will give for filter A:

$$f_{mid} = \frac{1}{\pi \times 33 \text{ nF}} \sqrt{\frac{2 \text{ k}\Omega + 6.2 \text{ k}\Omega}{2 \text{ k}\Omega \times 6.2 \text{ k}\Omega \times 45 \Omega}} = 9.2 \text{ kHz}$$

And for filter B with C = 27 nF:

$$f_{mid} = \frac{1}{\pi \times 27 \text{ nF}} \sqrt{\frac{2 \text{ k}\Omega + 6.2 \text{ k}\Omega}{2 \text{ k}\Omega \times 6.2 \text{ k}\Omega \times 45 \Omega}} = 11.2 \text{ kHz}$$

Bandwidth can be calculated by:

$$B = \frac{1}{\pi R_2 C}$$

For filter A this will give

$$B = \frac{1}{\pi \times 6.2 \text{ k}\Omega \times 33 \text{ nF}} = 1.6 \text{ kHz}$$

and for filter B:

$$B = \frac{1}{\pi \times 6.2 \text{ k}\Omega \times 27 \text{ nF}} = 1.9 \text{ kHz}$$

The response of the two filters and the combined filter is shown in *Figure 4*.

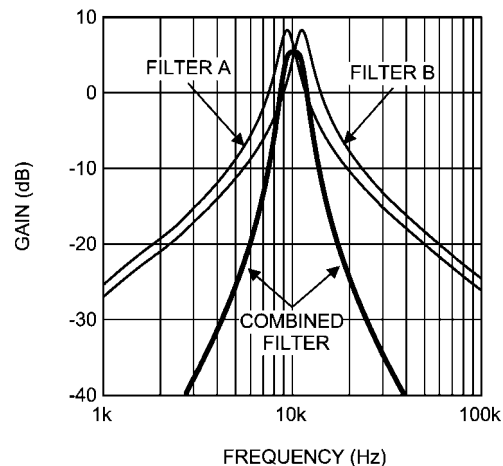

**FIGURE 4. Active Filter Curve**

The filter responses of filter A and filter B are shown as the thin lines in *Figure 4*, the response of the combined filter is shown as the thick line. Shifting the center frequencies of the separate filters farther apart, will result in a wider band, however positioning the center frequencies too far apart will result in a less flat gain within the band. For wider bands more band-pass filters can be cascaded.

Tip: Use the WEBENCH internet tools at [www.national.com](http://www.national.com) for your filter application.

### HIGH-SIDE CURRENT SENSING

The rail-to-rail input and the low  $V_{OS}$  features make the LMV841/844 ideal op amps for high-side current sensing application.

To measure a current, a sense resistor is placed in series with the load, as shown in *Figure 5*. The current flowing through this sense resistor will result in a voltage drop, that is amplified by the op amp.

Suppose we need to measure a current between 0A and 2A using a sense resistor of 100 mΩ, and convert it to an output voltage of 0 to 5V. A current of 2A flowing through the load and the sense resistor will result in a voltage of 200 mV across the sense resistor. The op amp will amplify this 200 mV to fit the current range to the output voltage range. We can use the formula:

$$V_{OUT} = R_F / R_G * V_{SENSE}$$

to calculate the gain needed. For a load current of 2A and an output voltage of 5V the gain would be  $V_{OUT} / V_{SENSE} = 25$ .

When we use a feedback resistor,  $R_F$ , of 100 kΩ the value for  $R_G$  would be 4 kΩ. The tolerance of the resistors has to be low to obtain a good common-mode rejection.

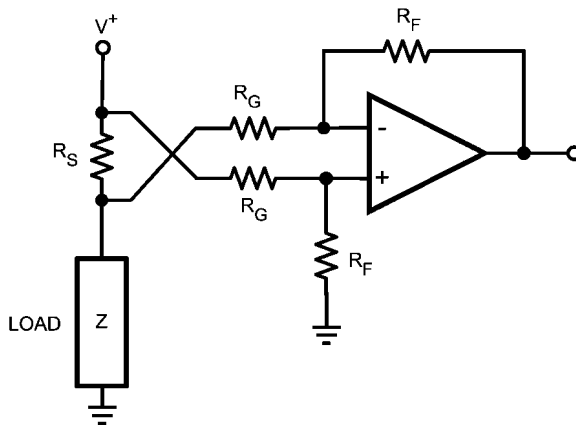

20168371

**FIGURE 5. High-Side Current Sensing**

### HIGH IMPEDANCE SENSOR INTERFACE

With CMOS inputs, the LMV841/LMV844 are particularly suited to be used as high impedance sensor interfaces.

Many sensors have high source impedances that may range up to 10 MΩ. The input bias current of an amplifier will load the output of the sensor, and thus cause a voltage drop across the source resistance, as shown in *Figure 6*. When an op amp is selected with a relatively high input bias current, this error may be unacceptable.

The low input current of the LMV841/LMV844 significantly reduces such errors. The following examples show the difference between a standard op amp input and the CMOS input of the LMV841/LMV844.

The voltage at the input of the op amp can be calculated by

$$V_{IN+} = V_S - I_B * R_S$$

For a standard op amp the input bias  $I_B$  could be 10 nA. When the sensor generates a signal of 1V ( $V_S$ ) and the sensors impedance is 10 MΩ ( $R_S$ ), the signal at the op amp input will be

$$V_{IN} = 1V - 10 \text{ nA} * 10 \text{ M}\Omega = 1V - 0.1V = 0.9V$$

For the CMOS input of the LMV841/LMV844, which has an input bias current of only 0.3 pA, this would give

$$V_{IN} = 1V - 0.3 \text{ pA} * 10 \text{ M}\Omega = 1V - 3 \mu\text{V} = 0.999997 \text{ V} !$$

The conclusion is that a standard op amp, with its high input bias current input, is not a good choice for use in impedance sensor applications. The LMV841/LMV844, in contrast, are much more suitable due to the low input bias current. The error is negligibly small, therefore the LMV841/LMV844 are a must for use with high impedance sensors.

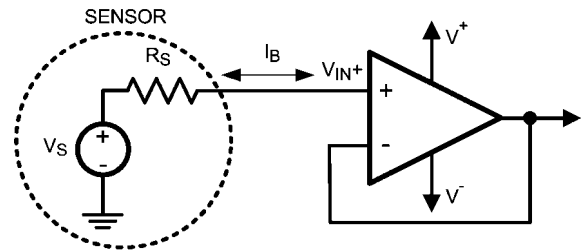

20168352

**FIGURE 6. High Impedance Sensor Interface**

### THERMOCOUPLE AMPLIFIER

The following is a typical example for a thermocouple amplifier application with an LMV841/LMV844. A thermocouple senses a temperature and converts it into a voltage. This signal is then amplified by the LMV841. An ADC can then convert the amplified signal to a digital signal. For further processing the digital signal can be processed by a microprocessor and can be used to display or log the temperature, or use the temperature data in a fabrication process.

### Characteristics of a Thermocouple

A thermocouple is a junction of two different metals. These metals produce a small voltage that increases with temperature.

The thermocouple used in this application is a K-type thermocouple. A K-type thermocouple is a junction between Nickel-Chromium and Nickel-Aluminum. This type is one of the most commonly used thermocouples. There are several reasons for using the K-type thermocouple. These include temperature range, the linearity, the sensitivity and the cost.

A K-type thermocouple has a wide temperature range. The range of this thermocouple is from approximately -200°C to approximately 1200°C, as can be seen in *Figure 7*. This covers the generally used temperature ranges.

Over the main part of the range the behavior is linear. This is important for converting the analog signal to a digital signal.

The K-type thermocouple has good sensitivity when compared to many other types, the sensitivity is 41 μV/°C. Lower sensitivity requires more gain and makes the application more sensitive to noise.

In addition, a K-type thermocouple is not expensive, many other thermocouples consist of more expensive materials or are more difficult to produce.

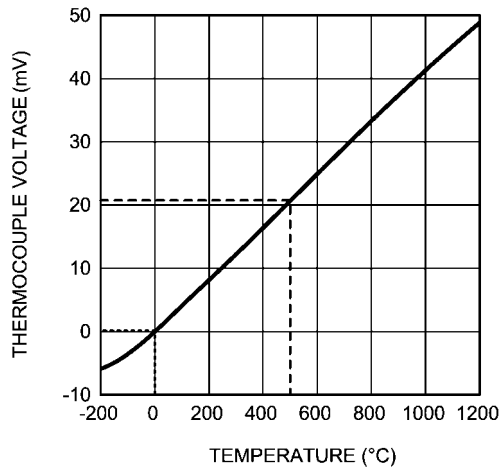

20168370

**FIGURE 7. K-Type Thermocouple Response**

**Thermocouple Example**

Suppose the range we are interested in for this example is from 0°C to 500°C, and the resolution needed is 0.5°C. The power supply for both the LMV841 and the ADC is 3.3V.

The temperature range of 0°C to 500°C results in a voltage range from 0 mV to 20.6 mV produced by the thermocouple. This is shown in *Figure 7*

To obtain the best accuracy the full ADC range of 0 to 3.3V is used.

We can calculate the gain we need for the full input range of the ADC :  $A_V = 3.3V / 0.0206V = 160$ .

When we use 2 kΩ for  $R_G$ , we can calculate the value for  $R_F$  with this gain of 160. We can use  $A_V = R_F / R_G$  to calculate the gain, so we can calculate  $R_F$  by using  $R_F = A_V \times R_G = 160 \times 2 \text{ k}\Omega = 320 \text{ k}\Omega$ .

To get a resolution of 0.5°C we need a step smaller than the minimum resolution, this means we need at least 1000 steps (500°C / 0.5°C). A 10-bit ADC would be sufficient as this will give us 1024 steps. This could be a 10 bit ADC like the two channel 10-bit ADC102S021.

**Unwanted Thermocouple Effect**

At the point where the thermocouple wires are connected to the circuit, usually copper wires or traces, an unwanted thermocouple effect will occur.

At this connection, this could be the connector on a PCB, the thermocouple wiring forms a second thermocouple with the connector. This second thermocouple disturbs the measurements from the intended thermocouple.

We can compensate for this thermocouple effect by using an isothermal block as a reference. An isothermal block is a good heat conductor. This means that the two thermocouple connections both have the same temperature. We can now measure the temperature of the isothermal block, and thereby the temperature of the thermocouple connections. This is usually called the cold junction reference temperature.

In the example, an LM35 is used to measure this temperature. This semiconductor temperature sensor can accurately measure temperatures from -55°C to 150°C.

The ADC in this example also converts the signal from the LM35 to a digital signal. Now the microprocessor can compensate the amplified thermocouple signal, for the unwanted thermocouple effect.

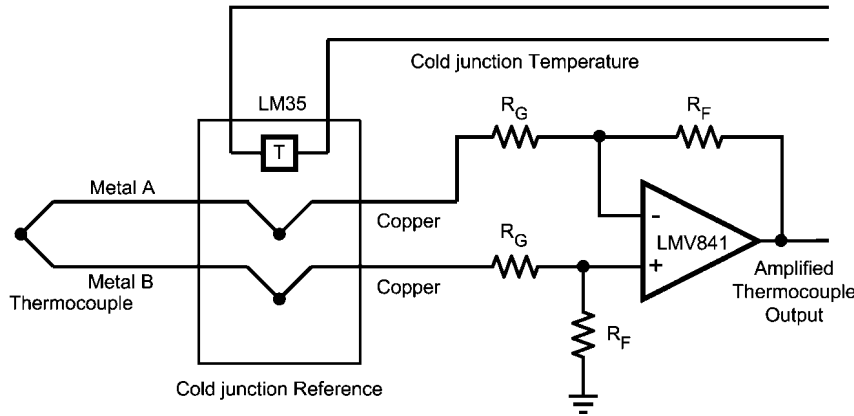

20168353

**FIGURE 8. Thermocouple Amplifier**

**Physical Dimensions** inches (millimeters) unless otherwise noted

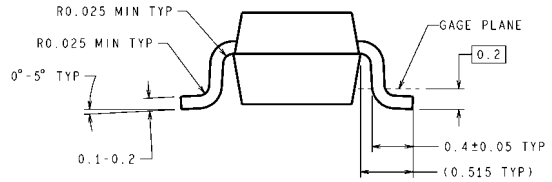
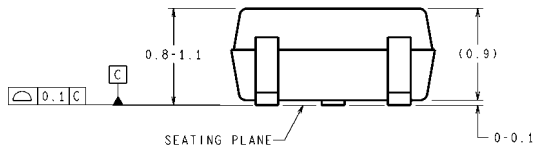
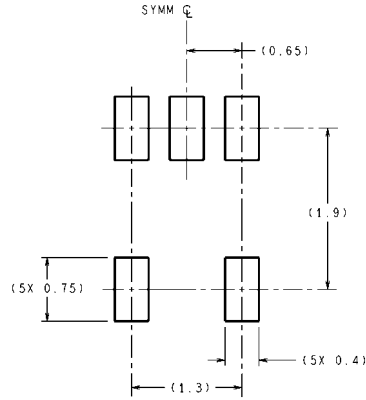
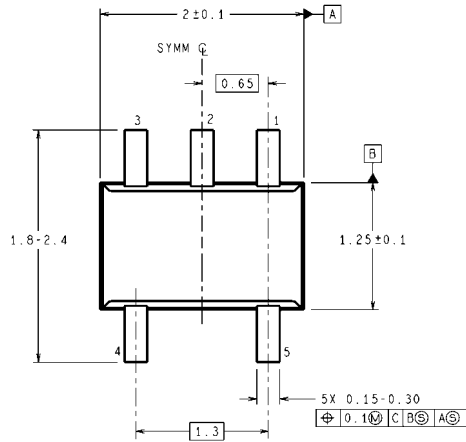

DIMENSIONS ARE IN MILLIMETERS  
**5-Pin SC70**  
 NS Package Number MAA05A

MAA05A (Rev C)

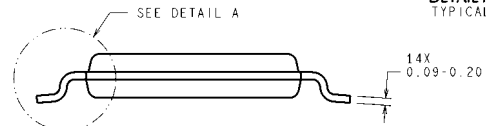
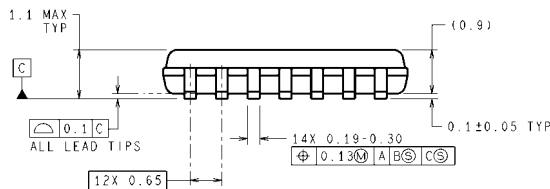
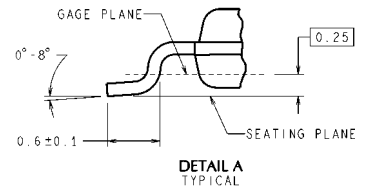
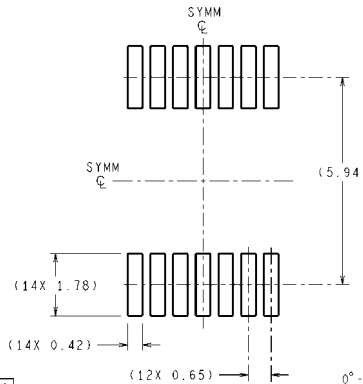
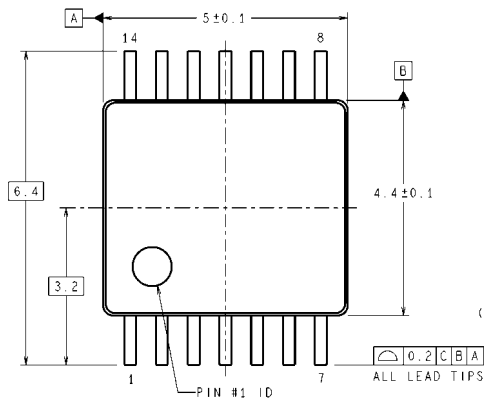

DIMENSIONS ARE IN MILLIMETERS  
 DIMENSIONS IN { } FOR REFERENCE ONLY

**14-Pin TSSOP**  
 NS Package Number MTC14

MTC14 (Rev D)



# Notes

## Notes

THE CONTENTS OF THIS DOCUMENT ARE PROVIDED IN CONNECTION WITH NATIONAL SEMICONDUCTOR CORPORATION ("NATIONAL") PRODUCTS. NATIONAL MAKES NO REPRESENTATIONS OR WARRANTIES WITH RESPECT TO THE ACCURACY OR COMPLETENESS OF THE CONTENTS OF THIS PUBLICATION AND RESERVES THE RIGHT TO MAKE CHANGES TO SPECIFICATIONS AND PRODUCT DESCRIPTIONS AT ANY TIME WITHOUT NOTICE. NO LICENSE, WHETHER EXPRESS, IMPLIED, ARISING BY ESTOPPEL OR OTHERWISE, TO ANY INTELLECTUAL PROPERTY RIGHTS IS GRANTED BY THIS DOCUMENT.

TESTING AND OTHER QUALITY CONTROLS ARE USED TO THE EXTENT NATIONAL DEEMS NECESSARY TO SUPPORT NATIONAL'S PRODUCT WARRANTY. EXCEPT WHERE MANDATED BY GOVERNMENT REQUIREMENTS, TESTING OF ALL PARAMETERS OF EACH PRODUCT IS NOT NECESSARILY PERFORMED. NATIONAL ASSUMES NO LIABILITY FOR APPLICATIONS ASSISTANCE OR BUYER PRODUCT DESIGN. BUYERS ARE RESPONSIBLE FOR THEIR PRODUCTS AND APPLICATIONS USING NATIONAL COMPONENTS. PRIOR TO USING OR DISTRIBUTING ANY PRODUCTS THAT INCLUDE NATIONAL COMPONENTS, BUYERS SHOULD PROVIDE ADEQUATE DESIGN, TESTING AND OPERATING SAFEGUARDS.

EXCEPT AS PROVIDED IN NATIONAL'S TERMS AND CONDITIONS OF SALE FOR SUCH PRODUCTS, NATIONAL ASSUMES NO LIABILITY WHATSOEVER, AND NATIONAL DISCLAIMS ANY EXPRESS OR IMPLIED WARRANTY RELATING TO THE SALE AND/OR USE OF NATIONAL PRODUCTS INCLUDING LIABILITY OR WARRANTIES RELATING TO FITNESS FOR A PARTICULAR PURPOSE, MERCHANTABILITY, OR INFRINGEMENT OF ANY PATENT, COPYRIGHT OR OTHER INTELLECTUAL PROPERTY RIGHT.

### LIFE SUPPORT POLICY

**NATIONAL'S PRODUCTS ARE NOT AUTHORIZED FOR USE AS CRITICAL COMPONENTS IN LIFE SUPPORT DEVICES OR SYSTEMS WITHOUT THE EXPRESS PRIOR WRITTEN APPROVAL OF THE CHIEF EXECUTIVE OFFICER AND GENERAL COUNSEL OF NATIONAL SEMICONDUCTOR CORPORATION.** As used herein:

Life support devices or systems are devices which (a) are intended for surgical implant into the body, or (b) support or sustain life and whose failure to perform when properly used in accordance with instructions for use provided in the labeling can be reasonably expected to result in a significant injury to the user. A critical component is any component in a life support device or system whose failure to perform can be reasonably expected to cause the failure of the life support device or system or to affect its safety or effectiveness.

National Semiconductor and the National Semiconductor logo are registered trademarks of National Semiconductor Corporation. All other brand or product names may be trademarks or registered trademarks of their respective holders.

Copyright© 2007 National Semiconductor Corporation

For the most current product information visit us at [www.national.com](http://www.national.com)



**National Semiconductor Americas Customer Support Center**  
 Email: [new.feedback@nsc.com](mailto:new.feedback@nsc.com)  
 Tel: 1-800-272-9959

**National Semiconductor Europe Customer Support Center**  
 Fax: +49 (0) 180-530-85-86  
 Email: [europe.support@nsc.com](mailto:europe.support@nsc.com)  
 Deutsch Tel: +49 (0) 69 9508 6208  
 English Tel: +49 (0) 870 24 0 2171  
 Français Tel: +33 (0) 1 41 91 8790

**National Semiconductor Asia Pacific Customer Support Center**  
 Email: [ap.support@nsc.com](mailto:ap.support@nsc.com)

**National Semiconductor Japan Customer Support Center**  
 Fax: 81-3-5639-7507  
 Email: [jpn.feedback@nsc.com](mailto:jpn.feedback@nsc.com)  
 Tel: 81-3-5639-7560