

REV	Description	Date	Approved
PR-B	Preliminary Release	6/1/00	
PR-C	Revised Graph sizes (Prelim)	10/25/00	
PR-D	Update Outline Drawing	12/21/00	
PR-E	New P/N's / Standoff locations	3/13/01	KTF
PR-F	Revised Part Numbers Added -M1 Option	3/28/01	
PR-G	Update Various Specifications	4-5-01	KTF



**TECHNICAL REFERENCE
NOTED (TRN)**

**AK45C 100 WATT
SERIES**

DC-DC CONVERTER

ASTEC POWER

ANDOVER, MA

Electrical Specifications

Absolute Maximum Ratings

Stresses in excess of the absolute maximum ratings can cause permanent damage to the device. These are absolute stress ratings only. Functional operation of the device is not implied at these or any other conditions in excess of those given in the operational sections of the IPS. Exposure to absolute maximum ratings for extended periods can adversely affect device reliability.

Table 1. Absolute Maximum Ratings

Parameter	Device	Symbol	Min	Typ	Max	Unit
Input Voltage:						
Continuous:	All	V_I	0	-	75	Vdc
Transient (100ms)	All	$V_{I,trans}$	0	-	100	Vdc
Operating Case Temperature	All	T_c	-40	-	100	°C
Storage Temperature	All	T_{stg}	-55	-	125	°C
Operating Humidity	All	-	-	-	95	%
I/O Isolation	All	-	-	-	1500	Vdc

Input Specifications

Table 2. Input Specifications

Parameter	Device	Symbol	Min	Typ	Max	Unit
Operating Input Voltage	All	V_I	36	48	75	Vdc
Maximum Input Current ($V_I = 0$ to $V_{I,max}$: $I_o = I_{o,max}$)	018FHX 025FHX 033FHX 050FHX	$I_{I,max}$ $I_{I,max}$ $I_{I,max}$ $I_{I,max}$	- - - -	- - - -	2.00 2.50 3.00 4.00	A A A A
Input Reflected-ripple Current (5Hz to 20MHz: 12uH source impedance: $T_A = 25$ °C.) See Figure 10.	All	I_I	-	-	10	mAp-p
Ripple Current into External Input Cap	All	I_{IC}	-	-	250	mARMS
No Load Input Power ($V_I = V_{I,nom}$)	All	-	-	5	-	W

CAUTION: This power module is not internally fused. An input line fuse must always be used.

Output Specifications

Table 3. Output Specifications

Parameter	Device	Symbol	Min	Typ	Max	Unit	
Output Voltage Setpoint ($V_I = V_{I,min}$ to $V_{I,max}$; $I_o = I_{o,max}$; $T_A = 25\text{ }^\circ\text{C}$)	018FHX	$V_{o,set}$	1.77	1.8	1.83	Vdc	
	025FHX	$V_{o,set}$	2.46	2.5	2.54	Vdc	
	033FHX	$V_{o,set}$	3.25	3.3	3.35	Vdc	
	050FHX	$V_{o,set}$	4.92	5.0	5.08	Vdc	
Output Regulation: Line ($V_I = V_{I,min}$ to $V_{I,max}$) Load ($I_o = I_{o,min}$ to $I_{o,max}$)	018FHX	-	-	2	4	mV	
	025FHX	-	-	2	5	mV	
Line ($V_I = V_{I,min}$ to $V_{I,max}$) Load ($I_o = I_{o,min}$ to $I_{o,max}$)	033FHX	-	-	0.05	0.1	% V_o	
	050FHX	-	-	0.1	0.2	% V_o	
Temperature ($T_C = -40\text{ }^\circ\text{C}$ to $+100\text{ }^\circ\text{C}$)	All	-	-	15	50	mV	
Output Ripple and Noise (Across 0.1 μ F ceramic and 10 μ F tantalum capacitors) See Figure 11.	All	-	-	-	100	mVp-p	
		-	-	-	30	mV _{RMS}	
External Load Capacitance	All*	-	0	-	4700	μ F	
Output Current	018FHX	I_o	0	-	20	A	
	025FHX	I_o	0	-	20	A	
	033FHX	I_o	0	-	20	A	
	050FHX	I_o	0	-	20	A	
Output Current-limit Inception ($V_o = 90\% V_{o,set}$)	018FHX	I_o	-	-	30	A	
	025FHX	I_o	-	-	30	A	
	033FHX	I_o	-	-	30	A	
	050FHX	I_o	-	-	30	A	
Output Short-circuit Current ($V_o = 250\text{mV}$)	All	-	-	-	190	% $I_{o,max}$	
Efficiency ($V_I = V_{I,nom}$; $I_o = I_{o,max}$; $T_C = 70\text{ }^\circ\text{C}$)	018FHX	I_o	80	82	-	%	
	025FHX	I_o	82	84	-	%	
	033FHX	I_o	84	86	-	%	
	050FHX	I_o	84	86	-	%	
Switching Frequency	018FX	f	-	310	-	kHz	
	025FX	f	-	310	-	kHz	
	033FX	f	-	380	-	kHz	
	050FX	f	-	310	-	kHz	
Dynamic Response: ($? I_o / ? t = 1\text{A}/10\text{us}$; $V_I = V_{I,nom}$; $T_A = 25\text{ }^\circ\text{C}$)	Load Change from $I_o = 50\%$ to 75% of I_o , max: Peak Deviation Settling Time	All	-	-	4	% V_o usec	
		-	-	-	400		
	Load Change from $I_o = 50\%$ to 25% of I_o , max: Peak Deviation Settling Time	All	-	-	4	% V_o usec	
		-	-	-	400		
	Turn-on Time ($I_o = I_{o,max}$; V_o within 1%)	All	-	-	2	5	msec
	Output Voltage Overshoot ($I_o = I_{o,max}$; $T_A = 25\text{ }^\circ\text{C}$)	All	-	-	-	5	% V_o

*External load capacitance greater than 4700uF but less than 10,000uF can be used except that the maximum overshoot may exceed 5%.

Isolation Specifications

Table 4. Isolation Specifications

Parameter	Device	Symbol	Min	Typ	Max	Unit
Isolation Capacitance	All	-	-	2300	-	pF
Isolation Resistance	All	-	-	1000	-	Mohm

General Specifications

Table 5. General Specifications

Parameter	Device	Symbol	Min	Typ	Max	Unit
Calculated MTBF (I _o = I _{o,max} ; T _c = 25 °C)	All	-	-	TBD	-	hours
Weight	All	-	-	-	60(2.2)	g (oz.)

Feature Specifications

Table 6. Feature Specifications

Parameter	Device	Symbol	Min	Typ	Max	Unit
Remote On/Off Signal Interface: ($V_I = 0$ to $V_{I,max}$; Open collector or equivalent compatible; Signal referenced to $V_I (-)$ terminal.)						
Positive Logic – No Suffix Low Logic – Module Off High Logic – Module On						
Negative Logic –Suffix “N” Low Logic – Module On High Logic – Module Off						
Module Specifications:						
On/Off Current – Logic Low	All	Ion/off	-	-	1.0	mA
On/Off Voltage:						
Logic Low	All	Von/off	-0.7	-	1.2	V
Logic High (Ion/off = 0)	All	Von/off	-	-	10	V
Open Collector Switch Specifications:						
Leakage Current – Logic High (Von/off = 10V)	All	Ion/off	-	-	50	uA
Output Voltage – Logic Low (Ion/off = 1mA)	All	Von/off	-	-	1.2	V
Output Voltage Adjustment						
Remote Sense Range	All	-	-	-	0.5	V
Voltage Adjustment Range	All	-	80	-	110	%Vo
Output Overvoltage Clamp	018FHX 025FHX 033FHX 050FHX	Vo,clamp Vo,clamp Vo,clamp Vo,clamp	2.4 3.1 3.9 5.9	- - - -	2.7 3.5 4.6 7.0	V V V V
Overtemperature Shutdown	All	Tc	105	110	120	°C
Undervoltage Lockout						
Turn-on Point	All	-	-	34.5	35	V
Turn-off Point	All	-	32	32.5	-	V

Characteristic Curves

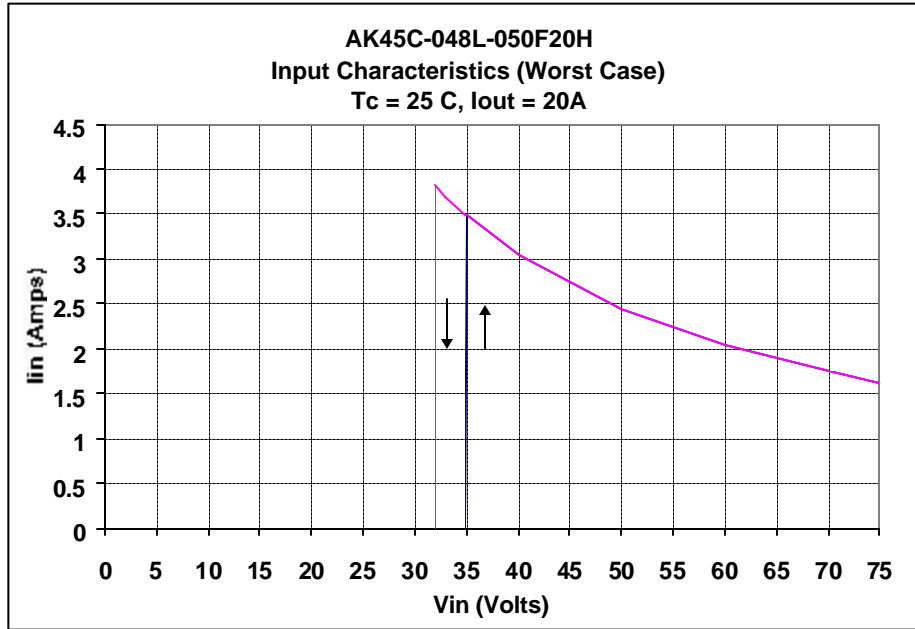

Figure 1. Typical Input Current vs Input Voltage.

Characteristic Curves (Continued)

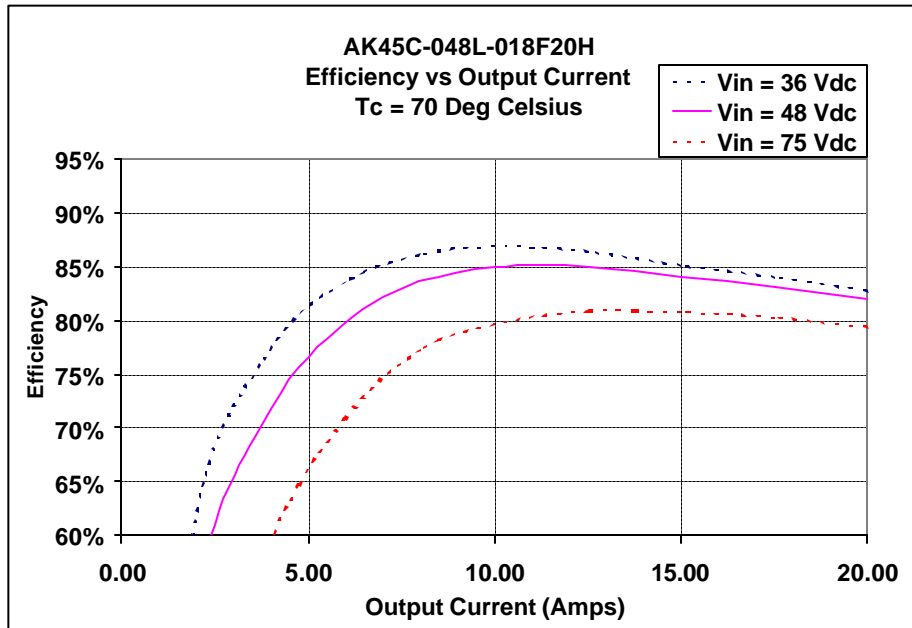

Figure 2. 018S, Efficiency vs Load Current.

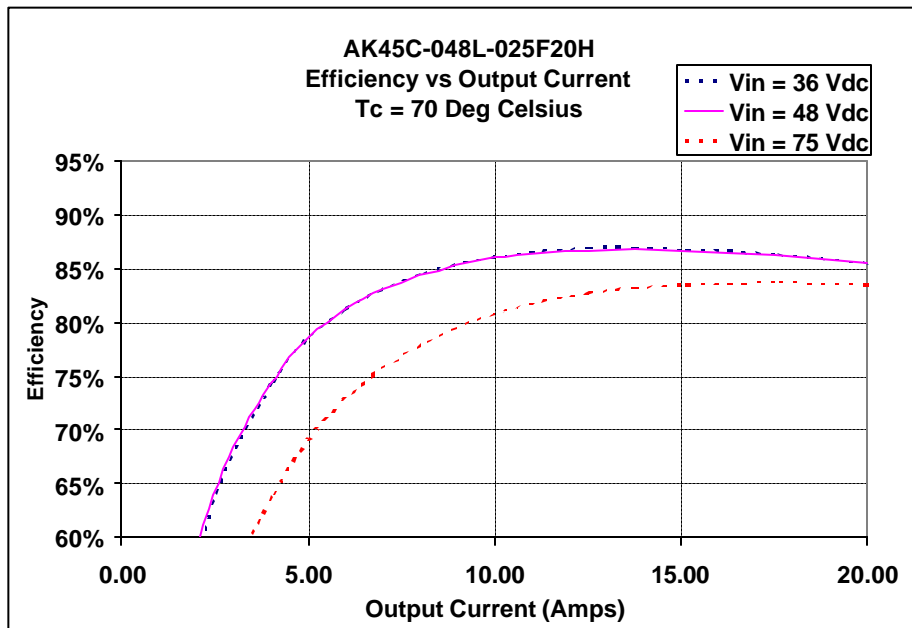

Figure 3. 025S Efficiency vs Load Current.

Characteristic Curves (Continued)

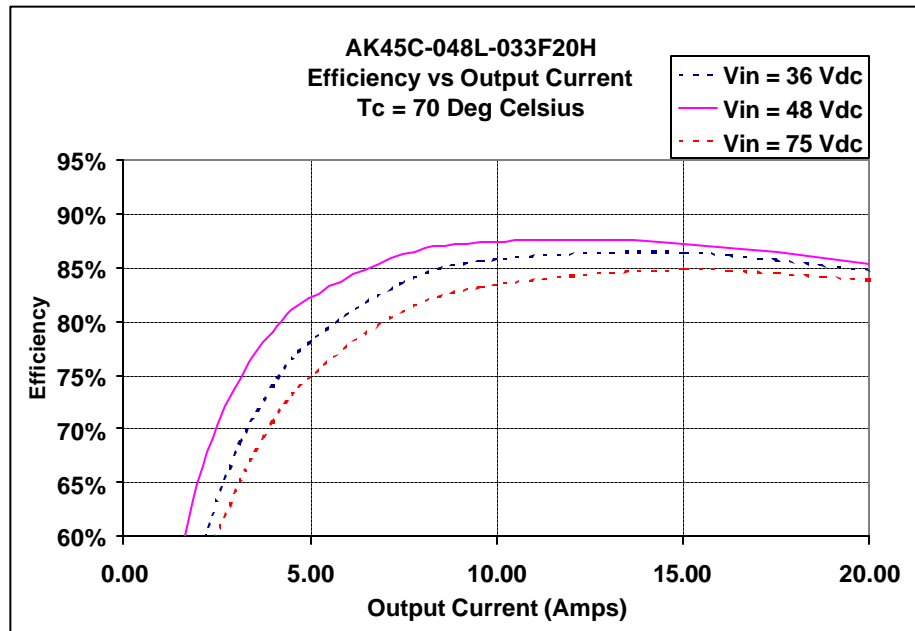

Figure 4. 033S Efficiency vs Load Current.

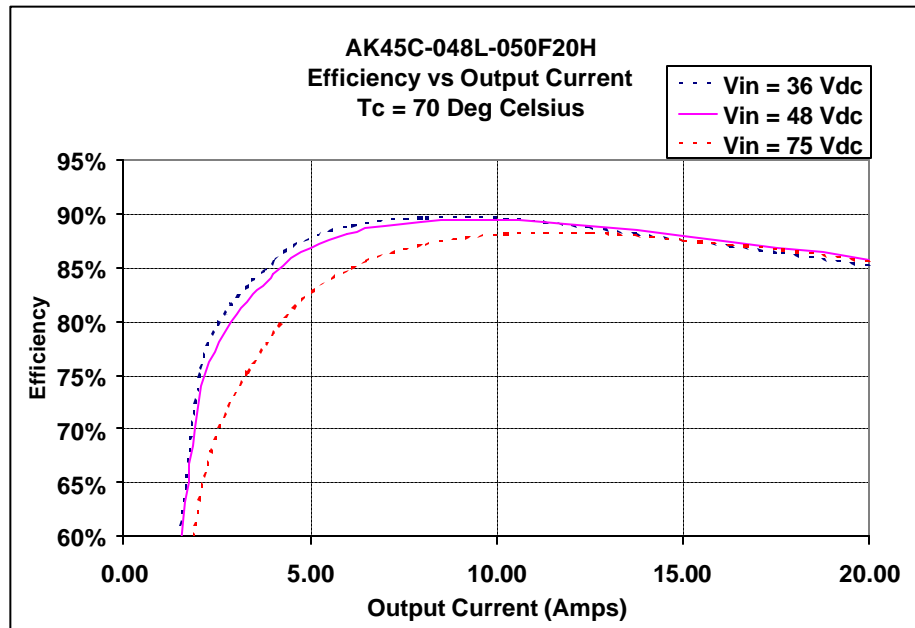

Figure 5. 050S Efficiency vs Load Current.

Characteristic Curves (Continued)

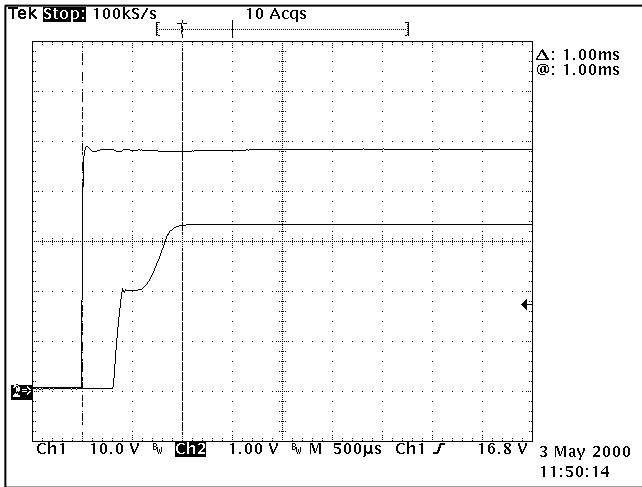

Figure 6. Typical Output Voltage Startup
 $V_i = V_{i,nom}, I_o = I_{o,max}$.

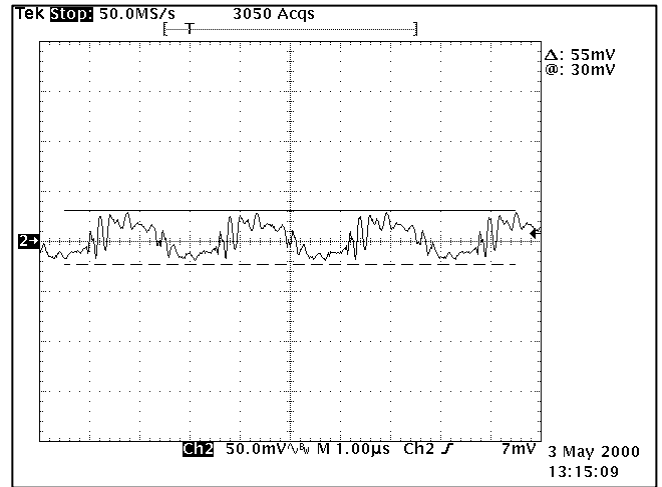

Figure 7. Typical Output Ripple
 $V_i = V_{i,nom}, I_o = I_{o,max}$.

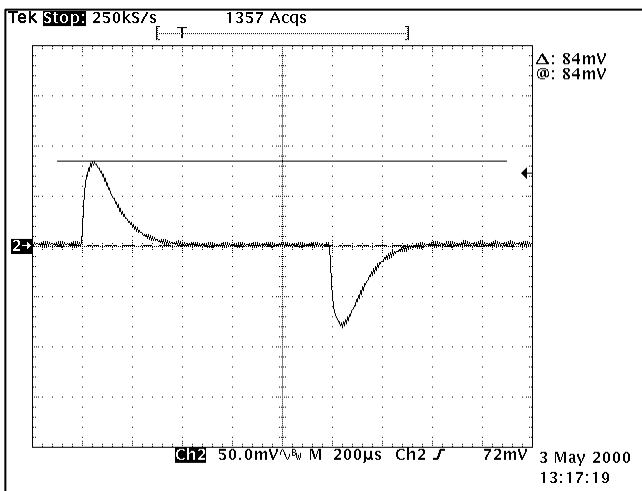

Figure 8. Typical Dynamic Response
Step Load Change from 50% to 75% $I_{o,max}$

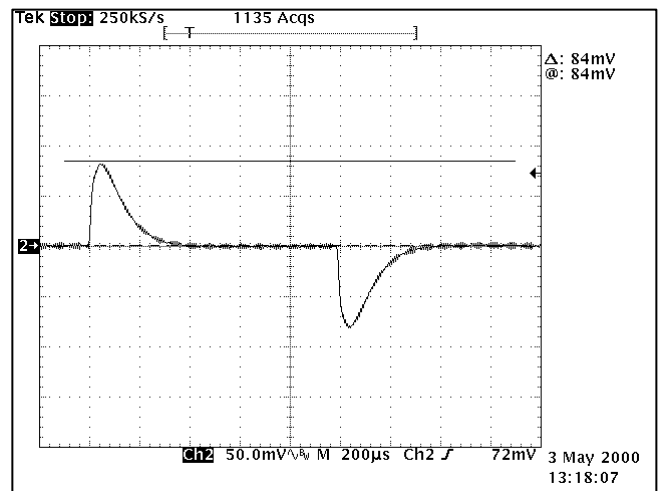
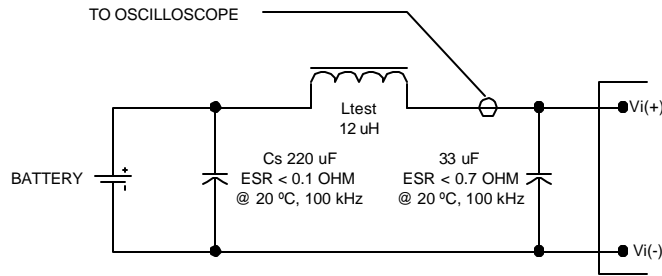

Figure 9. Typical Dynamic Response
Step Load Change from 50% to 25% $I_{o,max}$

Test Configurations



Note: Measure input reflected-ripple current with a simulated source inductance (L_{test}) of 12 uH. Capacitor Cs offsets possible battery impedance. Measure current as shown above.

Figure 10. Input Reflected-ripple Test Setup.

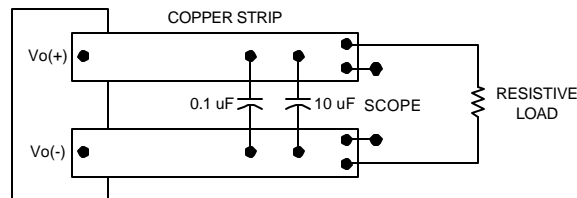

Note: Use a 0.1 uF ceramic capacitor and a 10 uF tantalum capacitor. Scope measurement should be made using a BNC socket. Position the load between 51 mm and 76 mm (2 in. and 3 in.) from module.

Figure 11. Peak-to-Peak Output Noise Measurement Test Setup.

Feature Descriptions

Output Overvoltage Clamp

The output overvoltage clamp consists of a separate control loop, independent of the primary control loop. This control loop has a higher voltage setpoint than the primary loop. In a fault condition the converter goes into “Hiccup Mode”, and the output overvoltage clamp ensures that the output voltage does not exceed $V_{o,clamp,max}$. This secondary control loop provides a redundant voltage-control that reduces the risk of output overvoltage.

Output Current Protection

To provide protection in an output overload or short circuit condition, the converter is equipped with current limiting circuitry and can endure the fault condition for an unlimited duration. At the point of current-limit inception, the converter goes into “Hiccup Mode”, causing the output current to be limited both in peak and duration. The converter operates normally once the output current is brought back into its specified range.

Enable (Optional)

Two enable options are available. Positive Logic Enable, no suffix, and Negative Logic Enable, suffix “N”. Positive Logic Enable turns the converter on during a logic-high voltage on the enable pin, and off during a logic-low. Negative Logic Enable turns the converter off during a logic-high and on during a logic-low.

Output Voltage Adjustment

Output voltage adjustment is accomplished by connecting an external resistor between the Vadj Pin and either the +Vout or –Vout Pins.

With an external resistor between the Vadj Pin and -Sense Pin ($R_{adj-down}$) the output voltage set point ($V_{o,adj}$) decreases (see Figure 12). The following equation determines the required external resistor value to obtain an adjusted output voltage:

$$R_{adj_down} = \left(\frac{510}{\%V_{o,adj}} - 10.2 \right) \cdot \text{kohm}$$

Where $R_{adj-down}$ is the resistance value and $\%V_{o,adj}$ is the percent change in the output voltage.

With an external resistor between the Vadj Pin and +Sense Pin (R_{adj-up}) the output voltage set point ($V_{o,adj}$) increases (see Figure 13). The following equation determines the required external resistor value to obtain an adjusted output voltage:

$$R_{adj_up} = \left[\frac{5.1V_o(100 + \%V_{o,adj})}{1.225\%V_{o,adj}} - \frac{510}{\%V_{o,adj}} - 10.2 \right] \cdot \text{kohm}$$

Where R_{adj-up} is the resistance value and $\%V_{o,adj}$ is the percent change in the output voltage.

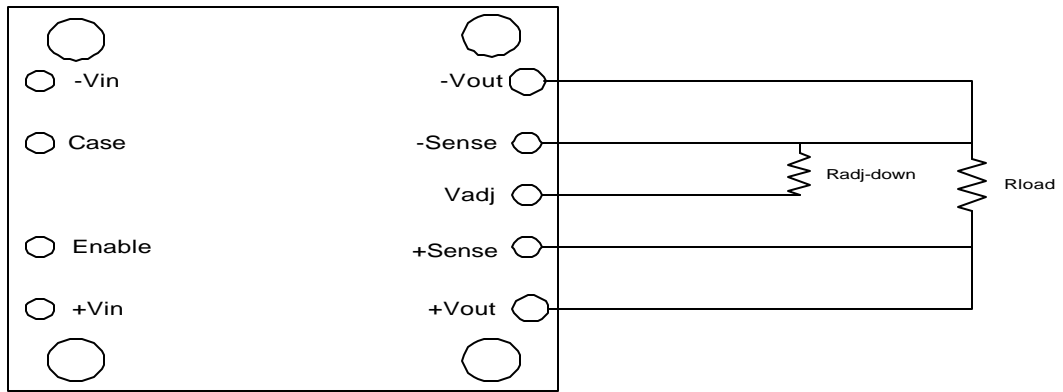

Figure 12. Circuit Configuration to Decrease Output Voltage.

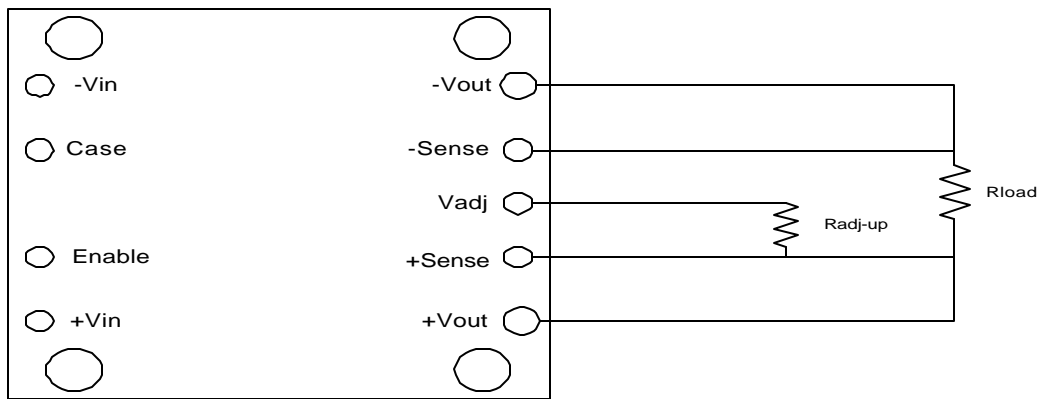

Figure 13. Circuit Configuration to Increase Output Voltage.

Thermal Considerations

The power converter operates in a variety of thermal environments: however, sufficient cooling should be provided to help ensure reliable operation of the converter. Heat-dissipating components are thermally coupled to the case. Heat is removed by conduction, convection, and radiation to the surrounding environment. Proper cooling can be verified by measuring the case temperature.

Heat Transfer Characteristics

Increasing airflow over the converter enhances the heat transfer via convection. Figure 14 shows the maximum power that can be dissipated by the converter without exceeding the maximum case temperature versus local ambient temperature (T_A) for natural convection through 2.0 m/s (400 ft/min).

Systems in which these converters are used generate airflow rates of 0.25 m/s (50 ft/min) due to other heat dissipating components in the system. Therefore, the natural convection condition represents airflow rates of approximately 0.25 m/s (50 ft/min). Use of Figure 14 is shown in the following example.

Example

What is the minimum airflow required for an 033F20 operating at 48 V, an output current of 15 A, and maximum ambient temperature of 50 °C.

Solution:

- Given: $V_i = 48\text{ V}$, $I_o = 15\text{ A}$, $T_A = 50\text{ °C}$.
- Determine P_D (Figure 17): $P_D = \sim 8\text{ W}$.
- Determine minimum airflow (Figure 14): $v = 1.0\text{ m/s}$ (200 ft/min)

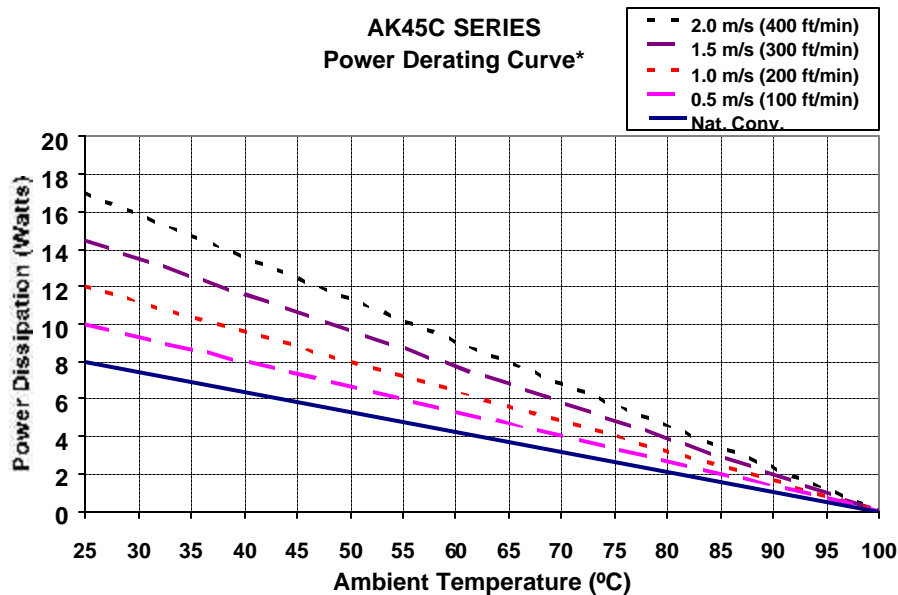

Figure 14. Forced Convection Power Derating
* longitudinal airflow, transverse airflow is more efficient and extends calculated maximum ambient by 5 °C

Thermal Considerations (continued)

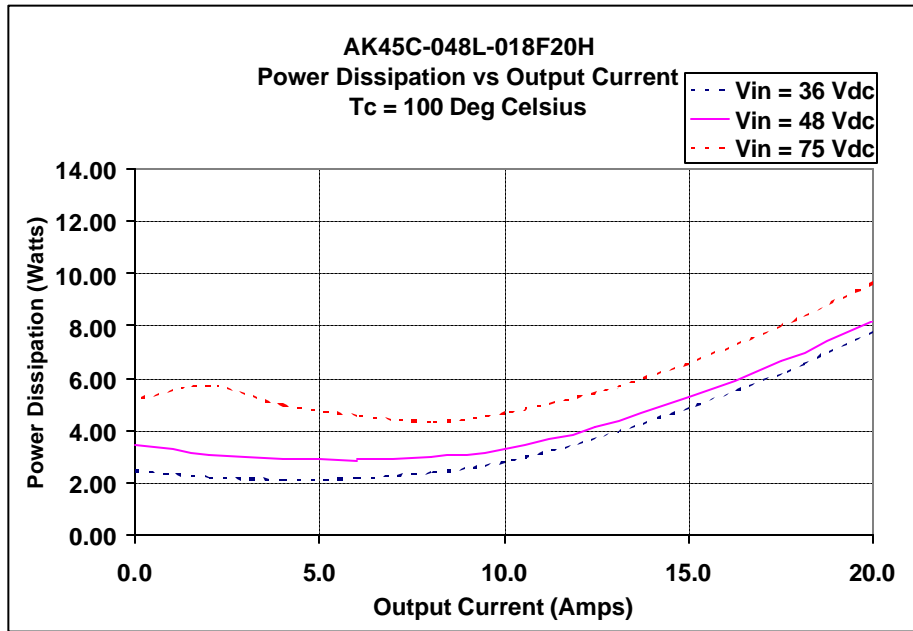

Figure 15. 018S Pwr. Diss. vs Load Current.

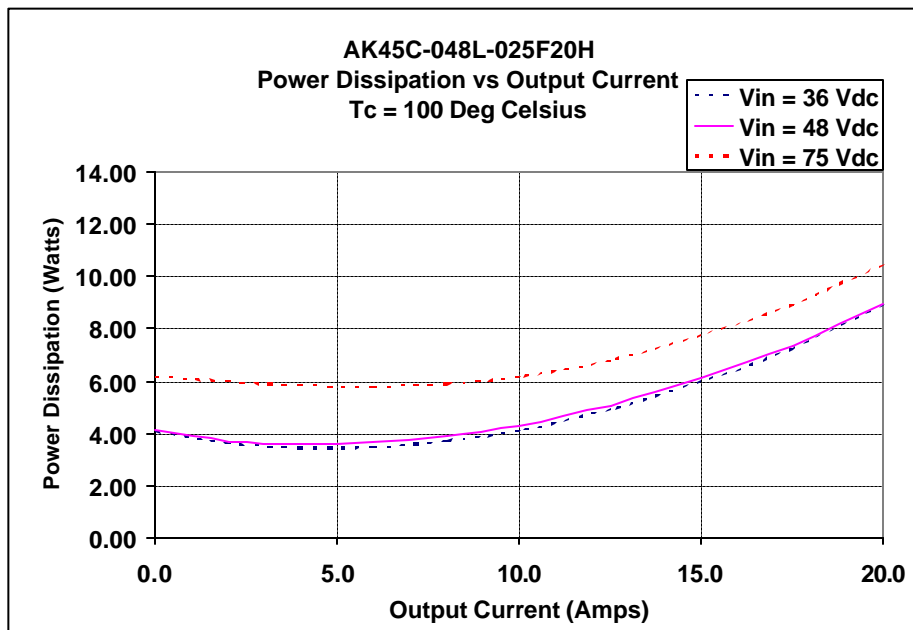

Figure 16. 025S Pwr. Diss. vs Load Current.

Thermal Considerations (continued)

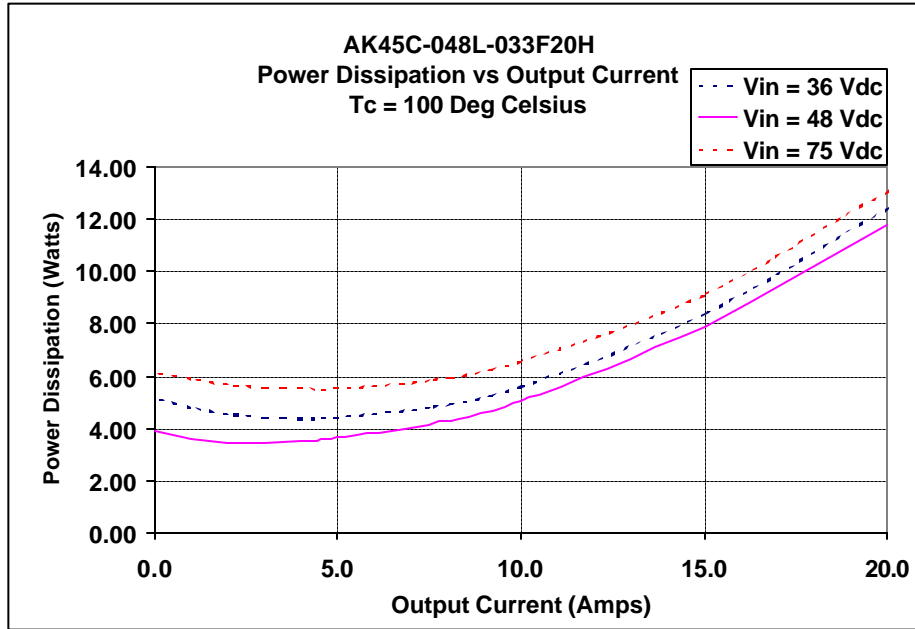

Figure 17. 033S Pwr. Diss. vs Load Current.

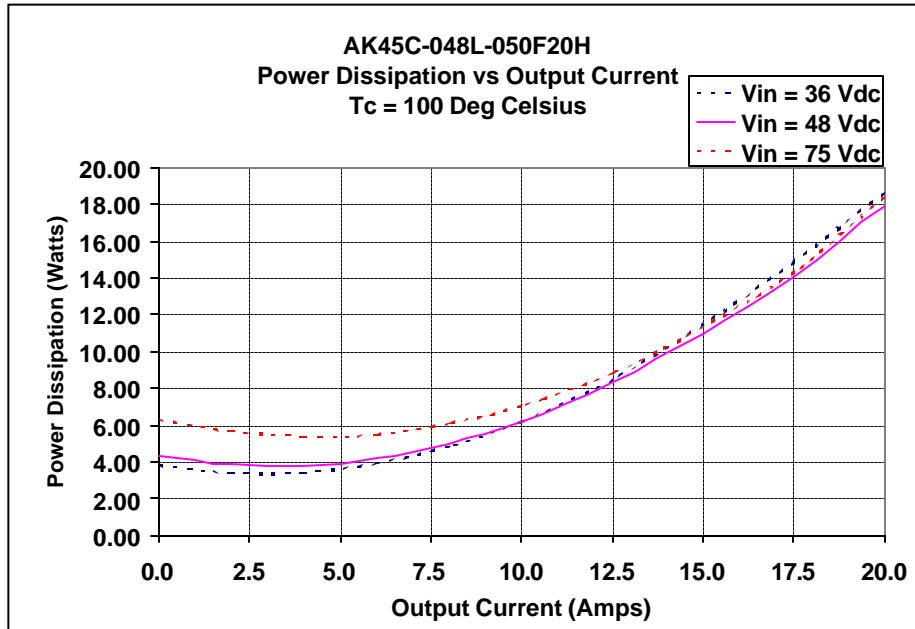
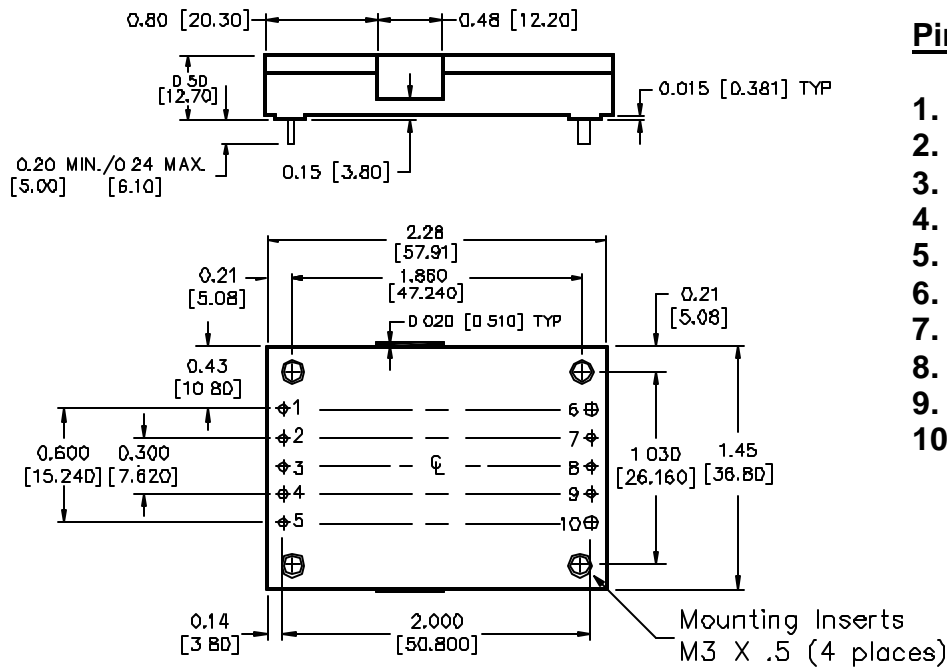

Figure 18. 050S Pwr. Diss. Vs. Load Current

Outline Drawing

Dimensions are in inches (millimeters)

Tolerances: $x.xx \pm 0.02$ in (± 0.5 mm)
 $x.xxx \pm 0.010$ in (± 0.25 mm)



Pin Assignment

1. -Vin
2. No Pin
3. Enable (on/off)
4. No pin
5. +Vin
6. - Output
7. - Sense
8. Trim
9. + Sense
10. + Output

View From Pin Side

All pins are 0.040 diameter except pins 6 & 10 which are 0.060 diameter.

Table 8. Part Numbers

Model Designation	Part Number	SIS CODE
018FH	AK45C-048L-018F20HA	AK45C048HS018
025FH	AK45C-048L-025F20HA	AK45C048HS006
033FH	AK45C-048L-033F20HA	AK45C048HS002
050FH	AK45C-048L-050F20HA	AK45C048HS003
018FHN	AK45C-048L-018F20HAN	AK45C048HS018N
025FHN	AK45C-048L-025F20HAN	AK45C048HS006N
033FHN	AK45C-048L-033F20HAN	AK45C048HS002N
050FHN	AK45C-048L-050F20HAN	AK45C048HS003N
018FH-6	AK45C-048L-018F20HA-6	AK45C048HS018-6
025FH-6	AK45C-048L-025F20HA-6	AK45C048HS006-6
033FH-6	AK45C-048L-033F20HA-6	AK45C048HS002-6
050FH-6	AK45C-048L-050F20HA-6	AK45C048HS003-6
018FHN-6	AK45C-048L-018F20HAN-6	AK45C048HS018N-6
025FHN-6	AK45C-048L-025F20HAN-6	AK45C048HS006N-6
033FHN-6	AK45C-048L-033F20HAN-6	AK45C048HS002N-6
050FHN-6	AK45C-048L-050F20HAN-6	AK45C048HS003N-6
018FH-8	AK45C-048L-018F20HA-8	AK45C048HS018-8
025FH-8	AK45C-048L-025F20HA-8	AK45C048HS006-8
033FH-8	AK45C-048L-033F20HA-8	AK45C048HS002-8
050FH-8	AK45C-048L-050F20HA-8	AK45C048HS003-8
018FHN-8	AK45C-048L-018F20HAN-8	AK45C048HS018N-8
025FHN-8	AK45C-048L-025F20HAN-8	AK45C048HS006N-8
033FHN-8	AK45C-048L-033F20HAN-8	AK45C048HS002N-8
050FHN-8	AK45C-048L-050F20HAN-8	AK45C048HS003N-8

Table 9. Options

Suffix	Option
N	Negative Logic Enable
No Suffix	Positive Logic Enable
-6	3.7 mm Pin Length
-8	2.8 mm Pin Length
-M1	¼ Inch Longitudinal Heatsink

Notes:

Cleaning after assembly:

De-ionized water is recommended for cleaning assemblies that include this product. After wash and any associated drying process step, it is recommended that the module be maintained at 100C for a period of 30 minutes to effect more complete drying of internal un-coated components such as magnetic structures with layered windings. HiPot and other electrical tests can be performed after the recommended drying procedure but some temporary degradation in results may be observed until complete drying has occurred.