

**WirelessUSB™ LP 2.4 GHz Radio SoC**

**Features**

- 2.4 GHz Direct Sequence Spread Spectrum (DSSS) radio transceiver
- Operates in the unlicensed worldwide Industrial, Scientific and Medical (ISM) band (2.400 GHz–2.483 GHz)
- 21 mA operating current (Transmit @ -5 dBm)
- Transmit power up to +4 dBm
- Receive sensitivity up to -97 dBm
- Sleep Current <1 μA
- Operating range: 10m+
- DSSS data rates up to 250 kbps, GFSK data rate of 1 Mbps
- Low external component count
- Auto Transaction Sequencer (ATS) - no MCU intervention
- Framing, Length, CRC16, and Auto ACK
- Power Management Unit (PMU) for MCU/Sensor
- Fast Startup and Fast Channel Changes
- Separate 16-byte Transmit and Receive FIFOs
- AutoRate™ - dynamic data rate reception
- Receive Signal Strength Indication (RSSI)
- Serial Peripheral Interface (SPI) control while in sleep mode
- 4 MHz SPI microcontroller interface
- Battery Voltage Monitoring Circuitry
- Supports coin-cell operated applications
- Operating voltage from 1.8V to 3.6V
- Operating temperature from 0 to 70°C
- Space saving 40-pin QFN 6x6 mm package

**Applications**

- Wireless Keyboards and Mice
- Wireless Gamepads
- Remote Controls
- Toys
- VOIP and Wireless Headsets
- White Goods
- Consumer Electronics
- Home Automation
- Automatic Meter Readers
- Personal Health and Entertainment

**Applications Support**

See [www.cypress.com](http://www.cypress.com) for development tools, reference designs, and application notes.

**Functional Description**

The CYRF6936 WirelessUSB™ LP radio is a second generation member of Cypress's WirelessUSB Radio System-On-Chip (SoC) family. The CYRF6936 is interoperable with the first generation CYWUSB69xx devices. The CYRF6936 IC adds a range of enhanced features, including increased operating voltage range, reduced supply current in all operating modes, higher data rate options, and reduced crystal start up, synthesizer settling and link turnaround times.

**CYRF6936 Simplified Block Diagram**

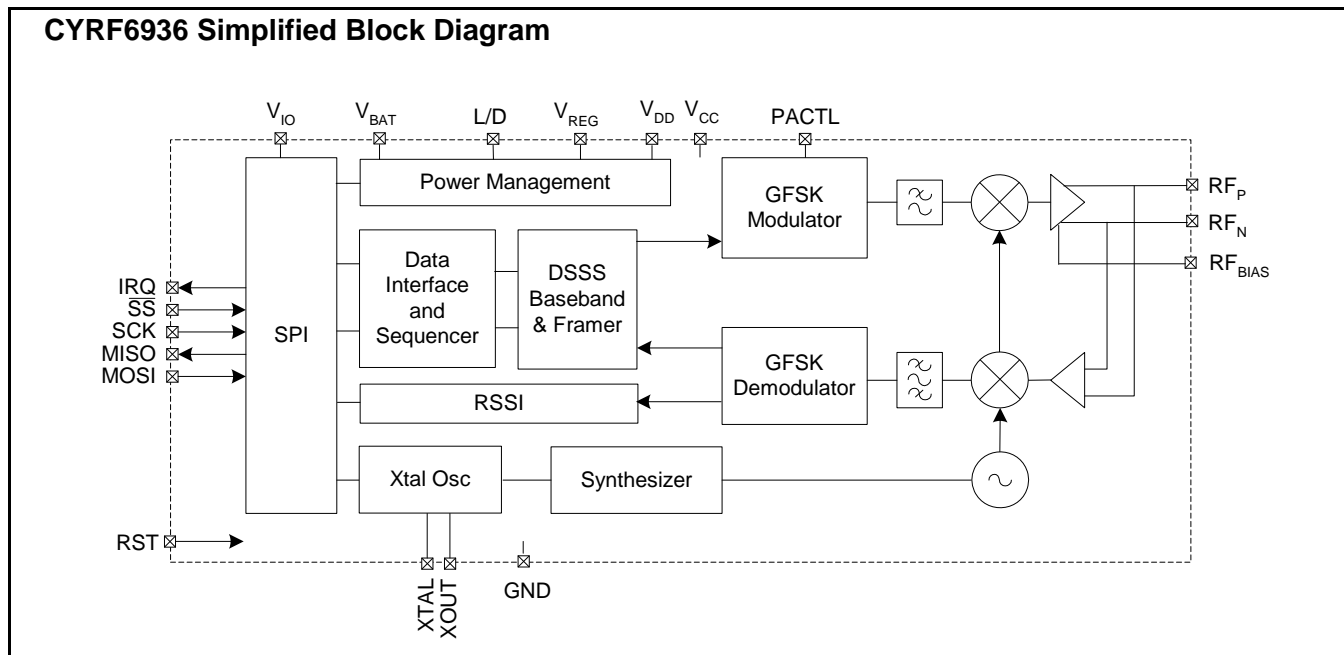

Pin Descriptions

Pin #	Name	Type	Default	Description
13	RF <sub>N</sub>	I/O	I	Differential RF signal to/from antenna
11	RF <sub>P</sub>	I/O	I	Differential RF signal to/from antenna
10	RF <sub>BIAS</sub>	O	O	RF I/O 1.8V reference voltage
30	PACTL	I/O	O	Control signal for external PA, T/R switch, or GPIO
1	XTAL	I	I	12 MHz crystal
29	XOUT	I/O	O	Buffered 0.75, 1.5, 3, 6 or 12 MHz clock, PACTL, or GPIO. Tri-states in sleep mode (configure as GPIO drive LOW)
25	SCK	I	I	SPI clock
28	MISO	I/O	Z	SPI data output pin (Master In Slave Out), or GPIO (in SPI 3-pin mode). Tri-states when SPI 3PIN = 0 and SS is deasserted
27	MOSI	I/O	I	SPI data input pin (Master Out Slave In), or SDAT
24	SS	I	I	SPI enable, active LOW assertion. Enables and frames transfers
26	IRQ	I/O	O	Interrupt output (configurable active HIGH or LOW), or GPIO
34	RST	I	I	Device reset. Internal 10 kohm pull down resistor. Active HIGH, typically connect through a 0.47 μF capacitor to V <sub>BAT</sub> . Must have RST = 1 event the first time power is applied to the radio. Otherwise the state of the radio control registers is unknown
37	L/D	O		PMU inductor/diode connection, when used. If not used, connect to GND
40	V <sub>REG</sub>	Pwr		PMU boosted output voltage feedback
35	V <sub>DD</sub>	Pwr		Decoupling pin for 1.8V logic regulator, connect through a 0.47 μF capacitor to GND
6, 8, 38	V <sub>BAT</sub>	Pwr		V <sub>BAT</sub> = 1.8V to 3.6V. Main supply
3, 7, 16	V <sub>CC</sub>	Pwr		V <sub>CC</sub> = 2.4V to 3.6V. Typically connected to V <sub>REG</sub>
33	V <sub>IO</sub>	Pwr		I/O interface voltage, 1.8–3.6V
19	RESV	I		Must be connected to GND
2, 4, 5, 9, 14, 15, 18, 17, 20, 21, 22, 23, 32, 36, 39, 31	NC	NC		Connect to GND
12	GND	GND		Ground
E-PAD	GND	GND		Ground

Figure 1. CYRF6936, 40 QFN – Top View

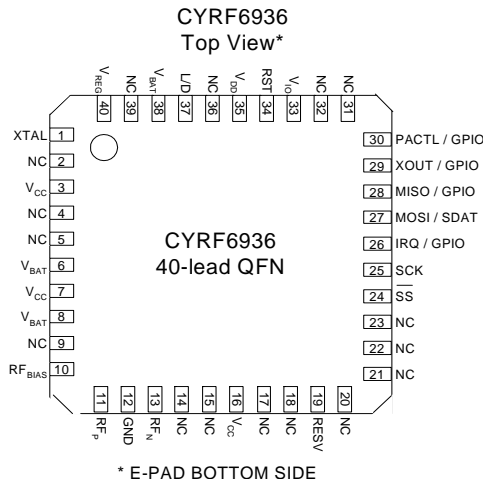

## Functional Overview

The CYRF6936 IC provides a complete WirelessUSB SPI to antenna wireless MODEMs. The SoC is designed to implement wireless device links operating in the worldwide 2.4 GHz ISM frequency band. It is intended for systems compliant with worldwide regulations covered by ETSI EN 301 489-1 V1.41, ETSI EN 300 328-1 V1.3.1 (Europe), FCC CFR 47 Part 15 (USA and Industry Canada) and TELEC ARIB\_T66\_March, 2003 (Japan).

The SoC contains a 2.4 GHz, 1 Mbps GFSK radio transceiver, packet data buffering, packet framer, DSSS baseband controller, Received Signal Strength Indication (RSSI), and SPI interface for data transfer and device configuration.

The radio supports 98 discrete 1 MHz channels (regulations may limit the use of some of these channels in certain jurisdictions).

The baseband performs DSSS spreading/despreading, Start of Packet (SOP), End of Packet (EOP) detection, and CRC16 generation and checking. The baseband may also be configured to automatically transmit Acknowledge (ACK) handshake packets whenever a valid packet is received.

When in receive mode, with packet framing enabled, the device is always ready to receive data transmitted at any of the supported bit rates, enabling the implementation of mixed-rate systems in which different devices use different data rates. This also enables the implementation of dynamic data rate systems that use high data rates at shorter distances or in a low-moderate interference environment or both, and change to lower data rates at longer distances or in high interference environments or both.

In addition, the CYRF6936 IC has a Power Management Unit (PMU), which allows direct connection of the device to any battery voltage in the range 1.8V to 3.6V. The PMU conditions the battery voltage to provide the supply voltages required by the device, and may supply external devices.

## Data Transmission Modes

The SoC supports four different data transmission modes:

- In GFSK mode, data is transmitted at 1 Mbps, without any DSSS.
- In 8DR mode, eight bits are encoded in each derived code symbol transmitted.
- In DDR mode, two bits are encoded in each derived code symbol transmitted. (As in the CYWUSB6934 DDR mode).
- In SDR mode, one bit is encoded in each derived code symbol transmitted. (As in the CYWUSB6934 standard modes.)

Both 64 chip and 32 chip Pseudo Noise (PN) codes are supported. The four data transmission modes apply to the data after the SOP. In particular the length, data, and CRC16 are all sent in the same mode. In general, lower data rates reduce packet error rate in any given environment.

## Link Layer Modes

The CYRF6936 IC device supports the following data packet framing features:

**SOP** – Packets begin with a two-symbol Start of Packet marker. This is required in GFSK and 8DR modes, but is optional in DDR mode and is not supported in SDR mode; if framing is disabled then an SOP event is inferred whenever two successive correlations are detected. The SOP\_CODE\_ADR code used for the SOP is different from that used for the “body” of the packet, and if desired may be a different length. SOP must be configured to be the same length on both sides of the link.

**Length** – There are two options for detecting the end of a packet. If SOP is enabled, then the length field should be enabled. GFSK and 8DR must enable the length field. This is the first eight bits after the SOP symbol, and is transmitted at the payload data rate. When the length field is enabled, an End of Packet condition is inferred after reception of the number of bytes defined in the length field, plus two bytes for the CRC16 (when enabled—see the following paragraph). The alternative to using the length field is to infer an EOP condition from a configurable number of successive noncorrelations; this option is not available in GFSK mode and is only recommended when using SDR mode.

**CRC16** – The device may be configured to append a 16 bit CRC16 to each packet. The CRC16 uses the USB CRC polynomial with the added programmability of the seed. If enabled, the receiver verifies the calculated CRC16 for the payload data against the received value in the CRC16 field. The seed value for the CRC16 calculation is configurable, and the CRC16 transmitted may be calculated using either the loaded seed value or a zero seed; the received data CRC16 is checked against both the configured and zero CRC16 seeds.

CRC16 detects the following errors:

- Any one bit in error
- Any two bits in error (no matter how far apart, which column, and so on)
- Any odd number of bits in error (no matter where they are)
- An error burst as wide as the checksum itself

Figure 2 shows an example packet with SOP, CRC16 and lengths fields enabled, and Figure 3 on page 4 shows a standard ACK packet.

Figure 2. Example Packet Format

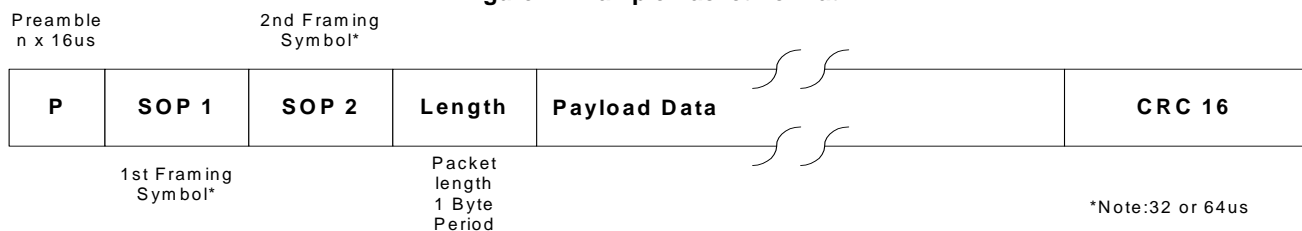
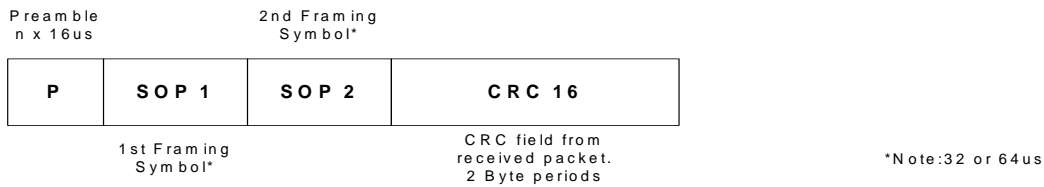

Figure 3. Example ACK Packet Format



**Packet Buffers**

All data transmission and reception uses the 16 byte packet buffers—one for transmission and one for reception.

The transmit buffer allows a complete packet of up to 16 bytes of payload data to be loaded in one burst SPI transaction, and then transmitted with no further MCU intervention. Similarly, the receive buffer allows an entire packet of payload data up to 16 bytes to be received with no firmware intervention required until packet reception is complete.

The CYRF6936 IC supports packets up to 255 bytes. However, actual maximum packet length depends on the accuracy of the clock on each end of the link and the data mode; interrupts are provided to allow an MCU to use the transmit and receive buffers as FIFOs. When transmitting a packet longer than 16 bytes, the MCU can load 16 bytes initially, and add further bytes to the transmit buffer as transmission of data creates space in the buffer. Similarly, when receiving packets longer than 16 bytes, the MCU must fetch received data from the FIFO periodically during packet reception to prevent it from overflowing.

**Auto Transaction Sequencer (ATS)**

The CYRF6936 IC provides automated support for transmission and reception of acknowledged data packets.

When transmitting in transaction mode, the device automatically:

- Starts the crystal and synthesizer
- Enters transmit mode
- Transmits the packet in the transmit buffer
- Transitions to receive mode and waits for an ACK packet
- Transitions to the transaction end state when either an ACK packet is received, or a timeout period expires

Similarly, when receiving in transaction mode, the device automatically:

- Waits in receive mode for a valid packet to be received
- Transitions to transmit mode, transmits an ACK packet
- Transitions to the transaction end state (receive mode to await the next packet, and so on.)

The contents of the packet buffers are not affected by the transmission or reception of ACK packets.

In each case, the entire packet transaction takes place without any need for MCU firmware action (as long as packets of 16 bytes or less are used); to transmit data the MCU simply must load the data packet to be transmitted, set the length, and set the TX GO bit. Similarly, when receiving packets in transaction mode, firmware simply must retrieve the fully received packet

in response to an interrupt request indicating reception of a packet.

**Backward Compatibility**

The CYRF6936 IC is fully interoperable with the main modes of the first generation devices. The 62.5 kbps mode is supported by selecting 32 chip DDR mode. Similarly, the 15.675 kbps mode is supported by selecting 64 chip SDR mode.

In this way, a suitably configured CYRF6936 IC device may transmit data to or receive data from a first generation device, or both. Backwards compatibility requires disabling the SOP, length, and CRC16 fields.

**Data Rates**

By combining the PN code lengths and data transmission modes described previously, the CYRF6936 IC supports the following data rates:

- 1000 kbps (GFSK)
- 250 kbps (32 chip 8DR)
- 125 kbps (64 chip 8DR)
- 62.5 kbps (32 chip DDR)
- 31.25 kbps (64 chip DDR)
- 15.625 kbps (64 chip SDR)

**Functional Block Overview**

**2.4 GHz Radio**

The radio transceiver is a dual conversion low IF architecture optimized for power and range/robustness. The radio employs channel-matched filters to achieve high performance in the presence of interference. An integrated Power Amplifier (PA) provides up to +4 dBm transmit power, with an output power control range of 34 dB in seven steps. The supply current of the device is reduced as the RF output power is reduced.

Table 1. Internal PA Output Power Step Table

PA Setting	Typical Output Power (dBm)
7	+4
6	0
5	-5
4	-13
3	-18
2	-24
1	-30
0	-35

**Table 2. Typical Range Observed Table**

Environment	Typical Range (meters)
Outdoor	30
Office	20
Home	15

Note: Range observed with CY4636 WirelessUSB LP KBM v1.0 (Keyboard)

**Frequency Synthesizer**

Before transmission or reception may begin, the frequency synthesizer must settle. The settling time varies depending on channel; 25 fast channels are provided with a maximum settling time of 100  $\mu$ s.

The ‘fast channels’ (less than 100  $\mu$ s settling time) are every third channel, starting at 0 up to and including 72 (for example, 0, 3, 6, 9...69, 72).

**Baseband and Framer**

The baseband and framer blocks provide the DSSS encoding and decoding, SOP generation and reception and CRC16 generation and checking, as well as EOP detection and length field.

**Packet Buffers and Radio Configuration Registers**

Packet data and configuration registers are accessed through the SPI interface. All configuration registers are directly addressed through the address field in the SPI packet (as in the CYWUSB6934). Configuration registers allow configuration of DSSS PN codes, data rate, operating mode, interrupt masks, interrupt status, and so on.

**SPI Interface**

The CYRF6936 IC has an SPI interface supporting communications between an application MCU and one or more slave devices (including the CYRF6936). The SPI interface supports single-byte and multi-byte serial transfers using either 4-pin or 3-pin interfacing. The SPI communications interface consists of Slave Select (SS), Serial Clock (SCK), and Master Out-Slave In (MOSI), Master In-Slave Out (MISO), or Serial Data (SDAT).

The SPI communications are as follows:

- Command Direction (bit 7) = ‘1’ enables SPI write transaction. A ‘0’ enables SPI read transactions.
- Command Increment (bit 6) = ‘1’ enables SPI auto address increment. When set, the address field automatically increments at the end of each data byte in a burst access, otherwise the same address is accessed.

- Six bits of address.
- Eight bits of data.

The device receives SCK from an application MCU on the SCK pin. Data from the application MCU is shifted in on the MOSI pin. Data to the application MCU is shifted out on the MISO pin. The active LOW Slave Select (SS) pin must be asserted to initiate an SPI transfer.

The application MCU can initiate SPI data transfers using a multi-byte transaction. The first byte is the Command/Address byte, and the following bytes are the data bytes as shown in Figure 4 through Figure 6 on page 6.

The SPI communications interface has a burst mechanism, where the first byte can be followed by as many data bytes as desired. A burst transaction is terminated by deasserting the slave select (SS = 1).

The SPI communications interface single read and burst read sequences are shown in Figure 5 and Figure 6, respectively.

The SPI communications interface single write and burst write sequences are shown in Figure 7 and Figure 8, respectively.

This interface may optionally be operated in a 3-pin mode with the MISO and MOSI functions combined in a single bidirectional data pin (SDAT). When using 3-pin mode, user firmware should ensure that the MOSI pin on the MCU is in a high impedance state except when MOSI is actively transmitting data.

The device registers may be written to or read from one byte at a time, or several sequential register locations may be written/read in a single SPI transaction using incrementing burst mode. In addition to single byte configuration registers, the device includes register files; register files are FIFOs written to and read from using nonincrementing burst SPI transactions.

The IRQ pin function may optionally be multiplexed onto the MOSI pin; when this option is enabled the IRQ function is not available while the SS pin is LOW. When using this configuration, user firmware should ensure that the MOSI pin on the MCU is in a high impedance state whenever the SS pin is HIGH.

The SPI interface is not dependent on the internal 12 MHz clock. Registers may therefore be read from or written to while the device is in sleep mode, and the 12 MHz oscillator disabled.

The SPI interface and the IRQ and RST pins have a separate voltage reference pin (V<sub>IO</sub>), enabling the device to interface directly to MCUs operating at voltages below the CYRF6936 IC supply voltage.

Figure 4. SPI Transaction Format

	Byte 1			Byte 1+N
Bit #	7	6	[5:0]	[7:0]
Bit Name	DIR	INC	Address	Data

Figure 5. SPI Single Read Sequence

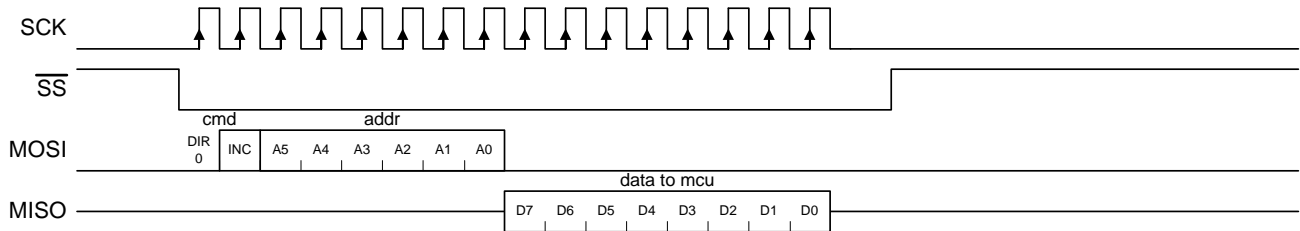

Figure 6. SPI Incrementing Burst Read Sequence

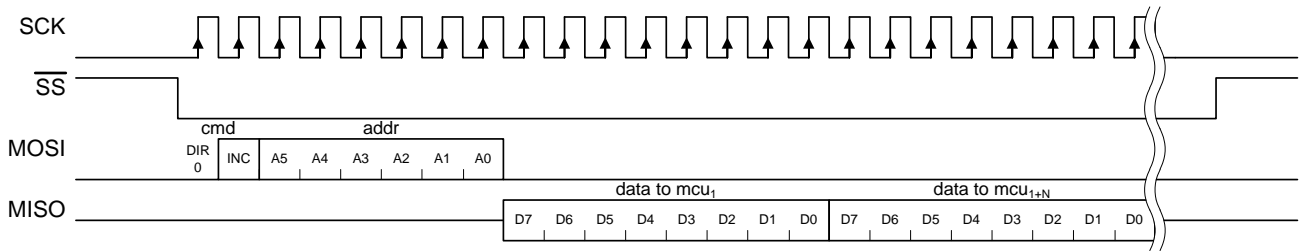

Figure 7. SPI Single Write Sequence

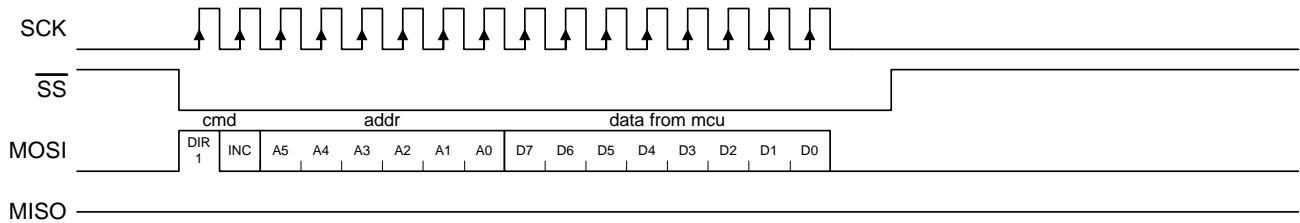
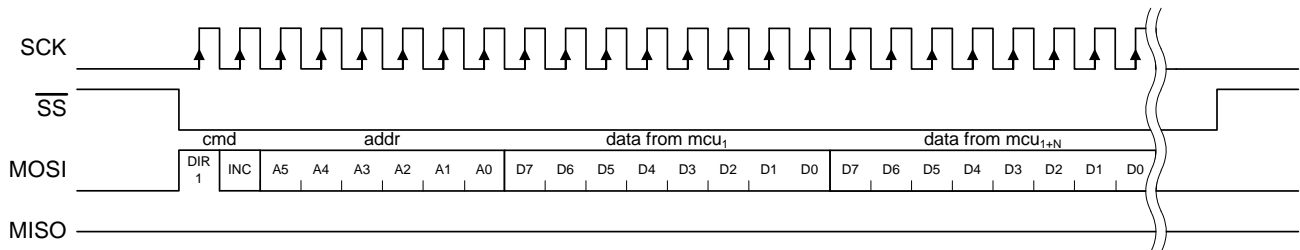

Figure 8. SPI Incrementing Burst Write Sequence



## Interrupts

The device provides an interrupt (IRQ) output, which is configurable to indicate the occurrence of various different events. The IRQ pin may be programmed to be either active HIGH or active LOW, and be either a CMOS or open drain output. A full description of all the available interrupts can be found in “Register Descriptions” on page 12.

The CYRF6936 IC features three sets of interrupts: transmit, receive, and system interrupts. These interrupts all share a single pin (IRQ), but can be independently enabled/disabled. The contents of the enable registers are preserved when switching between transmit and receive modes.

If more than one interrupt is enabled at any time, it is necessary to read the relevant status register to determine which event caused the IRQ pin to assert. Even when a given interrupt source is disabled, the status of the condition that would otherwise cause an interrupt can be determined by reading the appropriate status register. It is therefore possible to use the devices without the IRQ pin by polling the status registers to wait for an event, rather than using the IRQ pin.

## Clocks

A 12 MHz crystal (30 ppm or better) is directly connected between XTAL and GND without the need for external capacitors. A digital clock out function is provided, with selectable output frequencies of 0.75, 1.5, 3, 6, or 12 MHz. This output may be used to clock an external microcontroller (MCU) or ASIC. This output is enabled by default, but may be disabled.

Listed below are the requirements for the crystal to be directly connected to XTAL pin and GND.

- Nominal Frequency: 12 MHz
- Operating Mode: Fundamental Mode
- Resonance Mode: Parallel Resonant
- Frequency Initial Stability:  $\pm 30$  ppm
- Series Resistance:  $\leq 60$  ohms
- Load Capacitance: 10 pF
- Drive Level: 10  $\mu$ W–100  $\mu$ W

## Power Management

The operating voltage of the device is 1.8V to 3.6V DC, which is applied to the  $V_{BAT}$  pin. The device can be shut down to a fully static sleep mode by writing to the  $FRC\_END = 1$  and  $END\_STATE = 000$  bits in the  $XACT\_CFG\_ADR$  register over the SPI interface. The device enters sleep mode within 35  $\mu$ s after the last SCK positive edge at the end of this SPI transaction. Alternatively, the device may be configured to automatically enter sleep mode after completing packet transmission or reception. When in sleep mode, the on-chip oscillator is stopped, but the SPI interface remains functional. The device wakes from sleep mode automatically when the device is

commanded to enter transmit or receive mode. When resuming from sleep mode, there is a short delay while the oscillator restarts. The device can be configured to assert the IRQ pin when the oscillator has stabilized.

The output voltage ( $V_{REG}$ ) of the Power Management Unit (PMU) is configurable to several minimum values between 2.4V and 2.7V.  $V_{REG}$  may be used to provide up to 15 mA (average load) to external devices. It is possible to disable the PMU, and to provide an externally regulated DC supply voltage to the device’s main supply in the range 2.4V to 3.6V. The PMU also provides a regulated 1.8V supply to the logic.

The PMU is designed to provide high boost efficiency (74–85% depending on input voltage, output voltage and load) when using a Schottky diode and power inductor, eliminating the need for an external boost converter in many systems where other components require a boosted voltage. However, reasonable efficiencies (69–82% depending on input voltage, output voltage, and load) may be achieved when using low cost components such as SOT23 diodes and 0805 inductors.

The PMU also provides a configurable low battery detection function, which may be read over the SPI interface. One of seven thresholds between 1.8V and 2.7V may be selected. The interrupt pin may be configured to assert when the voltage on the  $V_{BAT}$  pin falls below the configured threshold. LV IRQ is not a latched event. Battery monitoring is disabled when the device is in sleep mode.

## Low Noise Amplifier and Received Signal Strength Indication

The gain of the receiver can be controlled directly by clearing the AGC EN bit and writing to the Low Noise Amplifier (LNA) bit of the  $RX\_CFG\_ADR$  register. Clearing the LNA bit reduces the receiver gain approximately 20 dB, allowing accurate reception of very strong received signals (for example when operating a receiver very close to the transmitter). Approximately 30 dB of receiver attenuation can be added by setting the Attenuation (ATT) bit; this allows data reception to be limited to devices at very short ranges. Disabling AGC and enabling LNA is recommended unless receiving from a device using external PA.

When the device is in receive mode the  $RSSI\_ADR$  register returns the relative signal strength of the on-channel signal power.

When receiving, the device automatically measures and stores the relative strength of the signal being received as a five bit value. An RSSI reading is taken automatically when the SOP is detected. In addition, a new RSSI reading is taken every time the previous reading is read from the  $RSSI\_ADR$  register, allowing the background RF energy level on any given channel to be easily measured when RSSI is read when no signal is being received. A new reading can occur as fast as once every 12  $\mu$ s.

Application Examples

Figure 9. Recommended Circuit for Systems Where V<sub>BAT</sub> May Fall Below 2.4V

The power supply decoupling shown for VBATO is a recommended cost effective configuration: R2=10hm C7=10uF ceramic. C6=No Load For this configuration, it is required that C18 be installed.

An alternate decoupling configuration is the following: R2=0ohm C7=.047uF. For this configuration, it is not required to load C18.

For reference design part numbers, please refer to the Bill of Materials file 121-26504\_A.XLS.

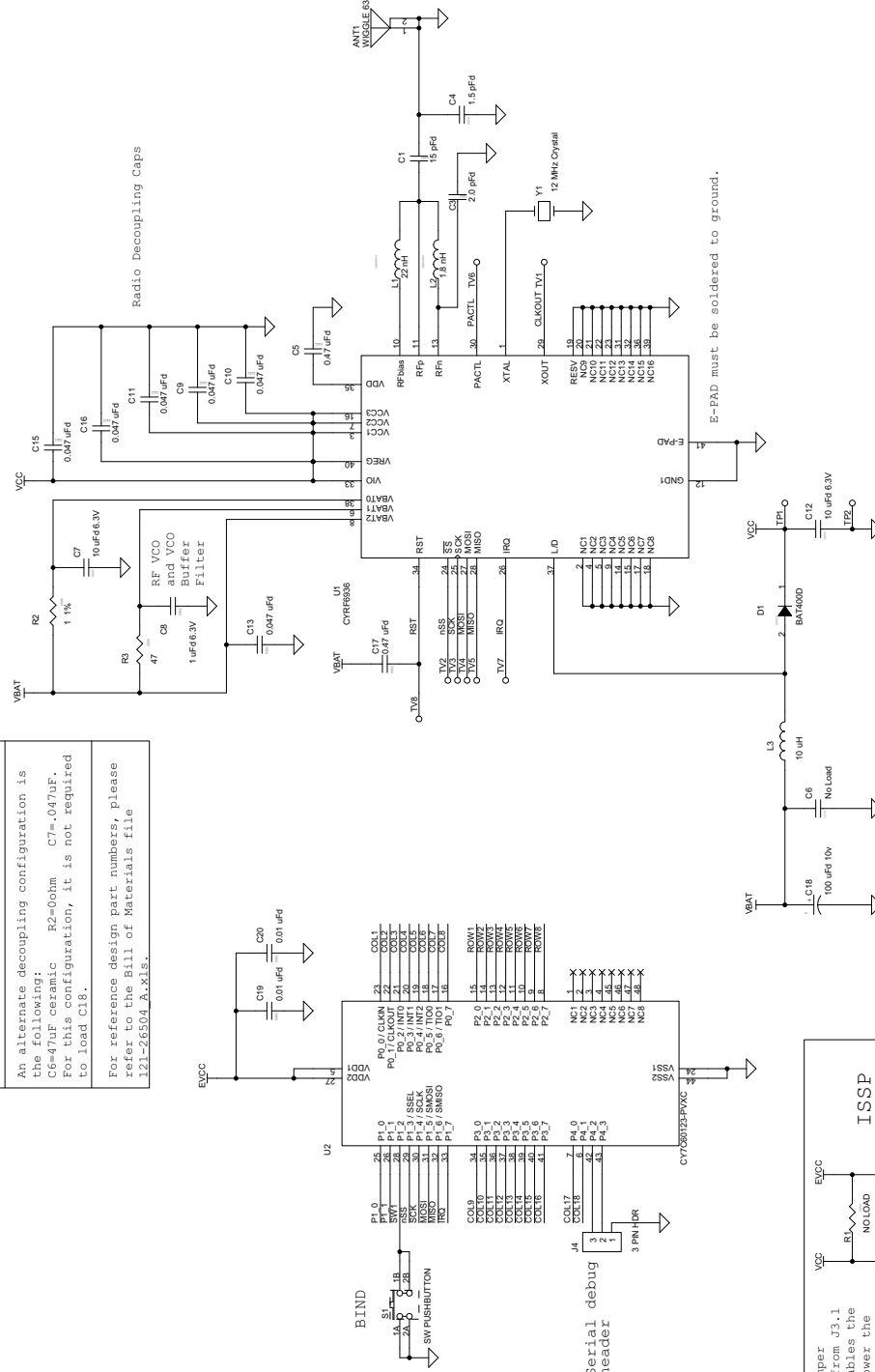

A 2-pin jumper installed from J3.1 to J2.1 enables the radio to power the processor. Jumper removal is required when programming U2 to disconnect the radio from the Miniprogram source.

R1 is a zero ohm resistor that should be installed for production units only, following programming.

Layout J3 and J2.1 in a 0.100" spacing configuration



**Table 3. Recommended Bill of Materials for Systems Where  $V_{BAT}$  May Fall Below 2.4V**

Item	Qty	CY Part Number	Reference	Description	Manufacturer	Mfr Part Number
1	1	NA	ANT1	2.5GHZ H-STUB WIGGLE ANTEN-NA FOR 63MIL PCB	NA	NA
2	1	730-10012	C1	CAP 15PF 50V CERAMIC NPO 0402	Panasonic	ECJ-0EC1H150J
3	1	730-11955	C3	CAP 2.0 PF 50V CERAMIC NPO 0402	Kemet	C0402C209C5GACTU
4	1	730-11398	C4	CAP 1.5PF 50V CERAMIC NPO 0402 SMD	PANASONIC	ECJ-0EC1H1R5C
5	2	730R-13322	C5,C17	CAP CER 0.47UF 6.3V X5R 0402	Murata	GRM155R60J474KE19D
6	2	730-13037	C12,C7	CAP CERAMIC 10UF 6.3V X5R 0805	Kemet	C0805C106K9PACTU
7	1	730-13400	C8	CAP 1 uF 6.3V CERAMIC X5R 0402	Panasonic	ECJ-0EB0J105M
8	6	730-13404	C9,C10,C11,C13,C15,C16	CAP 0.047 uF 50V CERAMIC X5R 0402	AVX	0402YD473KAT2A
9	1	730-11952	C19	CAP 0.1 uF 50V CERAMIC X5R 0402	Kemet	C0402C104K8PACTU
10	1	710-13201	C18	CAP 100UF 10V ELECT FC	Panasonic - ECG	EEU-FC1A101S
11	4	730-10794	C20,C23,C24,C25	CAP 10000PF 16V CERAMIC 0402 SMD	Panasonic - ECG	ECJ-0EB1C103K
12	3	730-13036	C26,C27,C28	CAP CERAMIC 1.0UF 10V X5R 0603	Kemet	C0603C105K8PACTU
13	1	800-13248	D1	DIODE SCHOTTKY 20V 1A SMA	Taiwan Semiconductor	SS12
14	1	420-11964	J1	HEADER 1 POS 0.230 HT MODII 0.100CL	AMP/Tyco	103185-1
15	1	420-11496	J3	CONN HDR BRKWAY 5POS STR AU PCB	AMP Division of TYCO	103185-5
16	1	800-13401	L1	INDUCTOR 22NH 2% FIXED 0603 SMD	Panasonic - ECG	ELJ-RE22NGF2
17	1	800-11651	L2	INDUCTOR 1.8NH +/- .3NH FIXED 0402 SMD	Panasonic - ECG	ELJ-RF1N8DF
18	1	800-13253	L3	COIL 10UH 1.23A UNSHIELDED SMD	Sumida	CDH53100LC
19	1	610-13402	R1	RES 47 OHM 1/16W 5% 0402 SMD	Panasonic - ECG	ERJ-2GEJ470X
20	1	620-10539	R2	RES 100K OHM 1/16W 5% 0603 SMD	Panasonic - ECG	ERJ-3GEYJ104V
21	3	tmp	R6,R7,R8	RES CHIP 5.11 OHM 1/16W 1% 0603 SMD	Yageo America	9C06031A5R11FGHFT
22	1	630-11356	R9	RES 1.00 OHM 1/8W 1% 0805 SMD	Yageo	9C08052A1R00FKHFT
23	1	CYRF6936-40LFC	U1	IC, LP 2.4 GHz RADIO SoC QFN-40	Cypress Semiconductor	CYRF6936 Rev A5
24	1	CY7C60323-PVXC	U2	IC WIRELESS MICROCONTROLLER SSOP28	Cypress Semiconductor	CY7C60323-PVXC
25	1	800-13259	Y1	CRYSTAL 12.00MHZ HC49 SMD	eCERA	GF-1200008
26	1	PDC-9302-*C	PCB	PRINTED CIRCUIT BOARD	Cypress Semiconductor	PDC-9302-*C
27	1	920-11206	LABEL1	Serial Number		
28	1	920-30200 *C	LABEL2	PCA #		121-30200 *C

Figure 10. Recommended Circuit for Systems Where V<sub>BAT</sub> is 2.4V to 3.6V (PMU disabled)

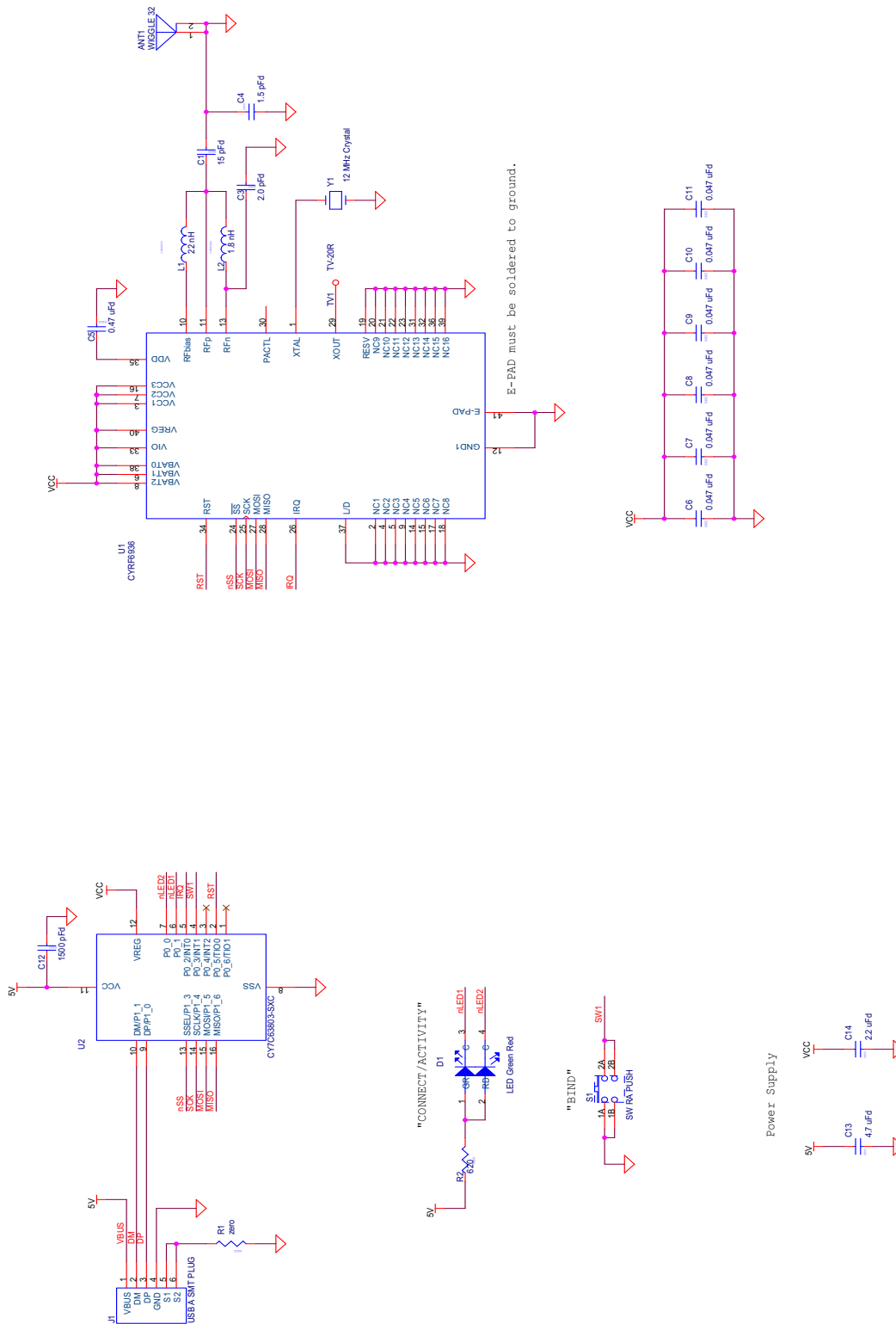

**Table 4. Recommended Bill of Materials for Systems Where  $V_{BAT}$  is 2.4V to 3.6V (PMU disabled)**

Item	Qty	CY Part Number	Reference	Description	Manufacturer	Mfr Part Number
1	1	NA	ANT1	2.5GHZ H-STUB WIGGLE ANTEN-NA FOR 32MIL PCB	NA	NA
2	1	730-10012	C1	CAP 15PF 50V CERAMIC NPO 0402	Panasonic	ECJ-0EC1H150J
3	1	730-11955	C3	CAP 2.0 PF 50V CERAMIC NPO 0402	Kemet	C0402C209C5GACTU
4	1	730-11398	C4	CAP 1.5PF 50V CERAMIC NPO 0402 SMD	PANASONIC	ECJ-0EC1H1R5C
5	1	730-13322	C5	CAP 0.47 uF 6.3V CERAMIC X5R 0402	Murata	GRM155R60J474KE19D
6	6	730-13404	C6,C7,C8,C9,C10,C11	CAP 0.047 uF 16V CERAMIC X5R 0402	AVX	0402YD473KAT2A
7	1	730-11953	C12	CAP 1500PF 50V CERAMIC X7R 0402	Kemet	C0402C152K5RACTU
8	1	730-13040	C13	CAP CERAMIC 4.7UF 6.3V XR5 0805	Kemet	C0805C475K9PACTU
9	1	730-12003	C14	CAP CER 2.2UF 10V 10% X7R 0805	Murata Electronics North America	GRM21BR71A225KA01L
10	1	800-13333	D1	LED GREEN/RED BICOLOR 1210 SMD	LITEON	LTST-C155KGJRKT
11	1	420-13046	J1	CONN USB PLUG TYPE A PCB SMT	ACON	UAR72-4N5J10
12	1	800-13401	L1	INDUCTOR 22NH 2% FIXED 0603 SMD	Panasonic - ECG	ELJ-RE22NGF2
13	1	800-11651	L2	INDUCTOR 1.8NH +/- .3NH FIXED 0402 SMD	Panasonic - ECG	ELJ-RF1N8DF
14	1	610-10343	R1	RES ZERO OHM 1/16W 0402 SMD	Panasonic - ECG	ERJ-2GE0R00X
15	1	610-13472	R2	RES CHIP 620 OHM 1/16W 5% 0402 SMD	Panasonic - ECG	ERJ-2GEJ621X
16	1	200-13471	S1	SWITCH LT 3.5MMX2.9MM 160GF SMD	Panasonic - ECG	EVQ-P7J01K
17	1	CYRF6936-40LFC	U1	IC, LP 2.4 GHz RADIO SoC QFN-40	Cypress Semiconductor	CYRF6936 Rev A5
18	1	CY7C63803-SXC	U2	IC LOW-SPEED USB ENCORE II CONTROLLER SOIC16	Cypress Semiconductor	CY7C63803-SXC
19	1	800-13259	Y1	CRYSTAL 12.00MHZ HC49 SMD	eCERA	GF-1200008
20	1	PDC-9263-*B	PCB	PRINTED CIRCUIT BOARD	Cypress Semiconductor	PDC-9263-*B
21	1		LABEL1	Serial Number	XXXXXX	
22	1		LABEL2	PCA #	121-26305 **	

## Register Descriptions

All registers are read and writable, except where noted. Registers may be written to or read from either individually or in sequential groups.

**Table 5. Register Map Summary**

Address	Mnemonic	b7	b6	b5	b4	b3	b2	b1	b0	Default <sup>(1)</sup>	Access <sup>(1)</sup>	
0x00	CHANNEL_ADR	Not Used	Channel								-1001000	-bbbbbbb
0x01	TX_LENGTH_ADR	TX Length								00000000	bbbbbbbb	
0x02	TX_CTRL_ADR	TX GO	TX CLR	TXB15 IRQEN	TXB8 IRQEN	TXB0 IRQEN	TXBERR IRQEN	TXC IRQEN	TXE IRQEN	00000011	bbbbbbbb	
0x03	TX_CFG_ADR	Not Used	Not Used	DATA CODE LENGTH	DATA MODE		PA SETTING			--000101	--bbbbbb	
0x04	TX_IRQ_STATUS_ADR	OS IRQ	LV IRQ	TXB15 IRQ	TXB8 IRQ	TXB0 IRQ	TXBERR IRQ	TXC IRQ	TXE IRQ	-----	rrrrrrrr	
0x05	RX_CTRL_ADR	RX GO	RSVD	RXB16 IRQEN	RXB8 IRQEN	RXB0 IRQEN	RXBERR IRQEN	RXC IRQEN	RXE IRQEN	00000111	bbbbbbbb	
0x06	RX_CFG_ADR	AGC EN	LNA	ATT	HILO	FAST TURN EN	Not Used	RXOW EN	VLD EN	10010-10	bbbb-bb	
0x07	RX_IRQ_STATUS_ADR	RXOW IRQ	SOPDET IRQ	RXB16 IRQ	RXB8 IRQ	RXB0 IRQ	RXBERR IRQ	RXC IRQ	RXE IRQ	-----	brrrrrrr	
0x08	RX_STATUS_ADR	RX ACK	PKT ERR	EOP ERR	CRC0	Bad CRC	RX Code	RX Data Mode		-----	rrrrrrrr	
0x09	RX_COUNT_ADR	RX Count								00000000	rrrrrrrr	
0x0A	RX_LENGTH_ADR	RX Length								00000000	rrrrrrrr	
0x0B	PWR_CTRL_ADR	PMU EN	LVIRQ EN	PMU Mode Force	Not Used	LVI TH		PMU OUTV		10100000	bbb-bbbb	
0x0C	XTAL_CTRL_ADR	XOUT FN		XSIRQ EN	Not Used	Not Used	FREQ			00--100	bbb-bbb	
0x0D	IO_CFG_ADR	IRQ OD	IRQ POL	MISO OD	XOUT OD	PACTL OD	PACTL GPIO	SPI 3PIN	IRQ GPIO	00000000	bbbbbbbb	
0x0E	GPIO_CTRL_ADR	XOUT OP	MISO OP	PACTL OP	IRQ OP	XOUT IP	MISO IP	PACTL IP	IRQ IP	0000----	bbbbrrrr	
0x0F	XACT_CFG_ADR	ACK EN	Not Used	FRC END	END STATE		ACK TO			1-000000	b-bbbbbbb	
0x10	FRAMING_CFG_ADR	SOP EN	SOP LEN	LEN EN	SOP TH					10100101	bbbbbbbb	
0x11	DATA32_THOLD_ADR	Not Used	Not Used	Not Used	Not Used	TH32					----0100	----bbbb
0x12	DATA64_THOLD_ADR	Not Used	Not Used	Not Used	TH64					---01010	---bbbbbb	
0x13	RSSI_ADR	SOP	Not Used	LNA	RSSI					0-100000	r-rrrrrr	
0x14	EOP_CTRL_ADR	HEN	HINT			EOP					10100100	bbbbbbbb
0x15	CRC_SEED_LSB_ADR	CRC SEED LSB								00000000	bbbbbbbb	
0x16	CRC_SEED_MSB_ADR	CRC SEED MSB								00000000	bbbbbbbb	
0x17	TX_CRC_LSB_ADR	CRC LSB								-----	rrrrrrrr	
0x18	TX_CRC_MSB_ADR	CRC MSB								-----	rrrrrrrr	
0x19	RX_CRC_LSB_ADR	CRC LSB								11111111	rrrrrrrr	
0x1A	RX_CRC_MSB_ADR	CRC MSB								11111111	rrrrrrrr	
0x1B	TX_OFFSET_LSB_ADR	STRIM LSB								00000000	bbbbbbbb	
0x1C	TX_OFFSET_MSB_ADR	Not Used	Not Used	Not Used	Not Used	STRIM MSB					----0000	----bbbb
0x1D	MODE_OVERRIDE_ADR	RSVD	RSVD	FRC SEN	FRC AWAKE		Not Used	Not Used	RST	0000--0	wwwww--w	
0x1E	RX_OVERRIDE_ADR	ACK RX	RXTX DLY	MAN RXACK	FRC RXDR	DIS CRC0	DIS RXCRC	ACE	Not Used	0000000-	bbbbbbbb-	
0x1F	TX_OVERRIDE_ADR	ACK TX	FRC PRE	RSVD	MAN TXACK	OVRD ACK	DIS TXCRC	RSVD	TX INV	00000000	bbbbbbbb	
0x26	XTAL_CFG_ADR	RSVD	RSVD	RSVD	RSVD	START DLY	RSVD	RSVD	RSVD	00000000	wwwwwww w	
0x27	CLK_OVERRIDE_ADR	RSVD	RSVD	RSVD	RSVD	RSVD	RSVD	RXF	RSVD	00000000	wwwwwww w	
0x28	CLK_EN_ADR	RSVD	RSVD	RSVD	RSVD	RSVD	RSVD	RXF	RSVD	00000000	wwwwwww w	
0x29	RX_ABORT_ADR	RSVD	RSVD	ABORT EN	RSVD	RSVD	RSVD	RSVD	RSVD	00000000	wwwwwww w	
0x32	AUTO_CAL_TIME_ADR	AUTO_CAL_TIME								00000011	wwwwwww w	
0x35	AUTO_CAL_OFFSET_ADR	AUTO_CAL_OFFSET								00000000	wwwwwww w	
0x39	ANALOG_CTRL_ADR	RSVD	RSVD	RSVD	RSVD	RSVD	RSVD	RX INV	ALL SLOW	00000000	wwwwwww w	
Register Files												
0x20	TX_BUFFER_ADR	TX Buffer File								-----	wwwwwww w	
0x21	RX_BUFFER_ADR	RX Buffer File								-----	rrrrrrrr	
0x22	SOP_CODE_ADR	SOP Code File								Note 2	bbbbbbbb	
0x23	DATA_CODE_ADR	Data Code File								Note 3	bbbbbbbb	
0x24	PREAMBLE_ADR	Preamble File								Note 4	bbbbbbbb	
0x25	MFG_ID_ADR	MFG ID File								NA	rrrrrrrr	

**Notes**

1. b = read/write; r = read only; w = write only; '-' = not used, default value is undefined.
2. SOP\_CODE\_ADR default = 0x17FF9E213690C782.
3. DATA\_CODE\_ADR default = 0x02F9939702FA5CE3012BF1DB0132BE6F.
4. PREAMBLE\_ADR default = 0x333302.

Mnemonic	CHANNEL_ADR						Address	0x00
Bit	7	6	5	4	3	2	1	0
Default	-	1	0	0	1	0	0	0
Read/Write	-	R/W	R/W	R/W	R/W	R/W	R/W	R/W
Function	Not Used Channel							
Bit 7	Not Used.							
Bits 6:0	This field selects the channel. 0x00 sets 2400 MHz; 0x62 sets 2498 MHz. Values above 0x62 are not valid. The default channel is a fast channel above the frequency typically used in non-overlapping WiFi systems. Any write to this register impacts the time it takes the synthesizer to settle.							
	fast (100 μs) - 0 3 6 9 12 15 18 21 24 27 30 33 36 39 42 45 48 51 54 57 60 63 66 69 72 96							
	medium (180 μs) - 2 4 8 10 14 16 20 22 26 28 32 34 38 40 44 46 50 52 56 58 62 64 68 70 74 76 78 80 82 84 86 88 90 92 94							
	slow (270 μs) - 1 5 7 11 13 17 19 23 25 29 31 35 35 37 41 43 47 49 53 55 59 61 65 67 71 73 75 77 79 81 83 85 87 89 91 93 95 97							
	Usable channels subject to regulation.							
	Do not access or modify this register during Transmit or Receive.							

Mnemonic	TX_LENGTH_ADR						Address	0x01
Bit	7	6	5	4	3	2	1	0
Default	0	0	0	0	0	0	0	0
Read/Write	R/W	R/W	R/W	R/W	R/W	R/W	R/W	R/W
Function	TX Length							
Bits 7:0	This register sets the length of the packet to be transmitted. A length of zero is valid, and transmits a packet with SOP, length and CRC16 fields (if enabled), but no data field. Packet lengths of more than 16 bytes require that some data bytes be written after transmission of the packet has begun. Typically, length is updated prior to setting TX GO. The maximum packet length for all packets is 40 bytes except for framed 64 chip DDR where the maximum packet length is 16 bytes.							
	Maximum packet length is limited by the delta between the transmitter and receiver crystals of 60 ppm or better.							

Mnemonic	TX_CTRL_ADR						Address	0x02
Bit	7	6	5	4	3	2	1	0
Default	0	0	0	0	0	0	1	1
Read/Write	R/W	R/W	R/W	R/W	R/W	R/W	R/W	R/W
Function	TX GO	TX CLR	TXB15 IRQEN	TXB8 IRQEN	TXB0 IRQEN	TXBERR IRQEN	TXC IRQEN	TXE IRQEN
Bit 7	Start Transmission. Setting this bit triggers the transmission of a packet. Writing '0' to this flag has no effect. This bit is cleared automatically at the end of packet transmission. The transmit buffer may be loaded either before or after setting this bit. If data is loaded after setting this bit, the length of time available to load the buffer depends on the starting state (sleep, idle or synth), the length of the SOP code, the length of preamble, and the packet data rate. For example, if starting from idle mode on a fast channel in 8DR mode with 32 chip SOP codes the time available is 100 μs (synth start) + 32 μs (preamble) + 64 μs (SOP length) + 32 μs (length byte) = 228 μs. If there are no bytes in the TX buffer at the end of transmission of the length field, a TXBERR IRQ occurs.							
Bit 6	Clear TX Buffer. Writing '1' to this register clears the transmit buffer. Writing '0' to this bit has no effect. The previous packet (16 or fewer bytes) may be retransmitted by setting TX GO and not setting this bit.							
Bit 5	Buffer Not Full Interrupt Enable. See TX_IRQ_STATUS_ADR for description.							
Bit 4	Buffer Half Empty Interrupt Enable. See TX_IRQ_STATUS_ADR for description.							
Bit 3	Buffer Empty Interrupt Enable. See TX_IRQ_STATUS_ADR for description.							
Bit 2	Buffer Error Interrupt Enable. See TX_IRQ_STATUS_ADR for description.							
Bit 1	Transmission Complete Interrupt Enable. TXC IRQEN and TXE IRQEN must be set together. See TX_IRQ_STATUS_ADR for description.							
Bit 0	Transmit Error Interrupt Enable. TXC IRQEN and TXE IRQEN must be set together. See TX_IRQ_STATUS_ADR for description.							

Mnemonic	TX_CFG_ADR			Address				0x03
	7	6	5	4	3	2	1	
Bit	7	6	5	4	3	2	1	0
Default	-	-	0	0	0	1	0	1
Read/Write	-	-	R/W	R/W	R/W	R/W	R/W	R/W
Function	Not Used	Not Used	Data Code Length	Data Mode		PA Setting		
Bit 5	Data Code Length. This bit selects the length of the DATA_CODE_ADR code for the data portion of the packet. This bit is ignored when the data mode is set to GFSK. 1 = 64 chip codes. 0 = 32 chip codes.							
Bits 4:3	Data Mode. This field sets the data transmission mode. 00 = 1-Mbps GFSK. 01 = 8DR Mode. 10 = DDR Mode. 11 = SDR Mode. It is recommended that firmware set the ALL SLOW bit in register ANALOG_CTRL_ADR when using GFSK data rate mode.							
Bits 2:0	PA Setting. This field sets the transmit signal strength. 0 = -35 dBm, 1 = -30 dBm, 2 = -24 dBm, 3 = -18 dBm, 4 = -13 dBm, 5 = -5 dBm, 6 = 0 dBm, 7 = +4 dBm.							

Mnemonic	TX_IRQ_STATUS_ADR				Address				0x04
	7	6	5	4	3	2	1	0	
Bit	7	6	5	4	3	2	1	0	
Default	-	-	-	-	-	-	-	-	
Read/Write	R	R	R	R	R	R	R	R	
Function	OS IRQ	LV IRQ	TXB15 IRQ	TXB8 IRQ	TXB0 IRQ	TXBERR IRQ	TXC IRQ	TXE IRQ	
The state of all IRQ status bits is valid regardless of whether or not the IRQ is enabled. The IRQ output of the device is in its active state whenever one or more bits in this register is set and the corresponding IRQ enable bit is also set. Status bits are non-atomic (different flags may change value at different times in response to a single event).									
Bit 7	Oscillator Stable IRQ Status. This bit is set when the internal crystal oscillator has settled (synthesizer sequence starts).								
Bit 6	Low Voltage Interrupt Status. This bit is set when the voltage on V <sub>BAT</sub> is below the LVI threshold (see PWR_CTL_ADR). This interrupt is automatically disabled whenever the PMU is disabled. When enabled, this bit reflects the voltage on V <sub>BAT</sub> .								
Bit 5	Buffer Not Full Interrupt Status. This bit is set whenever there are 15 or fewer bytes remaining in the transmit buffer.								
Bit 4	Buffer Half Empty Interrupt Status. This bit is set whenever there are eight or fewer bytes remaining in the transmit buffer.								
Bit 3	Buffer Empty Interrupt Status. This bit is set at any time that the transmit buffer is empty.								
Bit 2	Buffer Error Interrupt Status. This IRQ is triggered by either of two events: (1) When the transmit buffer (TX_BUFFER_ADR) is empty and the number of bytes remaining to be transmitted is greater than zero. (2) When a byte is written to the transmit buffer and the buffer is already full. This IRQ is cleared by setting bit TX CLR in TX_CTRL_ADR.								
Bit 1	Transmission Complete Interrupt Status. This IRQ is triggered when transmission is complete. If transaction mode is not enabled then this interrupt is triggered immediately after transmission of the last bit of the CRC16. If transaction mode is enabled, this interrupt is triggered at the end of a transaction. Reading this register clears this bit. TXC IRQ and TXE IRQ flags may change value at different times in response to a single event. If transaction mode is enabled and the first read of this register returns TXC IRQ = 1 and TXE IRQ = 0 then firmware must execute a second read to this register to determine if an error occurred by examining the status of TXE. There can be a case when this bit is not triggered when ACK EN = 1 and there is an error in transmission. If the first read of this register returns TXC IRQ = 1 and TXE IRQ = 1, then the firmware must not execute a second read from this register for a given transaction. If an ACK is received RXC IRQ and RXE IRQ may be asserted instead of TXC IRQ and TXE IRQ.								
Bit 0	Transmit Error Interrupt Status. This IRQ is triggered when there is an error in transmission. This interrupt is only applicable to transaction mode. It is triggered whenever no valid ACK packet is received within the ACK timeout period. Reading this register clears this bit. See TXC IRQ, above.								

Mnemonic	RX_CTRL_ADR			Address			0x05	
Bit	7	6	5	4	3	2	1	0
Default	0	0	0	0	0	1	1	1
Read/Write	R/W	R/W	R/W	R/W	R/W	R/W	R/W	R/W
Function	RX GO	RSVD	RXB16 IRQEN	RXB8 IRQEN	RXB1 IRQEN	RXBERR IRQEN	RXC IRQEN	RXE IRQEN
Bit 7	Start Receive. Setting this bit causes the device to transition to receive mode. If necessary, the crystal oscillator and synthesizer start automatically after this bit is set. Firmware must never clear this bit. This bit must not be set again until after it clears. The recommended method to exit receive mode when an error has occurred is to force END STATE and then dummy read all RX_COUNT_ADR bytes from RX_BUFFER_ADR or poll RSSI_ADR.SOP (bit 7) until set. See XACT_CFG_ADR and RX_ABORT_ADR for description.							
Bit 6	Reserved. Must be zero.							
Bit 5	Buffer Full Interrupt Enable. See RX_IRQ_STATUS_ADR for description.							
Bit 4	Buffer Half Empty Interrupt Enable. See RX_IRQ_STATUS_ADR for description.							
Bit 3	Buffer Not Empty Interrupt Enable. RXB1 IRQEN must not be set when RXB8 IRQEN is set and vice versa. See RX_IRQ_STATUS_ADR for description.							
Bit 2	Buffer Error Interrupt Enable. See RX_IRQ_STATUS_ADR for description.							
Bit 1	Packet Reception Complete Interrupt Enable. See RX_IRQ_STATUS_ADR for description.							
Bit 0	Receive Error Interrupt Enable. See RX_IRQ_STATUS_ADR for description.							

Mnemonic	RX_CFG_ADR			Address			0x06	
Bit	7	6	5	4	3	2	1	0
Default	1	0	0	1	0	-	1	0
Read/Write	R/W	R/W	R/W	R/W	R/W	-	R/W	R/W
Function	AGC EN	LNA	ATT	HILO	FAST TURN EN	Not Used	RXOW EN	VLD EN

Status bits are non-atomic (different flags may change value at different times in response to a single event).

Bit 7	Automatic Gain Control (AGC) Enable. When this bit is set, AGC is enabled, and the LNA is controlled by the AGC circuit. When this bit is cleared the LNA is controlled manually using the LNA bit. Typical applications clear this bit during initialization. It is recommended that this bit be cleared and bit 6 (LNA) be set unless the device is used in a system where it may receive data from a device using an external PA to transmit signals at more than +4 dBm.
Bit 6	Low Noise Amplifier (LNA) Manual Control. When AGC EN (Bit 7) is cleared, this bit controls the state of the receiver LNA; when AGC EN is set, this bit has no effect. Setting this bit enables the LNA; clearing this bit disables the LNA. Device current in receive mode is slightly lower when the LNA is disabled. Typical applications set this bit during initialization.
Bit 5	Receive Attenuator Enable. Setting this bit enables the receiver attenuator. The receiver attenuator may be used to desensitize the receiver so that only very strong signals may be received. This bit should only be set when the AGC EN is disabled and the LNA is manually disabled.
Bit 4	HILO. When FAST TURN EN is set, this bit is used to select whether the device uses the high frequency for the channel selected, or the low frequency. 1 = hi; 0 = lo. When FAST TURN EN is not enabled this also controls the high-low bit to the receiver and should be left at the default value of '1' for high side receive injection. Typical applications clear this bit during initialization.
Bit 3	Fast Turn Mode Enable. When this bit is set, the HILO bit determines whether the device receives data transmitted 1 MHz above the RX Synthesizer frequency or 1 MHz below the receiver synthesizer frequency. Use of this mode allows for very fast turnaround, because the same synthesizer frequency may be used for both transmit and receive, thus eliminating the synthesizer resettling period between transmit and receive. Note that when this bit is set, and the HILO bit is cleared, received data bits are automatically inverted to compensate for the inversion of data received on the 'image' frequency. Typical applications set this bit during initialization.
Bit 1	Overwrite Enable. When this bit is set, if an SOP is detected while the receive buffer is not empty, then the existing contents of receive buffer are lost, and the new packet is loaded into the receive buffer. When this bit is set, the RXOW IRQ is enabled. If this bit is cleared, then the receive buffer may not be overwritten by a new packet, and whenever the receive buffer is not empty SOP conditions are ignored, and it is not possible to receive data until the previously received packet has been completely read from the receive buffer.
Bit 0	Valid Flag Enable. When this bit is set, the receive buffer can store up to eight bytes of data. Typically, this bit is set only when interoperability with first generation devices is desired. See RX_BUFFER_ADR for more detail.



Mnemonic	RX_IRQ_STATUS_ADR			Address			0x07	
Bit	7	6	5	4	3	2	1	0
Default	-	-	-	-	-	-	-	-
Read/Write	R/W	R	R	R	R	R	R	R
Function	RXOW IRQ	SOPDET IRQ	RXB16 IRQ	RXB8 IRQ	RXB1 IRQ	RXBERRIRQ	RXC IRQ	RXE IRQ
<p>The state of all IRQ Status bits is valid regardless of whether or not the IRQ is enabled. The IRQ output of the device is in its active state whenever one or more bits in this register is set and the corresponding IRQ enable bit is also set. Status bits are non-atomic (different flags may change value at different times in response to a single event).</p>								
Bit 7	<p>Receive Overwrite Interrupt Status. This IRQ is triggered when the receive buffer is overwritten by a packet being received before the previous packet has been read from the buffer. This bit is cleared by writing any value to this register. This condition is only possible when the RXOW EN bit in RX_CFG_ADR is set. This bit must be written '1' by firmware before the new packet may be read from the receive buffer.</p>							
Bit 6	<p>Start of packet detect. This bit is set whenever the start of packet symbol is detected.</p>							
Bit 5	<p>Receive Buffer Full Interrupt Status. This bit is set whenever the receive buffer is full, and cleared otherwise.</p>							
Bit 4	<p>Receive Buffer Half Full Interrupt Status. This bit is set whenever there are eight or more bytes remaining in the receive buffer. Firmware must read exactly eight bytes when reading RXB8 IRQ.</p>							
Bit 3	<p>Receive Buffer Not Empty Interrupt Status. This bit is set any time that there are one or more bytes in the receive buffer, and cleared when the receive buffer is empty. It is possible, in rare cases, that the last byte of a packet may remain in the buffer even though the RXB1 IRQ flag has cleared. This can ONLY happen on the last byte of a packet and only if the packet data is being read out of the buffer while the packet is still being received. The flag is trustworthy under all other conditions, and for all bytes prior to the last. When using RXB1 IRQ and unloading the packet data during reception, the user must make sure the RX_COUNT_ADR value, after the RXC IRQ/RXE IRQ, is set and unload the last remaining bytes if the number of bytes unloaded is less than the reported count, even though the RXB1 IRQ is not set.</p>							
Bit 2	<p>Receive Buffer Error Interrupt Status. This IRQ is triggered in one of two ways: (1) When the receive buffer is empty and there is an attempt to read data (2) When the receive buffer is full and more data is received; this flag is cleared when RX GO is set and a SOP is received.</p>							
Bit 1	<p>Packet Receive Complete Interrupt Status. This IRQ is triggered when a packet has been received. If transaction mode is enabled, then this bit is not set until after transmission of the ACK. If transaction mode is not enabled then this bit is set as soon as a valid packet is received. This bit is cleared when this register is read. RXC IRQ and RXE IRQ flags may change value at different times in response to a single event. There are cases when this bit is not triggered when ACK EN = 1 and there is an error in reception. Therefore, firmware should examine RXC IRQ, RXE IRQ, and CRC 0 to determine receive status. If the first read of this register returns RXC IRQ = 1 and RXE IRQ = 0 then firmware must execute a second read to this register to determine if an error occurred by examining the status of RXE IRQ. If the first read of this register returns RXC IRQ = 1 and RXE IRQ = 1, then the firmware must not execute a second read to this register for a given transaction.</p>							
Bit 0	<p>Receive Error Interrupt Status. This IRQ is triggered when there is an error in reception. It is triggered whenever a packet is received with a bad CRC16, an unexpected EOP is detected, a packet type (data or ACK) mismatch, or a packet is dropped because the receive buffer is still not empty when the next packet starts. The exact cause of the error may be determined by reading RX_STATUS_ADR. This bit is cleared when this register is read.</p>							

Mnemonic	RX_STATUS_ADR						Address	0x08
Bit	7	6	5	4	3	2	1	0
Default	-	-	-	-	-	-	-	-
Read/Write	R	R	R	R	R	R	R	R
Function	RX ACK	PKT ERR	EOP ERR	CRC0	Bad CRC	RX Code	RX Data Mode	
<p>It is expected that firmware does not read this register until after RX GO self clears. Status bits are non-atomic (different flags may change value at different times in response to a single event).</p> <p>Bit 7      RX Packet Type. This bit is set when the received packet is an ACK packet, and cleared when the received packet is a standard packet.</p> <p>Bit 6      Receive Packet Type Error. This bit is set when the packet type received is not what was expected and cleared when the packet type received was as expected. For example, if a data packet is expected and an ACK is received, this bit is set.</p> <p>Bit 5      Unexpected EOP. This bit is set when an EOP is detected before the expected data length and CRC16 fields have been received. This bit is cleared when an SOP pattern for the next packet has been received. This includes the case where there are invalid bits detected in the length field and the length field is forced to '0'.</p> <p>Bit 4      Zero-seed CRC16. This bit is set whenever the CRC16 of the last received packet has a zero seed.</p> <p>Bit 3      Bad CRC16. This bit is set when the CRC16 of the last received packet is incorrect.</p> <p>Bit 2      Receive Code Length. This bit indicates the DATA_CODE_ADR code length used in the last correctly received packet. 1 = 64 chip code, 0 = 32 chip code.</p> <p>Bits 1:0    Receive Data Mode. These bits indicate the data mode of the last correctly received packet. 00 = 1 Mbps GFSK; 01 = 8DR; 10 = DDR; 11 = Not Valid. These bits do not apply to unframed packets.</p>								

Mnemonic	RX_COUNT_ADR						Address	0x09
Bit	7	6	5	4	3	2	1	0
Default	0	0	0	0	0	0	0	0
Read/Write	R	R	R	R	R	R	R	R
Function	RX Count							
<p>Count bits are non-atomic (updated at different times).</p> <p>Bits 7:0    This register contains the total number of payload bytes received during reception of the current packet. After packet reception is complete, this register matches the value in RX_LENGTH_ADR unless there was a packet error. This register is cleared when RX_LENGTH_ADR is automatically loaded, if length is enabled, after the SOP. Count should not be read when RX_GO = 1 during a transaction.</p>								

Mnemonic	RX_LENGTH_ADR						Address	0x0A
Bit	7	6	5	4	3	2	1	0
Default	0	0	0	0	0	0	0	0
Read/Write	R	R	R	R	R	R	R	R
Function	RX Length							
<p>Length bits are non-atomic (different flags may change value at different times in response to a single event).</p> <p>Bits 7:0    This register contains the length field which is updated with the reception of a new length field (shortly after start of packet detected). If there is an error in the received length field, 0x00 is loaded instead, except when using GFSK data rate, and an error is flagged.</p>								

Mnemonic	PWR_CTRL_ADR			Address				0x0B
Bit	7	6	5	4	3	2	1	0
Default	1	0	1	-	0	0	0	0
Read/Write	R/W	R/W	R/W	-	R/W	R/W	R/W	R/W
Function	PMU EN	LVIRQ EN	PMU Mode Force	PFET Disable	LVI TH		PMU OUTV	
Bit 7	Power Management Unit (PMU) Enable. Setting this bit enables the PMU only if PMU Mode Force (bit 5) is set. Otherwise it has no effect. See PMU Mode Force (bit 5) description for more information.							
Bit 6	Low Voltage Interrupt Enable. Setting this bit enables the LV IRQ interrupt. When this interrupt is enabled, if the $V_{BAT}$ voltage falls below the threshold set by LVI TH, a low voltage interrupt is generated. The LVI is not available when the device is in sleep mode. The LVI event on IRQ pin is automatically disabled whenever the PMU is disabled.							
Bit 5	PMU Mode Force. If this bit is set, the PMU operation is based on the state of the PMU Enable Bit (bit 7). If this bit is not set then the PMU is disabled in Sleep mode and enabled when not in Sleep mode, if Bit 7 = 1. If Bit 7 = 1 and Bit 5 = 1, PMU is enabled always (even during sleep). If Bit 7 = 0 and Bit 5 = 1, PMU is disabled always. If Bit 7 = 1 and Bit 5 = 0, PMU is disabled only in Sleep Mode.							
Bits 3:2	Low Voltage Interrupt Threshold. This field sets the voltage on $V_{BAT}$ at which the LVI is triggered. 11 = 1.8V; 10 = 2.0V; 01 = 2.2V; 00 = PMU OUTV voltage.							
Bits 1:0	PMU Output Voltage. This field sets the minimum output voltage of the PMU. 11 = 2.4V; 10 = 2.5V; 01 = 2.6V; 00 = 2.7V. When the PMU is active, the voltage output by the PMU on $V_{REG}$ is never less than this voltage, provided that the total load on the $V_{REG}$ pin is less than the specified maximum value, and the voltage in $V_{BAT}$ is greater than the specified minimum value.							
The order of writing these bits impacts the value of the Sleep current $I_{SB}$ .								

Mnemonic	XTAL_CTRL_ADR			Address				0x0C
Bit	7	6	5	4	3	2	1	0
Default	0	0	0	-	-	1	0	0
Read/Write	R/W	R/W	R/W	-	-	R/W	R/W	R/W
Function	XOUT FN		XSIRQ EN	Not Used	Not Used	FREQ		
Bits 7:6	XOUT Pin Function. This field selects between the different functions of the XOUT pin. 00 = Clock frequency set by XOUT FREQ; 01 = Active LOW PA Control; 10 = Radio data serial bit stream. If this option is selected and SPI is configured for 3-wire mode then the MISO pin outputs a serial clock associated with this data stream; 11 = GPIO. To disable this output, set to GPIO mode, and set the GPIO state in IO_CFG_ADR.							
Bit 5	Crystal Stable Interrupt Enable. This bit enables the OS IRQ interrupt. When enabled, this interrupt generates an IRQ event when the crystal has stabilized after the device has awoken from sleep mode. This event is cleared by writing '0' to this bit.							
Bits 2:0	XOUT Frequency. This field sets the frequency output on the XOUT pin when XOUT FN is set to 00. 0 = 12 MHz; 1 = 6 MHz, 2 = 3 MHz, 3 = 1.5 MHz, 4 = 0.75 MHz; other values are not defined.							

Mnemonic	IO_CFG_ADR						Address	0x0D
	7	6	5	4	3	2		
Bit	7	6	5	4	3	2	1	0
Default	0	0	0	0	0	0	0	0
Read/Write	R/W	R/W	R/W	R/W	R/W	R/W	R/W	R/W
Function	IRQ OD	IRQ POL	MISO OD	XOUT OD	PACTL OD	PACTL GPIO	SPI 3PIN	IRQ GPIO

To use a GPIO pin as an input, the output mode must be set to open drain, and '1' written to the corresponding output register bit.

Bit 7      IRQ Pin Drive Strength. Setting this bit configures the IRQ pin as an open drain output. Clearing this bit configures the IRQ pin as a standard CMOS output, with the output '1' drive voltage being equal to the  $V_{IO}$  pin voltage.

Bit 6      IRQ Polarity. Setting this bit configures the IRQ signal polarity to be active HIGH. Clearing this bit configures the IRQ signal polarity to be active low.

Bit 5      MISO Pin Drive Strength. Setting this bit configures the MISO pin as an open drain output. Clearing this bit configures the MISO pin as a standard CMOS output, with the output '1' drive voltage being equal to the  $V_{IO}$  pin voltage.

Bit 4      XOUT Pin Drive Strength. Setting this bit configures the XOUT pin as an open drain output. Clearing this bit configures the XOUT pin as a standard CMOS output, with the output '1' drive voltage being equal to the  $V_{IO}$  pin voltage.

Bit 3      PACTL Pin Drive Strength. Setting this bit configures the PACTL pin as an open drain output. Clearing this bit configures the PACTL pin as a standard CMOS output, with the output '1' drive voltage being equal to the  $V_{IO}$  pin voltage.

Bit 2      PACTL Pin Function. When this bit is set, the PACTL pin is available for use as a GPIO.

Bit 1      SPI Mode. When this bit is cleared, the SPI interface acts as a standard 4-wire SPI Slave interface. When this bit is set, the SPI interface operates in "3-Wire Mode" combining MISO and MOSI on the same pin (SDAT). The MISO pin is available as a GPIO pin.

Bit 0      IRQ Pin Function. When this bit is cleared, the IRQ pin is asserted when an IRQ is active; the polarity of this IRQ signal is configurable in IRQ POL. When this bit is set, the IRQ pin is available for use as a GPIO pin, and the IRQ function is multiplexed onto the MOSI pin. In this case the IRQ signal state is presented on the MOSI pin whenever the  $\overline{SS}$  signal is inactive (HIGH).

Mnemonic	GPIO_CTRL_ADR						Address	0x0E
	7	6	5	4	3	2		
Bit	7	6	5	4	3	2	1	0
Default	0	0	0	0	-	-	-	-
Read/Write	R/W	R/W	R/W	R/W	R	R	R	R
Function	XOUT OP	MISO OP	PACTL OP	IRQ OP	XOUT IP	MISO IP	PACTL IP	IRQ IP

To use a GPIO pin as an input, the output mode must be set to open drain, and a '1' written to the corresponding output register bit.

Bit 7      XOUT Output. When the XOUT pin is configured to be a GPIO, the state of this bit sets the output state of the XOUT pin.

Bit 6      MISO Output. When the MISO pin is configured to be a GPIO, the state of this bit sets the output state of the MISO pin.

Bit 5      PACTL Output. When the PACTL pin is configured to be a GPIO, the state of this bit sets the output state of the PACTL pin.

Bit 4      IRQ Output. When the IRQ pin is configured to be a GPIO, the state of this bit sets the output state of the IRQ pin.

Bit 3      XOUT Input. The state of this bit reflects the voltage on the XOUT pin.

Bit 2      MISO Input. The state of this bit reflects the voltage on the MISO pin.

Bit 1      PACTL Input. The state of this bit reflects the voltage on the PACTL pin.

Bit 0      IRQ Input. The state of this bit reflects the voltage on the IRQ pin.

Mnemonic	XACT_CFG_ADR			Address			0x0F	
	7	6	5	4	3	2		1
Bit	7	6	5	4	3	2	1	0
Default	1	-	0	0	0	0	0	0
Read/Write	R/W	-	R/W	R/W	R/W	R/W	R/W	R/W
Function	ACK EN	Not Used	FRC END	END STATE			ACK TO	
Bit 7	Acknowledge Enable. When this bit is set, an ACK packet is automatically transmitted whenever a valid packet is received; in this case the device is considered to be in transaction mode. After transmission of the ACK packet, the device automatically transitions to the END STATE. When this bit is cleared, the device transitions directly to the END STATE immediately after the end of packet transmission. This bit affects both transmitting and receiving devices.							
Bit 5	Force End State. Setting this bit forces a transition to the state set in END STATE. By setting the desired END STATE at the same time as setting this bit the device may be forced to immediately transition from its current state to any other state. This bit is automatically cleared upon completion. Firmware MUST never try to force END STATE while TX GO is set, nor when RX GO is set and a SOP has already been received (packet reception already in progress).							
Bits 4:2	Transaction End State. This field defines the mode to which the device transitions after receiving or transmitting a packet. 000 = Sleep Mode; 001 = Idle Mode; 010 = Synth Mode (TX); 011 = Synth Mode (RX); 100 = RX Mode. In normal use, this field is typically set to '000' or '001' when the device is transmitting packets, and '100' when the device is receiving packets. Note that when the device transitions to receive mode as an END STATE, the receiver must still be armed by setting RX GO before the device can begin receiving data. If the system only supports packets less than or equal to 16 bytes then firmware should examine RXC IRQ and RXE IRQ to determine the status of the packet. If the system supports packets more than 16 bytes, make sure that END STATE is not sleep, force RXF = 1, perform receive operation, force RXF = 0, and if necessary set END STATE back to sleep.							
Bits 1:0	ACK Timeout. When the device is configured for transaction mode, this field sets the timeout period after transmission of a packet during which an ACK must be correctly received in order to prevent a transmit error condition from being detected. This timeout period is expressed in terms of a number of SOP_CODE_ADR code lengths; if SOP LEN is set, then the timeout period is this value multiplied by 64 μs and if SOP LEN is cleared then the timeout is this value multiplied by 32 μs. 00 = 4x; 01 = 8x, 10 = 12x; 11 = 15x the SOP_CODE_ADR code length. ACK_TO must be set to greater than 30 + Data Code Length (only for 8DR) + Preamble Length + SOP Code Length (x2).							

Mnemonic	FRAMING_CFG_ADR			Address			0x10	
	7	6	5	4	3	2		1
Bit	7	6	5	4	3	2	1	0
Default	1	0	1	0	0	1	0	1
Read/Write	R/W	R/W	R/W	R/W	R/W	R/W	R/W	R/W
Function	SOP EN	SOP LEN	LEN EN	SOP TH				
Bit 7	SOP Enable. When this bit is set, each transmitted packet begins with a SOP field, and only packets beginning with a valid SOP field are received. If this bit is cleared, no SOP field is generated when a packet is transmitted, and packet reception begins whenever two successive correlations against the DATA_CODE_ADR code are detected.							
Bit 6	SOP PN Code Length. When this bit is set the SOP_CODE_ADR code length is 64 chips. When this bit is cleared the SOP_CODE_ADR code length is 32 chips.							
Bit 5	Packet Length Enable. When this bit is set the 8 bit value contained in TX_LENGTH_ADR is transmitted immediately after the SOP field. In receive mode, the 8 bits immediately following the SOP field are interpreted as the length of the packet. When this bit is cleared no packet length field is transmitted. 8DR always sends the packet length field (LEN EN setting is ignored). GFSK requires user set LEN EN = 1.							
Bits 4:0	SOP Correlator Threshold. This is the receive data correlator threshold used when attempting to detect a SOP symbol. There is a single threshold for the SOP_CODE_ADR code. This threshold is applied independently to each of SOP1 and SOP2 fields. When SOP LEN is set, all 5 bits of this field are used. When SOP LEN is cleared, the most significant bit is disregarded. Typical applications configure SOP TH = 04h for SOP32 and SOP TH = 0Eh for SOP64.							

Mnemonic	DATA32_THOLD_ADR				Address			0x11
Bit	7	6	5	4	3	2	1	0
Default	-	-	-	-	0	1	0	0
Read/Write	-	-	-	-	R/W	R/W	R/W	R/W
Function	Not Used	Not Used	Not Used	Not Used	TH32			
Bits 7:4	Not Used.							
Bits 3:0	32 Chip Data PN Code Correlator Threshold. This register sets the correlator threshold used in DSSS modes when DATA CODE LENGTH (see TX_CFG_ADR) is set to 32. Typical applications configure TH32 = 05h.							

Mnemonic	DATA64_THOLD_ADR			Address				0x12
Bit	7	6	5	4	3	2	1	0
Default	-	-	-	0	1	0	1	0
Read/Write	-	-	-	R/W	R/W	R/W	R/W	R/W
Function	Not Used	Not Used	Not Used	TH64				
Bits 7:5	Not Used.							
Bits 4:0	64 Chip Data PN Code Correlator Threshold. This register sets the correlator threshold used in DSSS modes when the DATA CODE LENGTH (see TX_CFG_ADR) is set to 64. Typical applications configure TH64 = 0Eh.							

Mnemonic	RSSI_ADR			Address				0x13
Bit	7	6	5	4	3	2	1	0
Default	0	-	1	0	0	0	0	0
Read/Write	R	-	R	R	R	R	R	R
Function	SOP	Not Used	LNA	RSSI				
<p>A Received Signal Strength Indicator (RSSI) reading is taken automatically when an SOP symbol is detected. In addition, an RSSI reading is taken whenever RSSI_ADR is read. The contents of this register are not valid after the device is configured for receive mode until either a SOP symbol is detected, or the register is (re)read. The conversion can occur as often as once every 12 <math>\mu</math>s. The approximate slope of the curve is 1.9 dB/count, but is not guaranteed.</p> <p>If it is desired to measure the background RF signal strength on a channel before a packet has been received then the MCU should perform a "dummy" read of this register, the results of which should be discarded. This "dummy" read causes an RSSI measurement to be taken, and therefore subsequent readings of the register yield valid data.</p> <p>Bit 7 SOP RSSI Reading. When set, this bit indicates that the reading in the RSSI field was taken when a SOP symbol was detected. When cleared, this bit indicates that the reading stored in the RSSI field was triggered by a previous SPI read of this register.</p> <p>Bit 5 LNA State. This bit indicates the LNA state when the RSSI reading was taken. When cleared, this bit indicates that the LNA was disabled when the RSSI reading was taken; if set this bit indicates that the LNA was enabled when the RSSI reading was taken.</p> <p>Bits 4:0 RSSI Reading. This field indicates the instantaneous strength of the RF signal being received at the time that the RSSI reading was taken. A larger value indicates a stronger signal. The signal strength measured is for the RF signal on the configured channel, and is measured after the LNA stage.</p>								

Mnemonic	EOP_CTRL_ADR							Address	0x14
Bit	7	6	5	4	3	2	1	0	
Default	1	0	1	0	0	1	0	0	
Read/Write	R/W	R/W	R/W	R/W	R/W	R/W	R/W	R/W	
Function	HEN	HINT			EOP				
<p>If the LEN EN bit is set, then the contents of this register have no effect. If the LEN EN bit is cleared, then this register is used to configure how an EOP (end of packet) condition is detected.</p> <p>Bit 7            EOP Hint Enable. When set, this bit causes an EOP to be detected if no correlations have been detected for the number of symbol periods set by the HINT field and the last two received bytes match the calculated CRC16 for all previously received bytes. Use of this mode reduces the chance of noncorrelations in the middle of a packet from being detected as an EOP condition.</p> <p>Bits 6:4        EOP Hint Symbol Count. The minimum number of symbols of consecutive noncorrelations at which the last two bytes are checked against the calculated CRC16 to detect an EOP condition.</p> <p>Bits 4:0        EOP Symbol Count. An EOP condition is deemed to exist when the number of consecutive noncorrelations is detected.</p>									

Mnemonic	CRC_SEED_LSB_ADR							Address	0x15
Bit	7	6	5	4	3	2	1	0	
Default	0	0	0	0	0	0	0	0	
Read/Write	R/W	R/W	R/W	R/W	R/W	R/W	R/W	R/W	
Function	CRC SEED LSB								
<p>The CRC16 seed allows different devices to generate or recognize different CRC16s for the same payload data. If a transmitter and receiver use a randomly selected CRC16 seed, the probability of correctly receiving data intended for a different receiver is 1/65535, even if the other transmitter/receiver are using the same SOP_CODE_ADR codes and channel.</p> <p>Bits 7:0        CRC16 Seed Least Significant Byte. The LSB of the starting value of the CRC16 calculation.</p>									

Mnemonic	CRC_SEED_MSB_ADR							Address	0x16
Bit	7	6	5	4	3	2	1	0	
Default	0	0	0	0	0	0	0	0	
Read/Write	R/W	R/W	R/W	R/W	R/W	R/W	R/W	R/W	
Function	CRC SEED MSB								
<p>Bits 7:0        CRC16 Seed Most Significant Byte. The MSB of the starting value of the CRC16 calculation.</p>									

Mnemonic	TX_CRC_LSB_ADR							Address	0x17
Bit	7	6	5	4	3	2	1	0	
Default	-	-	-	-	-	-	-	-	
Read/Write	R	R	R	R	R	R	R	R	
Function	TX CRC LSB								
<p>Bits 7:0        Calculated CRC16 LSB. The LSB of the CRC16 that was calculated for the last transmitted packet. This value is only valid after packet transmission is complete.</p>									

Mnemonic	TX_CRC_MSB_ADR			Address				0x18
Bit	7	6	5	4	3	2	1	0
Default	-	-	-	-	-	-	-	-
Read/Write	R	R	R	R	R	R	R	R
Function	TX CRC MSB							
Bits 7:0	Calculated CRC16 MSB. The MSB of the CRC16 that was calculated for the last transmitted packet. This value is only valid after packet transmission is complete.							

Mnemonic	RX_CRC_LSB_ADR			Address				0x19
Bit	7	6	5	4	3	2	1	0
Default	1	1	1	1	1	1	1	1
Read/Write	R	R	R	R	R	R	R	R
Function	RX CRC LSB							
Bits 7:0	Received CRC16 LSB. The LSB of the CRC16 field extracted from the last received packet. This value is valid whether or not the CRC16 field matched the calculated CRC16 of the received packet.							

Mnemonic	RX_CRC_MSB_ADR			Address				0x1A
Bit	7	6	5	4	3	2	1	0
Default	1	1	1	1	1	1	1	1
Read/Write	R	R	R	R	R	R	R	R
Function	RX CRC MSB							
Bits 7:0	Received CRC16 MSB. The MSB of the CRC16 field extracted from the last received packet. This value is valid whether or not the CRC16 field matched the calculated CRC16 of the received packet.							

Mnemonic	TX_OFFSET_LSB_ADR			Address				0x1B
Bit	7	6	5	4	3	2	1	0
Default	0	0	0	0	0	0	0	0
Read/Write	R/W	R	R	R	R	R	R	R
Function	STRIM LSB							
Bits 7:0	<p>The least significant 8 bits of the synthesizer offset value. This is a 12 bit 2's complement signed number, which may be used to offset the transmit frequency of the device by up to <math>\pm 1.5</math> MHz. A positive value increases the transmit frequency, and a negative value reduces the transmit frequency. A value of +1 increases the transmit frequency by 732.6 Hz; a value of -1 decreases the transmit frequency by 732.6 Hz. A value of 0x0555 increases the transmit frequency by 1 MHz; a value of 0xAAB decreases the transmit frequency by 1 MHz. Typically, this register is loaded with 0x55 during initialization. This feature is used to avoid the need to change the synthesizer frequency when switching between TX and RX. As the IF = 1 MHz the RX frequency is offset 1 MHz from the synthesizer frequency; therefore, transmitting with a 1 MHz offset allows the same synthesizer frequency to be used for both transmit and receive.</p> <p>Synthesizer offset has no effect on receive frequency.</p>							



Mnemonic	TX_OFFSET_MSB_ADR				Address			0x1C
Bit	7	6	5	4	3	2	1	0
Default	-	-	-	-	0	0	0	0
Read/Write	-	-	-	-	R/W	R/W	R/W	R/W
Function	Not Used	Not Used	Not Used	Not Used	STRIM MSB			
Bits 7:4	Not Used.							
Bits 3:0	The most significant 4 bits of the synthesizer trim value. Typically, this register is loaded with 0x05 during initialization.							

Mnemonic	MODE_OVERRIDE_ADR				Address			0x1D
Bit	7	6	5	4	3	2	1	0
Default	0	0	0	0	0	-	-	0
Read/Write	W	W	W	W	W	-	-	W
Function	RSVD	RSVD	FRC SEN	FRC AWAKE		Not Used	Not Used	RST
Bits 7:6	Reserved. Must be zero.							
Bit 5	Manually Initiate Synthesizer. Setting this bit forces the synthesizer to start. Clearing this bit has no effect. For this bit to operate correctly, the oscillator must be running before this bit is set.							
Bits 4:3	Force Awake. Force the device out of sleep mode. Setting both bits of this field forces the oscillator to keep running at all times regardless of the END STATE setting. Clearing both of these bits disables this function.							
Bits 2:1	Not Used.							
Bit 0	Reset. Setting this bit forces a full reset of the device. Clearing this bit has no effect.							

Mnemonic	RX_OVERRIDE_ADR				Address			0x1E
Bit	7	6	5	4	3	2	1	0
Default	0	0	0	0	0	0	0	-
Read/Write	R/W	R/W	R/W	R/W	R/W	R/W	R/W	-
Function	ACK RX	RXTX DLY	MAN RXACK	FRC RXDR	DIS CRC0	DIS RXCRC	ACE	Not Used
This register provides the ability to override some automatic features of the device.								
Bit 7	When this bit is set, the device uses the transmit synthesizer frequency rather than the receive synthesizer frequency for the given channel when automatically entering receive mode.							
Bit 6	When this bit is set and ACK EN is enabled, the transmission of the ACK packet is delayed by 20 $\mu$ s.							
Bit 5	Force Expected Packet Type. When this bit is set, and the device is in receive mode, the device is configured to receive an ACK packet at the data rate defined in TX_CFG_ADR.							
Bit 4	Force Receive Data Rate. When this bit is set, the receiver ignores the data rate encoded in the SOP symbol, and receives data at the data rate defined in TX_CFG_ADR.							
Bit 3	Reject packets with a zero-seed CRC16. Setting this bit causes the receiver to reject packets with a zero-seed, and accept only packets with a CRC16 that matches the seed in CRC_SEED_LSB_ADR and CRC_SEED_MSB_ADR.							
Bit 2	The RX CRC16 checker is disabled. If packets with CRC16 enabled are received, the CRC16 is treated as payload data and stored in the receive buffer.							
Bit 1	Accept Bad CRC16. Setting this bit causes the receiver to accept packets with a CRC16 that do not match the seed in CRC_SEED_LSB_ADR and CRC_SEED_MSB_ADR. An ACK is to be sent regardless of the condition of the received CRC16.							
Bit 0	Not Used.							

Mnemonic	TX_OVERRIDE_ADR						Address	0x1F
Bit	7	6	5	4	3	2	1	0
Default	0	0	0	0	0	0	0	0
Read/Write	R/W	R/W	R/W	R/W	R/W	R/W	R/W	R/W
Function	ACK TX	FRC PRE	RSVD	MAN TXACK	OVRD ACK	DIS TXCRC	RSVD	TX INV

This register provides the ability to override some automatic features of the device.

Bit 7 When this bit is set, the device uses the receive synthesizer frequency rather than the transmit synthesizer frequency for the given channel when automatically entering transmit mode.

Bit 6 Force Preamble. When this bit is set, the device transmits a continuous repetition of the preamble pattern (see PREAMBLE\_ADR) after TX GO is set. This mode is useful for some regulatory approval procedures. Firmware should set bit RST of MODE\_OVERRIDE\_ADR to exit this mode.

Bit 5 Reserved. Must be zero.

Bit 4 Transmit ACK Packet. When this bit is set, the device sends an ACK packet when TX GO is set.

Bit 3 ACK Override. Use TX\_CFG\_ADR to determine the data rate and the CRC16 used when transmitting an ACK packet.

Bit 2 Disable Transmit CRC16. When set, no CRC16 field is present at the end of transmitted packets.

Bit 1 Reserved. Must be zero.

Bit 0 TX Data Invert. When this bit is set the transmit bitstream is inverted.

Mnemonic	XTAL_CFG_ADR						Address	0x26
Bit	7	6	5	4	3	2	1	0
Default	0	0	0	0	0	0	0	0
Read/Write	W	W	W	W	W	W	W	W
Function	RSVD	RSVD	RSVD	RSVD	START DLY	RSVD	RSVD	RSVD

This register provides the ability to override some automatic features of the device.

Bits 7:4 Reserved. Must be zero.

Bit 3 Crystal Startup Delay. Setting this bit, sets the crystal startup delay to 150  $\mu$ s to handle warm restarts of the crystal. Firmware MUST set this bit during initialization.

Bits 2:0 Reserved. Must be zero.

Mnemonic	CLK_OVERRIDE_ADR						Address	0x27
Bit	7	6	5	4	3	2	1	0
Default	0	0	0	0	0	0	0	0
Read/Write	W	W	W	W	W	W	W	W
Function	RSVD	RSVD	RSVD	RSVD	RSVD	RSVD	RXF	RSVD

This register provides the ability to override some automatic features of the device.

Bits 7:2 Reserved. Must be zero.

Bit 1 Force Receive Clock. Streaming applications MUST set this bit during receive mode, otherwise this bit is cleared.

Bit 0 Reserved. Must be zero.

Mnemonic	CLK_EN_ADR						Address	0x28
Bit	7	6	5	4	3	2	1	0
Default	0	0	0	0	0	0	0	0
Read/Write	W	W	W	W	W	W	W	W
Function	RSVD	RSVD	RSVD	RSVD	RSVD	RSVD	RXF	RSVD

This register provides the ability to override some automatic features of the device.

Bits 7:2 Reserved. Must be zero.

Bit 1 Force Receive Clock Enable. Streaming applications MUST set this bit during initialization.

Bit 0 Reserved. Must be zero.

Mnemonic	RX_ABORT_ADR						Address	0x29
Bit	7	6	5	4	3	2	1	0
Default	0	0	0	0	0	0	0	0
Read/Write	W	W	W	W	W	W	W	W
Function	RSVD	RSVD	ABORT EN	RSVD	RSVD	RSVD	RSVD	RSVD

This register provides the ability to override some automatic features of the device.

Bits 7:6 Reserved. Must be zero.

Bit 5 Receive Abort Enable. Typical applications disrupt any pending receive by first setting this bit, otherwise this bit is cleared.

Bits 4:0 Reserved. Must be zero.

Mnemonic	AUTO_CAL_TIME_ADR						Address	0x32
Bit	7	6	5	4	3	2	1	0
Default	0	0	0	0	0	0	1	1
Read/Write	W	W	W	W	W	W	W	W
Function	AUTO_CAL_TIME							

This register provides the ability to override some automatic features of the device.

Bits 7:0 Auto Cal Time. Firmware MUST write 3Ch to this register during initialization.

Mnemonic	AUTO_CAL_OFFSET_ADR						Address	0x35
Bit	7	6	5	4	3	2	1	0
Default	0	0	0	0	0	0	0	0
Read/Write	W	W	W	W	W	W	W	W
Function	AUTO_CAL_OFFSET							

This register provides the ability to override some automatic features of the device.

Bits 7:0 Auto Cal Offset. Firmware MUST write 14h to this register during initialization.

Mnemonic	ANALOG_CTRL_ADR						Address	0x39
Bit	7	6	5	4	3	2	1	0
Default	0	0	0	0	0	0	0	0
Read/Write	W	W	W	W	W	W	W	W
Function	RSVD	RSVD	RSVD	RSVD	RSVD	RSVD	RX INV	ALL SLOW

This register provides the ability to override some automatic features of the device.

Bits 7:2 Reserved. Must be zero.

Bit 1 Receive Invert. When set, the incoming receive data is inverted. Firmware **MUST** set this bit when interoperability with first generation devices is desired.

Bit 0 All Slow. When set, the synth settling time for all channels is the same as for slow channels. It is recommended that firmware set this bit when using GFSK data rate mode.

**Register Files**

Files are written to or read from using nonincrementing burst read or write transactions. In most cases, accessing a file may be destructive; the file must be completely read/written, otherwise the contents may be altered. When accessing file registers, the bytes are presented to the bus least significant byte first.

Mnemonic	TX_BUFFER_ADR	Address	0x20
Length	16 Bytes	R/W	W
Default	0xFFFFFFFFFFFFFFFFFFFFFFFFFFFFFFFF		

The transmit buffer is a FIFO. Writing to this file adds a byte to the packet being sent. Writing more bytes to this file than the packet length in TX\_LENGTH\_ADR has no effect, and these bytes are lost. The FIFO accumulates data until it is reset using TX CLR in TX\_CTRL\_ADR. A previously sent packet, of 16 bytes or less, can be transmitted if TX\_GO is set without resetting the FIFO. The contents of TX\_BUFFER\_ADR are not affected by the transmission of an Auto ACK.

Mnemonic	RX_BUFFER_ADR	Address	0x21
Length	16 Bytes	R/W	R
Default	0xFFFFFFFFFFFFFFFFFFFFFFFFFFFFFFFF		

The receive buffer is a FIFO. Received bytes may be read from this file register at any time that it is not empty, but when reading from this file register before a packet has been completely received care must be taken to ensure that error packets (for example with bad CRC16) are handled correctly.

When the receive buffer is configured to be overwritten by new packets (the alternative is for new packets to be discarded if the receive buffer is not empty), similar care must be taken to verify after the packet has been read from the buffer that no part of it was overwritten by a newly received packet while this file register is being read.

When the VLD EN bit in RX\_CFG\_ADR is set, the bytes in this file register alternate—the first byte read is data, the second byte is a valid flag for each bit in the first byte, the third byte is data, the fourth byte valid flags, and so on. In SDR and DDR modes the valid flag for a bit is set if the correlation coefficient for the bit exceeds the correlator threshold, and is cleared if it does not. In 8DR mode, the MSB of a valid flags byte indicates whether or not the correlation coefficient of the corresponding received symbol exceeds the threshold. The seven LSBs contain the number of erroneous chips received for the data.

Mnemonic	SOP_CODE_ADR	Address	0x22
Length	8 Bytes	R/W	R/W
Default	0x17FF9E213690C782		

When using 32 chip SOP\_CODE\_ADR codes, only the first four bytes of this register are used; in order to complete the file write process, these four bytes must be followed by four bytes of “dummy” data. However, a class of codes known as “multiplicative codes” may be used; there are 64 chip codes with good auto-correlation and cross-correlation properties where the least significant 32 chips themselves have good auto-correlation and cross-correlation properties when used as 32 chip codes. In this case the same eight byte value may be loaded into this file and used for both 32 chip and 64 chip SOP symbols.

When reading this file, all eight bytes must be read; if fewer than eight bytes are read from the file, the contents of the file will have been rotated by the number of bytes read. This applies to writes, as well.

Do not access or modify this register during Transmit or Receive.

Recommended SOP Codes:  
0x91CCF8E291CC373C  
0x0FA239AD0FA1C59B  
0x2AB18FD22AB064EF  
0x507C26DD507CCD66  
0x44F616AD44F6E15C  
0x46AE31B646AECC5A  
0x3CDC829E3CDC78A1  
0x7418656F74198EB9  
0x49C1DF6249C0B1DF  
0x72141A7F7214E597

Mnemonic	DATA_CODE_ADR	Address	0x23
Length	16 Bytes	R/W	R/W
Default	0x02F9939702FA5CE3012BF1DB0132BE6F		

In GFSK mode, this file register is ignored.

In 64 SDR mode, only the first eight bytes are used.

In 32 DDR mode, only eight bytes are used. The format for these eight bytes: 0x00000000BBBBBBBB00000000AAAAAAAA, where ‘0’ represents unused locations. Example: 0x00000000B2BB092B00000000B86BC0DC; where “B86BC0DC” represents AAAAAAAA, “00000000” represents unused locations, “B2BB092B” represents BBBBBBBB, and “00000000” represents unused locations.

In 64 DDR and 8DR modes, all sixteen bytes are used.

When reading this file, all sixteen bytes must be read; if fewer than sixteen bytes are read from the file, the contents of the file will have been rotated by the number of bytes read. This applies to writes, as well.

Certain 16 byte sequences have been calculated that provide excellent auto-correlation and cross-correlation properties, and it is recommended that such sequences be used; the default value of this register is one such sequence. In typical applications, all devices use the same DATA\_CODE\_ADR codes, and devices and systems are addressed by using different SOP\_CODE\_ADR codes; in such cases it may never be necessary to change the contents of this register from the default value.

Typical applications should use the default code.

Do not access or modify this register during Transmit or Receive.

Mnemonic	PREAMBLE_ADR	Address	0x24
Length	3 Bytes	R/W	R/W
Default	0x333302		

1st byte – The number of repetitions of the preamble sequence that are to be transmitted. The preamble may be disabled by writing 0x00 to this byte.

2nd byte – Least significant eight chips of the preamble sequence

3rd byte – Most significant eight chips of the preamble sequence

If using 64 SDR to communicate with CYWUSB69xx devices, set number of repetitions to four for optimum performance

When reading this file, all three bytes must be read; if fewer than three bytes are read from the file, the contents of the file will have been rotated by the number of bytes read. This also applies to writes.

Do not access or modify this register during Transmit or Receive.

Mnemonic	MFG_ID_ADR	Address	0x25
<b>Length</b>	6 Bytes	R	R
<b>Default</b>	NA		

To minimize ~190  $\mu$ A of current consumption (default), execute a “dummy” single-byte SPI write to this address with a zero data stage after the contents have been read. Non-zero to enable reading of fuses. Zero to disable reading fuses.

### Absolute Maximum Ratings

Storage Temperature ..... -65°C to +150°C  
 Ambient Temperature with Power Applied .. -55°C to +125°C  
 Supply Voltage on any power supply pin  
 relative to  $V_{SS}$  ..... -0.3V to +3.9V  
 DC Voltage to Logic Inputs<sup>[5]</sup> ..... -0.3V to  $V_{IO}$  +0.3V  
 DC Voltage applied to Outputs  
 in High-Z State ..... -0.3V to  $V_{IO}$  +0.3V  
 Static Discharge Voltage (Digital)<sup>[6]</sup> ..... >2000V

Static Discharge Voltage (RF)<sup>[6]</sup> ..... 1100V  
 Latch Up Current ..... +200 mA, -200 mA

### Operating Conditions

$V_{CC}$  ..... 2.4V to 3.6V  
 $V_{IO}$  ..... 1.8V to 3.6V  
 $V_{BAT}$  ..... 1.8V to 3.6V  
 $T_A$  (Ambient Temperature Under Bias) ..... 0°C to +70°C  
 Ground Voltage ..... 0V  
 $f_{OSC}$  (Crystal Frequency) ..... 12MHz  $\pm$ 30 ppm

### DC Characteristics

( $T = 25^\circ\text{C}$ ,  $V_{BAT} = 2.4\text{V}$ , PMU disabled,  $f_{OSC} = 12.000000\text{MHz}$ )

Parameter	Description	Conditions	Min	Typ	Max	Unit
$V_{BAT}$	Battery Voltage	0–70°C	1.8		3.6	V
$V_{REG}$ <sup>[7]</sup>	PMU Output Voltage	2.4V mode	2.4	2.43		V
$V_{REG}$ <sup>[7]</sup>	PMU Output Voltage	2.7V mode	2.7	2.73		V
$V_{IO}$ <sup>[8]</sup>	$V_{IO}$ Voltage		1.8		3.6	V
$V_{CC}$	$V_{CC}$ Voltage	0–70°C	2.4 <sup>[9]</sup>		3.6	V
$V_{OH1}$	Output High Voltage Condition 1	At $I_{OH} = -100.0 \mu\text{A}$	$V_{IO} - 0.2$	$V_{IO}$		V
$V_{OH2}$	Output High Voltage Condition 2	At $I_{OH} = -2.0 \text{ mA}$	$V_{IO} - 0.4$	$V_{IO}$		V
$V_{OL}$	Output Low Voltage	At $I_{OL} = 2.0 \text{ mA}$		0	0.45	V
$V_{IH}$	Input High Voltage		$0.7V_{IO}$		$V_{IO}$	V
$V_{IL}$	Input Low Voltage		0		$0.3V_{IO}$	V
$I_{IL}$	Input Leakage Current	$0 < V_{IN} < V_{IO}$	-1	0.26	+1	$\mu\text{A}$
$C_{IN}$	Pin Input Capacitance	except XTAL, $RF_N$ , $RF_P$ , $RF_{BIAS}$		3.5	10	pF
$I_{CC}$ (GFSK) <sup>[10]</sup>	Average TX $I_{CC}$ , 1 Mbps, slow channel	PA = 5, 2 way, 4 bytes/10 ms		0.87		mA
$I_{CC}$ (32-8DR) <sup>[10]</sup>	Average TX $I_{CC}$ , 250 kbps, fast channel	PA = 5, 2 way, 4 bytes/10 ms		1.2		mA
$I_{SB}$ <sup>[11]</sup>	Sleep Mode $I_{CC}$			0.8	10	$\mu\text{A}$
$I_{SB}$ <sup>[11]</sup>	Sleep Mode $I_{CC}$	PMU enabled		31.4		$\mu\text{A}$
IDLE $I_{CC}$	Radio off, XTAL Active	XOUT disabled		1.0		mA
$I_{synth}$	$I_{CC}$ during Synth Start			8.4		mA
TX $I_{CC}$	$I_{CC}$ during Transmit	PA = 5 (-5 dBm)		20.8		mA
TX $I_{CC}$	$I_{CC}$ during Transmit	PA = 6 (0 dBm)		26.2		mA
TX $I_{CC}$	$I_{CC}$ during Transmit	PA = 7 (+4 dBm)		34.1		mA
RX $I_{CC}$	$I_{CC}$ during Receive	LNA off, ATT on		18.4		mA
RX $I_{CC}$	$I_{CC}$ during Receive	LNA on, ATT off		21.2		mA
Boost Eff	PMU Boost Converter Efficiency	$V_{BAT} = 2.5\text{V}$ , $V_{REG} = 2.73\text{V}$ , $I_{LOAD} = 20 \text{ mA}$		81		%

#### Notes

- It is permissible to connect voltages above  $V_{IO}$  to inputs through a series resistor limiting input current to 1 mA. AC timing not guaranteed.
- Human Body Model (HBM).
- $V_{REG}$  depends on battery input voltage.
- In sleep mode, the I/O interface voltage reference is  $V_{BAT}$ .
- In sleep mode,  $V_{CC}$  min. can go as low as 1.8V.
- Includes current drawn while starting crystal, starting synthesizer, transmitting packet (including SOP and CRC16), changing to receive mode, and receiving ACK handshake. Device is in sleep except during this transaction.
- ISB is not guaranteed if any I/O pin is connected to voltages higher than  $V_{IO}$ .

**DC Characteristics**

(T = 25°C, V<sub>BAT</sub> = 2.4V, PMU disabled, f<sub>OSC</sub> = 12.000000MHz) (continued)

Parameter	Description	Conditions	Min	Typ	Max	Unit
I <sub>LOAD_EXT</sub>	Average PMU External Load current	V <sub>BAT</sub> = 1.8V, V <sub>REG</sub> = 2.73V, 0–50°C, RX Mode			15	mA
I <sub>LOAD_EXT</sub>	Average PMU External Load current	V <sub>BAT</sub> = 1.8V, V <sub>REG</sub> = 2.73V, 50–70°C, RX Mode			10	mA

**AC Characteristics<sup>[12]</sup>**

**Table 6. SPI Interface<sup>[13]</sup>**

Parameter	Description	Min	Typ	Max	Unit
t <sub>SCK_CYC</sub>	SPI Clock Period	238.1			ns
t <sub>SCK_HI</sub>	SPI Clock High Time	100			ns
t <sub>SCK_LO</sub>	SPI Clock Low Time	100			ns
t <sub>DAT_SU</sub>	SPI Input Data Setup Time	25			ns
t <sub>DAT_HLD</sub>	SPI Input Data Hold Time	10			ns
t <sub>DAT_VAL</sub>	SPI Output Data Valid Time	0		50	ns
t <sub>DAT_VAL_TRI</sub>	SPI Output Data Tri-state (MOSI from Slave Select Deassert)			20	ns
t <sub>SS_SU</sub>	SPI Slave Select Setup Time before first positive edge of SCK <sup>[14]</sup>	10			ns
t <sub>SS_HLD</sub>	SPI Slave Select Hold Time after last negative edge of SCK	10			ns
t <sub>SS_PW</sub>	SPI Slave Select Minimum Pulse Width	20			ns
t <sub>SCK_SU</sub>	SPI Slave Select Setup Time	10			ns
t <sub>SCK_HLD</sub>	SPI SCK Hold Time	10			ns
t <sub>RESET</sub>	Minimum RST Pin Pulse Width	10			ns

**Figure 11. SPI Timing**

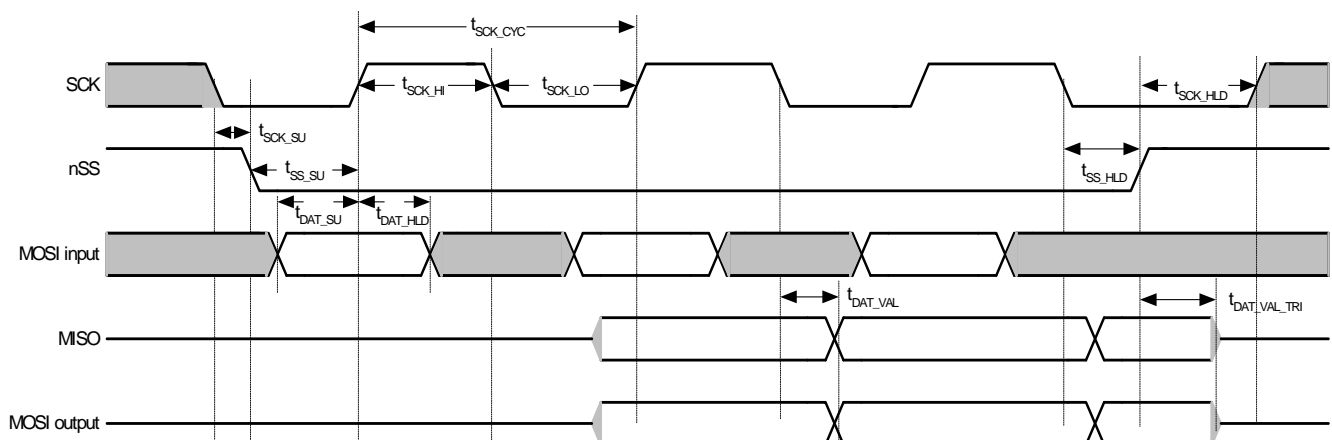

**Notes**

- 12. AC values are not guaranteed if voltage on any pin exceed V<sub>IO</sub>.
- 13. C<sub>LOAD</sub> = 30 pF.
- 14. SCK must start low at the time  $\overline{SS}$  goes LOW, otherwise the success of SPI transactions are not guaranteed.



**RF Characteristics**
**Table 7. Radio Parameters**

Parameter Description	Conditions	Min	Typ	Max	Unit
RF Frequency Range	Note 15	2.400		2.497	GHz
<b>Receiver</b> (T = 25°C, V <sub>CC</sub> = 3.0V, f <sub>OSC</sub> = 12.000000MHz, BER < 1E-3)					
Sensitivity 125 kbps 64-8DR	BER 1E-3		-97		dBm
Sensitivity 250 kbps 32-8DR	BER 1E-3		-93		dBm
Sensitivity	CER 1E-3	-80	-87		dBm
Sensitivity GFSK	BER 1E-3, ALL SLOW = 1		-84		dBm
LNA Gain			22.8		dB
ATT Gain			-31.7		dB
Maximum Received Signal	LNA On	-15	-6		dBm
RSSI Value for PWR <sub>in</sub> -60 dBm	LNA On		21		Count
RSSI Slope			1.9		dB/Count
<b>Interference Performance</b> (CER 1E-3)					
Co-channel Interference rejection Carrier-to-Interference (C/I)	C = -60 dBm		9		dB
Adjacent (±1 MHz) channel selectivity C/I 1 MHz	C = -60 dBm		3		dB
Adjacent (±2 MHz) channel selectivity C/I 2 MHz	C = -60 dBm		-30		dB
Adjacent (≥ 3 MHz) channel selectivity C/I ≥ 3 MHz	C = -67 dBm		-38		dB
Out-of-Band Blocking 30 MHz–12.75 MHz <sup>[16]</sup>	C = -67 dBm		-30		dBm
Intermodulation	C = -64 dBm, Δf = 5,10 MHz		-36		dBm
<b>Receive Spurious Emission</b>					
800 MHz	100 kHz ResBW		-79		dBm
1.6 GHz	100 kHz ResBW		-71		dBm
3.2 GHz	100 kHz ResBW		-65		dBm
<b>Transmitter</b> (T = 25°C, V <sub>CC</sub> = 3.0V)					
Maximum RF Transmit Power	PA = 7	+2	4	+6	dBm
Maximum RF Transmit Power	PA = 6	-2	0	+2	dBm
Maximum RF Transmit Power	PA = 5	-7	-5	-3	dBm
Maximum RF Transmit Power	PA = 0		-35		dBm
RF Power Control Range			39		dB
RF Power Range Control Step Size	Seven steps, monotonic		5.6		dB
Frequency Deviation Min	PN Code Pattern 10101010		270		kHz
Frequency Deviation Max	PN Code Pattern 11110000		323		kHz
Error Vector Magnitude (FSK error)	>0 dBm		10		%rms
Occupied Bandwidth	-6 dBc, 100 kHz ResBW	500	876		kHz
<b>Transmit Spurious Emission</b> (PA = 7)					
In-band Spurious Second Channel Power (±2 MHz)			-38		dBm
In-band Spurious Third Channel Power (≥3 MHz)			-44		dBm

**Notes**

15. Subject to regulation.  
16. Exceptions F/3 & 5C/3.

Table 7. Radio Parameters (continued)

Parameter Description	Conditions	Min	Typ	Max	Unit
Non-Harmonically Related Spurs (800 MHz)			-38		dBm
Non-Harmonically Related Spurs (1.6 GHz)			-34		dBm
Non-Harmonically Related Spurs (3.2 GHz)			-47		dBm
Harmonic Spurs (Second Harmonic)			-43		dBm
Harmonic Spurs (Third Harmonic)			-48		dBm
Fourth and Greater Harmonics			-59		dBm
<b>Power Management</b> (Crystal PN# eCERA GF-1200008)					
Crystal Start to 10ppm			0.7	1.3	ms
Crystal Start to IRQ	XSIRQ EN = 1		0.6		ms
Synth Settle	Slow channels			270	µs
Synth Settle	Medium channels			180	µs
Synth Settle	Fast channels			100	µs
Link Turnaround Time	GFSK			30	µs
Link Turnaround Time	250 kbps			62	µs
Link Turnaround Time	125 kbps			94	µs
Link Turnaround Time	<125 kbps			31	µs
Max Packet Length	<60 ppm crystal-to-crystal all modes except 64-DDR			40	bytes
Max Packet Length	<60 ppm crystal-to-crystal 64-DDR			16	bytes

Typical Operating Characteristics<sup>[17]</sup>

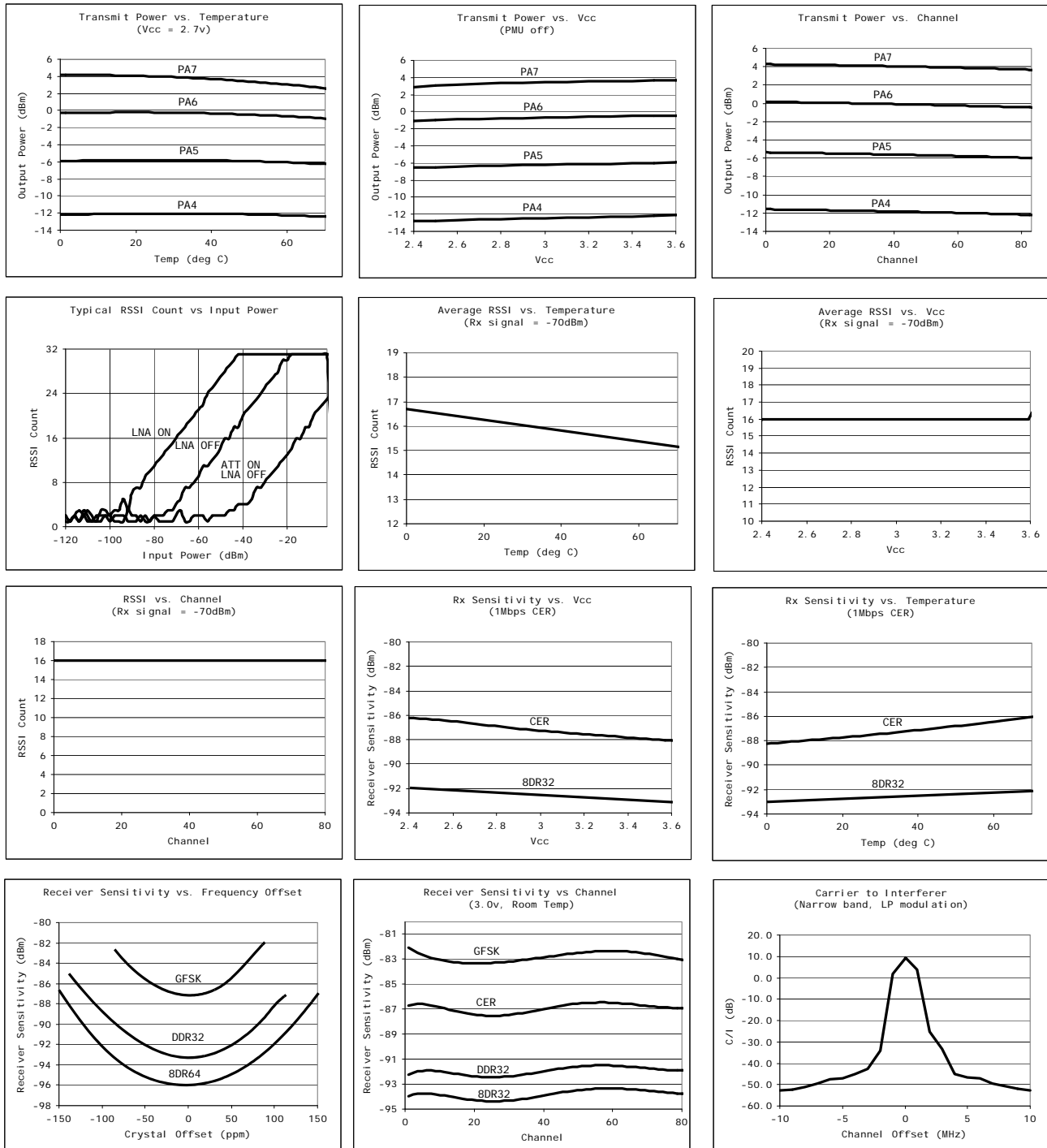

Note

17. With LNA on, ATT off, above -2dBm erroneous RSSI values may be read, cross-checking RSSI with LNA off/on is recommended for accurate readings.

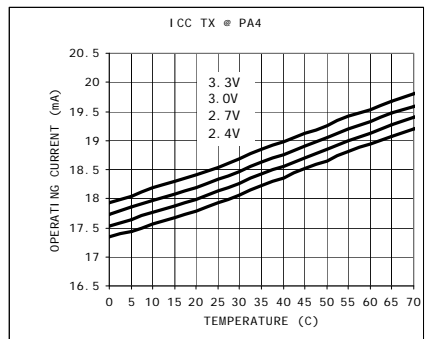
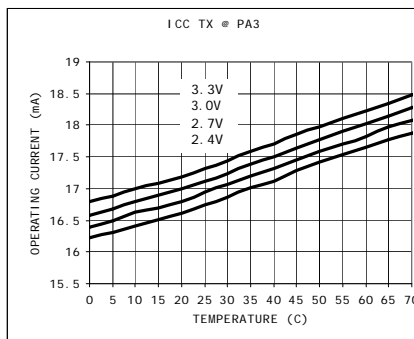
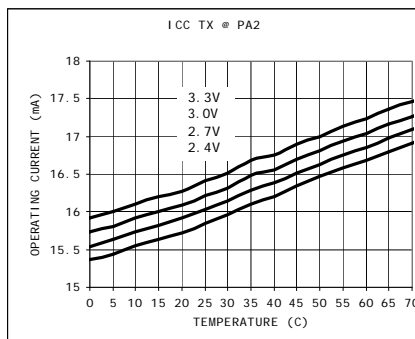
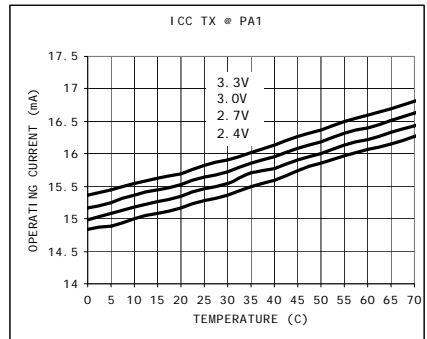
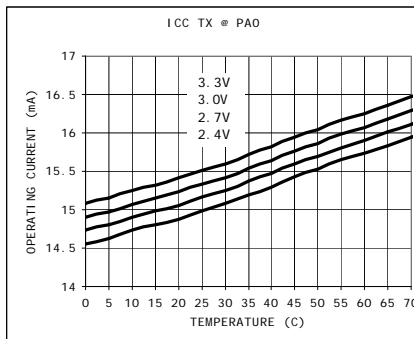
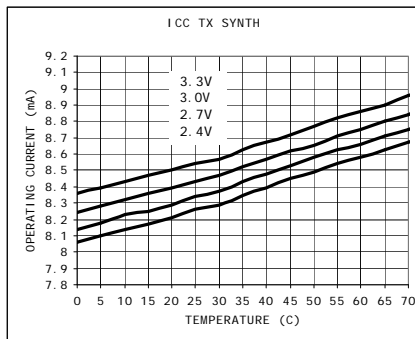
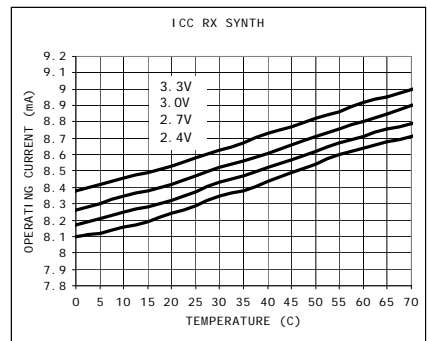
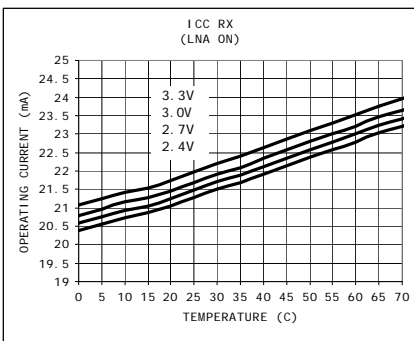
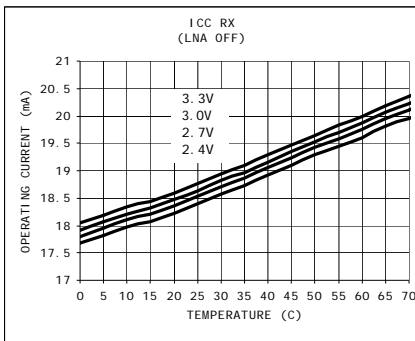
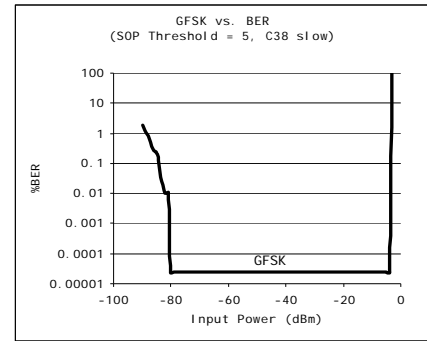
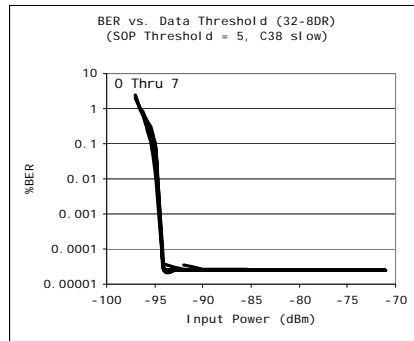
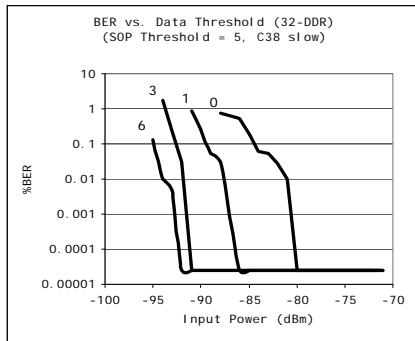

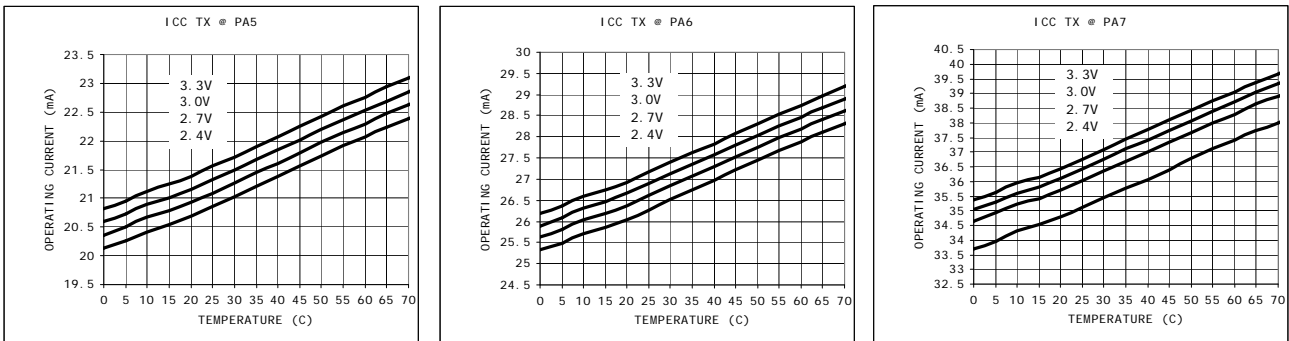

### AC Test Loads and Waveforms for Digital Pins

Figure 12. AC Test Loads and Waveforms for Digital Pins

#### AC Test Loads

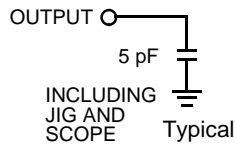
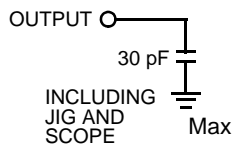

#### DC Test Load

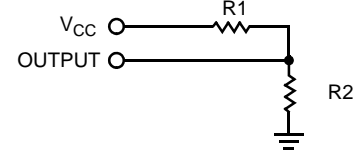

Parameter		Unit
R1	1071	Ω
R2	937	Ω
R <sub>TH</sub>	500	Ω
V <sub>TH</sub>	1.4	V
V <sub>CC</sub>	3.00	V

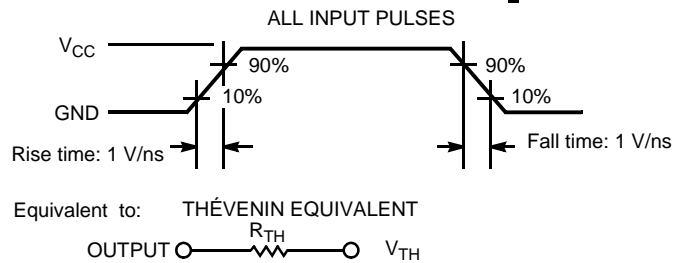

### Ordering Information

Table 8. Ordering Information

Part Number	Radio	Package Name	Package Type	Operating Range
CYRF6936-40LFXC	Transceiver	40 QFN	40 Quad Flat Package No Leads Lead-Free	Commercial

Package Description

Figure 13. 40-lead Pb-Free QFN 6 x 6 MM (Subcon Punch Type with 2.8 x 2.8 EPAD) LY40

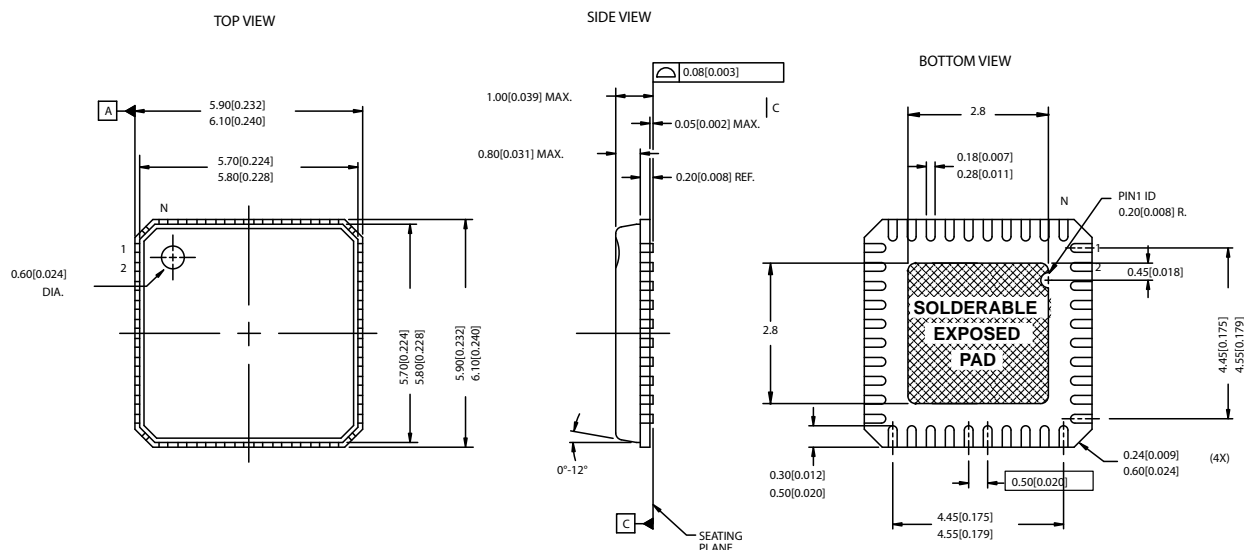

NOTES:

1.  HATCH IS SOLDERABLE EXPOSED AREA
2. REFERENCE JEDEC#: MO-220
3. PACKAGE WEIGHT: 0.086g
4. ALL DIMENSIONS ARE IN MM [MIN/MAX]
5. PACKAGE CODE

PART #	DESCRIPTION
LY40	PB-FREE
LF40	STANDARD

51-85190-\*A

The recommended dimension of the PCB pad size for the E-PAD underneath the QFN is 3.5 mm x 3.5 mm (width x length).

This document is subject to change, and may be found to contain errors of omission or changes in parameters. For feedback or technical support regarding Cypress WirelessUSB products, contact Cypress at [www.cypress.com](http://www.cypress.com). WirelessUSB, PSoc, and enCoRe are trademarks of Cypress Semiconductor. All product and company names mentioned in this document are the trademarks of their respective holders.

Document History Page

Description Title: CYRF6936 WirelessUSB™ LP 2.4 GHz Radio SoC Document Number: 38-16015				
REV.	ECN NO.	Issue Date	Orig. of Change	Description of Change
**	307437	See ECN	TGE	New data sheet
*A	377574	See ECN	TGE	Preliminary release– - updated Section 1.0 - Features - updated Section 2.0 - Applications - added Section 3.0 - Applications Support - updated Section 4.0 - Functional Descriptions - updated Section 5.0 - Pin Description - added Figure 5-1 - updated Section 6.0 - Functional Overview - added Section 7.0 - Functional Block Overview - added Section 9.0 - Register Descriptions - updated Section 10.0 - Absolute Maximum Ratings - updated Section 11.0 - Operating Conditions - updated Section 12.0 - DC Characteristics - updated Section 13.0 - AC Characteristics - updated Section 14.0 - RF Characteristics - added Section 16.0 - Ordering Information
*B	398756	See ECN	TGE	ES-10 update- - changed part no. - updated Section 9.0 - Register Descriptions - updated Section 12.0 - DC Characteristics - updated Section 14.0 - RF Characteristics
*C	412778	See ECN	TGE	ES-10 update- - updated Section 4.0 - Functional Descriptions - updated Section 5.0 - Pin Descriptions - updated Section 6.0 - Functional Overview - updated Section 7.0 - Functional Block Overview - updated Section 9.0 - Register Descriptions - updated Section 10.0 - Absolute Maximum Ratings - updated Section 11.0 - Operating Conditions - updated Section 14.0 - RF Characteristics
*D	435578	See ECN	TGE	- updated Section 1.0 - Features - updated Section 5.0 - Pin Descriptions - updated Section 6.0 - Functional Overview - updated Section 7.0 - Functional Block Overview - updated Section 9.0 - Register Descriptions - added Section 10.0 - Recommended Radio Circuit Schematic - updated Section 11.0 - Absolute Maximum Ratings - updated Section 12.0 - Operating Conditions - updated Section 13.0 - DC Characteristics - updated Section 14.0 - AC Characteristics - updated Section 15.0 - RF Characteristics
*E	460458	See ECN	BOO	Final data sheet - removed “Preliminary” notation
*F	487261	See ECN	TGE	- updated Section 1.0 - Features - updated Section 5.0 - Pin Descriptions - updated Section 6.0 - Functional Overview - updated Section 7.0 - Functional Block Overview - updated Section 8.0 - Application Example - updated Section 9.0 - Register Descriptions - updated Section 12.0 - DC Characteristics - updated Section 13.0 - AC Characteristics - updated Section 14.0 - RF Characteristics - added Section 15.0 - Typical Operating Characteristics

**Description Title: CYRF6936 WirelessUSB™ LP 2.4 GHz Radio SoC**  
**Document Number: 38-16015**

*G	778236	See ECN	OYR/ARI	<ul style="list-style-type: none"> <li>-modified radio function register descriptions</li> <li>-changed L/D pin description</li> <li>-footnotes added</li> <li>-changed RST Capacitor from 0.1uF to 0.47 uF</li> <li>-updated Figure 9, Recommended Circuit for Systems</li> <li>-updated Table 3, Recommended bill of materials for systems</li> <li>-updated package diagram from ** to *A</li> </ul>
----	--------	---------	---------	---