



SIOV metal oxide varistors

Leaded varistors, SuperioR-MP series

Series/Type: S20
Date: December 2007

© EPCOS AG 2008. Reproduction, publication and dissemination of this publication, enclosures hereto and the information contained therein without EPCOS' prior express consent is prohibited.

Leaded varistors

SuperioR-MP, S20 series

Construction

- Round varistor element, leaded
- Coating: epoxy resin, flame-retardant to UL 94 V-0
- Terminals: tinned copper wire

Features

- Wide operating voltage range 275 ... 460 V_{RMS}
- Multiple pulse handling capability

Detailed surge current specification (8/20 μs) is indicated as below:

Amplitude	Interval	Quantity
I_{nom}	60 s	15
0.10 I_{max}	30 min	1
0.25 I_{max}	30 min	1
0.50 I_{max}	30 min	1
0.75 I_{max}	30 min	1
1.00 I_{max}	30 min	1

Remark

S20K ... E3K1	$I_{nom} = 5 \text{ kA}$	$I_{max} = 10 \text{ kA}$
---------------	--------------------------	---------------------------

Approvals

- UL

Delivery mode

- Bulk (standard), taped versions on reel upon request.
- For further details refer to chapter "Taping, packaging and lead configuration" for leaded varistors.

General technical data

Climatic category	to IEC 60068-1	40/85/56	
Operating temperature	to CECC 42 000	-40 ... + 85	°C
Storage temperature		-40 ... +125	°C
Electric strength	to CECC 42 000	≥2.5	kV _{RMS}
Response time		<25	ns

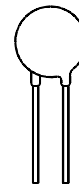
Leaded varistors
SuperioR-MP, S20 series
Maximum ratings ($T_A = 85\text{ °C}$)

Ordering code	Type (untaped) SIOV-	V_{RMS} V	V_{DC} V	i_{max} (8/20 μ s) A	W_{max} (2 ms) J	P_{max} W
B72220S3271K105	S20K275E3K1	275	350	12000	260	1.00
B72220S3301K105	S20K300E3K1	300	385	12000	290	1.00
B72220S3321K105	S20K320E3K1	320	420	12000	320	1.00
B72220S3381K105	S20K385E3K1	385	505	12000	320	1.00
B72220S3421K105	S20K420E3K1	420	560	12000	320	1.00
B72220S3461K105	S20K460E3K1	460	615	12000	370	1.00

Characteristics ($T_A = 25\text{ °C}$)

Ordering code	Type (untaped) SIOV-	V_v (1 mA) V	ΔV_v (1 mA) %	$V_{c, max}$ (i_c) V	i_c A	C_{typ} (1 kHz) pF
B72220S3271K105	S20K275E3K1	430	± 10	710	100	750
B72220S3301K105	S20K300E3K1	470	± 10	775	100	690
B72220S3321K105	S20K320E3K1	510	± 10	840	100	640
B72220S3381K105	S20K385E3K1	620	± 10	1025	100	510
B72220S3421K105	S20K420E3K1	680	± 10	1120	100	475
B72220S3461K105	S20K460E3K1	750	± 10	1240	100	430

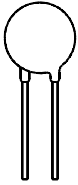

Leaded varistors
SuperioR-MP, S20 series

Dimensional drawing

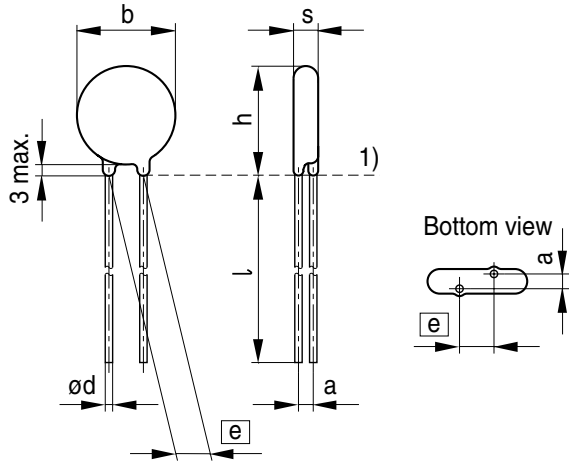

1) Seating plane to IEC 60717

VAR0408-C

Weight

Nominal diameter mm	V_{RMS} V	Weight g
20	275 ... 460	5.5 ... 8.8

The weight of varistors in between these voltage classes can be interpolated.

Dimensions

Ordering code	$e \pm 1$ mm	$a \pm 1$ mm	b_{max} mm	s_{max} mm	h_{max} mm	l_{min} mm	$d \pm 0.05$ mm
B72220S3271K105	10.0	3.5	22.5	6.5	27.0	25.0	1.0
B72220S3301K105	10.0	3.8	22.5	6.8	27.0	25.0	1.0
B72220S3321K105	10.0	3.9	22.5	6.9	27.0	25.0	1.0
B72220S3381K105	10.0	4.8	22.5	8.3	27.5	25.0	1.0
B72220S3421K105	10.0	5.0	22.5	8.6	27.5	25.0	1.0
B72220S3461K105	10.0	5.3	22.5	8.9	27.5	25.0	1.0

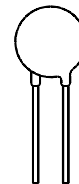
Reliability data

Test	Test methods/conditions	Requirement
Varistor voltage	The voltage between two terminals with the specified measuring current applied is called V_V (1 mA _{DC} @ 0.2 ... 2 s).	To meet the specified value.
Clamping voltage	The maximum voltage between two terminals with the specified standard impulse current (8/20 μ s) applied.	To meet the specified value.
Surge current derating, 8/20 μ s	CECC 42 000, test C 2.1 100 surge currents (8/20 μ s), unipolar, interval 30 s, amplitude corresponding to derating curve for 100 impulses at 20 μ s	$ \Delta V/V (1 \text{ mA}) \leq 10\%$ (measured in direction of surge current) No visible damage
Surge current derating, 2 ms	CECC 42 000, test C 2.1 100 surge currents (2 ms), unipolar, interval 120 s, amplitude corresponding to derating curve for 100 impulses at 2 ms	$ \Delta V/V (1 \text{ mA}) \leq 10\%$ (measured in direction of surge current) No visible damage

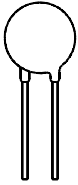

Leaded varistors
SuperioR-MP, S20 series

v/i characteristics

$v = f(i)$ – for explanation of the characteristics refer to “General technical information”, 1.6.3
 A = Leakage current { for worst-case
 B = Protection level { varistor tolerances

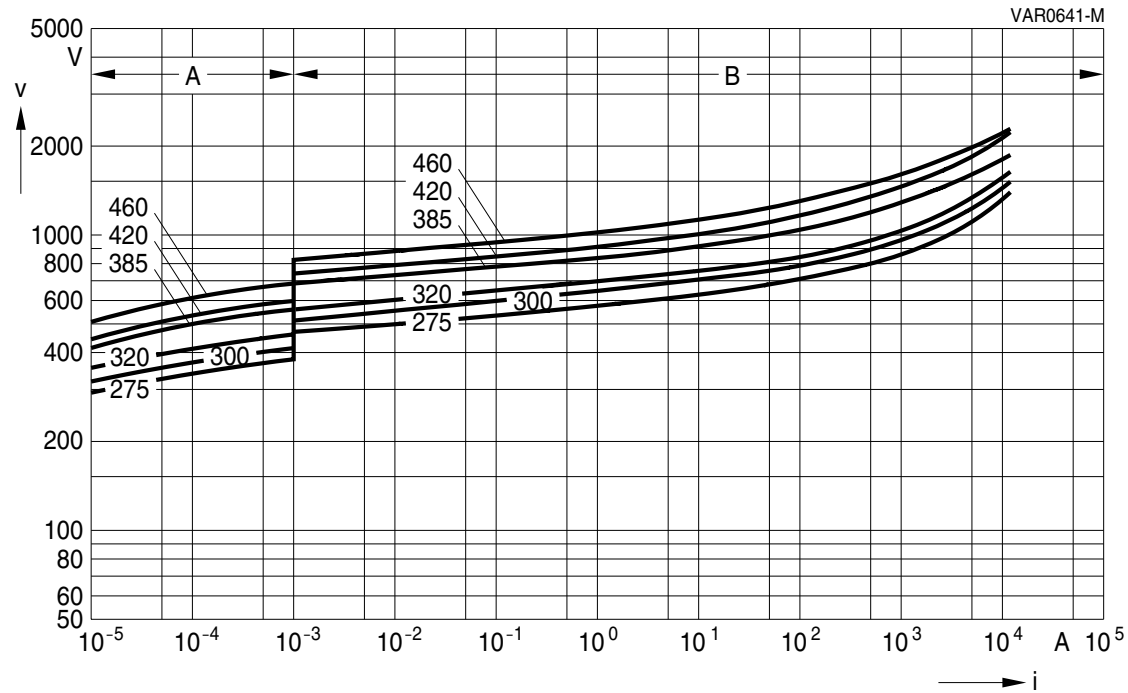

SIOV-S20 ... E3K1

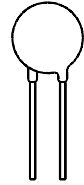

Leaded varistors
SuperioR-MP, S20 series

Derating curves

Maximum surge current $i_{max} = f(t_r, \text{pulse train})$

For explanation of the derating curves refer to "General technical information", section 1.8.1

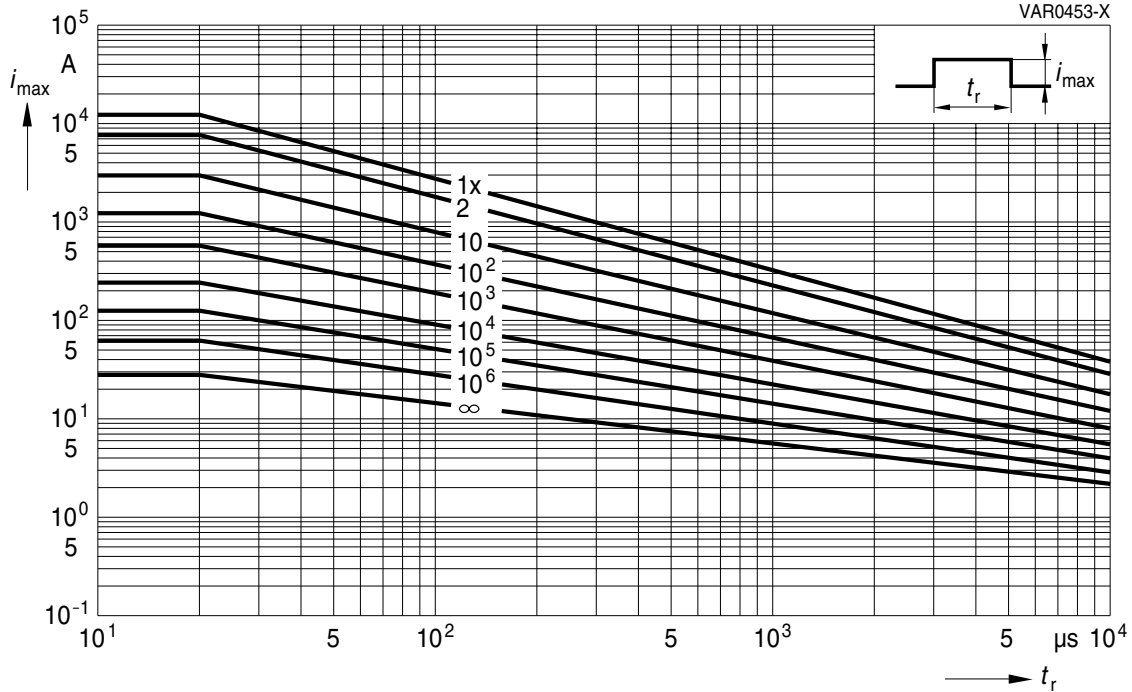

SIOV-S20 ... E3K1

Cautions and warnings

General

1. EPCOS metal oxide varistors (SIOVs) are designed for specific applications and should not be used for purposes not identified in our specifications, application notes and data books unless otherwise agreed with EPCOS during the design-in-phase.
2. Ensure suitability of SIOVs through reliability testing during the design-in phase. SIOVs should be evaluated taking into consideration worst-case conditions.
3. For applications of SIOVs in line-to-ground circuits based on various international and local standards there are restrictions existing or additional safety measures required.

Storage

1. Store SIOVs only in original packaging. Do not open the package before storage.
2. Storage conditions in original packaging:
Storage temperature: $-25\text{ °C} \dots +45\text{ °C}$
Relative humidity: $<75\%$ annual average,
 $<95\%$ on maximum 30 days a year.
Dew precipitation: Is to be avoided.
3. Avoid contamination of an SIOV's surface during storage, handling and processing.
4. Avoid storage of SIOVs in harmful environments that can affect the function during long-term operation (examples given under operation precautions).
5. The SIOV type series should be soldered within the time specified:
SIOV-S, -Q, -LS 24 months
ETFV and SFS types 12 months.

Handling

1. SIOVs must not be dropped.
2. Components must not be touched with bare hands. Gloves are recommended.
3. Avoid contamination of the surface of SIOV electrodes during handling, be careful of the sharp edge of SIOV electrodes.

Soldering (where applicable)

1. Use rosin-type flux or non-activated flux.
2. Insufficient preheating may cause ceramic cracks.
3. Rapid cooling by dipping in solvent is not recommended.
4. Complete removal of flux is recommended.

Leaded varistors

SuperioR-MP, S20 series

Mounting

1. Potting, sealing or adhesive compounds can produce chemical reactions in the SIOV ceramic that will degrade the component's electrical characteristics.
2. Overloading SIOVs may result in ruptured packages and expulsion of hot materials. For this reason SIOVs should be physically shielded from adjacent components.

Operation

1. Use SIOVs only within the specified temperature operating range.
2. Use SIOVs only within the specified voltage and current ranges.
3. Environmental conditions must not harm SIOVs. Use SIOVs only in normal atmospheric conditions. Avoid use in the presence of deoxidizing gases (chlorine gas, hydrogen sulfide gas, ammonia gas, sulfuric acid gas, etc), corrosive agents, humid or salty conditions. Avoid contact with any liquids and solvents.

Important notes

The following applies to all products named in this publication:

1. Some parts of this publication contain **statements about the suitability of our products for certain areas of application**. These statements are based on our knowledge of typical requirements that are often placed on our products in the areas of application concerned. We nevertheless expressly point out **that such statements cannot be regarded as binding statements about the suitability of our products for a particular customer application**. As a rule, EPCOS is either unfamiliar with individual customer applications or less familiar with them than the customers themselves. For these reasons, it is always ultimately incumbent on the customer to check and decide whether an EPCOS product with the properties described in the product specification is suitable for use in a particular customer application.
2. We also point out that **in individual cases, a malfunction of passive electronic components or failure before the end of their usual service life cannot be completely ruled out in the current state of the art, even if they are operated as specified**. In customer applications requiring a very high level of operational safety and especially in customer applications in which the malfunction or failure of a passive electronic component could endanger human life or health (e.g. in accident prevention or life-saving systems), it must therefore be ensured by means of suitable design of the customer application or other action taken by the customer (e.g. installation of protective circuitry or redundancy) that no injury or damage is sustained by third parties in the event of malfunction or failure of a passive electronic component.
3. **The warnings, cautions and product-specific notes must be observed.**
4. In order to satisfy certain technical requirements, **some of the products described in this publication may contain substances subject to restrictions in certain jurisdictions (e.g. because they are classed as hazardous)**. Useful information on this will be found in our Material Data Sheets on the Internet (www.epcos.com/material). Should you have any more detailed questions, please contact our sales offices.
5. We constantly strive to improve our products. Consequently, **the products described in this publication may change from time to time**. The same is true of the corresponding product specifications. Please check therefore to what extent product descriptions and specifications contained in this publication are still applicable before or when you place an order. We also **reserve the right to discontinue production and delivery of products**. Consequently, we cannot guarantee that all products named in this publication will always be available. The aforementioned does not apply in the case of individual agreements deviating from the foregoing for customer-specific products.
6. Unless otherwise agreed in individual contracts, **all orders are subject to the current version of the “General Terms of Delivery for Products and Services in the Electrical Industry” published by the German Electrical and Electronics Industry Association (ZVEI)**.
7. The trade names EPCOS, BAOKE, Alu-X, CeraDiode, CSSP, DSSP, MiniBlue, MKK, MLSC, MotorCap, PCC, PhaseCap, PhaseMod, SIFERRIT, SIFI, SIKOREL, SilverCap, SIMDAD, SIMID, SineFormer, SIOV, SIP5D, SIP5K, ThermoFuse, WindCap are **trademarks registered or pending** in Europe and in other countries. Further information will be found on the Internet at www.epcos.com/trademarks.