

# AFB 50 x 50 x 15 MM SERIES

## DIMENSIONS DRAWING

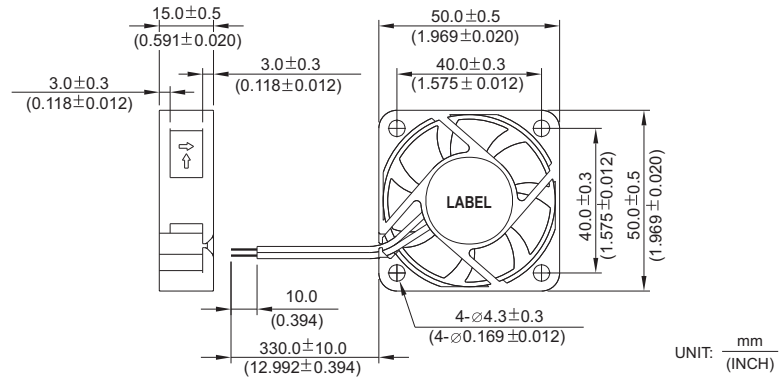

- \* Bearing Type  
Ball Bearings
- \* Material  
Impeller & Frame : Plastic (UL 94V-0)
- \* Lead Wires :  
UL 1007 AWG #24 OR Equivalent  
Red Wire Positive (+)  
Black Wire Negative (-)
- \* Weight : 32g (1.13 oz)
- \* Rib Type Only

## P & Q CURVE (AT RATED VOLTAGE)

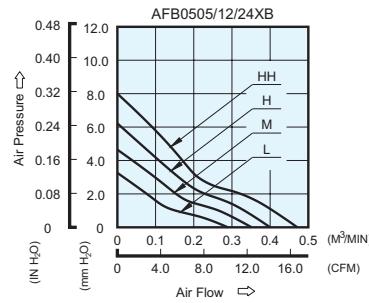

## MOUNTING PANEL CUTOUT

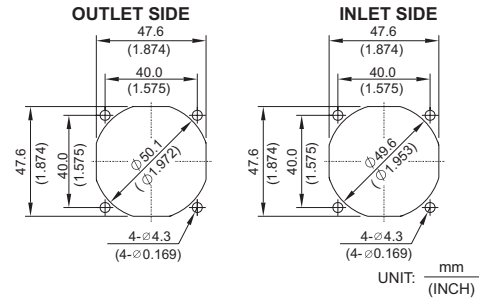

MODEL		Rated Voltage	Operating Voltage Range	Input Current	Input Power	Speed	Maximum Air Flow		Maximum Air Pressure		Noise
PART NO.	FUNCTION	VDC	VDC	Amp	Watt	R.P.M.	m <sup>3</sup> /min	CFM	mmH <sub>2</sub> O	IN H <sub>2</sub> O	dB-A
AFB0505LB	-R00 / -F00	5	4.5 to 5.5	0.15	0.75	4000	0.280	9.89	3.20	0.126	24.0
AFB0512LB	-R00 / -F00	12	7.0 to 13.8	0.06	0.72						
AFB0524LB	-R00 / -F00	24	14.0 to 27.6	0.05	1.20						
AFB0505MB	-R00 / -F00	5	4.5 to 5.5	0.22	1.10	4800	0.350	12.36	4.60	0.181	28.0
AFB0512MB	-R00 / -F00	12	7.0 to 13.8	0.08	0.96						
AFB0524MB	-R00 / -F00	24	14.0 to 27.6	0.06	1.44						
AFB0505HB	-R00 / -F00	5	4.5 to 5.5	0.32	1.60	5600	0.400	14.13	6.10	0.240	32.0
AFB0512HB	-R00 / -F00	12	7.0 to 13.8	0.10	1.20						
AFB0524HB	-R00 / -F00	24	14.0 to 27.6	0.07	1.68						
AFB0512HHB	-R00 / -F00	12	7.0 to 13.8	0.13	1.56	6400	0.460	16.24	8.00	0.315	36.0
AFB0524HHB	-R00 / -F00	24	14.0 to 27.6	0.08	1.92						

\* Function type is optional.  
 \* The max. air flow and the speed are measured in free air ; max. air pressure is measured at zero air flow.  
 \* Noise is measured in anechoic chamber in free air, one meter from intake side.  
 \* All readings are typical values at rated voltage.  
 \* Specifications are subject to change without notice.  
 \* Both of the ball bearing and the 1 ball + 1 sleeve type are available.

*New*



# AFB 50 x 50 x 15 MM SERIES

## DIMENSIONS DRAWING

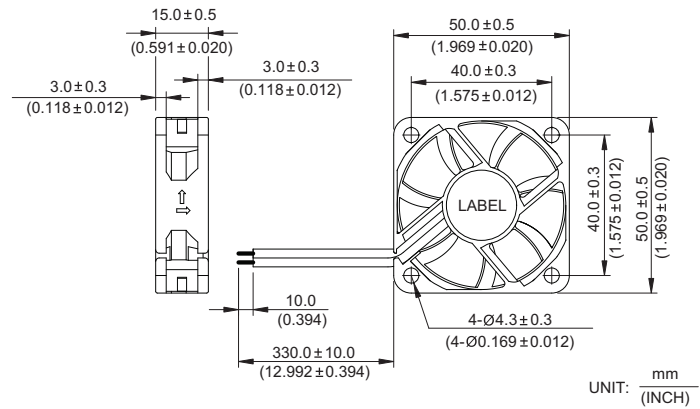

- \* Bearing Type  
Ball Bearings
- \* Material  
Impeller & Frame : Plastic (UL 94V-0)
- \* Lead Wires :  
UL 1007 AWG #24 OR Equivalent  
Red Wire Positive(+)  
Black Wire Negative(-)
- \* Weight : 20 g (0.71 OZ)

## P & Q CURVE (AT RATED VOLTAGE)

## MOUNTING PANEL CUTOUT

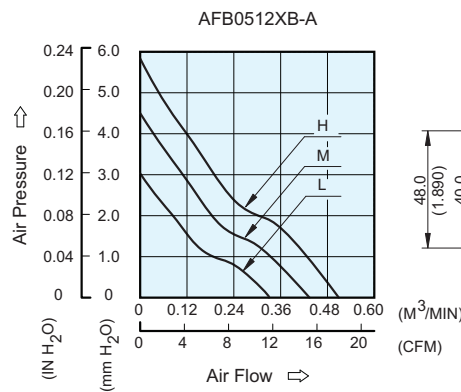

### OUTLET SIDE

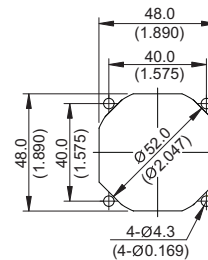

### INLET SIDE

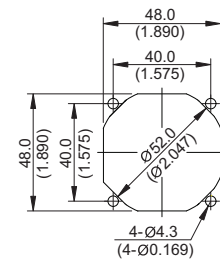

UNIT: mm (INCH)

MODEL			Rated Voltage	Operating Voltage Range	Input Current	Input Power	Speed	Maximum Air Flow		Maximum Air Pressure		Noise
PART NO.	REV	FUNCTION	VDC	VDC	Amp	Watt	R.P.M.	m <sup>3</sup> /min	CFM	mmH <sub>2</sub> O	IN H <sub>2</sub> O	dB-A
AFB0512LB	-A	-R00 / -F00	12	5.0 to 13.8	0.09	1.08	4300	0.330	11.67	3.03	0.119	24.0
AFB0512MB	-A	-R00 / -F00	12	5.0 to 13.8	0.10	1.20	5300	0.434	15.32	4.50	0.177	30.0
AFB0512HB	-A	-R00 / -F00	12	5.0 to 13.8	0.14	1.68	6300	0.509	17.97	5.84	0.230	34.0

\* Rib type only  
 \* The max. air flow and the speed are measured in free air ; max. air pressure is measured at zero air flow.  
 \* Noise is measured in anechoic chamber in free air, one meter from intake side.  
 \* All readings are typical values at rated voltage.  
 \* Specifications are subject to change without notice.