



SANYO Semiconductors

DATA SHEET

An ON Semiconductor Company

Bi-CMOS LSI

LV8740V — PWM Current Control Stepping Motor Driver

Overview

The LV8740V is a 2-channel H-bridge driver IC that can switch a stepping motor driver, which is capable of micro-step drive and supports W 1-2 phase excitation, and two channels of a brushed motor driver, which supports forward, reverse, brake, and standby of a motor. It is ideally suited for driving brushed DC motors and stepping motors used in office equipment and amusement applications.

Features

- Single-channel PWM current control stepping motor driver (selectable with DC motor driver channel 2) incorporated.
- On resistance (upper side : 0.3Ω ; lower side : 0.2Ω ; total of upper and lower : 0.5Ω ; Ta = 25°C, IO = 2.5A)
- Excitation mode can be set to 2-phase, 1-2 phase full torque, 1-2 phase or W1-2 phase
- Excitation step proceeds only by step signal input
- Motor holding current selectable in four steps
- Output short-circuit protection circuit (selectable from latch-type or auto reset-type) incorporated
- Unusual condition warning output pins
- BiCDMOS process IC
- Supports control power supply

Specifications

Absolute Maximum Ratings at Ta = 25°C

Parameter	Symbol	Conditions	Ratings	Unit
Supply voltage 1	V _M max		38	V
Output peak current	I _O peak	tw ≤ 10ms, duty 20%, Each 1ch	3.0	A
Output current	I _O max	Each 1ch	2.5	A
Logic input voltage	V _{IN}		-0.3 to +6.0	V
MONI/EMO input voltage	V _{MONI} /V _{EMO}		-0.3 to +6.0	V
Allowable power dissipation	Pd max	*	3.45	W
Operating temperature	T _{opr}		-30 to +85	°C
Storage temperature	T _{stg}		-55 to +150	°C

* Specified circuit board : 90×90×1.6mm³ : 2-Layer glass epoxy printed circuit board with back mounting.

- Any and all SANYO Semiconductor Co.,Ltd. products described or contained herein are, with regard to "standard application", intended for the use as general electronics equipment (home appliances, AV equipment, communication device, office equipment, industrial equipment etc.). The products mentioned herein shall not be intended for use for any "special application" (medical equipment whose purpose is to sustain life, aerospace instrument, nuclear control device, burning appliances, transportation machine, traffic signal system, safety equipment etc.) that shall require extremely high level of reliability and can directly threaten human lives in case of failure or malfunction of the product or may cause harm to human bodies, nor shall they grant any guarantee thereof. If you should intend to use our products for applications outside the standard applications of our customer who is considering such use and/or outside the scope of our intended standard applications, please consult with us prior to the intended use. If there is no consultation or inquiry before the intended use, our customer shall be solely responsible for the use.
- Specifications of any and all SANYO Semiconductor Co.,Ltd. products described or contained herein stipulate the performance, characteristics, and functions of the described products in the independent state, and are not guarantees of the performance, characteristics, and functions of the described products as mounted in the customer's products or equipment. To verify symptoms and states that cannot be evaluated in an independent device, the customer should always evaluate and test devices mounted in the customer's products or equipment.

SANYO Semiconductor Co., Ltd.

<http://semicon.sanyo.com/en/network>

N1010 SY 20101015-S00001 No.A1864-1/23

LV8740V

Recommended Operating Conditions at Ta = 25°C

Parameter	Symbol	Conditions	Ratings	Unit
Supply voltage range	V _M		9 to 35	V
Logic input voltage	V _{IN}		0 to 5.5	V
VREF input voltage range	VREF		0 to 3.0	V

Electrical Characteristics at Ta = 25°C, V_M = 24V, VREF = 1.5V

Parameter	Symbol	Conditions	Ratings			Unit	
			min	typ	max		
Standby mode current drain 1	IMstn	ST = "L"		180	250	μA	
Current drain	IM	ST = "H", OE = "L", no load		3	5	mA	
VREG5 output voltage	Vreg5	I _O = -1mA	4.7	5.0	5.3	V	
Thermal shutdown temperature	TSD	Design guarantee	150	180	210	°C	
Thermal hysteresis width	ΔTSD	Design guarantee		40		°C	
Motor Driver							
Output on-resistance	Ron _u	I _O = 2.5A, Upper-side on resistance		0.3	0.4	Ω	
	Ron _d	I _O = 2.5A, Lower-side on resistance		0.2	0.25	Ω	
Output leakage current	I _O leak				50	μA	
Diode forward voltage	VD	ID = -2.5A		1.1	1.3	V	
ST pin input current	I _{STL}	V _{IN} = 0.8V	3	8	15	μA	
	I _{STH}	V _{IN} = 5V	48	80	112	μA	
Logic pin input current (other ST pin)	I _{INL}	V _{IN} = 0.8V	3	8	15	μA	
	I _{INH}	V _{IN} = 5V	30	50	70	μA	
Logic high-level input voltage	V _{INH}		2.0			V	
Logic low-level input voltage	V _{INL}				0.8	V	
Current selection comparator threshold voltage (Current step switch)	W1-2-phase drive	Vtdac0_W	Step 0(When initialized : channel 1 comparator level)	0.290	0.300	0.310	V
		Vtdac1_W	Step 1 (Initial state+1)	0.260	0.270	0.280	V
		Vtdac2_W	Step 2 (Initial state+2)	0.200	0.210	0.220	V
		Vtdac3_W	Step 3 (Initial state+3)	0.095	0.105	0.115	V
	1-2 phase drive	Vtdac0_H	Step 0 (When initialized: channel 1 comparator level)	0.290	0.300	0.310	V
		Vtdac2_H	Step 2 (Initial state+1)	0.200	0.210	0.220	V
	1-2 phase (full torque) drive	Vtdac0_HF	Step 0 (Initial state, channel 1 comparator level)	0.290	0.300	0.310	V
		Vtdac2_HF	Step 2 (Initial state+1)	0.290	0.300	0.310	V
	2 phase drive	Vtdac2_F	Step 2	0.290	0.300	0.310	V
	Current selection comparator threshold voltage (Current attenuation rate switch)	Vtatt00	ATT1=L, ATT2=L	0.290	0.300	0.310	V
Vtatt01		ATT1=H, ATT2=L	0.190	0.200	0.210	V	
Vtatt10		ATT1=L, ATT2=H	0.140	0.150	0.160	V	
Vtatt11		ATT1=H, ATT2=H	0.090	0.100	0.110	V	
Chopping frequency	Fchop	RCHOP = 20kΩ	45	62.5	75	kHz	
VREF pin input current	Iref	VREF = 1.5V	-0.5			μA	
MONI pin saturation voltage	Vsatmon	I _{MONI} = 1mA		50	100	mV	
Charge pump							
VG output voltage	VG		28	28.7	29.8	V	
Rise time	tONG	VG = 0.1μF			0.5	ms	
Oscillator frequency	Fosc	RCHOP = 20kΩ	90	125	150	kHz	
Output short-circuit protection							
EMO pin saturation voltage	Vsatemo	I _{emo} = 1mA		50	100	mV	
CEM pin charge current	Icem	Vcem = 0V	7	10	13	μA	
CEM pin threshold voltage	Vtciem		0.8	1.0	1.2	V	

LV8740V

Package Dimensions

unit : mm (typ)

3285A

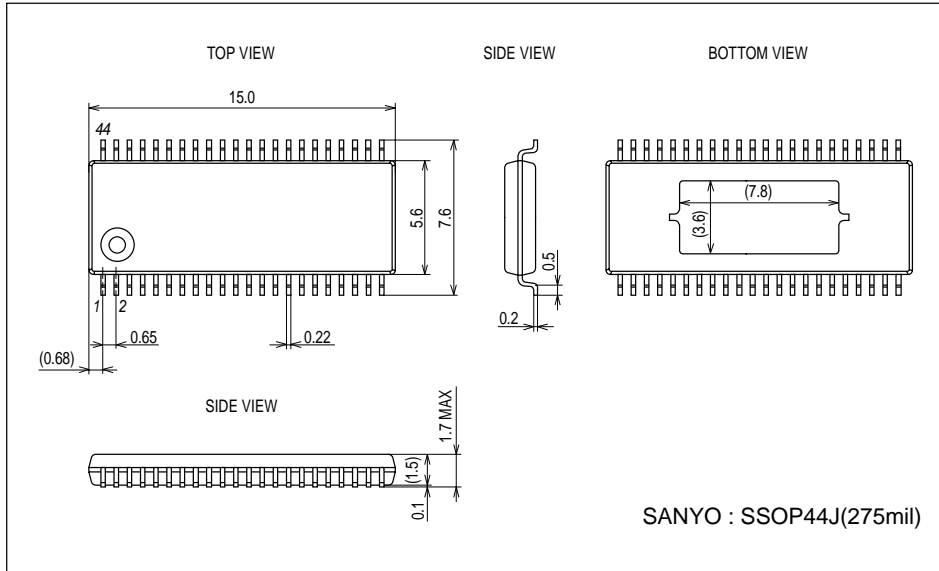

Pin Assignment

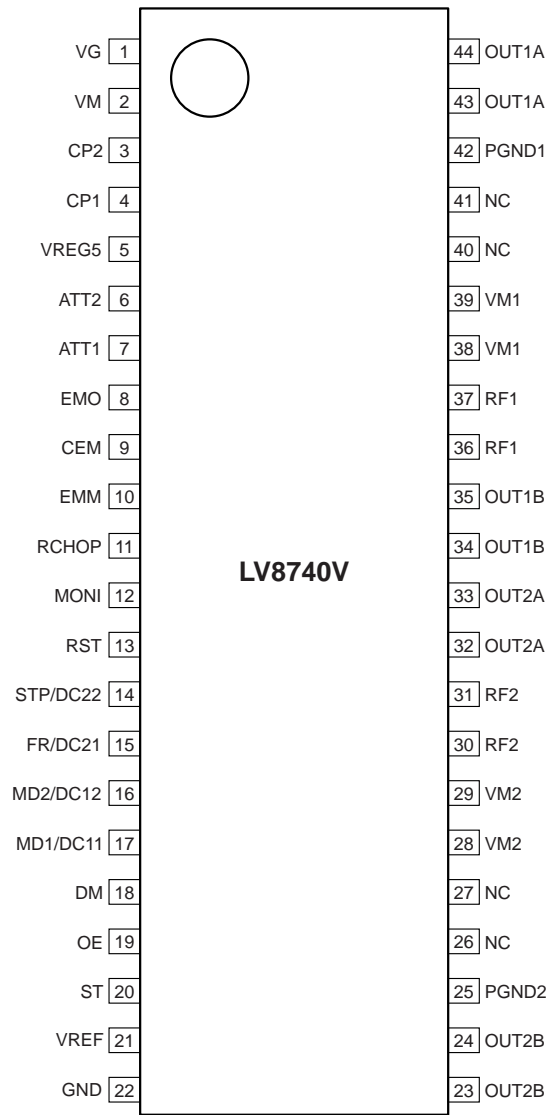

Top view

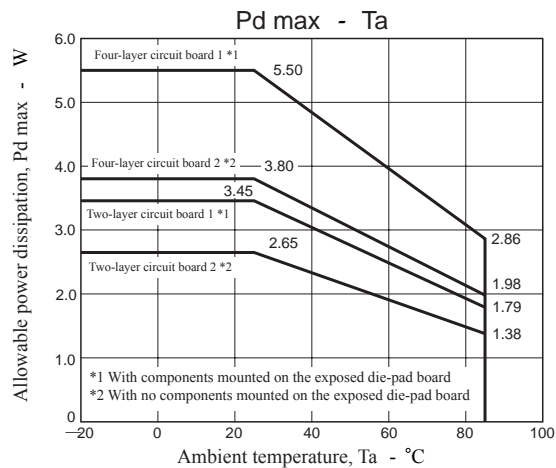

Substrate Specifications (Substrate recommended for operation of LV8740V)

Size : 90mm × 90mm × 1.6mm
 Material : Glass epoxy
 Copper wiring density : L1 = 85% / L2 = 90%

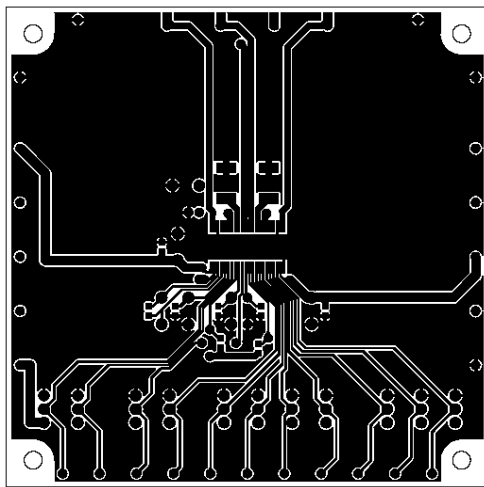

L1 : Copper wiring pattern diagram

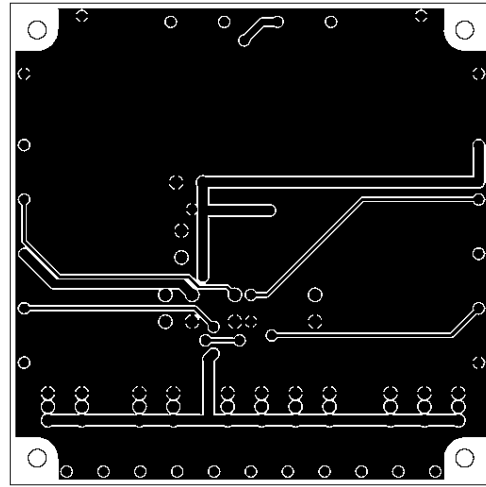

L2 : Copper wiring pattern diagram

Cautions

- 1) The data for the case with the Exposed Die-Pad substrate mounted shows the values when 90% or more of the Exposed Die-Pad is wet.
- 2) For the set design, employ the derating design with sufficient margin.
 Stresses to be derated include the voltage, current, junction temperature, power loss, and mechanical stresses such as vibration, impact, and tension.
 Accordingly, the design must ensure these stresses to be as low or small as possible.
 The guideline for ordinary derating is shown below :
 - (1) Maximum value 80% or less for the voltage rating
 - (2) Maximum value 80% or less for the current rating
 - (3) Maximum value 80% or less for the temperature rating
- 3) After the set design, be sure to verify the design with the actual product.
 Confirm the solder joint state and verify also the reliability of solder joint for the Exposed Die-Pad, etc.
 Any void or deterioration, if observed in the solder joint of these parts, causes deteriorated thermal conduction, possibly resulting in thermal destruction of IC.

Block Diagram

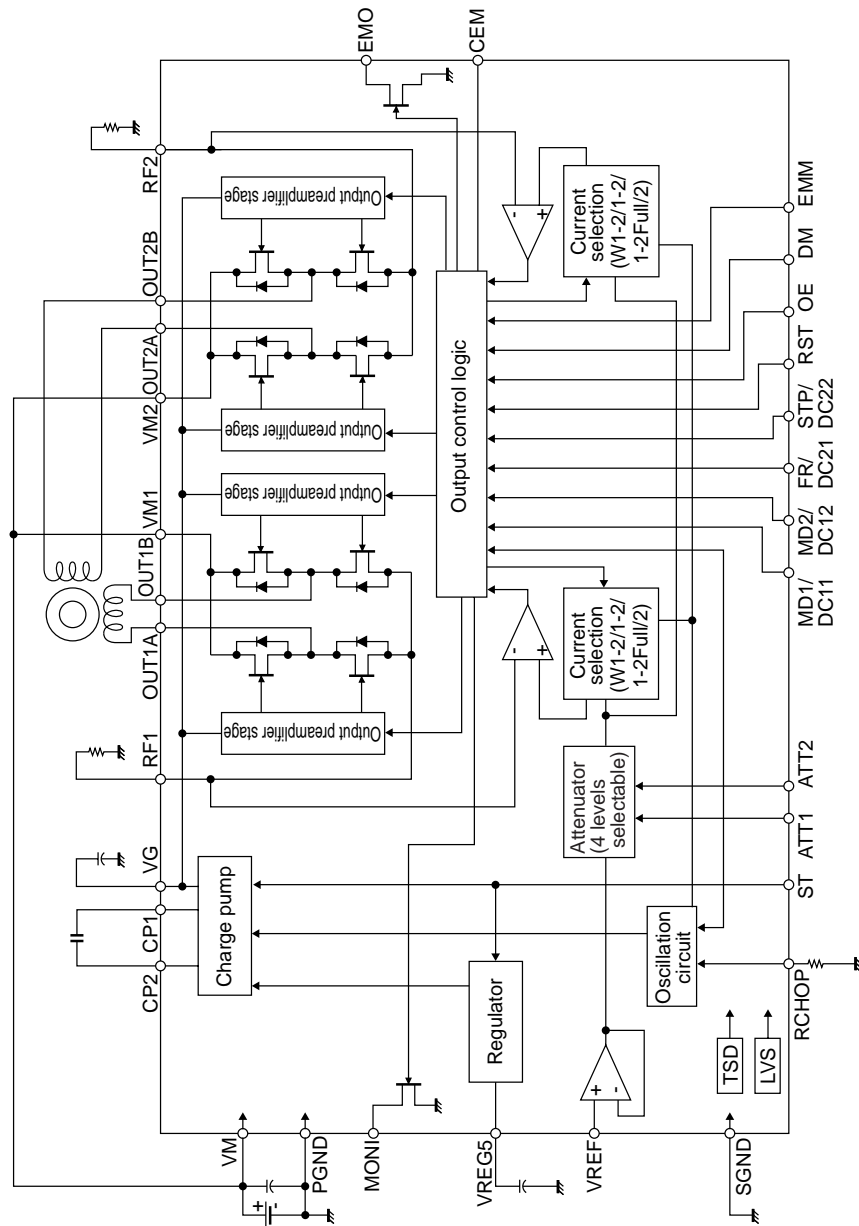

LV8740V

Pin Functions

Pin No.	Pin name	Description
1	VG	Charge pump capacitor connection pin
2	VM	Motor power supply connection pin
3	CP2	Charge pump capacitor connection pin
4	CP1	Charge pump capacitor connection pin
5	VREG5	Internal power supply capacitor connection pin
6	ATT2	Motor holding current switching pin
7	ATT1	Motor holding current switching pin
8	EMO	Output short-circuit state warning output pin
9	CEM	Pin to connect the output short-circuit state detection time setting capacitor
10	EMM	Overcurrent mode switching pin
11	RCHOP	Chopping frequency setting resistor connection pin
12	MONI	Position detection monitor pin
13	RST	Reset signal input pin
14	STP/DC22	STM STEP signal input pin/DCM2 output control input pin
15	FR/DC21	STM forward/reverse rotation signal input pin/DCM2 output control input pin
16	MD2/DC12	STM excitation mode switching pin/DCM1 output control input pin
17	MD1/DC11	STM excitation mode switching pin/DCM1 output control input pin
18	DM	Drive mode (STM/DCM) switching pin
19	OE	Output enable signal input pin
20	ST	Chip enable pin
21	VREF	Constant current control reference voltage input pin
22	SGND	Signal system ground
23, 24	OUT2B	Channel 2 OUTB output pin
25	PGND2	Channel 2 Power system ground
28, 29	VM2	Channel 2 motor power supply connection pin
30, 31	RF2	Channel 2 current-sense resistor connection pin
32, 33	OUT2A	Channel 2 OUTA output pin
34, 35	OUT1B	Channel 1 OUTB output pin
36, 37	RF1	Channel 1 current-sense resistor connection pin
38, 39	VM1	Channel 1 motor power supply pin
42	PGND1	Channel 1 Power system ground
43, 44	OUT1A	Channel 1 OUTA output pin
26, 27 40, 41	NC	No Connection (No internal connection to the IC)

LV8740V

Equivalent Circuits

Pin No.	Pin	Equivalent Circuit
6 7 10 13 14 15 16 17 18 19	ATT2 ATT1 EMM RST STP/DC22 FR/DC21 MD2/DC12 MD1/DC11 DM OE	
20	ST	
23, 24 25 28, 29 30, 31 32, 33 34, 35 36, 37 38, 39 42 43, 44	OUT2B PGND2 VM2 RF2 OUT2A OUT1B RF1 VM1 PGND1 OUT1A	

Continued on next page.

LV8740V

Continued from preceding page.

Pin No.	Pin	Equivalent Circuit
1 2 3 4	VG VM CP2 CP1	
21	VREF	
5	VREG5	
8 12	EMO MONI	

Continued on next page.

LV8740V

Continued from preceding page.

Pin No.	Pin	Equivalent Circuit
9	CEM	
11	RCHOP	

Input Pin Function

(1) Chip enable function

This IC is switched between standby and operating mode by setting the ST pin. In standby mode, the IC is set to power-save mode and all logic is reset. In addition, the internal regulator circuit and charge pump circuit do not operate in standby mode.

ST	Mode	Internal regulator	Charge pump
Low or Open	Standby mode	Standby	Standby
High	Operating mode	Operating	Operating

(2) Drive mode switching pin function



The IC drive mode is switched by setting the DM pin. In STM mode, stepping motor channel 1 can be controlled by the CLK-IN input. In DCM mode, DC motor channel 2 or stepping motor channel 1 can be controlled by parallel input. Stepping motor control using parallel input is 2-phase or 1-2 phase full torque.

DM	Drive mode	Application
Low or Open	STM mode	Stepping motor channel 1 (CLK-IN)
High	DCM mode	DC motor channel 2 or stepping motor channel 1 (parallel)

STM mode (DM = Low or Open)

(1) STEP pin function

The excitation step progresses by inputting the step signal to the STP pin.

Input		Operating mode
ST	STP	
Low	*	Standby mode
High		Excitation step proceeds
High		Excitation step is kept

(2) Excitation mode setting function

The excitation mode of the stepping motor can be set as follows by setting the MD1 pin and the MD2 pin.

MD1	MD2	Excitation mode	Initial position	
			Channel 1	Channel 2
Low	Low	2 phase excitation	100%	-100%
High	Low	1-2 phase excitation (full torque)	100%	0%
Low	High	1-2 phase excitation	100%	0%
High	High	W1-2 phase excitation	100%	0%

This is the initial position of each excitation mode in the initial state after power-on and when the counter is reset.

(3) Positional detection monitor function

Positional detection monitor MONI pin is an open drain output. When the excitation position is an initial position, the MONI output becomes ON.

Please refer to (example of current wave type in each excitation mode).

(4) Constant-current control reference voltage setting function

This IC does the PWM fixed current chopping control of the current of the motor by the automatic operation in setting the output current. The output current in which a fixed current is controlled by the following calculation type is set by the resistance connected between the voltage and RF-GND being input to the VREF pin.

$$I_{OUT} = (V_{REF}/5) / \text{RF resistance}$$

*The above-mentioned, set value is an output current of each excitation mode at 100% time.

VREF input voltage attenuation function

ATT1	ATT2	Current setting reference voltage attenuation ratio
Low	Low	100%
High	Low	66.7%
Low	High	50%
High	High	33.3%

The output ammeter calculation type when the attenuation function of the VREF input voltage is used is as follows.

$$I_{OUT} = (V_{REF}/5) \times (\text{Attenuation ratio}) / R_F \text{ resistance}$$

(Example) When $V_{REF} = 1.5V$, setting current ratio = 100% [(ATT1, ATT2) = (Low, Low)] and R_F resistor = 0.2Ω , the following output current flows :

$$I_{OUT} = 1.5V/5 \times 100\% / 0.2\Omega = 1.5A$$

Under such a condition, when assuming (ATT1, ATT2) = (High, High).

$$I_{OUT} = 1.5A \times 33.3\% = 500mA$$

The power saving can be done, and attenuating the output current when the motor energizes maintenance.

(5) Reset function

RST	Operating mode
Low	Normal operation
High	Reset state

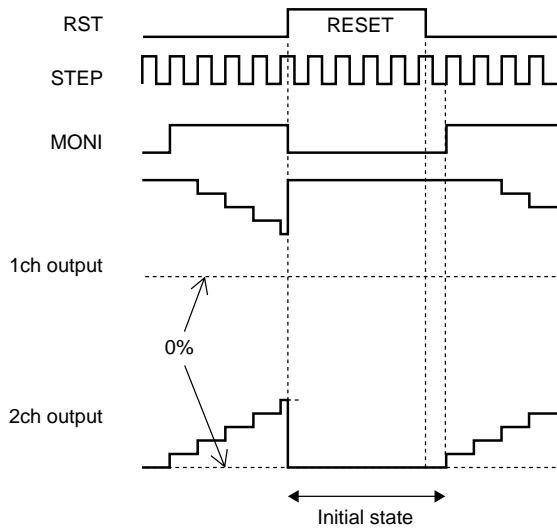

When the RST pin is set High, the output excitation position is forced to the initial state, and the MONI output enters ON a state. When RST is set Low after that, the excitation position proceeds to the next STEP input.

(6) Output enable function

OE	Operating mode
High	Output OFF
Low	Output ON

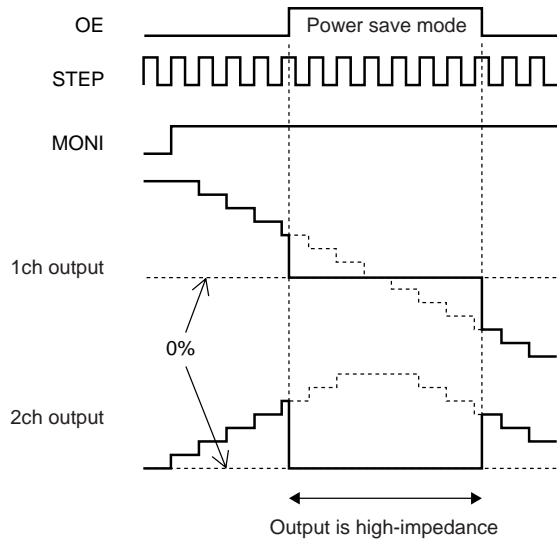

LV8740V

When the OE pin is set High, the output is forced OFF and goes to high impedance. However, the internal logic circuits are operating, so the excitation position proceeds when the STEP signal is input to the STP pin. Therefore, when OE is returned to Low, the output level conforms to the excitation position proceeded by the STEP input.

(7) Forward/reverse switching function

FR	Operating mode
Low	Clockwise (CW)
High	Counter-clockwise (CCW)

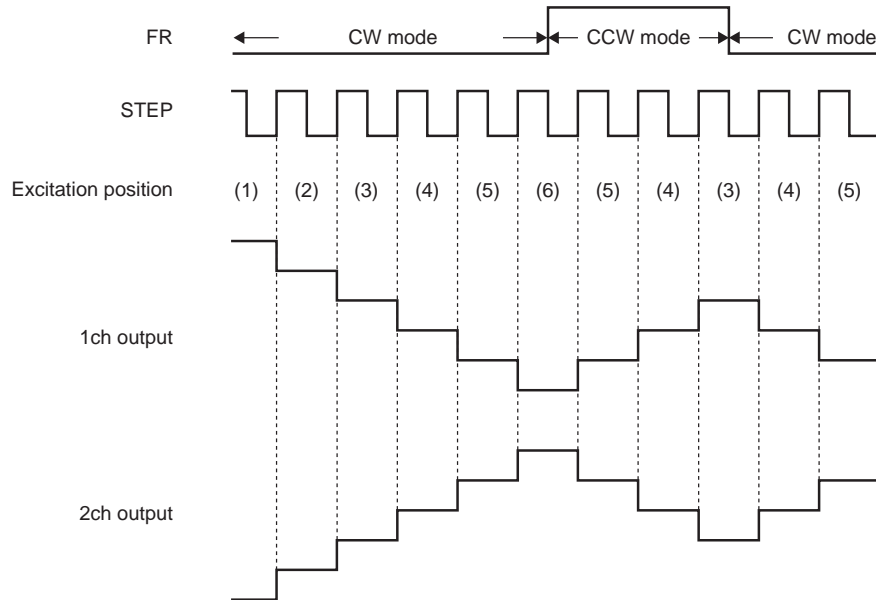

The internal D/A converter proceeds by one bit at the rising edge of the input STEP pulse. In addition, CW and CCW mode are switched by setting the FR pin. In CW mode, the channel 2 current phase is delayed by 90° relative to the channel 1 current. In CCW mode, the channel 2 current phase is advanced by 90° relative to the channel 1 current.

(8) Setting the chopping frequency

For constant-current control, chopping operation is made with the frequency determined by the external resistor (connected to the RCHOP pin).

The chopping frequency to be set with the resistance connected to the RCHOP pin (pin 11) is as shown below.

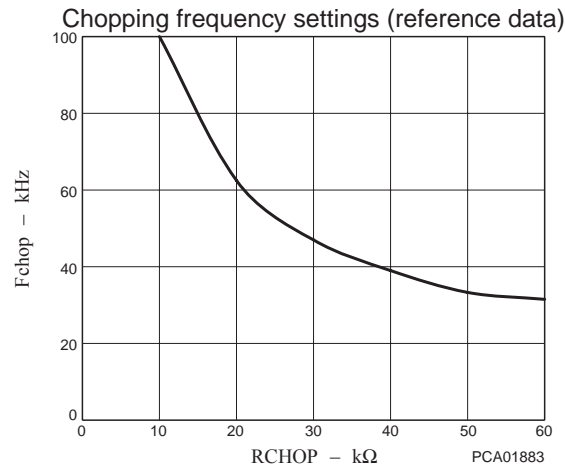

(9) Output current vector locus (one step is normalized to 90 degrees)

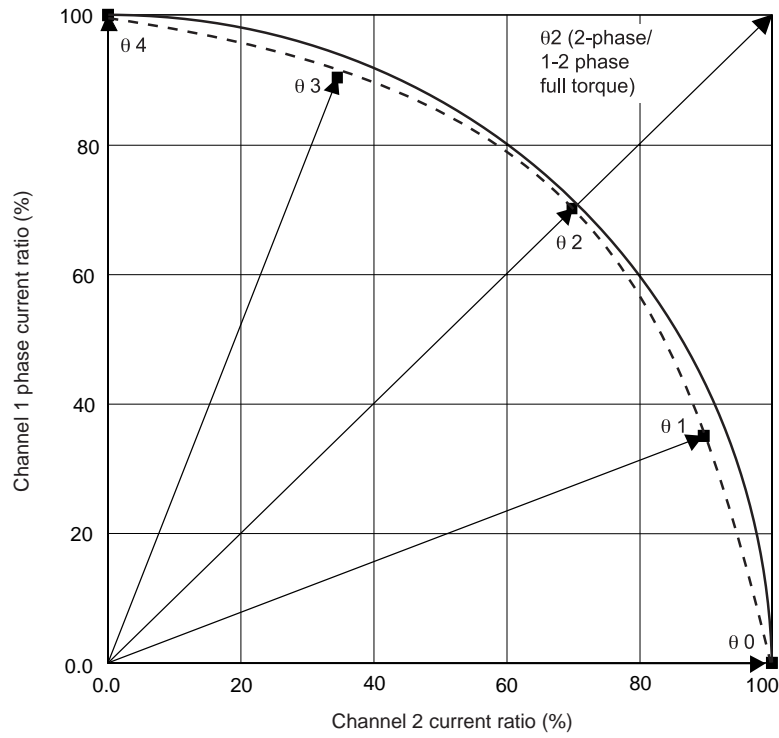

Setting current ration in each excitation mode

STEP	W1-2 phase (%)		1-2 phase (%)		1-2 phase full torque (%)		2-phase (%)	
	Channel 1	Channel 2	Channel 1	Channel 2	Channel 1	Channel 2	Channel 1	Channel 2
$\theta 0$	0	100	0	100	0	100		
$\theta 1$	35	90						
$\theta 2$	70	70	70	70	100	100	100	100
$\theta 3$	90	35						
$\theta 4$	100	0	100	0	100	0		

(10) Typical current waveform in each excitation mode
2-phase excitation (CW mode)

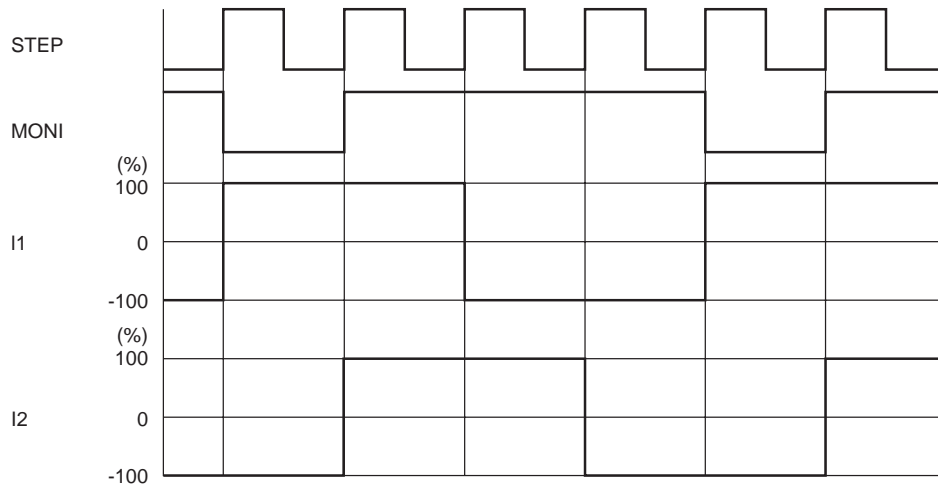

1-2 phase excitation full torque (CW mode)

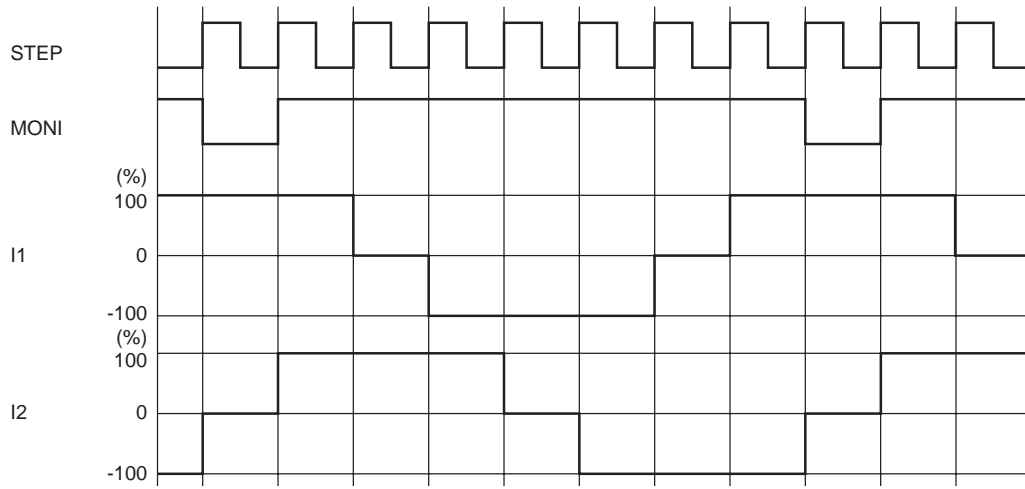

1-2 phase excitation (CW mode)

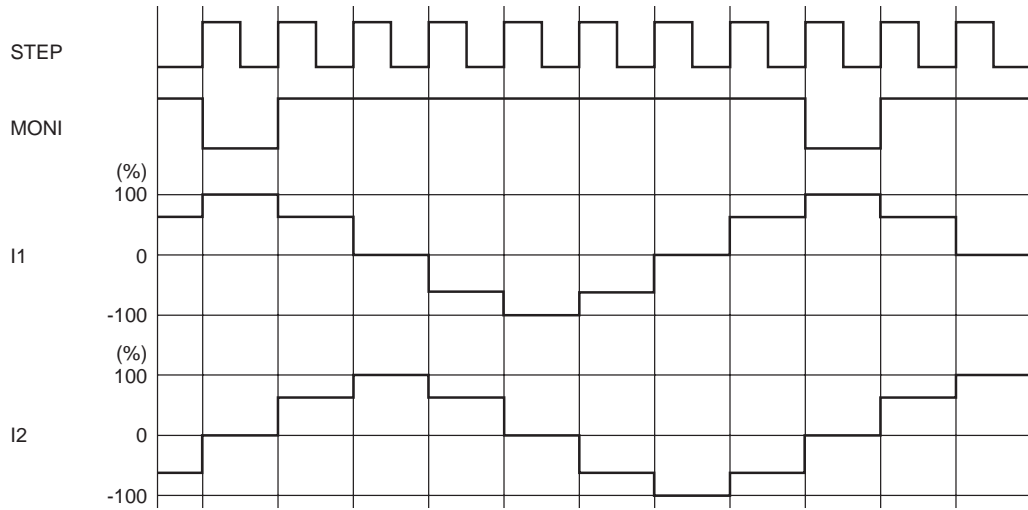

W1-2 phase excitation (CW mode)

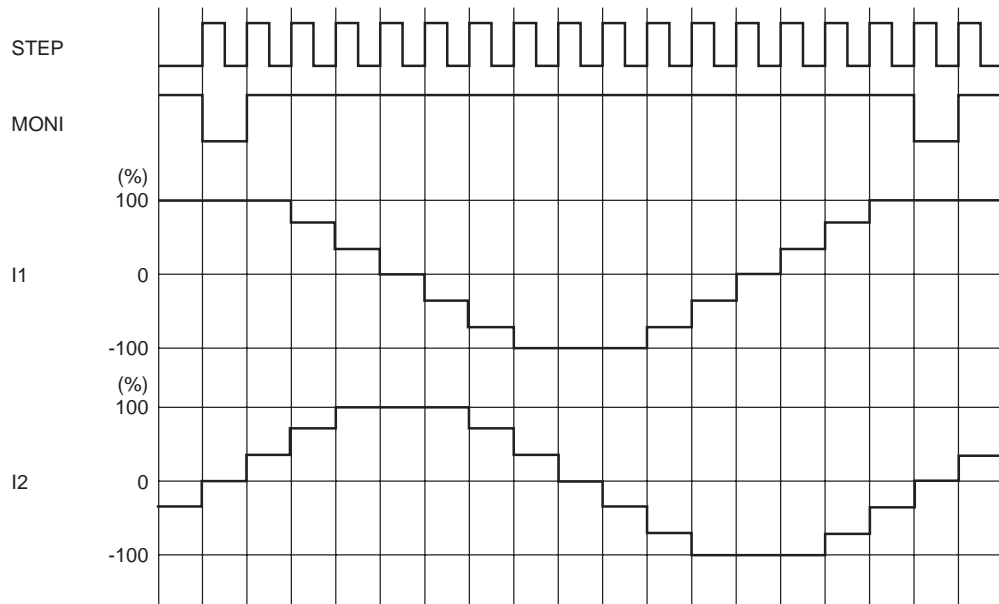

(11) Current control operation specification

(Sine wave increasing direction)

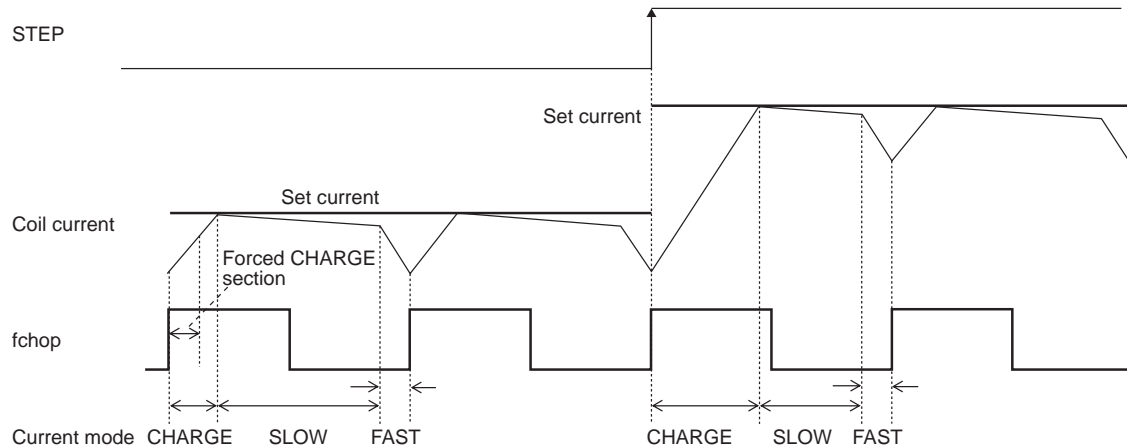

(Sine wave decreasing direction)

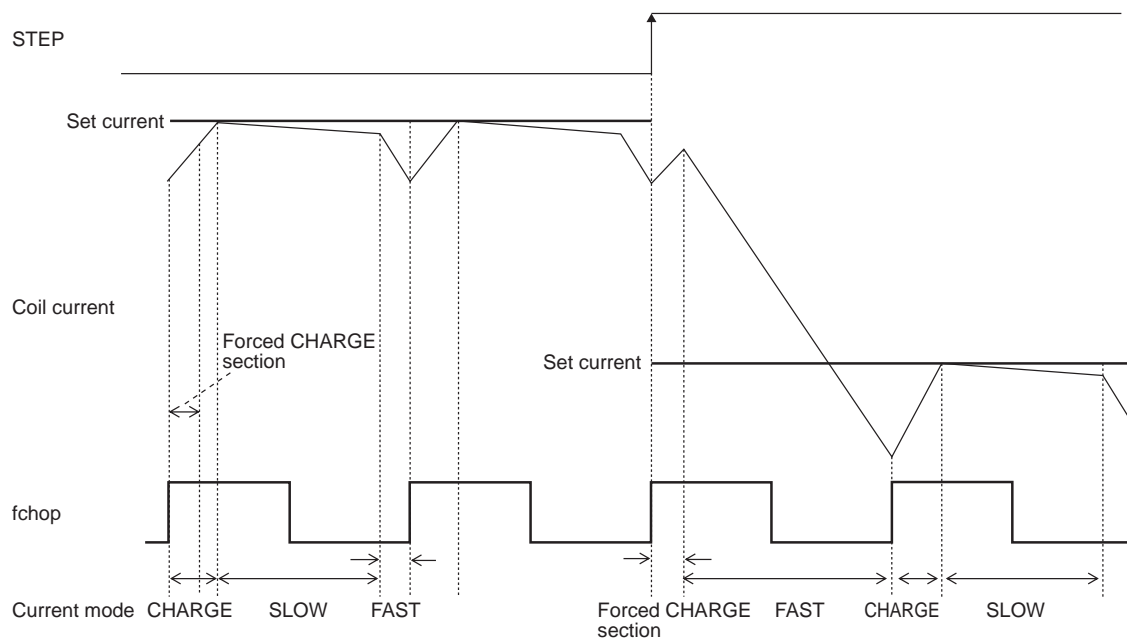

In each current mode, the operation sequence is as described below :

- At rise of chopping frequency, the CHARGE mode begins.(The section in which the CHARGE mode is forced regardless of the magnitude of the coil current (ICOIL) and set current (IREF) exists for 1/16 of one chopping cycle.)
- The coil current (ICOIL) and set current (IREF) are compared in this forced CHARGE section.

When $(ICOIL < IREF)$ state exists in the forced CHARGE section ;

CHARGE mode up to $ICOIL \geq IREF$, then followed by changeover to the SLOW DECAY mode, and finally by the FAST DECAY mode for the 1/16 portion of one chopping cycle.

When $(ICOIL < IREF)$ state does not exist in the forced CHARGE section;

The FAST DECAY mode begins. The coil current is attenuated in the FAST DECAY mode till one cycle of chopping is over.

Above operations are repeated. Normally, the SLOW (+FAST) DECAY mode continues in the sine wave increasing direction, then entering the FAST DECAY mode till the current is attenuated to the set level and followed by the SLOW DECAY mode.

DCM Mode (DM-High)

(1) DCM mode output control logic

Parallel input		Output		Mode
DC11 (21)	DC12 (22)	OUT1 (2) A	OUT1 (2) B	
Low	Low	OFF	OFF	Standby
High	Low	High	Low	CW (Forward)
Low	High	Low	High	CCW (Reverse)
High	High	Low	Low	Brake

(2) Reset function

RST	Operating mode	MONI
High or Low	Reset operation not performed	High output

The reset function does not operate in DCM mode. In addition, the MONI output is High, regardless of the RST pin state.

(3) Output enable function

OE	Operating mode
High	Output OFF
Low	Output ON

When the OE pin is set High, the output is forced OFF and goes to high impedance. When the OE pin is set Low, output conforms to the control logic.

(4) Current limit control time chart

When the current of the motor reaches up to the limit current by setting the current limit, this IC does the short brake control by the automatic operation so that the current should not increase more than it.

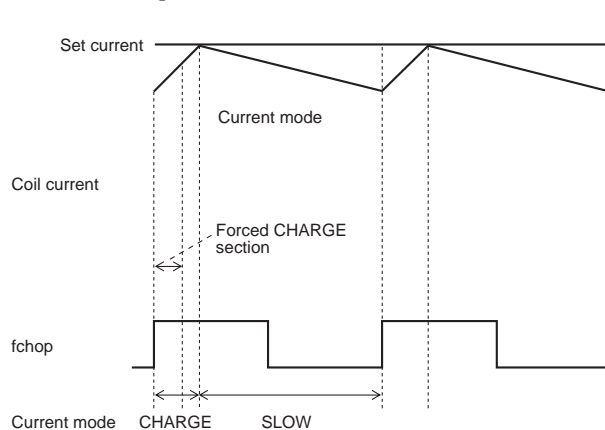

Moreover, the voltage impressed to the terminal VREF can be switched to the setting of four stages by the state of two input of ATT1 and ATT2.

VREF input voltage attenuation function

ATT1	ATT2	Current setting reference voltage
Low	Low	100%
High	Low	66.7%
Low	High	50%
High	High	33.3%

The output ammeter calculation type when the attenuation function of the VREF input voltage is used is as follows.

$$I_{OUT} = (V_{REF}/5) \times (\text{Attenuation ratio}) / R_F \text{ resistance}$$

(Example) When $V_{REF} = 1.5V$, setting current ratio = 100% [(ATT1, ATT2) = (Low, Low)] and R_F resistor = 0.2Ω , the following output current flows :

$$I_{OUT} = 1.5V/5 \times 100\% / 0.2\Omega = 1.5A$$

Under such a condition, when assuming (ATT1, ATT2) = (High, High).

$$I_{OUT} = 1.5A \times 33.3\% = 500mA$$

(5) Typical current waveform in each excitation mode when stepping motor parallel input control
2-phase excitation (CW mode)

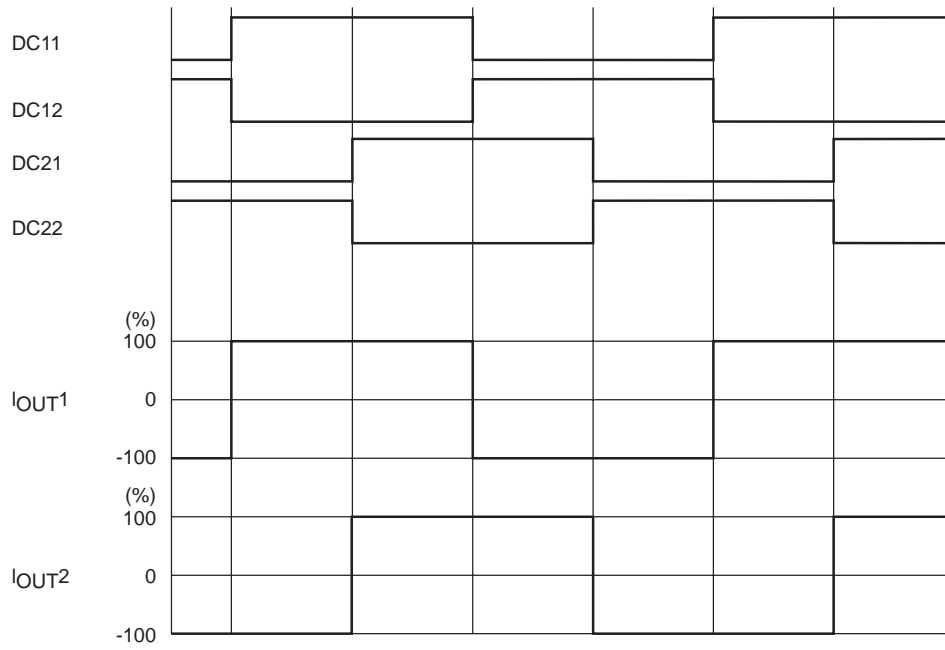

1-2 phase excitation full torque (CW mode)

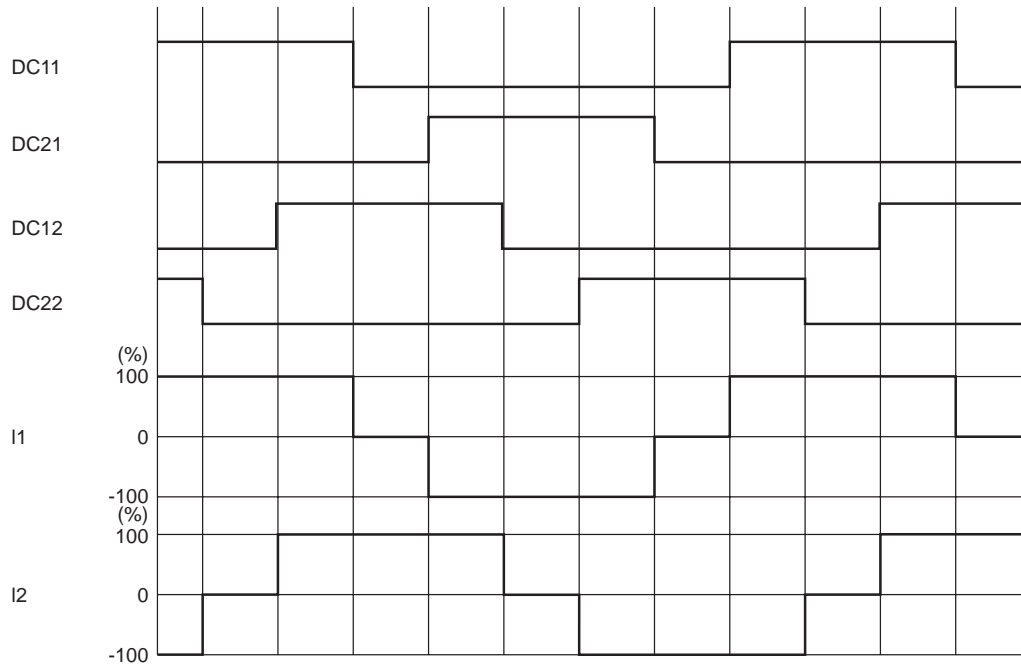

Output short-circuit protection circuit

This output short protection circuit that makes the output a standby mode to prevent the thing that IC destroys when the output is short-circuited by a voltage short and the earth fault, etc. , and turns on the warning output to IC is built into.

(1) Output short-circuit protection operation changeover function

Changeover to the output short-circuit protection of IC is made by the setting of EMM pin.

EMM	State
Low or Open	Latch method
High	Auto reset method

(2) Latch method

In the latch mode, the output is turned off when the output current exceeds the detection current, and the state is maintained.

The output short protection circuit starts operating so that IC may detect a short output. When the short-circuit is the consecutive between internal timers ($\approx 4\mu\text{s}$), the output where the short-circuit is first detected is turned off. Even if the following time (T_{cem}) of the timer latch is exceeded, the output is turned ON again, and afterwards, when the short-circuit is detected, all the outputs of correspondence ch side are still switched to the standby mode, and the state is maintained. This state is released by making it to $ST = "L"$.

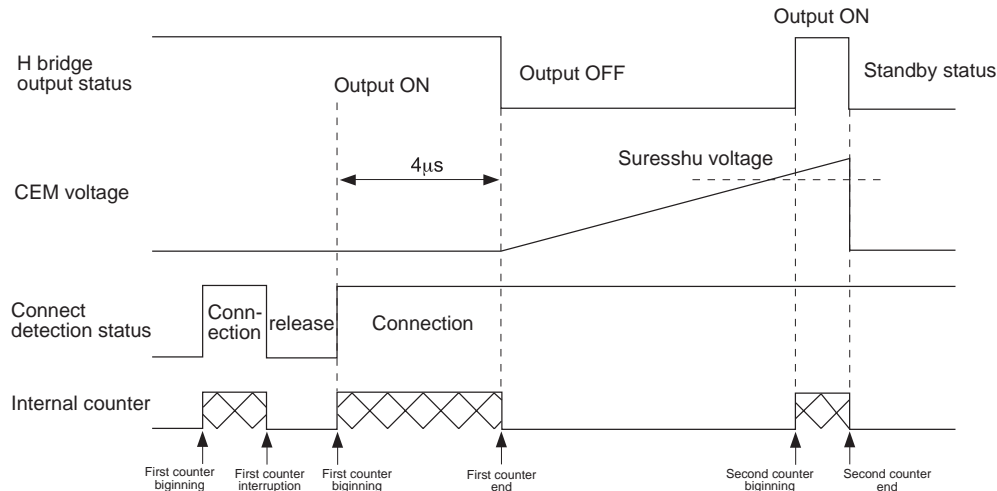

(3) Automatic return method

In the automatic return mode, the output wave type changes into the switching wave type when the output current exceeds the detection current.

The short-circuit detection circuit operates when a short output is detected as well as the latch method. The output is switched to the standby mode when the operation of the short-circuit detection circuit exceeds the following time (T_{cem}) of the timer latch, and it returns to the turning on mode again after 2ms(TYP). At this time, the above-mentioned switching mode is repeated when is still in the overcurrent mode until the overcurrent mode is made clear.

(4) Abnormal state warning output pin

When IC operates the protection circuit detecting abnormality, the EMO pin has been installed as a terminal that outputs this abnormality to CPU side. This pin is an open drain output, and if abnormality is detected, the EMO output becomes (EMO="L") of ON.

EMO pin enters on a state in the following.

- When a voltage short, the earth fault or the load is short-circuited and the output short-circuit protection circuit operates, the output pin
- When the junction temperature of IC rises, and the overheating protection circuit operates

(5) Timer latch time (Tcem)

The time to output OFF when an output short-circuit occurs can be set by the capacitor connected between the CEM pin and GND. The capacitor (Ccem) value can be determined as follows :

Timer latch : Tcem

$$T_{cem} \approx C \times V/I \text{ [sec]}$$

V : Threshold voltage of comparator TYP 1V

I : CEM charge current TYP 10 μ A

Charge Pump Circuit

When the ST pin is set High, the charge pump circuit operates and the VG pin voltage is boosted from the VM voltage to the VM + VREG5 voltage. I will recommend the drive of the motor to put the time of tONG or more after the ST pin is made "H", and to begin because I cannot control the output if there is no pressure voltage of the voltage of the VG pin enough.

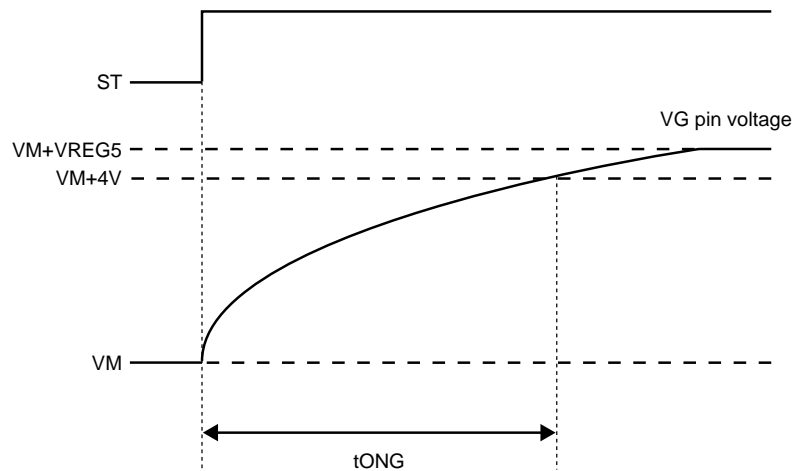

VG Pin Voltage Schematic View

LV8740V

Application Circuits

- Stepping motor driver application circuit example(DM="L")

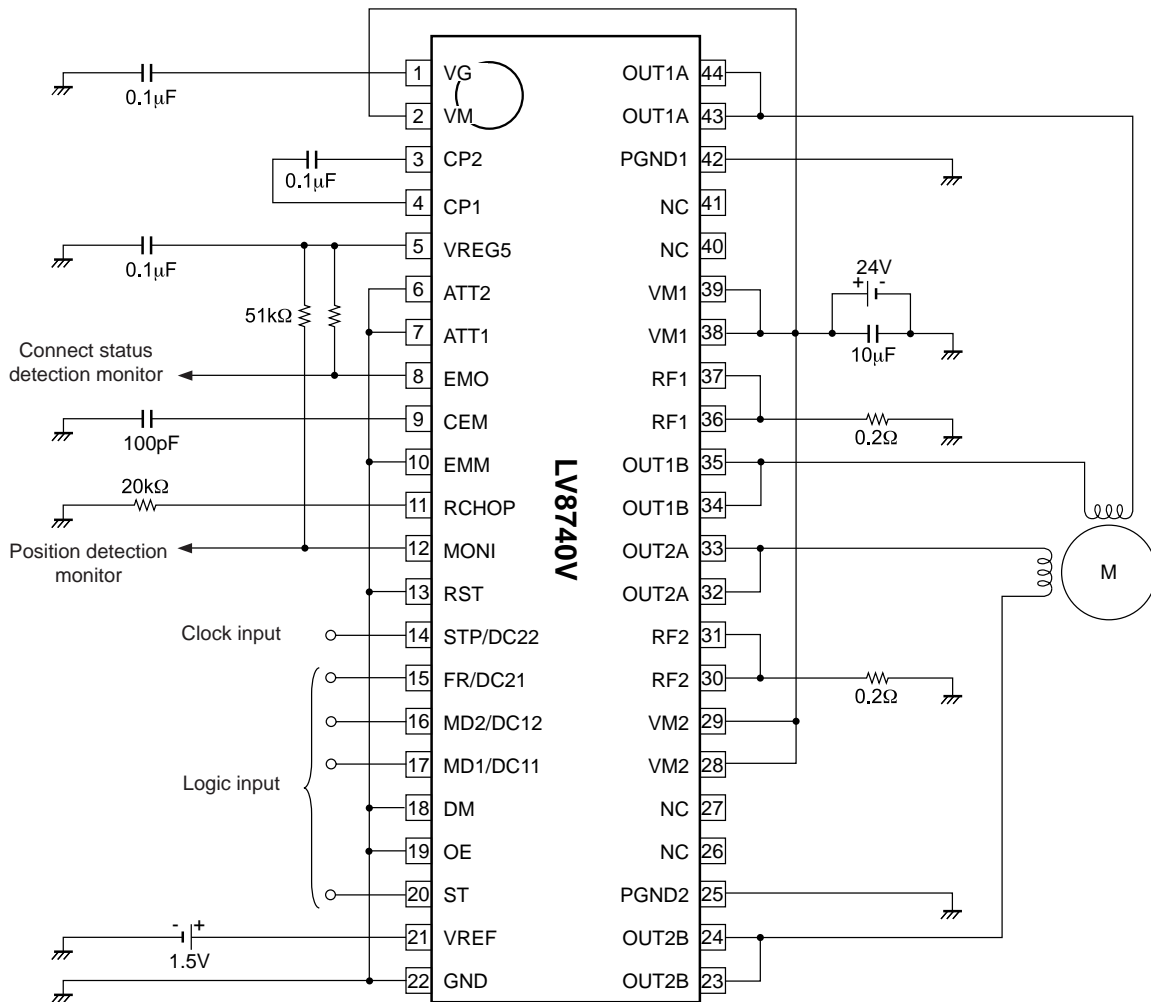

Each constant setting type in the example of the above-mentioned circuit is as follows.
When setting current ratio = 100%, VREF = 1.5V, the following output current flows :

$$I_{OUT} = V_{REF}/5/RF \text{ resistance}$$

$$= 1.5V/5 \times 100\%/0.2\Omega = 1.5A$$

Chopping frequency setting.
62.5kHz (RCHOP=20kΩ)

Time of timer latch when output is short-circuited

$$T_{cem} = C_{cem} * V_{tcem}/I_{cem}$$

$$= 100pF * 1V/10\mu A = 10\mu s$$

LV8740V

- DC motor driver application circuit example

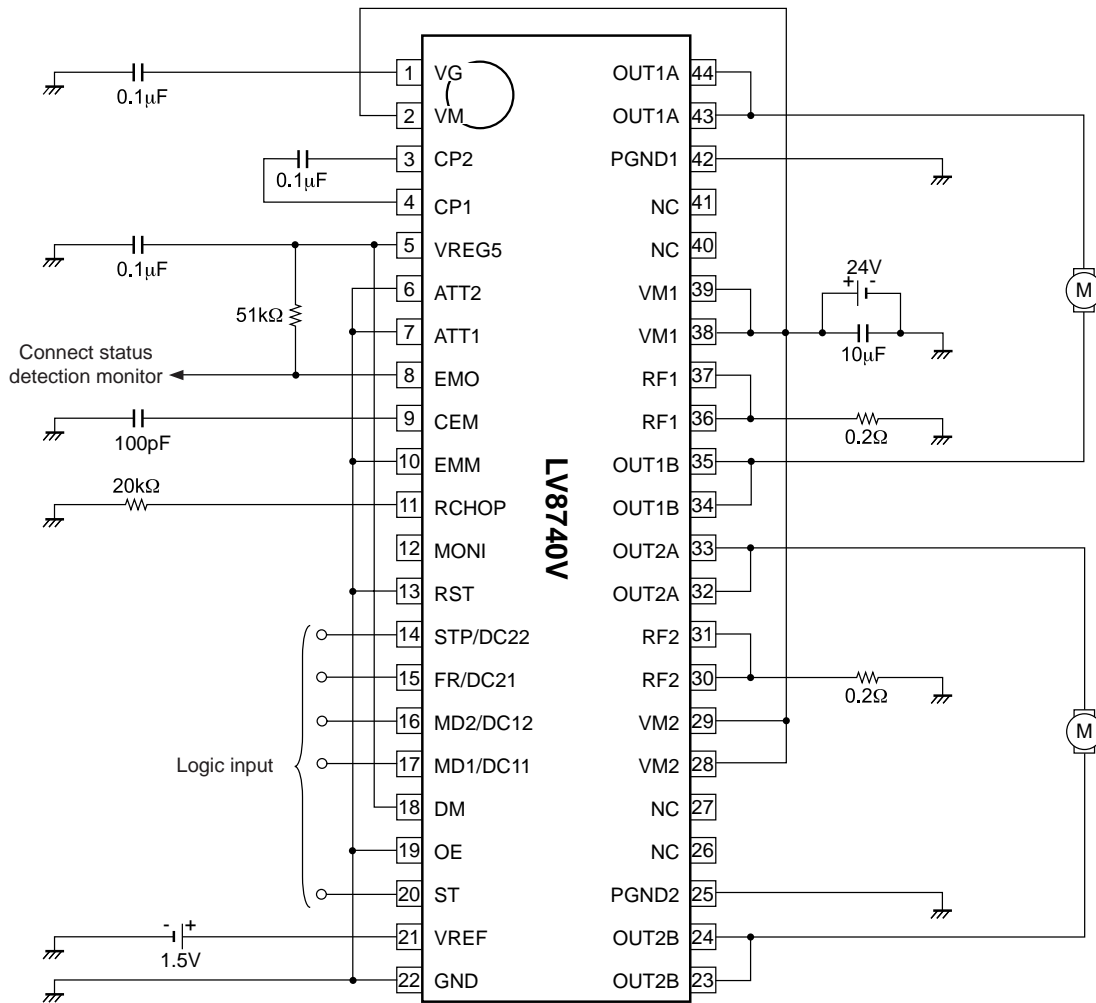

Each constant setting type in the example of the above-mentioned circuit is as follows.
When setting current LIMIT = 100%, VREF = 1.5V, the following output current flows :

$$\begin{aligned} I_{\text{limit}} &= V_{\text{REF}}/5/\text{RF resistance} \\ &= 1.5\text{V}/5 \times 100\%/0.2\Omega = 1.5\text{A} \end{aligned}$$

Chopping frequency setting.
62.5kHz (RCHOP=20kΩ)

Time of timer latch when output is short-circuited

$$\begin{aligned} T_{\text{cem}} &= C_{\text{cem}} * V_{\text{tcem}}/I_{\text{cem}} \\ &= 100\text{pF} * 1\text{V}/10\mu\text{A} = 10\mu\text{s} \end{aligned}$$

- SANYO Semiconductor Co.,Ltd. assumes no responsibility for equipment failures that result from using products at values that exceed, even momentarily, rated values (such as maximum ratings, operating condition ranges, or other parameters) listed in products specifications of any and all SANYO Semiconductor Co.,Ltd. products described or contained herein.
- SANYO Semiconductor Co.,Ltd. strives to supply high-quality high-reliability products, however, any and all semiconductor products fail or malfunction with some probability. It is possible that these probabilistic failures or malfunction could give rise to accidents or events that could endanger human lives, trouble that could give rise to smoke or fire, or accidents that could cause damage to other property. When designing equipment, adopt safety measures so that these kinds of accidents or events cannot occur. Such measures include but are not limited to protective circuits and error prevention circuits for safe design, redundant design, and structural design.
- In the event that any or all SANYO Semiconductor Co.,Ltd. products described or contained herein are controlled under any of applicable local export control laws and regulations, such products may require the export license from the authorities concerned in accordance with the above law.
- No part of this publication may be reproduced or transmitted in any form or by any means, electronic or mechanical, including photocopying and recording, or any information storage or retrieval system, or otherwise, without the prior written consent of SANYO Semiconductor Co.,Ltd.
- Any and all information described or contained herein are subject to change without notice due to product/technology improvement, etc. When designing equipment, refer to the "Delivery Specification" for the SANYO Semiconductor Co.,Ltd. product that you intend to use.
- Information (including circuit diagrams and circuit parameters) herein is for example only; it is not guaranteed for volume production.
- Upon using the technical information or products described herein, neither warranty nor license shall be granted with regard to intellectual property rights or any other rights of SANYO Semiconductor Co.,Ltd. or any third party. SANYO Semiconductor Co.,Ltd. shall not be liable for any claim or suits with regard to a third party's intellectual property rights which has resulted from the use of the technical information and products mentioned above.

This catalog provides information as of November, 2010. Specifications and information herein are subject to change without notice.