

MGA-14516

High Gain, High Linearity Active Bias Low Noise Amplifier



Data Sheet

Description

Avago Technologies' MGA-14516 is a two stage, easy-to-use GaAs MMIC Low Noise Amplifier (LNA) with active bias. The LNA has low noise with good input return loss and high linearity achieved through the use of Avago Technologies' proprietary 0.5um and 0.25um GaAs Enhancement-mode pHEMT process. Both LNAs have an extra feature inside that allows a designer to adjust supply current. The first stage has an additional feature where the gain can be adjusted externally without affecting noise figure. Minimum matching needed for input, output and the inter-stage between the two LNA.

It is designed for optimum use between 1.4GHz to 2.7GHz. For optimum performance at lower frequency from 400MHz to 1.5GHz, the MGA-13516 is recommended. Both MGA-13516 & MGA-14516 share the same package and pinout.

Pin Configuration and Package Marking

4.0 x 4.0 x 0.85 mm³ 16-lead QFN

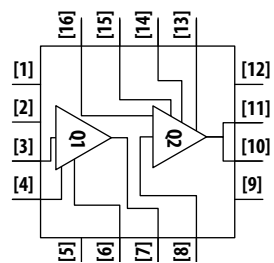
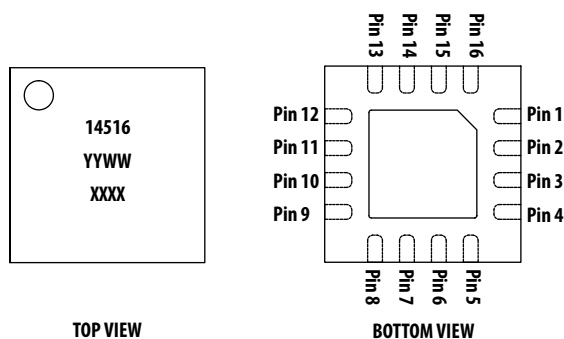

Pin	Description	Pin	Description
1	Not Used	9	Not Used
2	Gnd	10	RFout
3	RFin	11	RFout
4	RFgnd1	12	Not Used
5	Vbias1	13	Vg
6	FB1	14	RFgnd2
7	RFout1	15	Vm
8	RFin2	16	Vbias

Notes:

Package marking provides orientation and identification "14516" is the Product Identification, "YYWW" is the Date Code, "XXXX" is the last 4 digits of the lot number.

Features

- Low noise figure
- High gain
- Good IRL
- High linearity performance
- High reverse isolation
- Externally adjustable supply current
- Externally adjustable gain
- GaAs E-pHEMT Technology [1]
- Low cost QFN package
- Excellent uniformity in product specifications

Specifications

1.95GHz ; Q1 : 5V, 45mA (typ) Q2 : 5V, 110mA

- 31.7 dB Gain
- 0.68 dB Noise Figure
- 13 dB IRL
- 38 dBm Output IP3
- 23.5 dBm Output Power at 1dB gain compression

Applications

- Low noise amplifier for cellular infrastructure including GSM, CDMA, W-CDMA, TD-SCDMA and WiMAX.
- Other very low noise applications.

Note:

1. Enhancement mode technology employs positive Vgs, thereby eliminating the need of negative gate voltage associated with conventional depletion mode devices.



Attention: Observe precautions for handling electrostatic sensitive devices.
 ESD Machine Model = 40 V
 ESD Human Body Model = 200 V
 Refer to Avago Application Note A004R: *Electrostatic Discharge, Damage and Control.*

Absolute Maximum Rating [1]

Symbol	Parameter	Units	Absolute Max.
Vdd1	Device Supply Voltage	V	5.5
Vbias1	Control Voltage	V	3.5
Vdd2	Device Voltage, RF output to ground	V	6
Vbias	Control Voltage	V	6
Idd2	Device Drain Current	mA	150
P _{in,max}	CW RF Input Power (Vdd1 = 5.0V, Idd1=45mA)	dBm	20
P _{diss}	Total Power Dissipation [3]	W	1.30
T _j	Junction Temperature	°C	150
T _{STG}	Storage Temperature	°C	-65 to 150

Thermal Resistance [1-3] (V_{dd1}=V_{dd2}=V_{bias}=5V), $\theta_{jc} = 36 \text{ }^\circ\text{C/W}$

Notes:

1. Operation of this device in excess of any of these limits may cause permanent damage.
2. Thermal resistance measured using Infra-Red Microscopy Technique.
3. Board temperature T_B is 25 °C. Derate 28mW/°C for T_B>120 °C.

Product Consistency Distribution Charts [4]

T_A = 25 °C, 1.95GHz, Vdd1=5V, Vdd2=5V, Vbias=5V, F_{RF}=1.95GHz, unless stated otherwise.

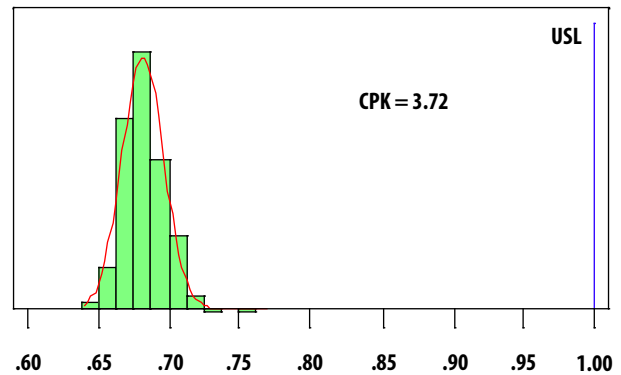
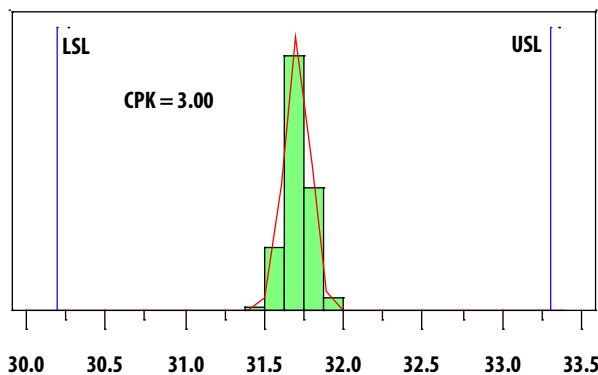
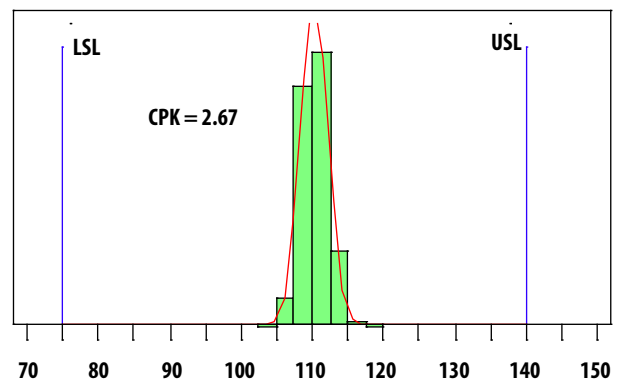
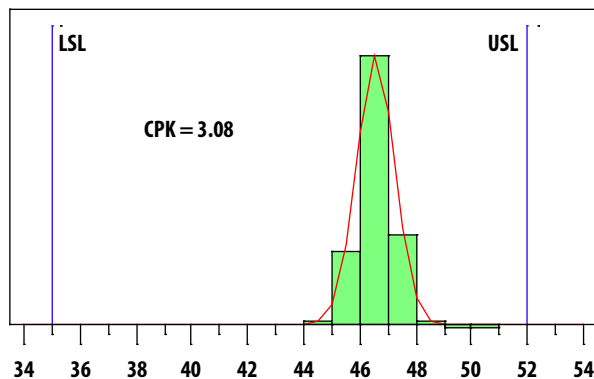

Notes:

4. Distribution data sample size is 500 samples taken from 3 different wafer lots. Future wafer allocated to this product may have nominal values anywhere between the upper and lower limits. Circuit losses have not been de-embedded from actual measurements.

Demo Board Layout

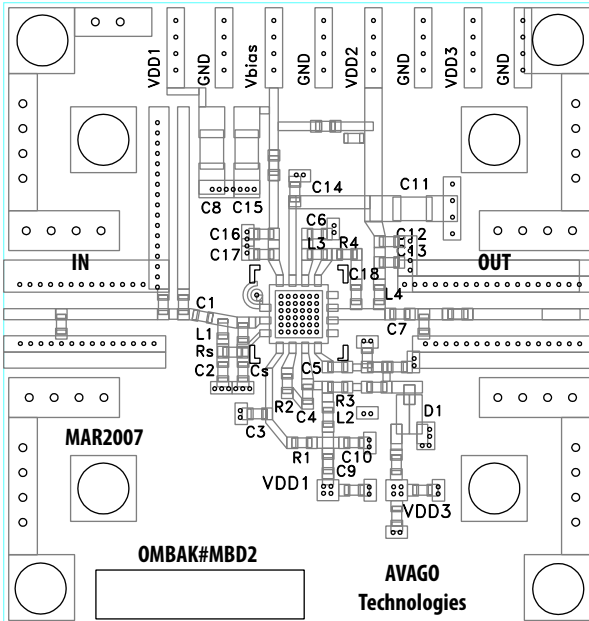

Notes:

- Recommended PCB material is 10 mils Rogers RO4350.
- Suggested component values may vary according to layout and PCB material.
- L1 and C1 form the input matching network.
- L4 and C7 form the output matching network.
- L2, L3, C5 form the inter-stage matching network.
- R2 and C4 form the network for externally gain adjustment feature. (optional)
- R4 and C18 form the network for externally gain adjustment feature. (optional)
- Cs, C6, C13 are RF bypass capacitor.
- C16 mitigates the effect of external noise pickup on the Vbias line.
- R1 is bias resistor for Q1.

Figure 5. Demo Board Layout

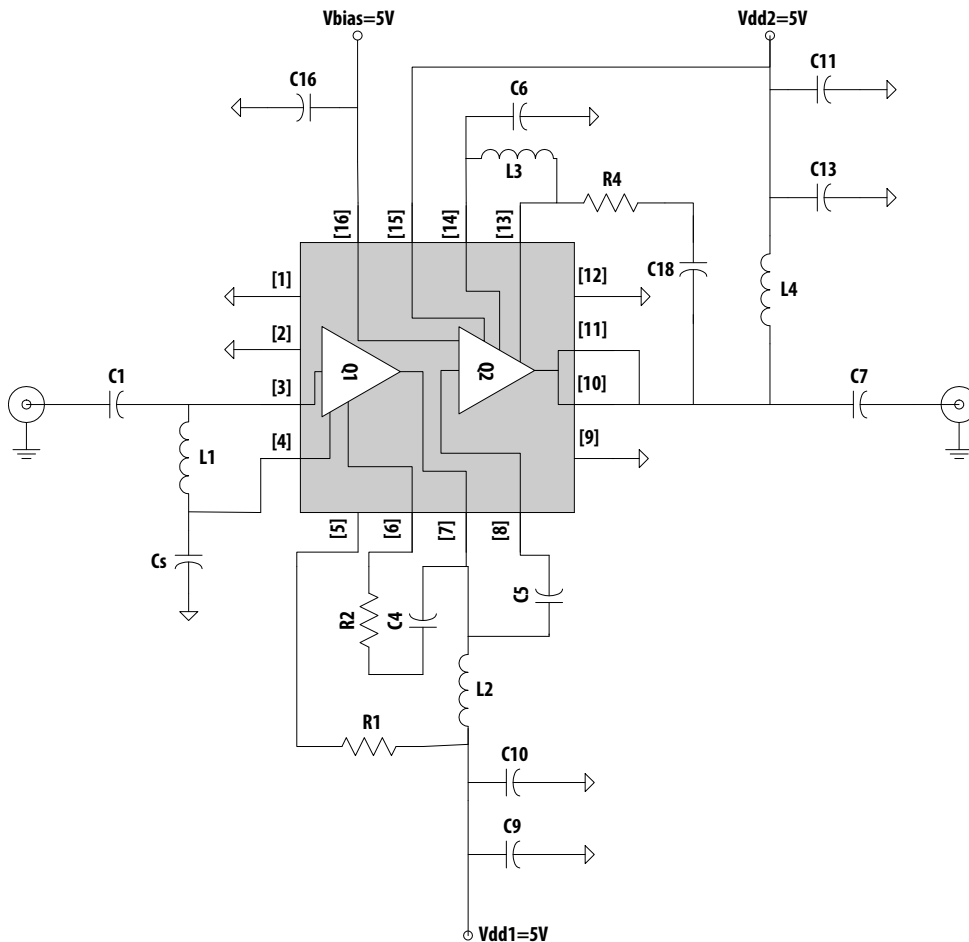

Figure 6. Demo Board Schematic

Table1. 1.95 GHz Matching Components

Demo board (shown in Figure 5) component values used for demo board schematic in Figure 6. These component values are used when measuring Electrical Specifications and plots of Figure 7 to Figure 17.

Part	Size	Value	Description
Cs	0402	100pF	Kyocera CM05CH101J50AHF
C1	0402	6.8pF	Rohm MCH155A068
C5	0402	7.5pF	Murata GRM615C0G7R5D50
C6	0402	10pF	Kyocera CM05CH100J50AHF
C7	0402	100pF	Kyocera CM05CH101J50AHF
C10	0402	100pF	Kyocera CM05CH101J50AHF
C13	0402	10pF	Kyocera CM05CH100J50AHF
C16	0402	10pF	Kyocera CM05CH100J50AHF
C18	0402	10pF	Kyocera CM05CH100J50AHF
L1	0402	5.6nH	Coilcraft 0402CS5N6XJBW
L2	0402	3.3nH	Toko LL1005-FHL3N3S
L3	0402	39nH	Toko LL1005-FHL39NJ
L4	0402	10nH	Toko LL1005-FHL10NJ
R1	0402	1.8kohm	Rohm MCR01MZSJ182
R4	0402	220ohm	Rohm MCR01MZSJ221

Electrical Specifications [1, 2]

$T_A = 25\text{ }^\circ\text{C}$, $V_{dd1}=5\text{V}$, $V_{dd2}=5\text{V}$, $V_{bias}=5\text{V}$, $F_{RF}=1.95\text{GHz}$, unless stated otherwise.

Symbol	Parameter and Test Condition	Units	Min.	Typ.	Max.
I _{dd1}	Current at Q1	mA	35	45	52
I _{dd2}	Current at Q2	mA	75	110	140
I _{bias}	Bias Current for Q2	mA		5	
Gain	Associated Gain	dB	30.2	31.7	33.3
NF	Noise Figure in 50Ω system	dB		0.68	1.0
OIP3	Output Third Order Intercept Point (2-tone @ $F_{RF} \pm 1\text{MHz}$, $P_{in} = -25\text{dBm}$)	dBm		38	
OP1dB	Output Power at 1dB Gain Compression	dBm		23.5	
IRL	Input Return Loss	dB		13	
ORL	Output Return Loss	dB		15	
S12	Reverse Isolation	dB		-50	

Notes:

1. Measurements obtained using demo board described in Figure 5 with component list in Table 1. Input and Output trace loss is not de-embedded from the measurement.
2. Guaranteed specifications are 100% tested in production test circuit.

MGA-14516 Typical Performance

$T_A = 25^\circ\text{C}$, $V_{dd1}=5\text{V}$, $V_{dd2}=5\text{V}$, $V_{bias}=5\text{V}$ unless stated otherwise. Measured on demo board in Figure 5 with components listed in Table 1.

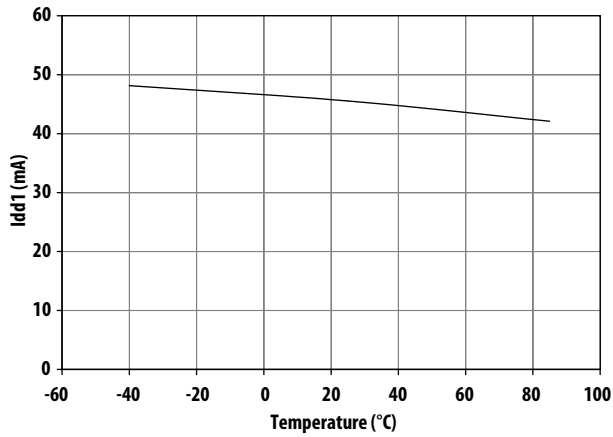

Figure 7. Idd1 vs. Temperature

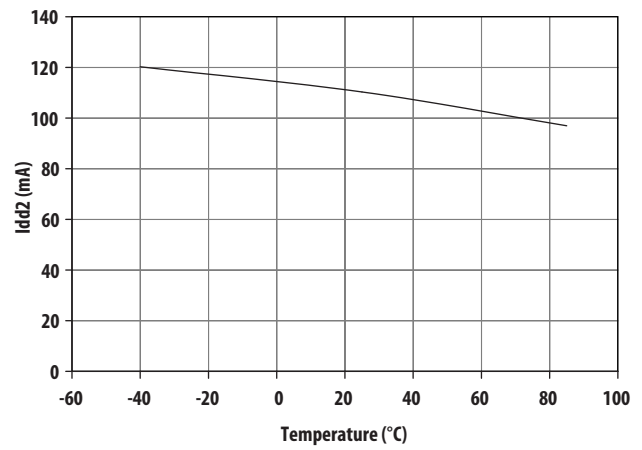

Figure 8. Idd2 vs. Temperature

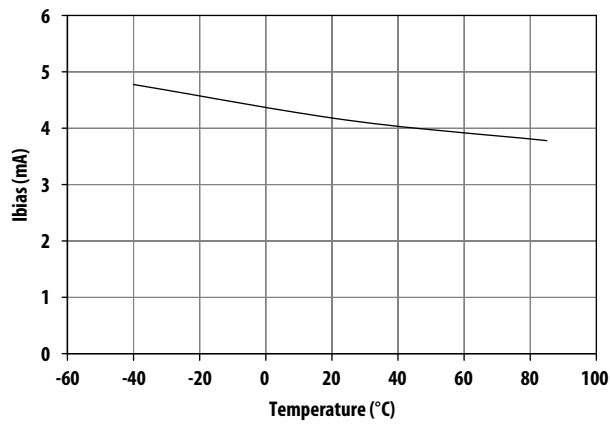

Figure 9. Ibias vs. Temperature

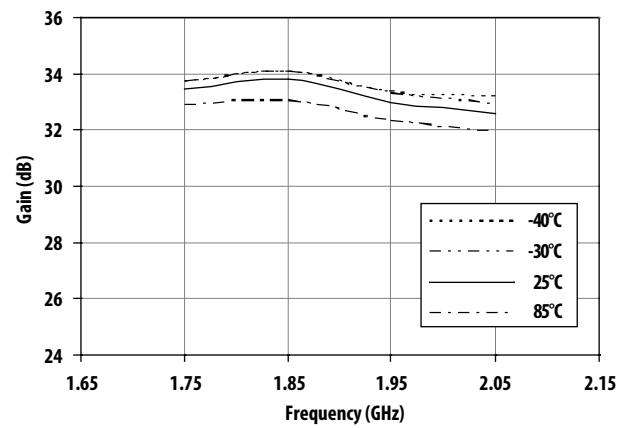

Figure 10. Gain vs. Frequency and Temperature

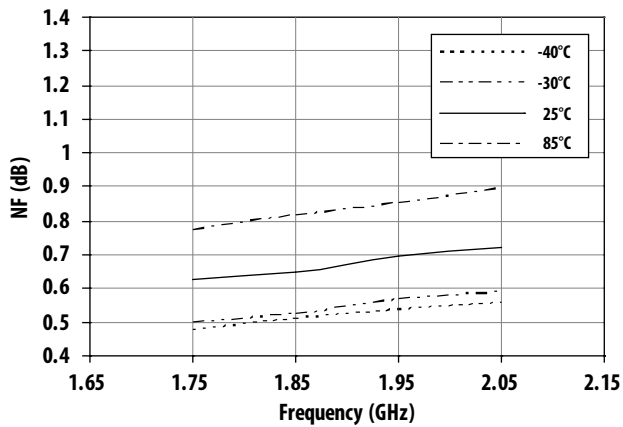

Figure 11. NF vs. Frequency and Temperature

MGA-14516 Typical Performance

$T_A = 25^\circ\text{C}$, $V_{dd1}=5\text{V}$, $V_{dd2}=5\text{V}$, $V_{bias}=5\text{V}$ unless stated otherwise. Measured on demo board in Figure 5 with components listed in Table 1.

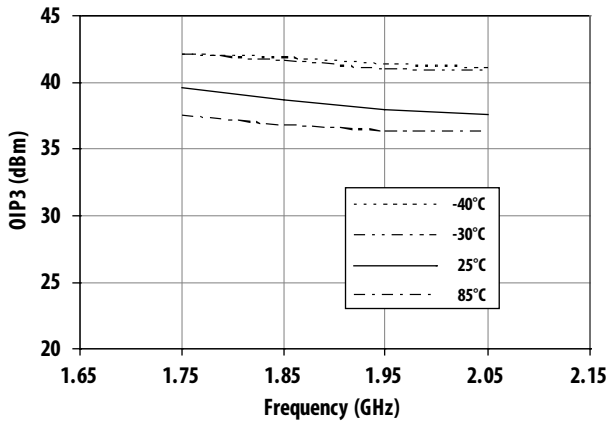

Figure 12. OIP3 vs. Frequency and Temperature

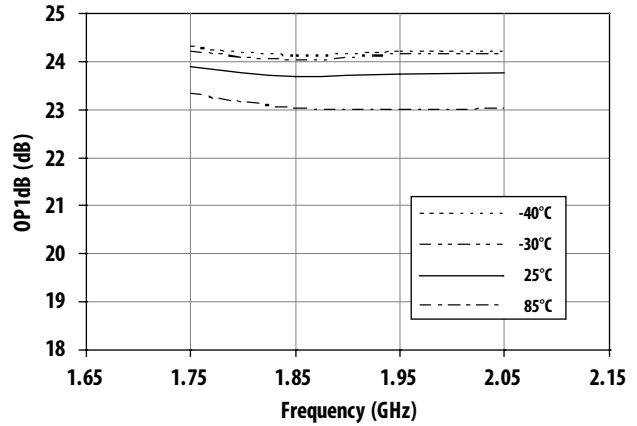

Figure 13. OP1dB vs. Frequency and Temperature

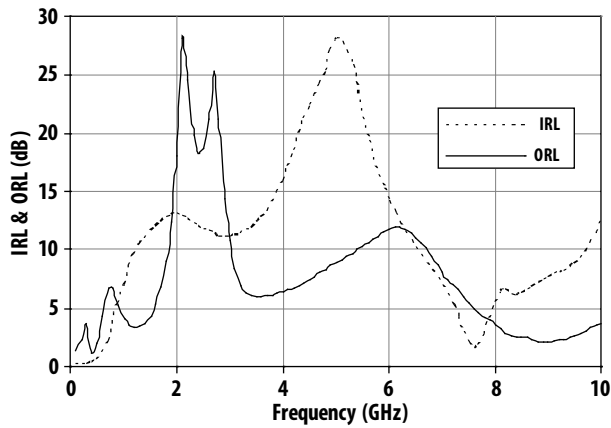

Figure 14. IRL & ORL vs. Frequency

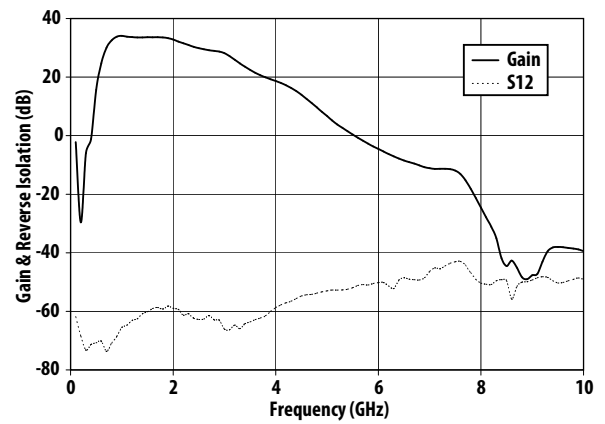

Figure 15. Gain & S12 vs. Frequency

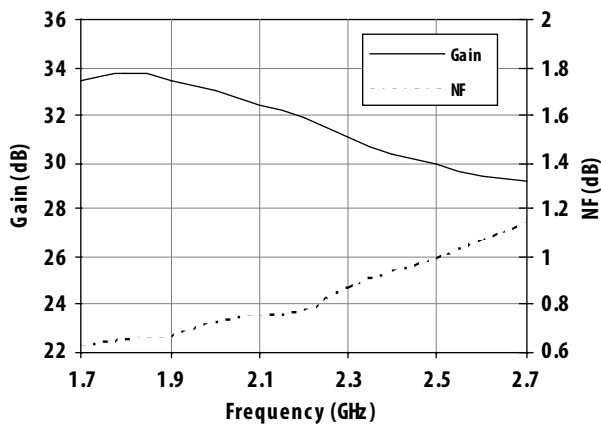

Figure 16. Gain and NF vs. Frequency

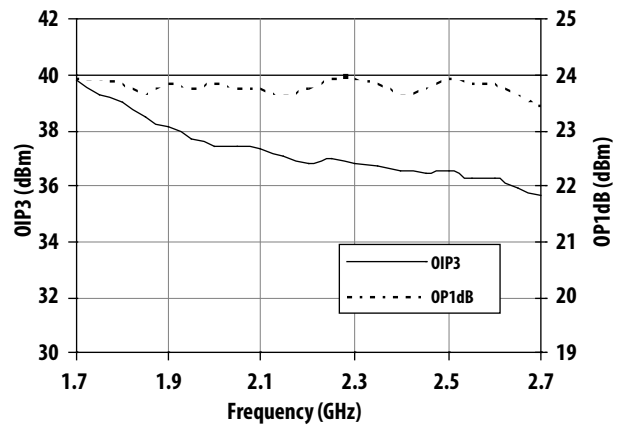

Figure 17. OIP3 and OP1dB vs. Frequency

MGA-14516 Scattering Parameter and Noise Parameter Test Setup

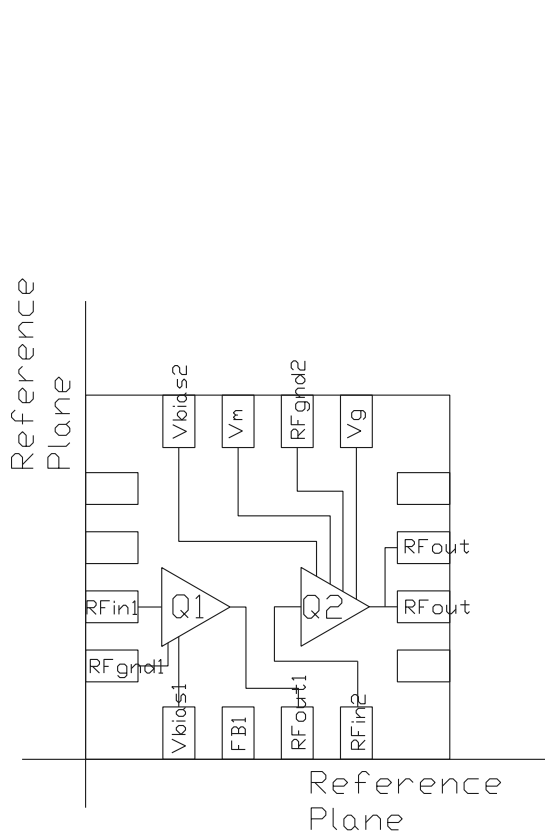

Figure 18. Test setup for Q1 S & Noise Parameters data.

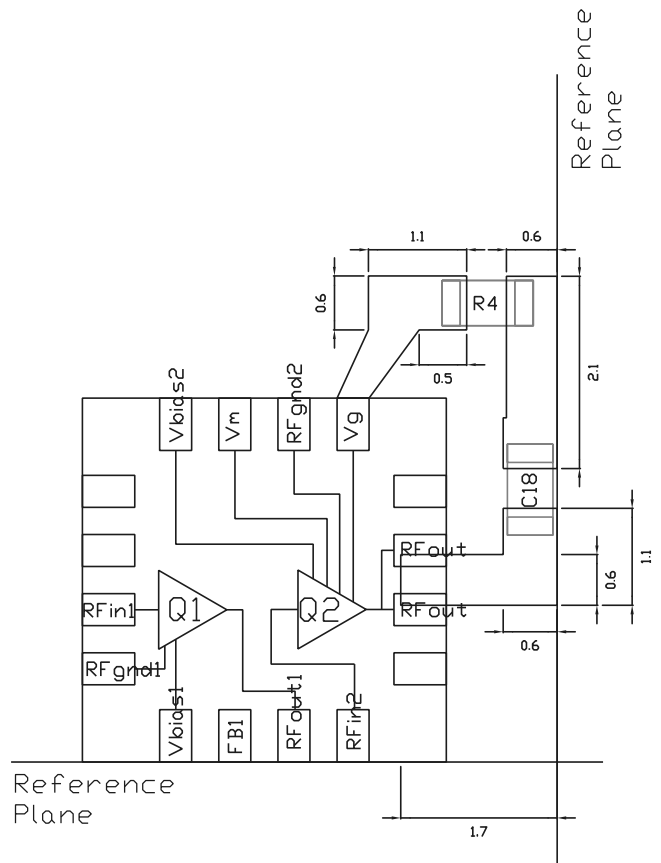

Figure 19. Test setup for Q2 S & Noise Parameters data. C18=10pF (Kyocera CM05CH100J50AHF) and R4=220Ω (Rohm MCR01MZSJ221).

MGA-14516 Q1 Typical Scattering Parameters, Vdd1=5V, Idd1=45mA

Freq (GHz)	S11		S21		S12		S22	
	Mag	Ang	Mag	Ang	Mag	Ang	Mag	Ang
0.1	0.96	-9.2	25.54	142.9	0.003	31.5	0.68	-5.5
0.5	0.76	-37.2	18.78	129.4	0.003	39.6	0.62	-14.9
0.9	0.58	-51.9	13.36	106.3	0.004	53	0.61	-24
1	0.55	-54.3	12.33	101.8	0.005	54.5	0.61	-26.4
1.5	0.44	-60.9	8.65	84.7	0.006	62.1	0.61	-36.3
1.9	0.39	-62.5	6.85	74.6	0.006	63.4	0.62	-41.5
2	0.39	-62.4	6.51	72.7	0.007	65.5	0.62	-42.3
2.5	0.37	-60.6	5.26	63.7	0.008	67.4	0.62	-44.8
3	0.34	-56	4.55	55.7	0.008	73.2	0.58	-46.6
3.5	0.32	-50.2	4.16	46.7	0.009	76.9	0.51	-52.7
4	0.27	-45.4	3.89	35.3	0.01	82.2	0.42	-71.3
5	0.15	-48.6	3.15	9.3	0.011	95.6	0.48	-126.8
6	0.15	-128.6	2.46	-10.9	0.016	116.3	0.64	-135.7
7	0.41	-139.6	2.19	-30.6	0.03	126.4	0.6	-138.9
8	0.6	-130	1.8	-69	0.075	111.2	0.48	150.5
9	0.46	-104.8	0.88	-72.6	0.055	33.9	0.63	95.3
10	0.29	-66.6	1.14	-89.3	0.033	81.9	0.81	132

Note: S-parameters are measured on PCB. The PCB material is 10 mils Rogers RO4350. Figure 18 shows the input and output reference planes.

MGA-14516 Q1 Typical Noise Parameter, Vdd1=5V, Idd1=45mA

Freq (GHz)	Fmin(dB)	Γ_{opt}		Rn/50
		mag	ang.	
1.5	0.38	0.38	90.52	0.04
1.7	0.45	0.37	107.31	0.04
1.9	0.53	0.33	122.23	0.04
2.4	0.57	0.38	136.86	0.04

Note: Noise parameters are measured on PCB. The PCB material is 10 mils Rogers RO4350. Figure 18 shows the input and output reference planes.

MGA-14516 Q2 Typical Scattering Parameters, Vdd2=5V, Vbias=5V, IDD2=110mA

Freq (GHz)	S11		S21		S12		S22	
	Mag	Ang	Mag	Ang	Mag	Ang	Mag	Ang
0.1	0.19	-147.9	6.24	147.2	0.051	4.1	0.65	-170.6
0.5	0.17	149.6	5.14	147	0.051	-2.2	0.61	175
0.9	0.17	122	5.11	128.8	0.056	-7	0.53	167.6
1	0.17	115.6	5.12	123.9	0.058	-9	0.51	165.5
1.5	0.12	76.4	5.24	97.1	0.066	-23.2	0.34	153.3
1.9	0.09	-9.4	5.33	72.6	0.071	-41.5	0.16	146.6
2	0.1	-34.3	5.33	66.1	0.071	-47	0.12	148.7
2.5	0.25	-95.1	5.23	32.1	0.066	-80.1	0.09	-125.5
3	0.34	-115	5.18	-8.3	0.05	-120.9	0.04	-125.3
3.5	0.52	-126.2	3.76	-64.8	0.025	-154.7	0.26	-54.9
4	0.63	-154.7	1.72	-99.5	0.019	-165.4	0.4	-99.7
5	0.69	164.3	0.59	-129.9	0.019	141	0.37	-119.7
6	0.7	133.3	0.28	-155.1	0.023	105.2	0.32	-107.4
7	0.65	74.5	0.15	165	0.025	66.5	0.33	-76.1
8	0.83	-1.1	0.04	124	0.008	35.3	0.48	-53.6
9	0.71	-1.2	0.01	114.2	0.006	47.1	0.47	-27
10	0.52	34.1	0.01	159.2	0.008	153.6	0.58	-8.3

Note: S-parameters are measured on PCB. The PCB material is 10 mils Rogers RO4350. Figure 19 shows the input and output reference planes.

MGA-14516 Q2 Typical Noise Parameter, Vdd2=5V, Idd2=110mA

Freq (GHz)	Fmin(dB)	Γopt		Rn/50
		mag	ang.	
1.5	3.11	0.12	15.54	0.36
1.7	3.13	0.12	36.67	0.44
1.9	3.27	0.12	57.69	0.52
2.4	3.68	0.24	93.03	0.57

Note: Noise parameters are measured on PCB. The PCB material is 10 mils Rogers RO4350. Figure 19 shows the input and output reference planes.

Part Number Ordering Information

Part Number	No. of Devices	Container
MGA-14516-TR1G	1000	7" Reel
MGA-14516-TR2G	3000	13" Reel
MGA-14516-BLKG	100	antistatic bag

SLP4X4 Package Dimension

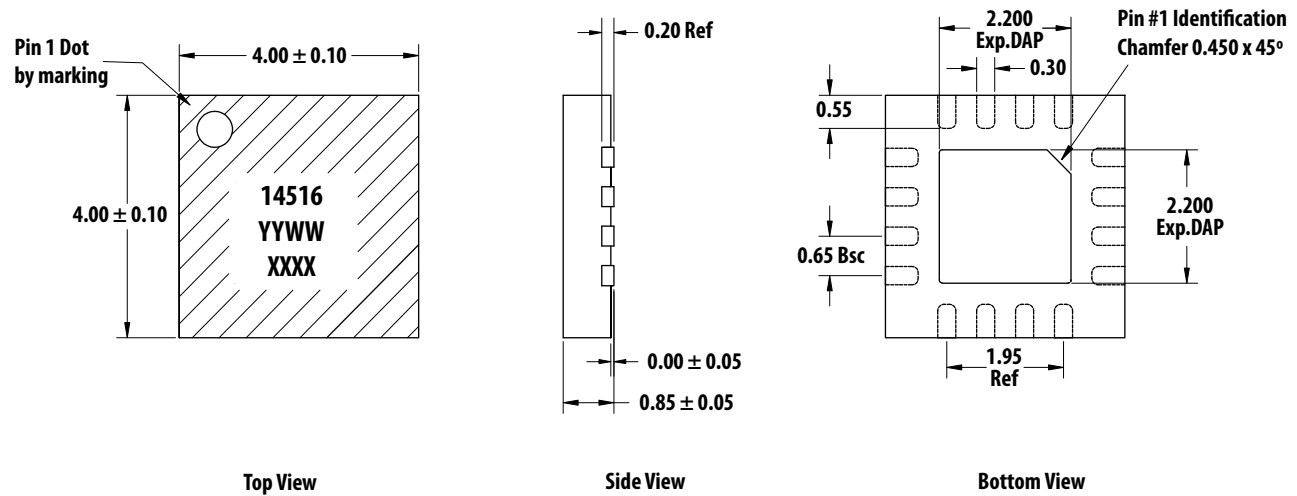

Notes:

1. All dimensions are in millimeters.
2. Dimensions are inclusive of plating.
3. Dimensions are exclusive of mold ash and metal burr.

PCB Land Pattern and Stencil Design

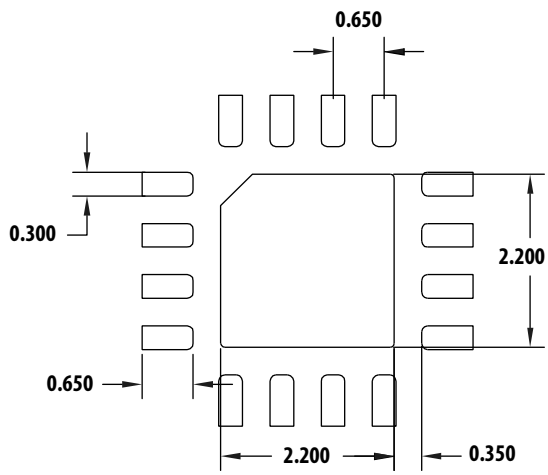

PCB Land Pattern (Top View)

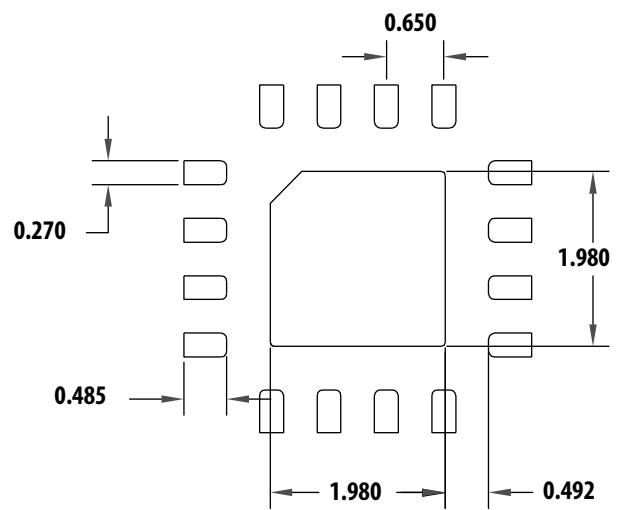

Stencil Outline

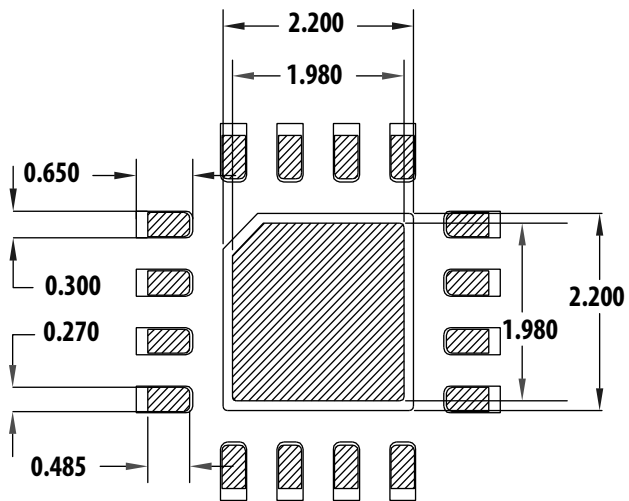

Combines PCB & Stencil Layouts
All Dimension are in MM

Device Orientation

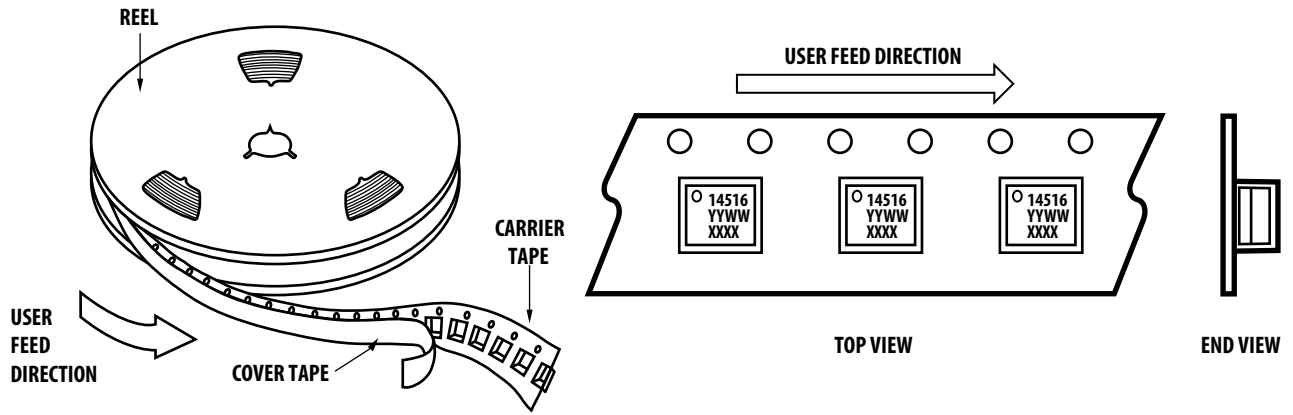

Tape Dimensions

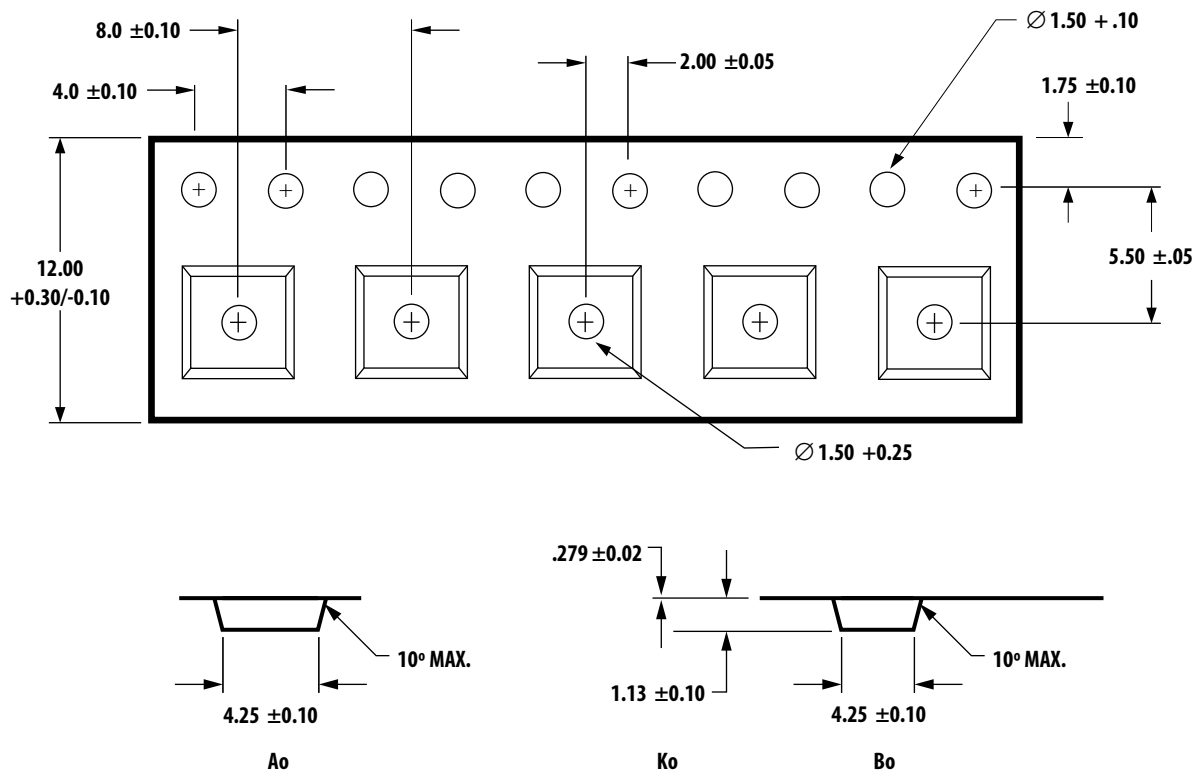

Reel Dimension - 7 Inch

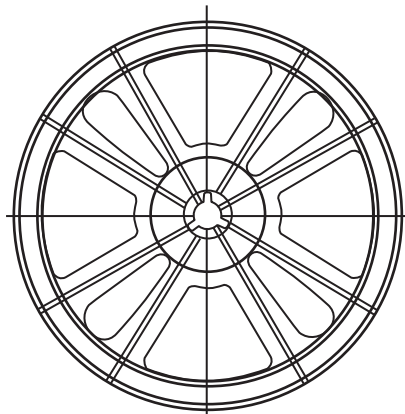

FRONT VIEW

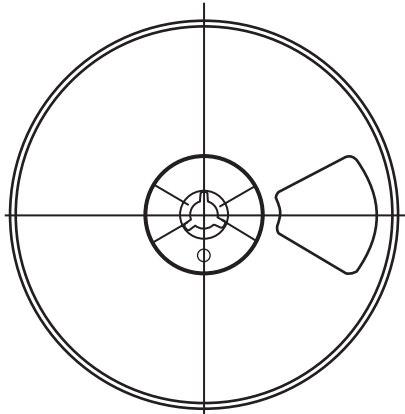

BACK VIEW

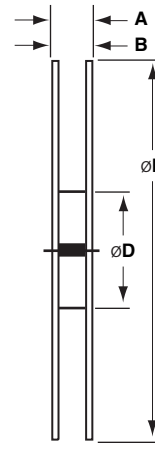

SIDE VIEW

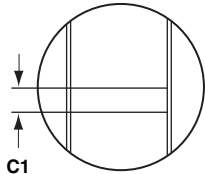

C1

TAPE SLOT
PLANE VIEW

SPECIFICATION								
TAPE WIDTH	A MAX	B +1.5-0.0	C1 ±0.5	ØD ±0.5	ØE (max)	F (min)	ØG ±0.2	ØH (min)
12mm	18.00	12.4	4.40	55.0	178	1.50	13.50	20.20

Note: Surface resistivity to be $<10^{12}$ Ohms/square

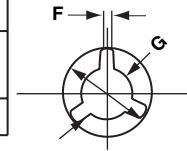

ARBOR HOLE

Reel Dimension - 13 Inch

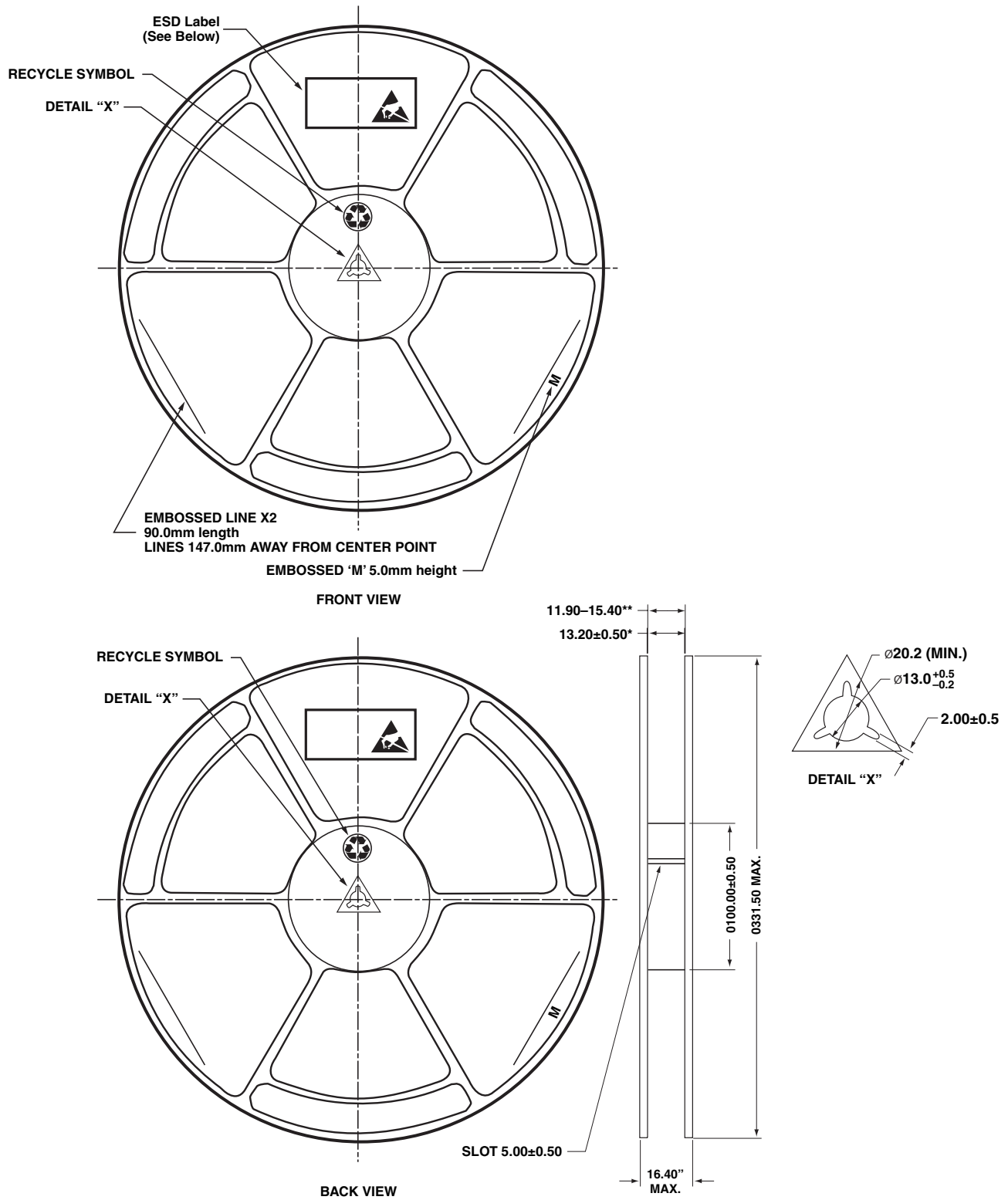

For product information and a complete list of distributors, please go to our web site: www.avagotech.com

Avago, Avago Technologies, and the A logo are trademarks of Avago Technologies in the United States and other countries. Data subject to change. Copyright © 2005-2008 Avago Technologies. All rights reserved. AV02-1049EN - July 3, 2008

