

## Data Sheet

### Description/Applications

The MGA-785T6 is an easy-to-use GaAs MMIC Low Noise Amplifier (LNA) that offer excellent linearity and low noise figure for application from 0.1 to 1.5 GHz. The device is housed in Ultra Thin Small Leadless Package (UTSLP) with 0.4mm package thickness.

The MGA-785T6 features a typical noise figure of 1.5 dB and 15.7 dB associated gain from single stage, feedback FET amplifier. The output is internally matched to 50Ω. The input is optimally internally matched for lowest noise figure into 50Ω. The input may be additionally externally matched for low VSWR through the addition of a single series inductor. When set into the bypass mode, both input and output are internally matched to 50 Ω.

The MGA-785T6 offers an integrated solution of LNA with adjustable IIP3. The IIP3 can be fixed to a desired current level for the receiver's linearity requirements. The LNA has a bypass switch function, which sets the current to zero and provides low insertion loss. The bypass mode also boosts dynamic range when high level signal is being received.

### Package Marking & Orientation

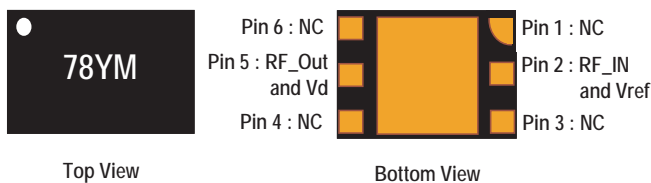

78 = Device Code  
Y = Year of manufacture  
M = Month of manufacture

### Features

- Operating Freq = 0.1 ~1.5 GHz
- Bypass Switch on Chip
- Adjustable Input IP3
- Miniature Surface Mount 2.0x1.3x0.4 mm<sup>3</sup> 6-lead UTSLP

### Specifications at 600 MHz; 3V 10 mA (Typ.)

- 1.5 dB Noise Figure
- 15.7 dB Gain
- Bypass Switch on chip  
Loss = -2.6 dB  
IIP3 = + 29.5 dBm

### Applications

LNA for DVB-T, DVB-H, T-DMB, ISDB-T, DAB and MediaFLO

**Table 1. Absolute Maximum Rating [1]**

Symbol	Parameter	Units	Absolute Max.	Max. Recommended
Vd	Device Voltage	V	5.5	4.2
Vref	Max Input to Ground DC Voltage	V	+0.3 -5.5	+0.1 -4.2
Ids	Drain Current	mA	70	60
P <sub>d</sub>	Power Dissipation	mW	300	250
P <sub>in,max</sub>	CW RF Input Power	dBm	+20	+13
T <sub>j</sub>	Junction Temperature	°C	170	150
T <sub>STG</sub>	Storage Temperature	°C	-65 to +150	-40 to +85

Thermal Resistance [2] :  $\theta_{jc} = 82 \text{ }^\circ\text{C} / \text{W}$

Notes:

1. Operation of this device in excess of any of these limits may cause permanent damage.
2. Thermal Resistance is measured from junction to board using IR method.

**Table 2. Electrical Specifications**

T<sub>A</sub> = 25 °C , Freq = 0.6 GHz, Vd = 3V (unless otherwise specified)

Symbol	Parameter and Test Condition			Units	Min.	Typ	Max.
Vref [1,2]	Input to Ground DC Voltage	Vd = 3V	Id = 10 mA	V	-0.80	-0.61	-0.42
NF [1,2]	Noise Figure in test circuit	Vd = 3V	Id = 10 mA	dB	-	1.50	1.90
Gain [1,2]	Associated Gain in test circuit	Vd = 3V	Id = 10 mA	dB	14.00	15.40	17.00
IIP3 [1,2,3]	Input 3rd Order Intercept in test circuit	Vd = 3V	Id = 10 mA	dBm	-0.50	1.10	-
P1dB [1,2]	Output Power at 1 dB Gain Compression in test circuit	Vd = 3V	Id = 10 mA	dBm	-	3.20	-
Ig (Bypass) [1,2]	Gate Leakage Current (Bypass mode)	Vd = 0, Vref = -3V	Id = 0 mA	uA	-	1.70	-
IIP3 (Bypass) [1,2,4]	Input 3rd Order Intercept in test circuit (bypass mode)	Vd = 0, Vref = -3V	Id = 0 mA	dBm	26.50	29.50	-
IL (Bypass) [1,2]	Insertion Loss in test circuit (bypass mode)	Vd = 0, Vref = -3V	Id = 0 mA	dB	-4.00	-2.60	-

Notes:

1. Circuit losses have been de-embedded from actual measurement.
2. Measurement in table 2 uses the test board and circuit schematic shows in figure 1a. Data based on 500 part sample size from two wafer lots during initial characterization of this product.
3. 0.6 GHz IIP3 Test Condition : F1 = 0.6 GHz, F2 = 0.605 GHz, Pin = -25 dBm
4. 0.6 GHz IIP3 (Bypass) Test Condition : F1 = 0.6 GHz, F2 = 0.605 GHz, Pin = -15 dBm

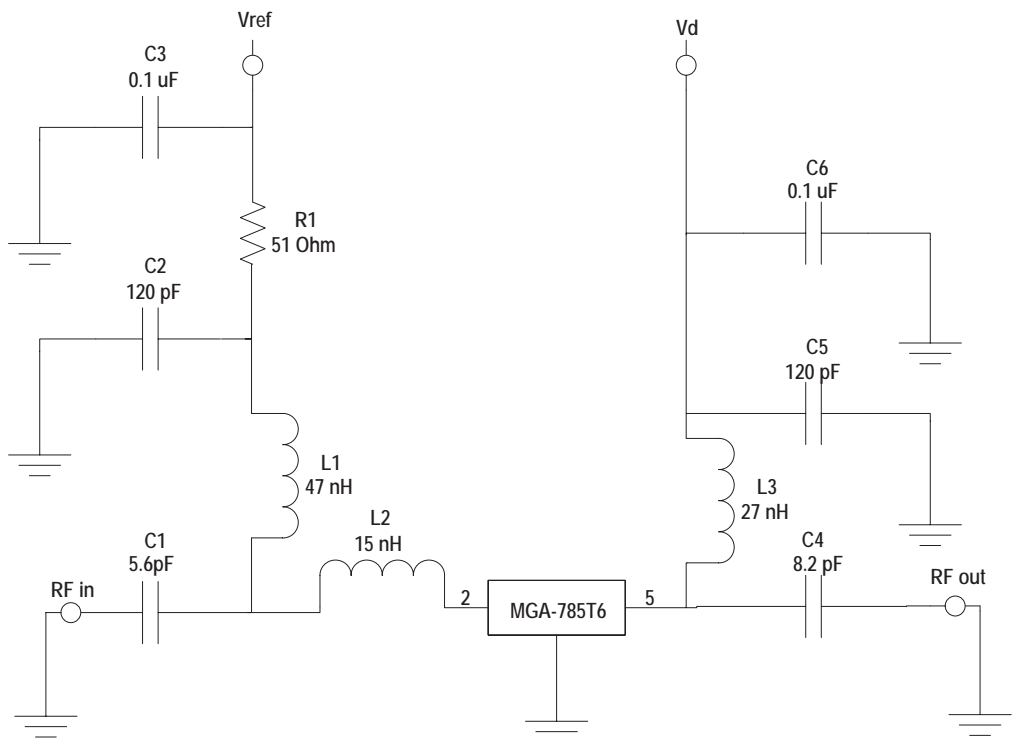

Circuit Symbol	Size	Description
C1	0402	5.6 pF
C2, C5	0402	120 pF
C3, C6	0402	0.1 uF
C4	0402	8.2 pF
R1	0402	51 ohm
L1	0402	47 nH
L2	0402	15 nH
L3	0402	27 nH

Figure 1a. MGA-785T6 Production Test Circuit. Circuit losses have been de-embedded from actual measurements.

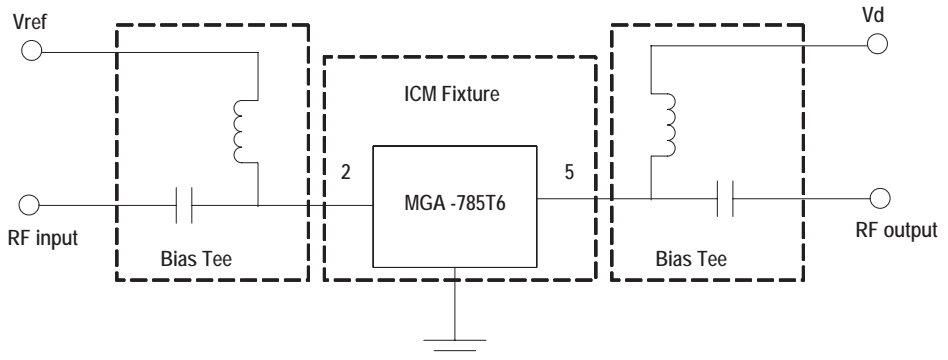
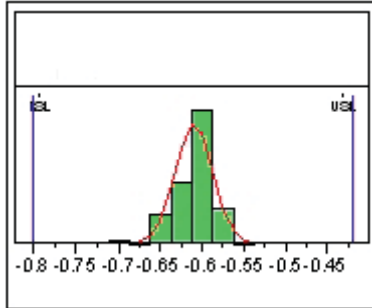
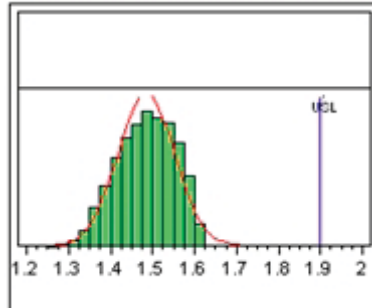

Figure 1b. A diagram showing the connection to the DUT during an S-parameter and Noise parameter measurement using an Automated Tuner System

## Product Consistency Distribution Charts at 0.6 GHz, $V_d = 3\text{ V}$ , $I_d = 10\text{ mA}$



**Figure 2.**  $V_{ref}$  @ 3V 10mA, LSL=-0.75, Nominal=-0.61, USL=-0.47



**Figure 3.** NF @ 0.6GHz 3V 10mA, Nominal=1.5, USL=1.8

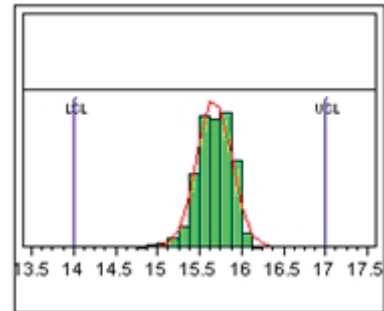

**Figure 4.** Gain @ 0.6GHz 3V 10mA, LSL=14.25, Nominal=15.70, USL=17.25

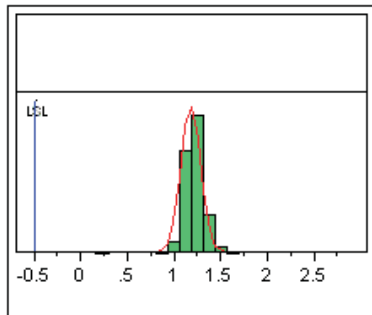

**Figure 5.** IIP3 @ 0.6GHz 3V 10mA, LSL=-0.5, Nominal=1.1

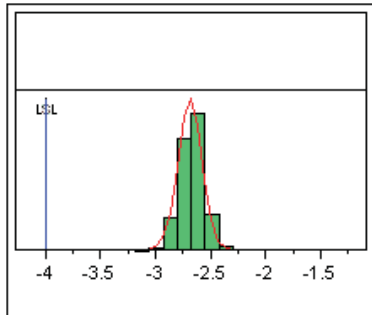

**Figure 6.**  $I_{L\_bypass}$  @ 0.6GHz 3V 0mA, LSL=-4.0, Nominal=-2.6

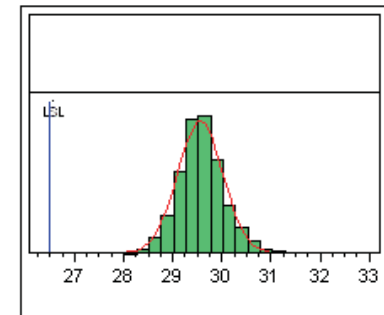

**Figure 7.** IIP3\_bypass @ 0.6GHz 3V 0mA, LSL=26.5, Nominal=29.5

Note:

1. Measurement uses the test board and circuit schematics shows in Figure 1a.
2. Distribution data based on 500 part sample size from two wafer lots during initial characterization of this product. Future wafers allocated to this product may have nominal values anywhere between upper and lower limits.

## MGA-785T6 Typical Performance,

$T_A = 25\text{ }^\circ\text{C}$ ,  $V_d = 3\text{V}$ ,  $I_d = 10\text{mA}$  (unless otherwise specified). All data as measured in Figure 1a test circuit.

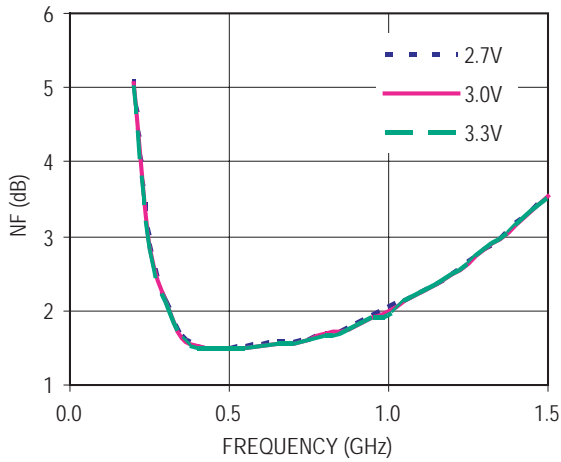

Figure 8. Noise Figure vs Frequency and Voltage (Vd)

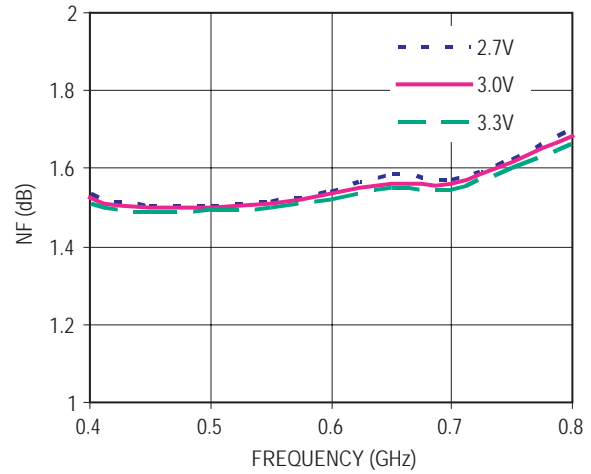

Figure 9. Noise Figure vs Frequency (0.4 – 0.8GHz) and Voltage (Vd)

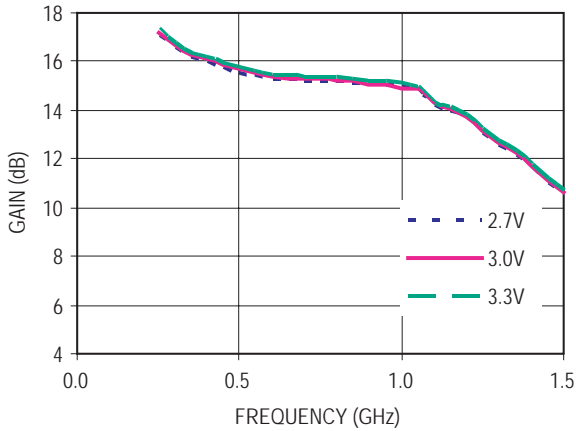

Figure 10. Gain vs Frequency and Voltage (Vd)

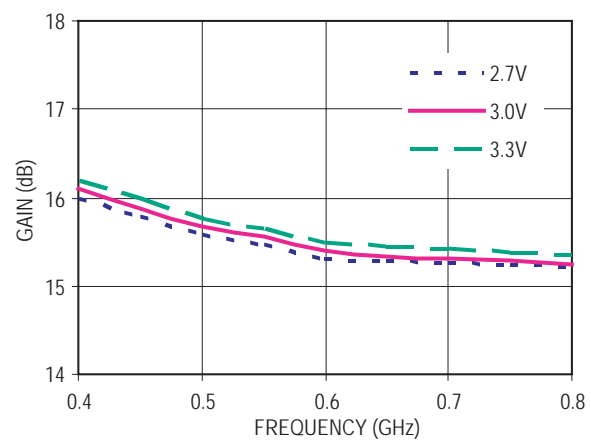

Figure 11. Gain vs Frequency (0.4 – 0.8GHz) and Voltage (Vd)

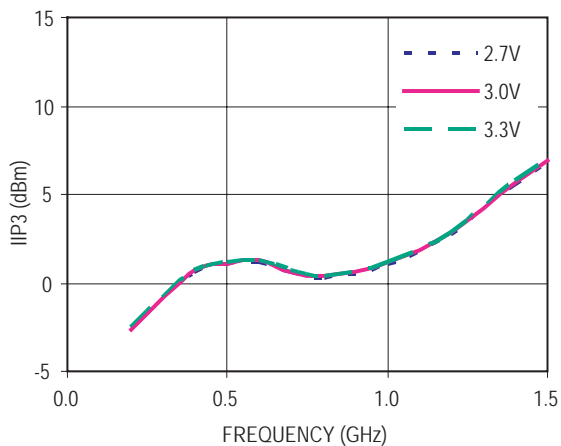

Figure 12. Input Third Order Intercept Point vs Frequency and Voltage (Vd)

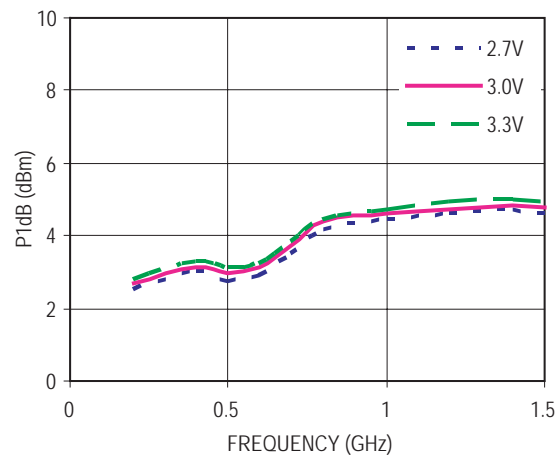

Figure 13. Output Power at 1dB Compression vs Frequency and Voltage (Vd)

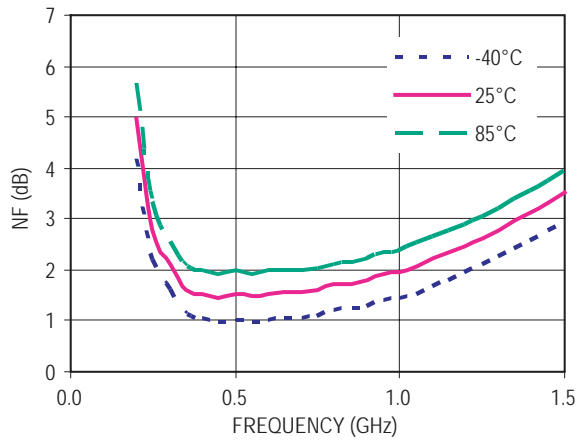

Figure 14. Noise Figure vs Frequency and Temperature

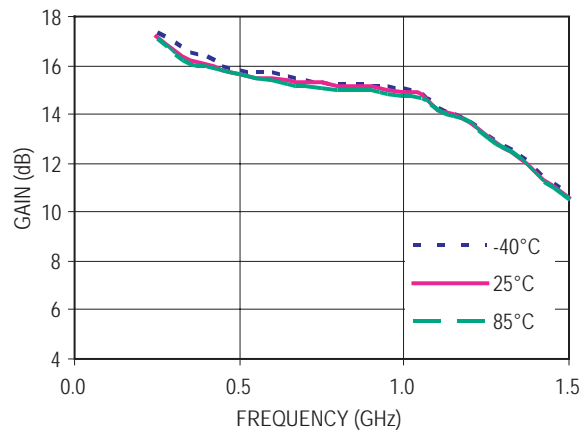

Figure 15. Gain vs Frequency and Temperature

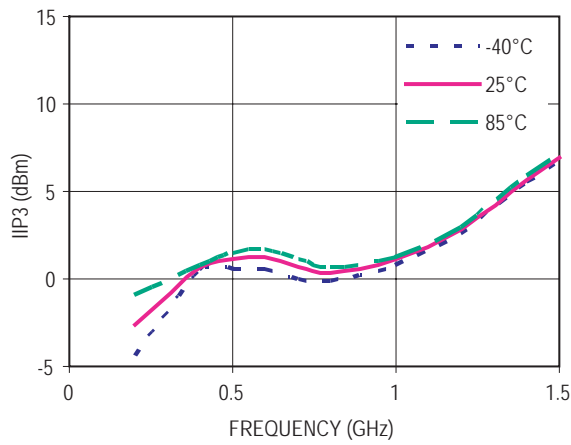

Figure 16. Input Third Order Intercept Point vs Frequency and Temperature

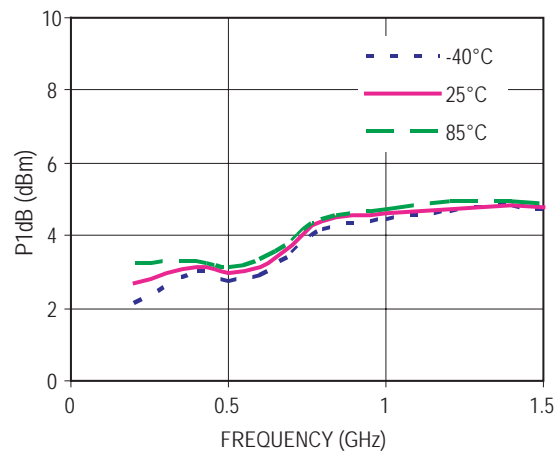

Figure 17. Output Power at 1dB Compression vs Frequency and Temperature

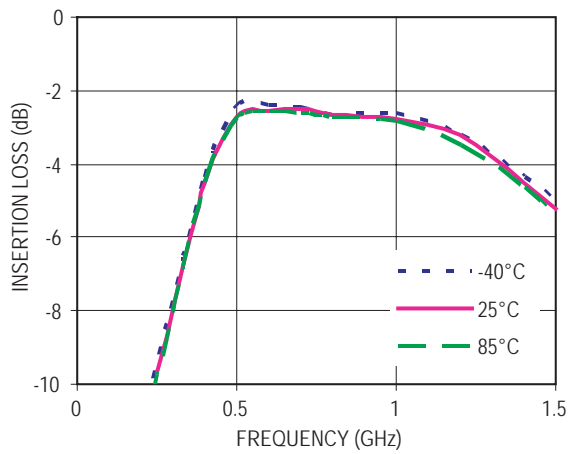

Figure 18. Insertion Loss (Switch on) vs Frequency and Temperature.

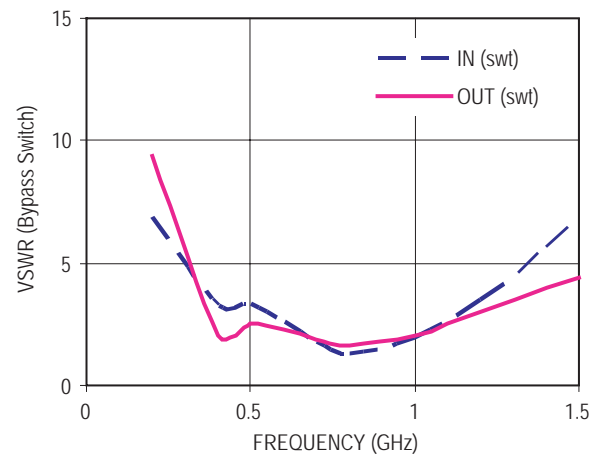

Figure 19. LNA off (Switch on) VSWR vs Frequency

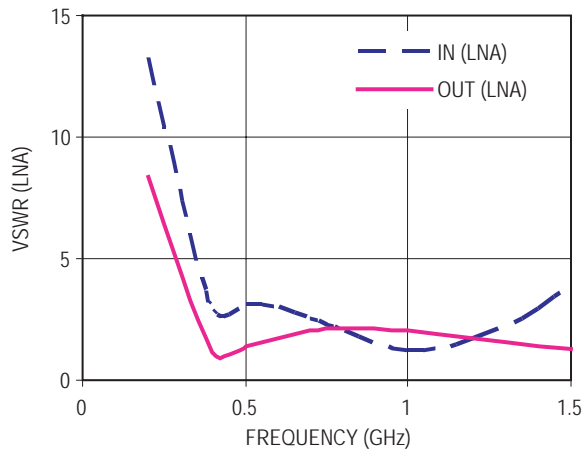

Figure 20. LNA on (Switch off) VSWR vs Frequency

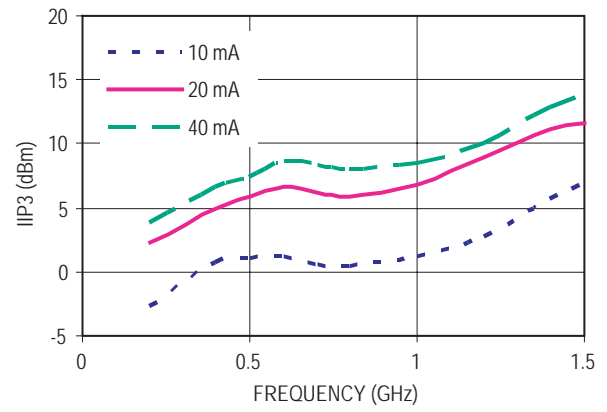

Figure 21. Input Third Order Intercept Point vs Frequency and Current

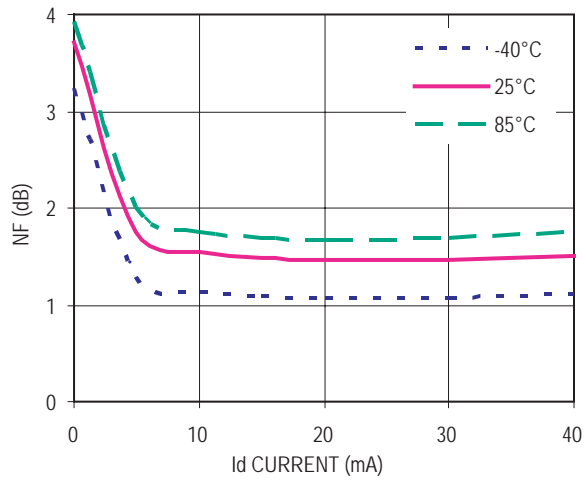

Figure 22. Noise Figure vs Current and Temperature (Freq = 600 MHz)

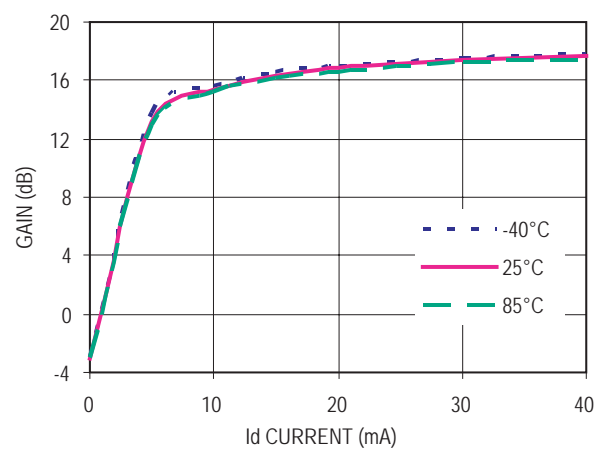
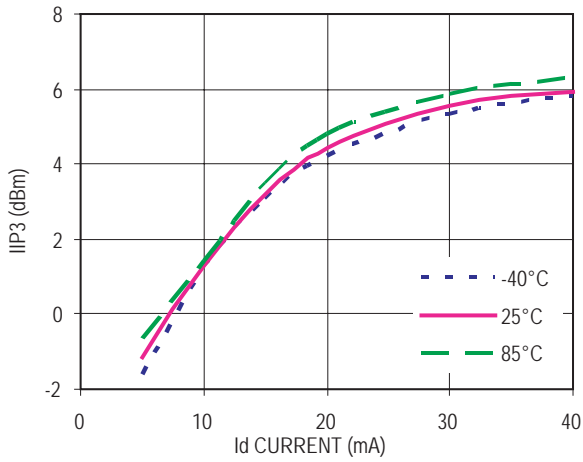
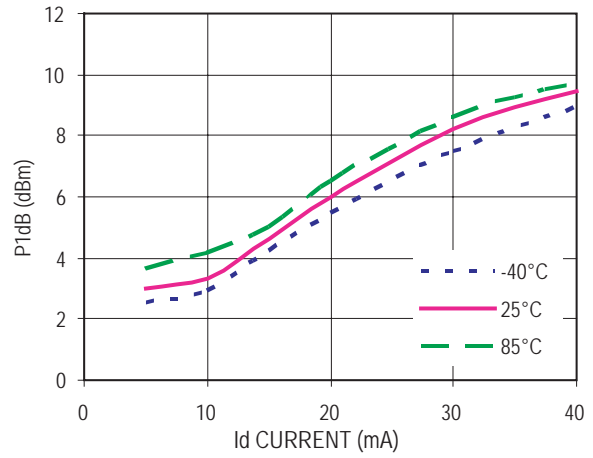

Figure 23. Gain vs Current and Temperature (Freq = 600 MHz)



**Figure 24. Input Third Order Intercept Point vs Current and Temperature (Freq = 600 MHz)**



**Figure 25. Output Power at 1dB Compression vs Current and Temperature (Freq = 600 MHz)**

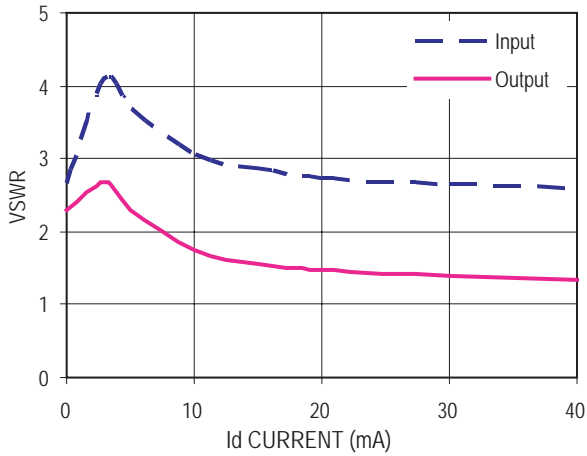

**Figure 26. Input and Output VSWR vs Current (Freq = 600 MHz)**

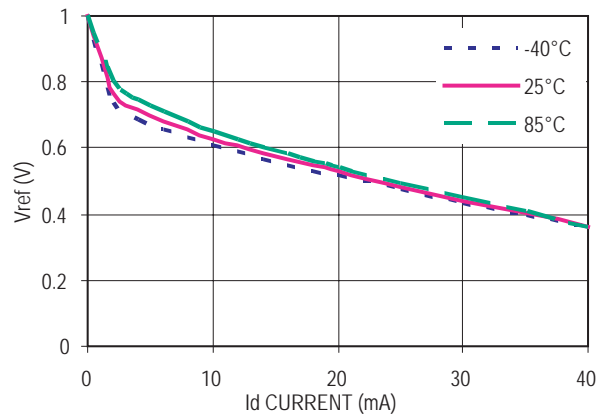

**Figure 27. Vref vs Current and Temperature**



### MGA-785T6 Typical Scattering Parameters ( LNA Off / Switch ON ),

Tc = 25°C, Zo = 50ohm, Vd = 3V, Id = 0mA, Vref = -3.0V (Test circuit of Figure 1b)

Freq GHz	S11		S21			S12		S22	
	Mag	Ang	dB	Mag	Ang	Mag	Ang	Mag	Ang
0.1	0.98	-12.90	-14.11	0.20	73.30	0.20	73.40	0.94	-16.30
0.2	0.90	-22.20	-10.37	0.30	63.40	0.30	63.50	0.85	-25.20
0.3	0.83	-31.60	-7.79	0.41	53.50	0.41	53.60	0.76	-34.20
0.4	0.76	-40.90	-5.78	0.51	43.60	0.51	43.70	0.67	-43.10
0.5	0.68	-50.20	-4.15	0.62	33.70	0.62	33.80	0.58	-52.00
0.6	0.63	-55.00	-3.74	0.65	29.00	0.65	29.10	0.53	-55.50
0.7	0.58	-59.80	-3.34	0.68	24.40	0.68	24.40	0.49	-59.00
0.8	0.52	-64.50	-2.96	0.71	19.70	0.71	19.80	0.44	-62.50
0.9	0.47	-69.30	-2.59	0.74	15.00	0.74	15.10	0.40	-66.00
1.0	0.43	-72.10	-2.43	0.76	11.60	0.76	11.70	0.37	-68.40
1.5	0.31	-82.30	-2.01	0.79	-1.30	0.79	-1.20	0.26	-76.60
1.9	0.26	-87.70	-1.88	0.81	-9.10	0.80	-9.00	0.22	-79.50
2.0	0.24	-88.20	-1.82	0.81	-9.40	0.81	-9.30	0.21	-80.70
2.5	0.18	-89.90	-1.74	0.82	-17.50	0.82	-17.40	0.17	-86.80
3.0	0.16	-94.60	-1.72	0.82	-24.40	0.83	-24.30	0.14	-90.70
3.5	0.15	-99.30	-1.71	0.82	-33.90	0.84	-33.80	0.12	-94.70
4.0	0.15	-105.20	-1.70	0.82	-41.70	0.85	-41.60	0.11	-99.10
4.5	0.12	-110.00	-1.71	0.82	-50.50	0.85	-50.40	0.09	-104.60
5.0	0.13	-116.50	-1.73	0.82	-57.30	0.85	-57.30	0.07	-110.00
5.5	0.12	-125.40	-1.77	0.82	-63.30	0.84	-63.20	0.07	-116.70
6.0	0.11	-139.90	-1.79	0.81	-71.80	0.82	-71.70	0.07	171.70
7.0	0.13	-168.00	-1.96	0.80	-86.30	0.80	-86.30	0.07	159.90
8.0	0.23	170.50	-2.19	0.78	-100.10	0.78	-100.00	0.13	151.80
9.0	0.32	154.10	-2.62	0.74	-116.00	0.74	-115.90	0.17	142.10
10.0	0.43	137.20	-3.15	0.70	-131.70	0.70	-131.60	0.24	132.00

## MGA-785T6 Typical Scattering Parameters and Noise Parameters,

Tc = 25°C, Zo = 50ohm, Vd = 3V, Id = 5mA, Vref = -0.7V (Test circuit of Figure 1b)

Freq GHz	S11		S21			S12		S22	
	Mag	Ang	dB	Mag	Ang	Mag	Ang	Mag	Ang
0.1	0.82	-8.30	12.58	4.26	173.60	0.05	19.60	0.58	-7.10
0.2	0.81	-12.20	12.49	4.21	170.90	0.05	19.90	0.57	-8.60
0.3	0.79	-16.10	12.40	4.17	168.20	0.05	20.20	0.57	-10.00
0.4	0.78	-19.90	12.31	4.13	165.40	0.06	20.40	0.57	-11.50
0.5	0.77	-23.80	12.22	4.08	162.70	0.06	20.70	0.56	-12.90
0.6	0.76	-27.70	12.13	4.04	160.00	0.06	21.60	0.56	-15.00
0.7	0.75	-31.60	12.04	4.00	157.30	0.06	22.50	0.56	-17.10
0.8	0.74	-35.50	11.95	3.96	154.50	0.06	23.30	0.55	-19.20
0.9	0.73	-39.40	11.85	3.91	151.80	0.07	24.20	0.55	-21.30
1.0	0.72	-42.80	11.77	3.88	149.10	0.07	25.30	0.55	-23.70
1.5	0.70	-58.60	11.32	3.68	136.20	0.08	27.60	0.54	-35.10
1.9	0.68	-70.80	10.96	3.53	126.40	0.09	28.70	0.53	-43.10
2.0	0.68	-71.80	10.83	3.48	125.40	0.09	29.50	0.52	-49.30
2.5	0.67	-83.50	10.29	3.27	116.20	0.11	26.50	0.50	-61.30
3.0	0.65	-100.20	10.22	3.25	105.60	0.13	23.10	0.49	-73.30
3.5	0.63	-116.90	10.22	3.24	90.80	0.15	14.40	0.46	-85.10
4.0	0.60	-136.80	9.52	2.99	77.00	0.16	6.00	0.43	-97.40
4.5	0.57	-150.00	8.72	2.73	65.30	0.17	-1.00	0.39	-108.90
5.0	0.57	-163.70	8.12	2.55	53.40	0.17	-8.10	0.35	-127.20
5.5	0.57	-179.80	7.65	2.41	43.90	0.17	-13.40	0.30	-129.30
5.7	0.58	174.20	7.39	2.34	40.20	0.17	-15.40	0.27	-137.80
6.0	0.58	165.90	7.33	2.33	35.10	0.17	-18.00	0.22	-146.80
7.0	0.63	141.40	5.69	1.93	13.60	0.18	-32.10	0.27	171.80
8.0	0.65	120.10	4.52	1.68	-1.60	0.18	-39.30	0.31	146.70
9.0	0.68	103.50	3.26	1.46	-17.70	0.17	-48.00	0.34	128.80
10.0	0.71	90.20	2.19	1.29	-31.50	0.17	-54.60	0.38	116.20

Freq GHz	Fmin dB	Γopt		Rn / 50
		Mag	Ang	
0.1	1.44	0.23	4.70	0.27
0.5	1.51	0.22	26.10	0.27
1.0	1.60	0.23	54.50	0.27
1.5	1.69	0.25	82.00	0.27
2.0	1.78	0.27	107.20	0.27
2.5	1.99	0.30	116.80	0.27
3.0	2.26	0.32	130.90	0.26
3.5	2.31	0.34	150.70	0.24
4.0	2.36	0.37	163.90	0.22
4.5	2.40	0.39	177.00	0.19
5.0	2.45	0.41	-164.30	0.17
5.5	2.52	0.44	-154.20	0.16
6.0	2.59	0.47	-145.10	0.15

Note :

1. Fmin values at 2 GHz and higher are based on measurements while the Fmin below 2 GHz have been extrapolated. The Fmin values are based on a set of 16 noise figure measurements made at 16 different impedances using an ATN NP5 test system. From these measurements a true Fmin is calculated.

## MGA-785T6 Typical Scattering Parameters and Noise Parameters,

Tc = 25°C, Zo = 50ohm, Vd = 3V, Id = 10mA, Vref = -0.63V (Test circuit of Figure 1b)

Freq GHz	S11		S21			S12		S22	
	Mag	Ang	dB	Mag	Ang	Mag	Ang	Mag	Ang
0.1	0.78	-9.70	15.14	5.72	173.10	0.05	18.90	0.46	-9.20
0.2	0.77	-13.90	15.04	5.65	170.20	0.05	19.20	0.46	-10.60
0.3	0.75	-18.10	14.93	5.58	167.40	0.05	19.40	0.46	-12.00
0.4	0.74	-22.20	14.83	5.51	164.50	0.05	19.70	0.45	-13.40
0.5	0.73	-26.40	14.72	5.45	161.60	0.05	19.90	0.45	-14.80
0.6	0.72	-30.70	14.62	5.38	158.70	0.05	20.70	0.44	-17.20
0.7	0.71	-35.00	14.51	5.32	155.90	0.06	21.50	0.44	-19.50
0.8	0.70	-39.20	14.40	5.25	153.00	0.06	22.20	0.44	-21.90
0.9	0.69	-43.50	14.30	5.19	150.10	0.06	23.00	0.43	-24.20
1.0	0.68	-47.10	14.20	5.13	147.30	0.06	23.90	0.43	-26.70
1.5	0.66	-64.50	13.65	4.81	133.80	0.07	25.70	0.42	-39.30
1.9	0.64	-77.70	13.20	4.57	123.70	0.08	26.60	0.40	-47.90
2.0	0.64	-80.20	13.09	4.52	122.20	0.08	27.10	0.40	-52.80
2.5	0.63	-91.00	12.47	4.20	112.70	0.10	24.10	0.39	-64.70
3.0	0.61	-108.40	12.25	4.10	101.70	0.11	20.90	0.37	-77.00
3.5	0.59	-126.10	12.07	4.01	87.20	0.13	13.00	0.35	-89.40
4.0	0.56	-146.00	11.22	3.64	74.30	0.13	6.20	0.33	-102.80
4.5	0.54	-159.80	10.42	3.32	63.00	0.13	0.60	0.29	-115.40
5.0	0.54	-172.40	9.71	3.06	51.00	0.14	-3.50	0.26	-134.80
5.5	0.54	172.00	9.17	2.87	42.30	0.14	-9.00	0.21	-142.00
5.7	0.55	166.10	8.91	2.79	38.90	0.14	-10.20	0.20	-153.30
6.0	0.57	157.50	8.84	2.77	33.50	0.14	-12.60	0.16	-157.10
7.0	0.61	135.60	7.05	2.25	12.50	0.15	-21.30	0.24	157.70
8.0	0.65	115.50	5.83	1.96	-2.00	0.15	-28.80	0.31	135.60
9.0	0.68	99.80	4.51	1.68	-17.60	0.15	-36.10	0.35	120.00
10.0	0.72	87.20	3.39	1.48	-31.10	0.15	-41.80	0.40	108.80

Freq GHz	Fmin dB	Γopt		Rn / 50
		Mag	Ang	
0.1	1.22	0.18	6.90	0.21
0.5	1.29	0.17	28.30	0.21
1.0	1.38	0.18	56.70	0.21
1.5	1.47	0.20	84.20	0.21
2.0	1.56	0.22	109.40	0.21
2.5	1.72	0.24	120.00	0.21
3.0	1.89	0.27	134.20	0.21
3.5	2.03	0.31	164.70	0.20
4.0	2.10	0.34	176.40	0.18
4.5	2.17	0.36	-172.00	0.16
5.0	2.22	0.39	-157.00	0.15
5.5	2.29	0.42	-146.90	0.14
6.0	2.36	0.45	-137.80	0.13

Note :

1. Fmin values at 2 GHz and higher are based on measurements while the Fmin below 2 GHz have been extrapolated. The Fmin values are based on a set of 16 noise figure measurements made at 16 different impedances using an ATN NP5 test system. From these measurements a true Fmin is calculated.

## MGA-785T6 Typical Scattering Parameters and Noise Parameters,

Tc = 25°C, Zo = 50ohm, Vd = 3V, Id = 20mA, Vref = -0.53V (Test circuit of Figure 1b)

Freq GHz	S11		S21			S12		S22	
	Mag	Ang	dB	Mag	Ang	Mag	Ang	Mag	Ang
0.1	0.75	-10.90	16.89	6.99	172.70	0.04	18.10	0.37	-11.60
0.2	0.73	-15.30	16.77	6.90	169.70	0.04	18.40	0.37	-12.90
0.3	0.72	-19.70	16.66	6.81	166.70	0.04	18.70	0.36	-14.10
0.4	0.70	-24.10	16.54	6.72	163.70	0.05	19.00	0.36	-15.40
0.5	0.69	-28.50	16.42	6.62	160.70	0.05	19.30	0.35	-16.60
0.6	0.68	-33.10	16.30	6.54	157.70	0.05	20.10	0.35	-19.20
0.7	0.67	-37.70	16.19	6.45	154.70	0.05	20.80	0.35	-21.80
0.8	0.66	-42.20	16.07	6.36	151.60	0.05	21.60	0.34	-24.30
0.9	0.65	-46.80	15.95	6.27	148.60	0.05	22.30	0.34	-26.90
1.0	0.64	-50.80	15.83	6.19	145.70	0.06	23.30	0.34	-29.70
1.5	0.62	-69.40	15.20	5.75	131.70	0.07	25.00	0.33	-43.20
1.9	0.60	-83.30	14.68	5.42	121.30	0.08	26.00	0.32	-52.40
2.0	0.60	-84.40	14.59	5.36	120.60	0.08	26.30	0.31	-55.50
2.5	0.59	-97.00	13.89	4.95	109.80	0.09	23.50	0.29	-67.00
3.0	0.57	-115.00	13.52	4.74	98.70	0.10	20.60	0.28	-79.40
3.5	0.55	-133.40	13.21	4.58	84.40	0.11	13.50	0.25	-92.40
4.0	0.53	-153.30	12.27	4.11	72.10	0.11	7.80	0.23	-107.60
4.5	0.51	-167.40	11.46	3.74	61.30	0.12	3.30	0.21	-122.00
5.0	0.51	-178.80	10.68	3.42	49.40	0.12	-0.80	0.19	-142.00
5.5	0.52	166.00	10.10	3.20	41.50	0.12	-4.90	0.15	-156.80
5.7	0.53	160.30	9.86	3.11	38.40	0.12	-5.80	0.15	-171.70
6.0	0.54	151.40	9.78	3.08	32.60	0.13	-8.20	0.12	178.20
7.0	0.59	131.80	7.92	2.49	12.40	0.13	-16.40	0.21	145.80
8.0	0.64	112.70	6.73	2.17	-1.50	0.14	-22.00	0.29	127.30
9.0	0.68	97.80	5.44	1.87	-16.80	0.14	-28.70	0.34	114.40
10.0	0.71	85.70	4.32	1.65	-30.30	0.15	-34.30	0.39	104.90

Freq GHz	Fmin dB	Γopt		Rn / 50
		Mag	Ang	
0.1	1.14	0.14	7.70	0.19
0.5	1.21	0.13	29.10	0.19
1.0	1.30	0.14	57.50	0.19
1.5	1.39	0.16	85.00	0.19
2.0	1.48	0.18	110.20	0.19
2.5	1.61	0.21	132.40	0.19
3.0	1.83	0.25	151.50	0.19
3.5	1.90	0.28	168.00	0.18
4.0	1.97	0.32	-177.70	0.17
4.5	2.04	0.35	-165.20	0.15
5.0	2.11	0.38	-154.00	0.14
5.5	2.18	0.41	-143.90	0.13
6.0	2.25	0.44	-134.80	0.12

Note :

1. Fmin values at 2 GHz and higher are based on measurements while the Fmin below 2 GHz have been extrapolated. The Fmin values are based on a set of 16 noise figure measurements made at 16 different impedances using an ATN NP5 test system. From these measurements a true Fmin is calculated.

## MGA-785T6 Typical Scattering Parameters and Noise Parameters,

Tc = 25°C, Zo = 50ohm, Vd = 3V, Id = 40mA, Vref = -0.36V (Test circuit of Figure 1b)

Freq	S11	S21	S12	S22					
GHz	Mag	Ang	dB	Mag	Ang	Mag	Ang	Mag	Ang
0.1	0.73	-11.40	17.85	7.80	172.50	0.04	17.40	0.32	-13.30
0.2	0.71	-16.00	17.72	7.69	169.40	0.04	17.70	0.31	-14.30
0.3	0.70	-20.50	17.60	7.59	166.40	0.04	18.00	0.31	-15.30
0.4	0.69	-25.10	17.47	7.48	163.30	0.04	18.30	0.30	-16.20
0.5	0.67	-29.60	17.34	7.37	160.20	0.04	18.60	0.30	-17.20
0.6	0.66	-34.30	17.22	7.26	157.10	0.04	19.40	0.30	-19.80
0.7	0.65	-39.10	17.09	7.16	154.10	0.05	20.10	0.29	-22.40
0.8	0.64	-43.80	16.97	7.05	151.00	0.05	20.90	0.29	-24.90
0.9	0.63	-48.50	16.84	6.95	147.90	0.05	21.60	0.29	-27.50
1.0	0.63	-52.60	16.71	6.85	145.00	0.05	22.60	0.28	-30.30
1.5	0.60	-71.70	16.03	6.33	130.80	0.06	24.80	0.27	-43.90
1.9	0.59	-86.00	15.47	5.94	120.30	0.07	26.10	0.27	-52.90
2.0	0.58	-86.90	15.38	5.87	119.40	0.07	26.30	0.26	-54.80
2.5	0.57	-99.70	14.63	5.39	108.60	0.08	24.10	0.25	-65.30
3.0	0.55	-117.70	14.20	5.13	97.60	0.09	21.70	0.23	-77.10
3.5	0.54	-136.10	13.83	4.92	83.60	0.10	15.30	0.21	-90.10
4.0	0.52	-155.80	12.86	4.40	71.80	0.10	10.30	0.19	-105.40
4.5	0.50	-170.20	12.06	4.01	61.10	0.11	6.30	0.16	-120.70
5.0	0.50	178.80	11.26	3.66	49.10	0.11	2.00	0.15	-140.80
5.5	0.51	163.80	10.67	3.42	41.70	0.11	-1.20	0.12	-162.00
5.7	0.53	158.20	10.44	3.33	38.50	0.11	-2.00	0.12	170.60
6.0	0.54	149.20	10.34	3.29	32.70	0.12	-4.50	0.10	163.90
7.0	0.58	130.50	8.46	2.65	12.90	0.12	-12.60	0.19	141.30
8.0	0.63	111.80	7.31	2.32	-0.80	0.13	-17.30	0.27	124.00
9.0	0.67	97.40	6.05	2.01	-15.80	0.13	-23.90	0.32	112.60
10.0	0.71	85.50	4.96	1.77	-29.40	0.14	-29.40	0.37	104.30

Freq	Fmin	Γopt		Rn / 50
		Mag	Ang	
GHz	dB			
0.1	1.08	0.13	12.00	0.18
0.5	1.15	0.12	33.40	0.18
1.0	1.24	0.13	61.80	0.18
1.5	1.33	0.15	89.30	0.18
2.0	1.42	0.17	114.50	0.18
2.5	1.52	0.20	137.30	0.18
3.0	1.60	0.24	156.60	0.17
3.5	1.66	0.27	176.90	0.16
4.0	1.73	0.30	-171.40	0.15
4.5	1.80	0.33	-158.80	0.14
5.0	1.88	0.37	-147.60	0.13
5.5	1.95	0.40	-137.50	0.12
6.0	2.02	0.43	-128.40	0.11

Note :

1. Fmin values at 2 GHz and higher are based on measurements while the Fmin below 2 GHz have been extrapolated. The Fmin values are based on a set of 16 noise figure measurements made at 16 different impedances using an ATN NP5 test system. From these measurements a true Fmin is calculated.

## MGA-785T6 Typical Scattering Parameters ( LNA / Switch Power Off )

Tc = 25°C, Zo = 50ohm, Vd = 0V, Id = 0mA (Test circuit of Figure 1b)

Freq GHz	S11		S21			S12		S22	
	Mag	Ang	dB	Mag	Ang	Mag	Ang	Mag	Ang
0.1	0.99	-15.30	-34.42	0.02	77.90	0.02	80.40	0.81	178.70
0.2	0.96	-28.50	-29.63	0.03	71.00	0.03	73.10	0.81	177.60
0.3	0.92	-41.70	-26.56	0.05	64.20	0.05	65.70	0.81	176.50
0.4	0.89	-54.80	-24.29	0.06	57.30	0.06	58.40	0.81	175.40
0.5	0.85	-68.00	-22.50	0.08	50.40	0.08	51.00	0.81	174.30
0.6	0.83	-76.80	-21.72	0.08	46.20	0.08	46.70	0.81	173.10
0.7	0.80	-85.70	-21.11	0.09	42.00	0.09	42.40	0.81	171.90
0.8	0.77	-94.50	-20.45	0.10	37.70	0.10	38.10	0.82	170.70
0.9	0.75	-103.30	-19.91	0.10	33.50	0.10	33.80	0.82	169.50
1.0	0.73	-110.00	-19.58	0.11	30.40	0.11	30.70	0.82	168.20
1.5	0.67	-135.80	-18.56	0.12	19.00	0.12	19.30	0.81	161.60
1.9	0.65	-142.10	-18.27	0.12	12.90	0.12	13.10	0.81	156.30
2.0	0.64	-150.90	-18.06	0.13	11.00	0.13	11.30	0.81	152.20
2.5	0.61	-167.70	-17.59	0.13	5.40	0.13	5.50	0.80	145.00
3.0	0.61	178.70	-17.46	0.13	1.00	0.14	0.30	0.80	137.90
3.5	0.61	164.20	-17.39	0.14	-4.70	0.14	-3.50	0.79	130.20
4.0	0.62	154.70	-17.20	0.14	-7.10	0.14	-6.10	0.81	125.90
4.5	0.63	142.80	-16.95	0.14	-9.70	0.14	-7.40	0.83	116.50
5.0	0.63	134.40	-16.77	0.15	-12.50	0.15	-9.80	0.84	111.30
5.5	0.64	127.70	-16.65	0.15	-14.80	0.15	-12.70	0.86	106.90
6.0	0.65	113.60	-16.48	0.15	-17.70	0.16	-15.50	0.88	97.00
7.0	0.68	101.90	-16.25	0.15	-21.80	0.16	-22.50	0.88	87.00
8.0	0.73	92.60	-15.92	0.16	-26.90	0.17	-25.70	0.88	81.20
9.0	0.75	82.30	-15.65	0.17	-31.10	0.17	-30.90	0.86	72.60
10.0	0.78	73.70	-15.19	0.17	-36.50	0.17	-36.30	0.85	65.10

## Package Dimensions

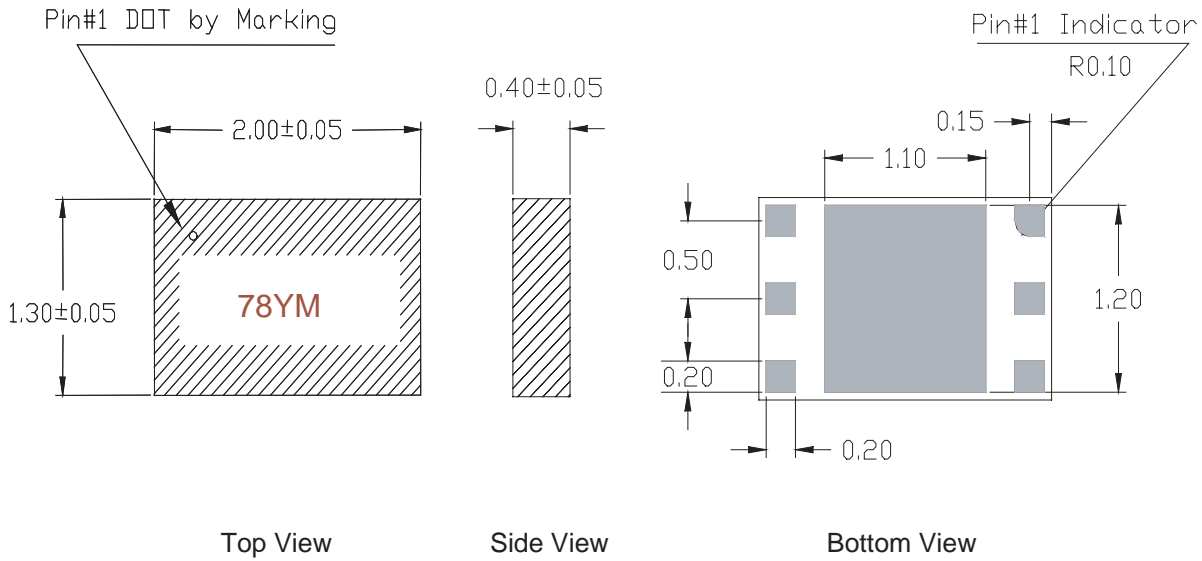

## Part Number Ordering Information

Part Number	No. of Devices	Container
MGA-785T6-BLKG	100	Antistatic bag
MGA-785T6-TR1G	3,000	7" Reel
MGA-785T6-TR2G	10,000	13" Reel

### PCB Land Patterns and Stencil Design

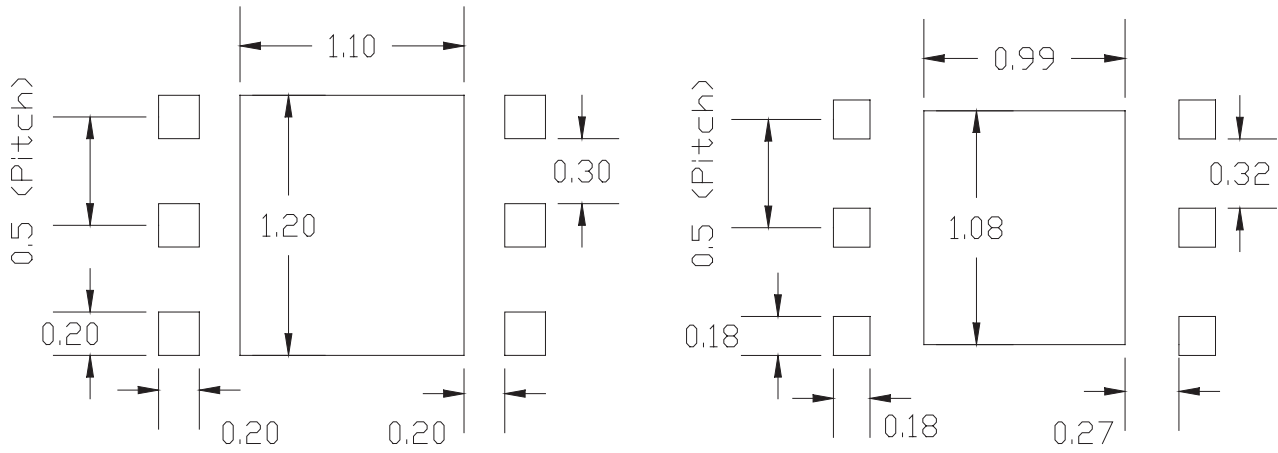

PCB Land Pattern (dimensions in mm)

Stencil Outline Drawing (dimensions in mm)

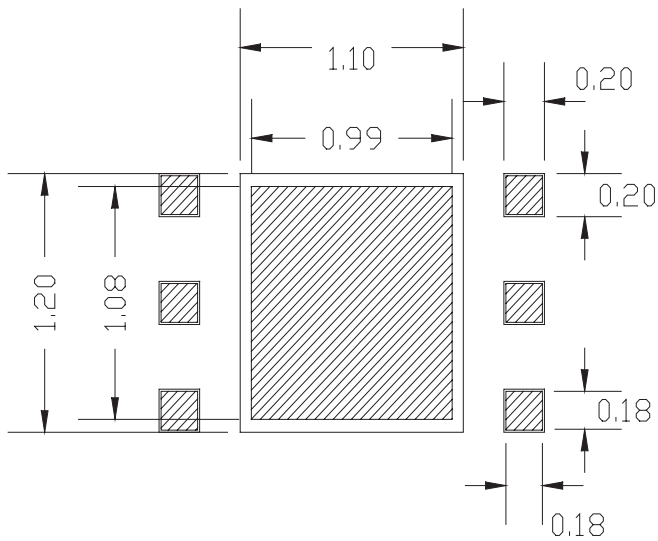

Combined PCB and Stencil Layouts (dimensions in mm)



## Device Orientation

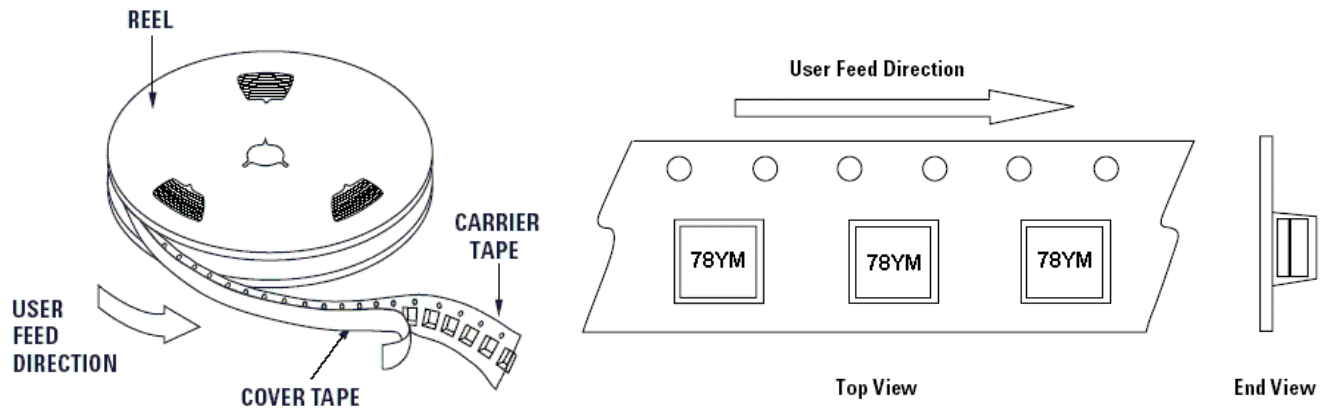

## Tape Dimensions

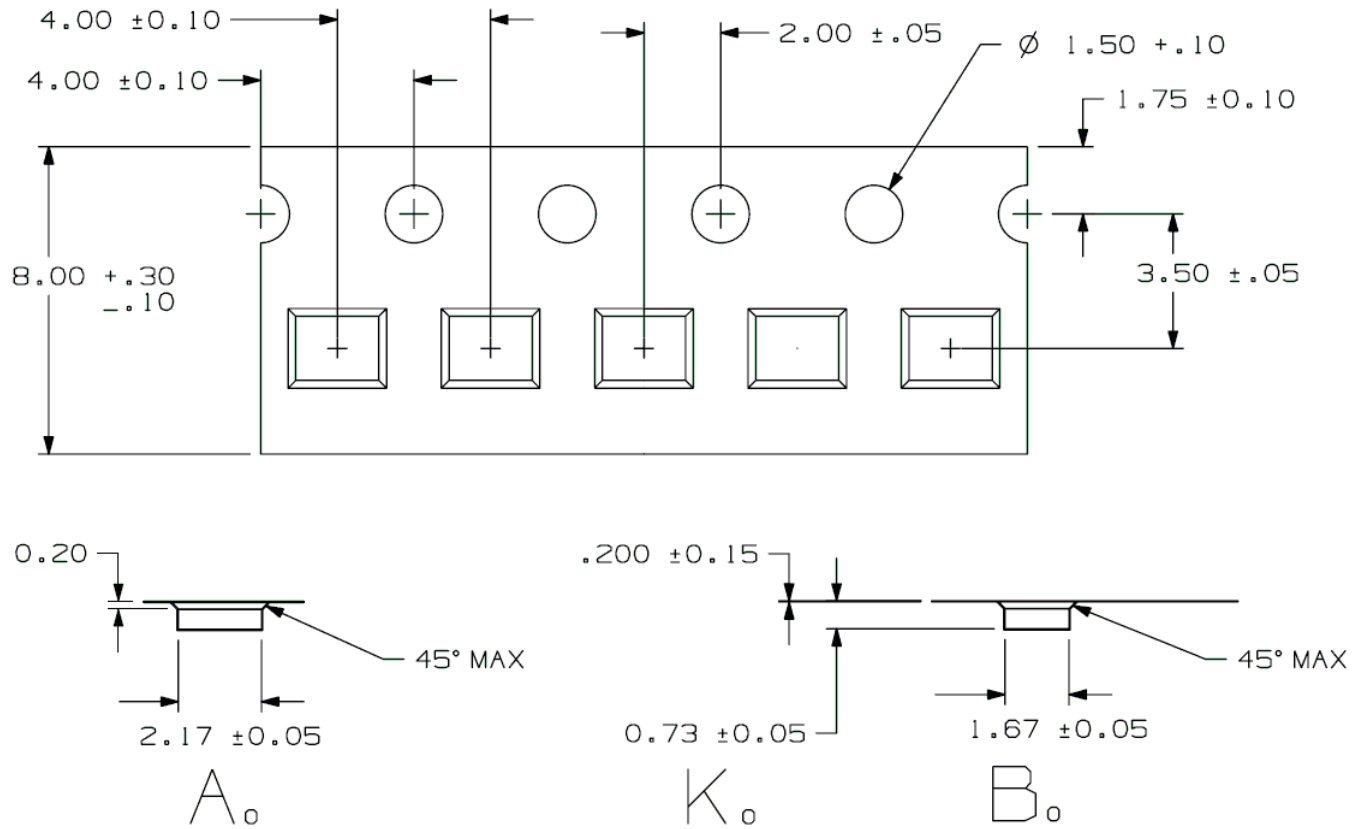

# Reel Dimensions

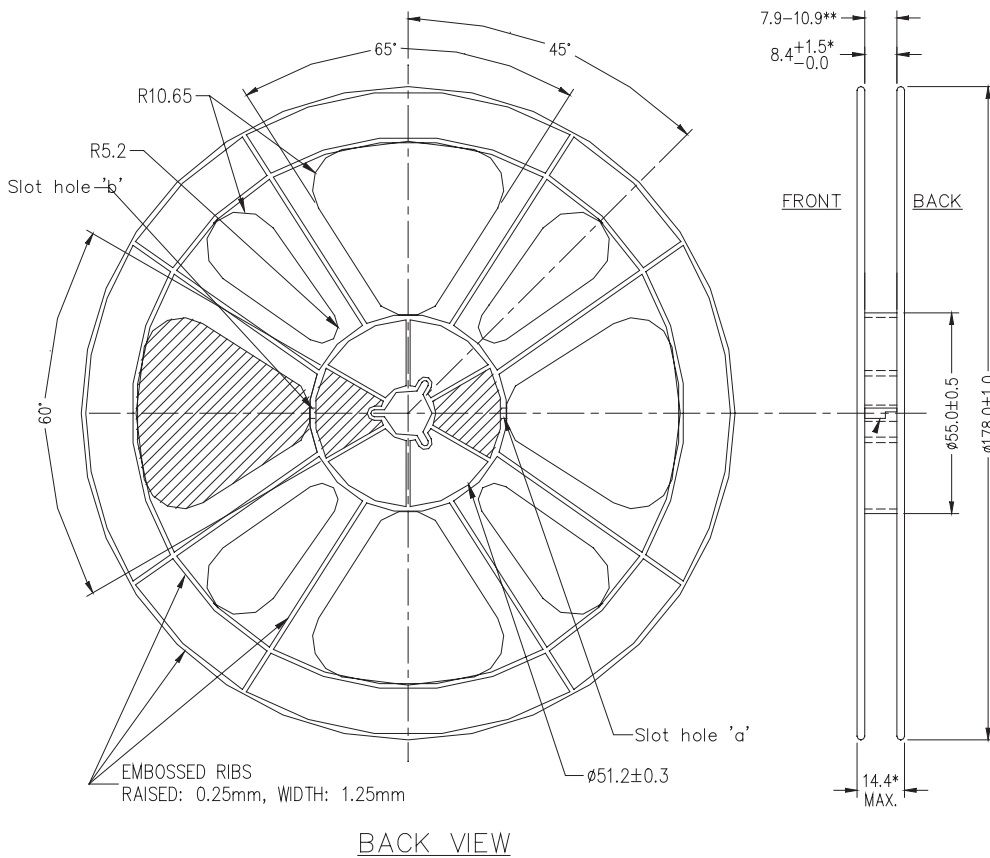
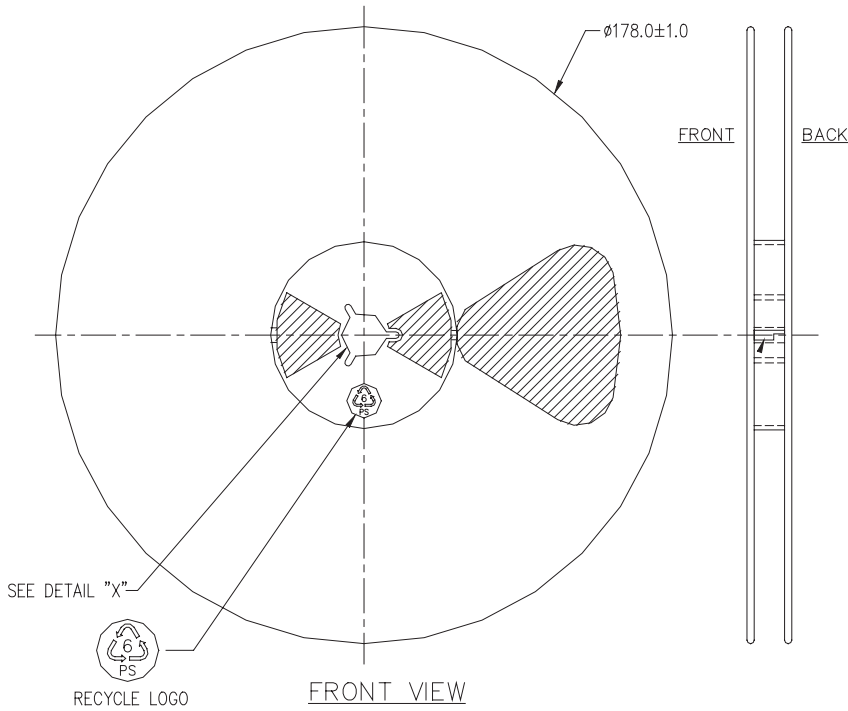

For product information and a complete list of distributors, please go to our web site: [www.avagotech.com](http://www.avagotech.com)

Avago, Avago Technologies, and the A logo are trademarks of Avago Technologies Limited in the United States and other countries. Data subject to change. Copyright © 2005-2008 Avago Technologies Limited. All rights reserved. AV02-0058EN - May 27, 2008

