

## Data Sheet

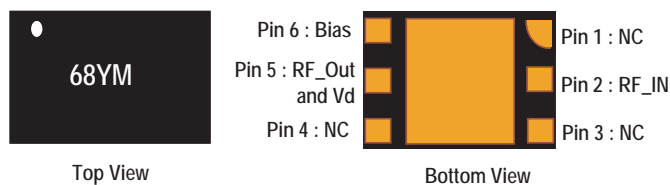
### Description

The MGA-685T6 is an easy-to-use GaAs MMIC amplifier that offer excellent linearity and low noise figure for application from 0.1 to 1.5 GHz. The device is housed in Ultra Thin Small Leadless Package (UTSLP) with 0.4mm package thickness.

One external resistor is used to set the bias current from 5 mA to 30 mA. This allows the designer to use the same part in several circuit positions and tailor the linearity performance (and current consumption) to suit each position.

The output of the amplifier is matched to 50Ω (below 2:1 VSWR) across the entire bandwidth and only requires minimum input matching. The amplifier allows a wide dynamic range by offering a 0.93 dB NF coupled with a +18.7 dBm Output IP3. The circuit uses state-of-the art E-pHEMT technology with proven reliability.

### Package Marking & Orientation



68 = Device Code  
Y = Year of manufacture  
M = Month of manufacture

### Features

- Single +3V supply
- High Linearity
- Low Noise figure
- Miniature Surface Mount 2.0x1.3x0.4 mm<sup>3</sup> 6-lead UTSLP

### Specifications at 500 MHz; 3V 10 mA (Typ.)

- 0.93 dB Noise Figure
- 18.7 dBm OIP3
- 18.9 dB Gain
- 17.3 dBm P1dB

### Applications

LNA for DVB-T, DVB-H, T-DMB, ISDB-T, DAB and MediaFLO

**Table 1. Absolute Maximum Rating** [1]

Symbol	Parameter	Units	Absolute Max.
Vd	Device Voltage (Pin 5) [2]	V	6
Id	Device Current (Pin 5) [2]	mA	100
P <sub>in,max</sub>	CW RF Input Power (Pin 2) [3]	dBm	+21
I <sub>ref</sub>	Bias Reference Current (Pin 6)	mA	12
P <sub>diss</sub>	Total Power Dissipation [4]	mW	600
T <sub>CH</sub>	Channel Temperature	°C	150
T <sub>STG</sub>	Storage Temperature	°C	150
θ <sub>ch_b</sub>	Thermal Resistance[5]	°C / W	97

Notes:

1. Operation of this device above any one of these parameters may cause permanent damage.
2. Bias is assumed DC quiescent conditions.
3. With the DC (typical bias) and RF applied to the device at board temperature T<sub>B</sub> = 25 °C.
4. Total dissipation power is referred to board temperature, T<sub>B</sub> = 92 °C, derate P<sub>diss</sub> at 10 mW/ °C for T<sub>B</sub> > 92 °C.
5. Thermal resistance is measured from junction to board using IR method.

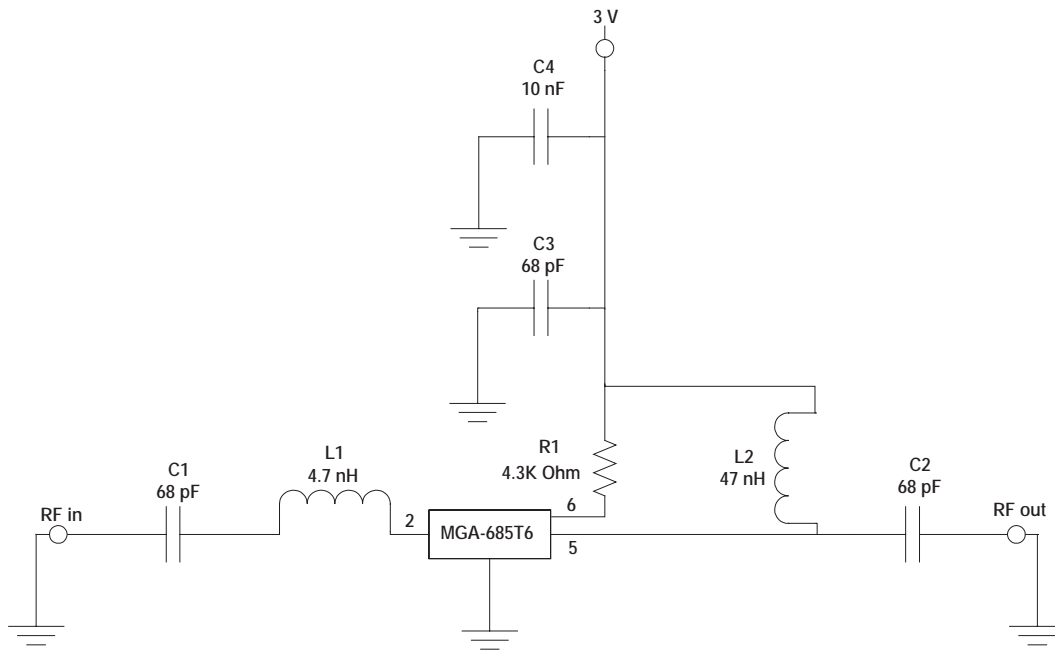
**Table 2. Electrical Specifications**

T<sub>A</sub> = 25 °C, Freq = 0.5 GHz, Vd = 3V (unless otherwise specified)

Symbol	Parameter	Units	Min.	Typ	Max.
Id [1,2]	Device Current	V	7	10	16
NF [1,2]	Noise Figure in test circuit	dB	-	0.93	1.50
Gain [1,2]	Associated Gain in test circuit	dB	17.50	18.90	20.50
OIP3 [1,2,3]	Output 3rd Order Intercept in test circuit	dBm	16.50	18.70	-
P1dB [1,2]	Output Power at 1dB Gain Compression in test circuit	dBm	-	17.30	-
IRL [1,2]	Input Return Loss in test circuit	dB	-	-8.10	-
ORL [1,2]	Output Return Loss in test circuit	dB	-	-16.40	-

Notes:

1. Circuit losses have been de-embedded from actual measurements.
2. Measurement in table 2 uses the test board and circuit schematic shows in figure 1a. Data based on 500 part sample size from two wafer lots during initial characterization of this product.
3. 0.5 GHz OIP3 Test Condition : F1 = 0.5 GHz, F2 = 0.505 GHz, Pin = -20 dBm



Circuit Symbol	Size	Description
C1, C2, C3	0402	68pF
C4	0603	10 nF
R1	0402	4.3 Kohm
L1	0402	4.7 nH
L2	0402	47 nH

Figure 1a. Test circuit of the 0.5GHz production test board used for NF, Gain and OIP3 measurements. This circuit achieves a trade-off between optimal NF, Gain, OIP3 and input return loss. Circuit losses have been de-embedded from actual measurements.

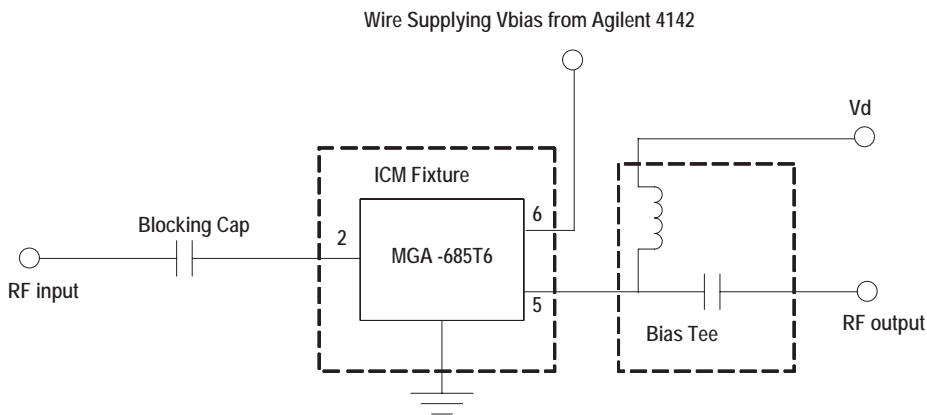


Figure 1b. A diagram showing the connection to the DUT during an S-parameter and Noise parameter measurement using an Automated Tuner System.

## Product Consistency Distribution Charts at 0.5 GHz, Vd = 3 V

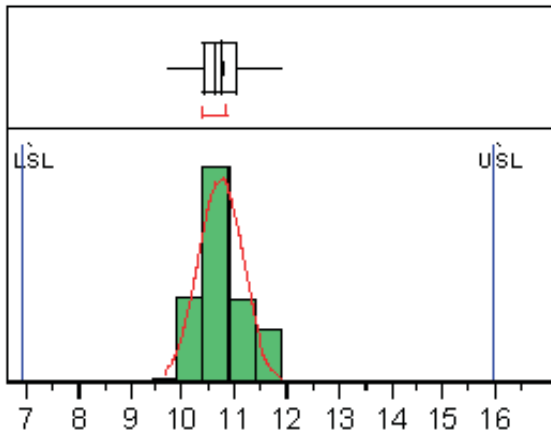


Figure 2. Id @ 3V, LSL=7.0, Nominal=10.7, USL=16.0

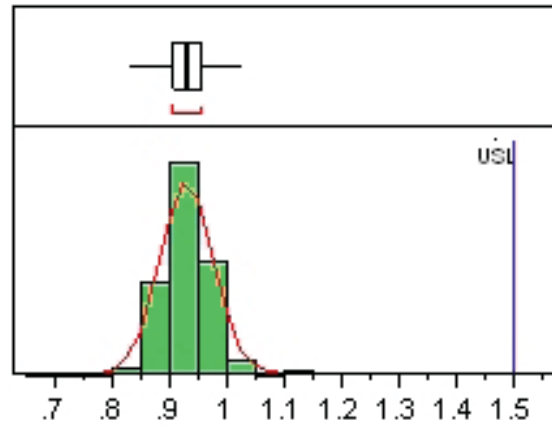


Figure 3. NF @ 0.5GHz 3V, Nominal=0.93, USL=1.50

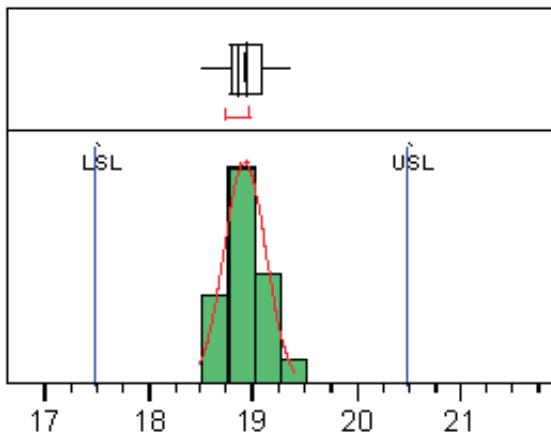


Figure 4. Gain @ 0.5GHz 3V, LSL=17.5, Nominal=18.9, USL=20.5

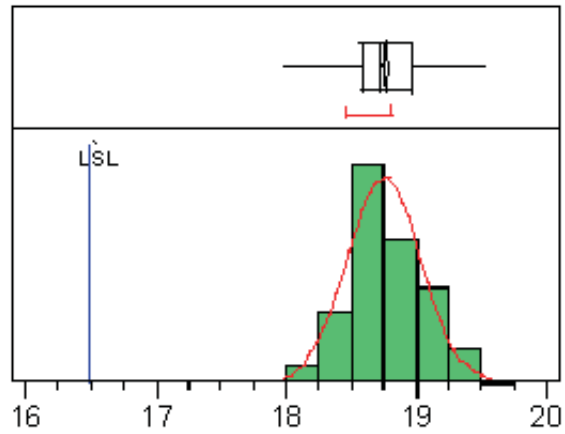
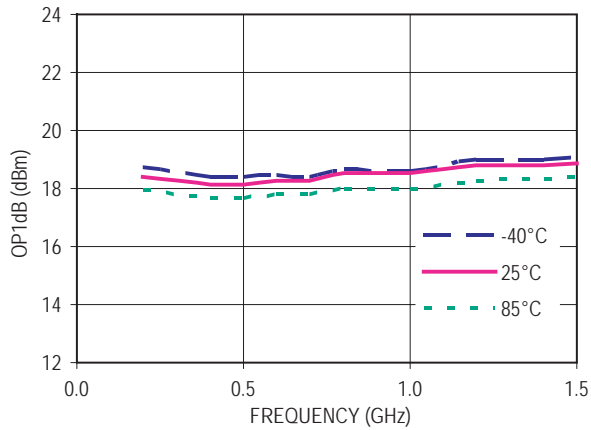


Figure 5. OIP3 @ 0.5GHz 3V, LSL=16.5, Nominal=18.7

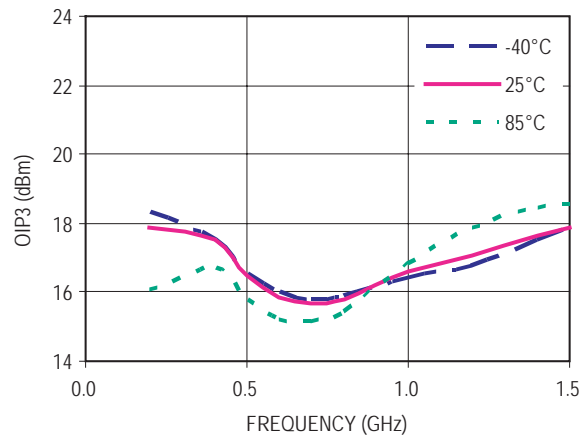
### Notes:

1. Measurement uses the test board and circuit schematics shows in Figure 1a.
2. Distribution data based on 500 part sample size from two wafer lots during initial characterization of this product. Future wafers allocated to this product may have nominal values anywhere between upper and lower limits.

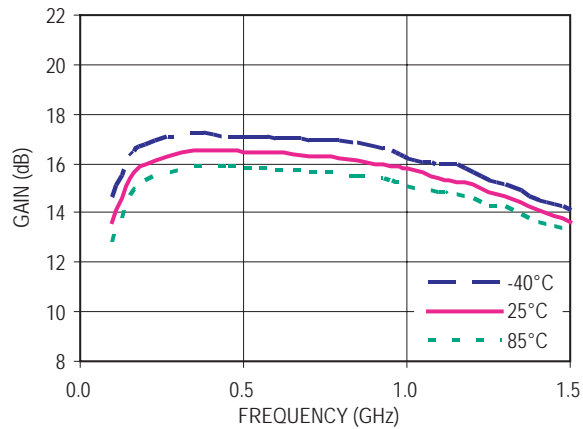
**MGA-685T6 Typical Performance,  $V_d = 3V$ ,  $I_{ds} = 5mA$ ,  $R_1 = 10K\Omega$  as measured in Fig 1a test circuit (unless specified otherwise)**



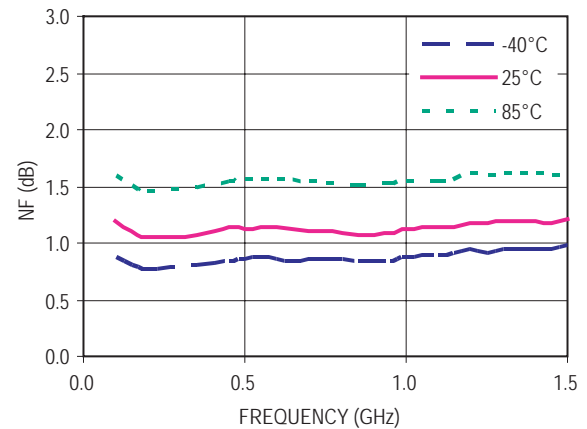
**Figure 6. OP1dB vs Frequency ( $V_d = 3V$ ,  $I_{ds} = 5mA$ )**



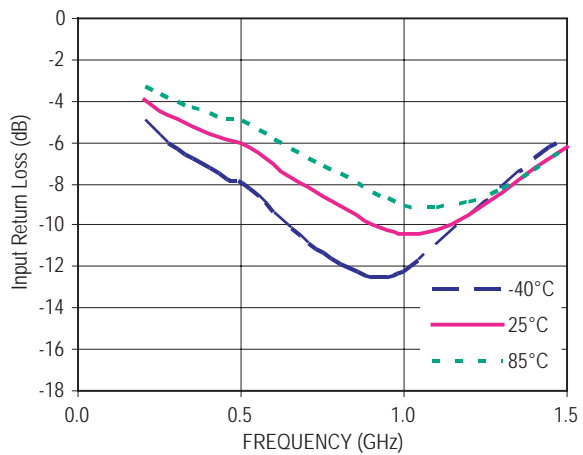
**Figure 7. OIP3 vs Frequency ( $V_d = 3V$ ,  $I_{ds} = 5mA$ )**



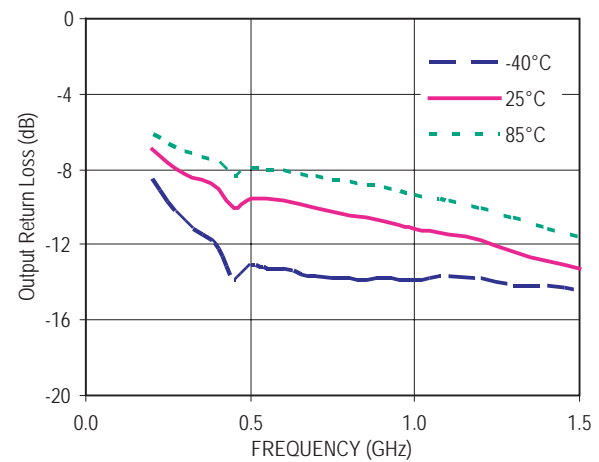
**Figure 8. Gain vs Frequency ( $V_d = 3V$ ,  $I_{ds} = 5mA$ )**



**Figure 9. NF vs Frequency ( $V_d = 3V$ ,  $I_{ds} = 5mA$ )**

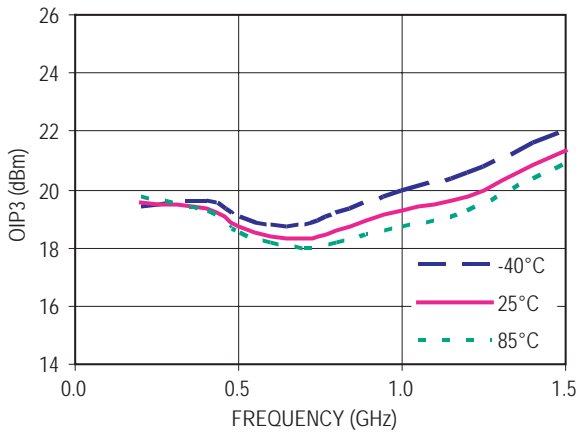


**Figure 10. Input Return Loss vs Frequency ( $V_d = 3V$ ,  $I_{ds} = 5mA$ )**

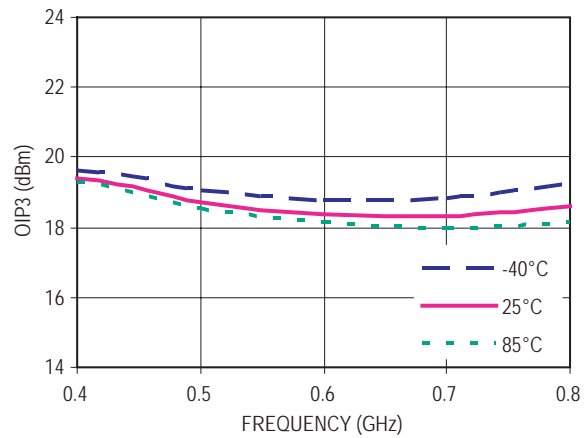


**Figure 11. Output Return Loss vs Frequency ( $V_d = 3V$ ,  $I_{ds} = 5mA$ )**

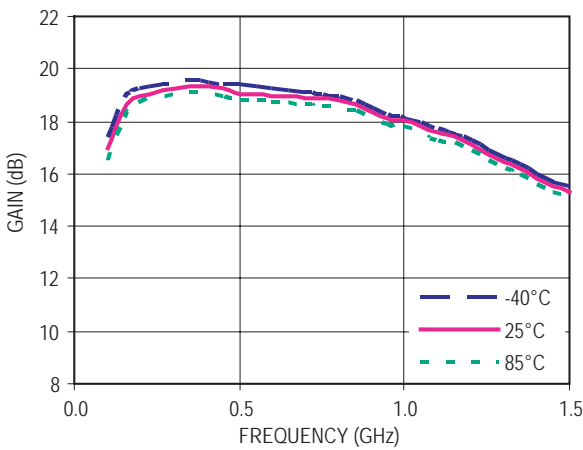
**MGA-685T6 Typical Performance,  $V_d = 3V$ ,  $I_{ds} = 10mA$ ,  $R_1 = 4.3K\Omega$  as measured in Fig 1a test circuit (unless specified otherwise)**



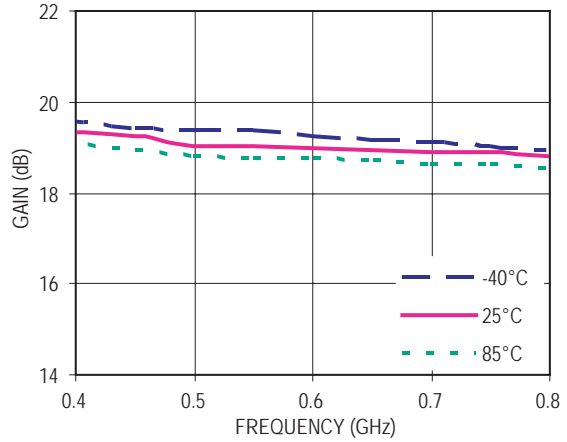
**Figure 12. OIP3 vs Frequency ( $V_d = 3V$ ,  $I_{ds} = 10mA$ )**



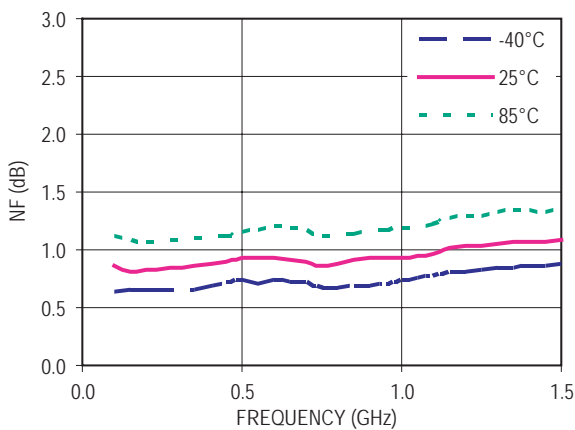
**Figure 13. OIP3 vs Frequency (0.4 – 0.8 GHz) ( $V_d = 3V$ ,  $I_{ds} = 10mA$ )**



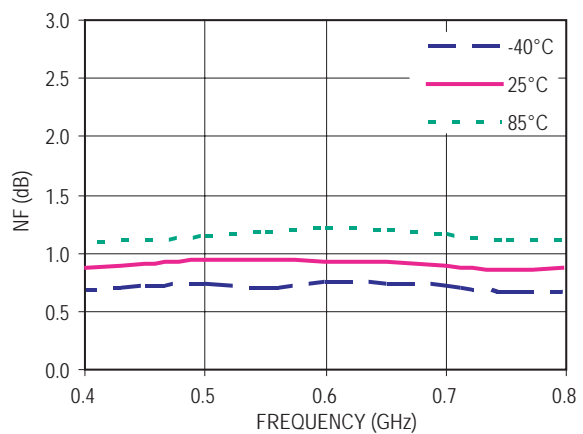
**Figure 14. Gain vs Frequency ( $V_d = 3V$ ,  $I_{ds} = 10mA$ )**



**Figure 15. Gain vs Frequency (0.4 – 0.8 GHz) ( $V_d = 3V$ ,  $I_{ds} = 10mA$ )**



**Figure 16. NF vs Frequency ( $V_d = 3V$ ,  $I_{ds} = 10mA$ )**



**Figure 17. NF vs Frequency (0.4 – 0.8 GHz) ( $V_d = 3V$ ,  $I_{ds} = 10mA$ )**

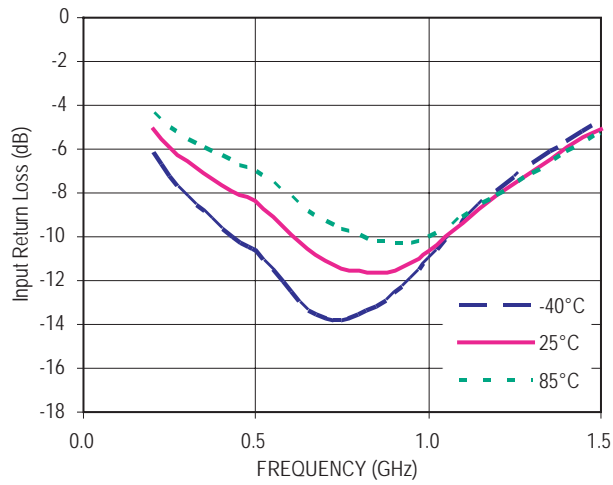


Figure 18. Input Return Loss vs Frequency (Vd = 3V, Ids = 10mA)

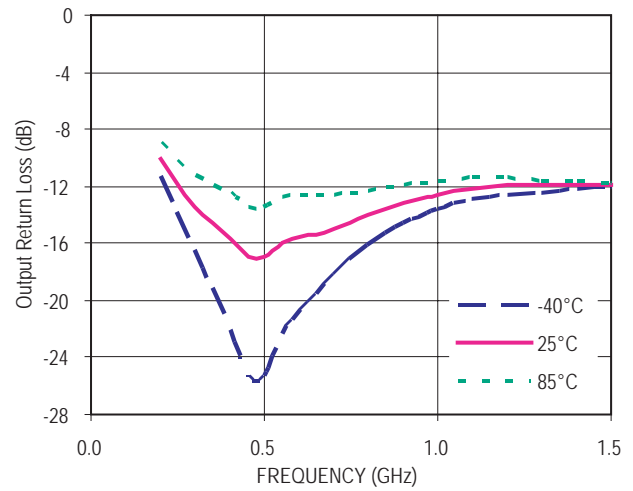


Figure 19. Output Return Loss vs Frequency (Vd = 3V, Ids = 10mA)

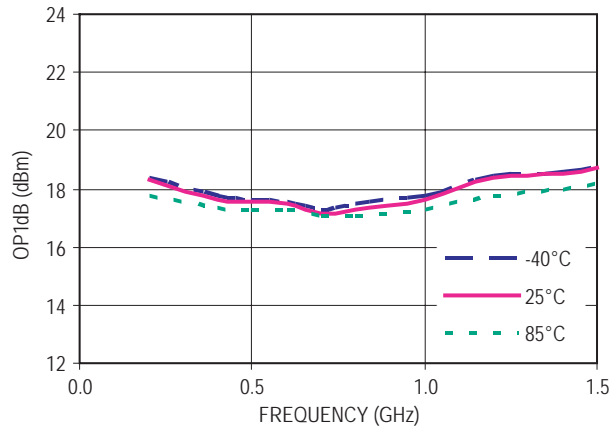
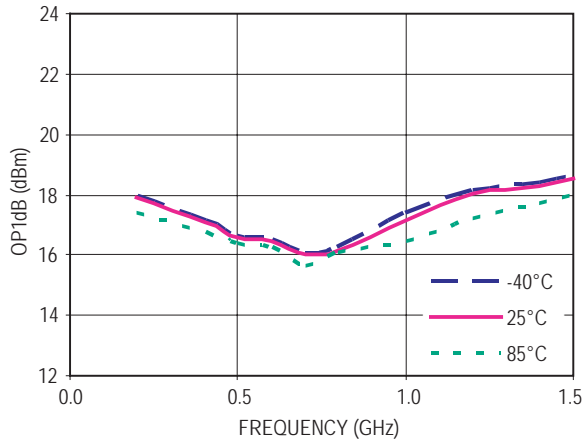
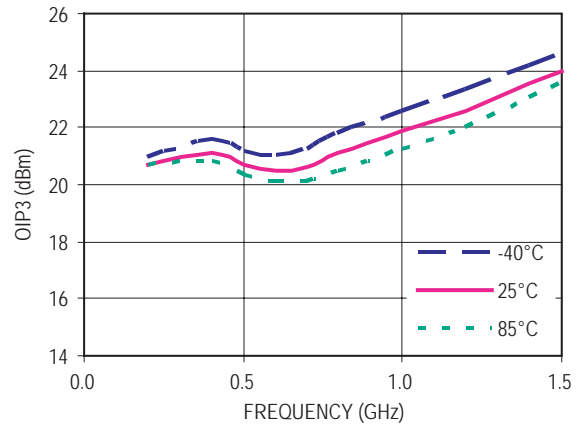


Figure 20. OP1dB vs Frequency (Vd = 3V, Ids = 10mA)

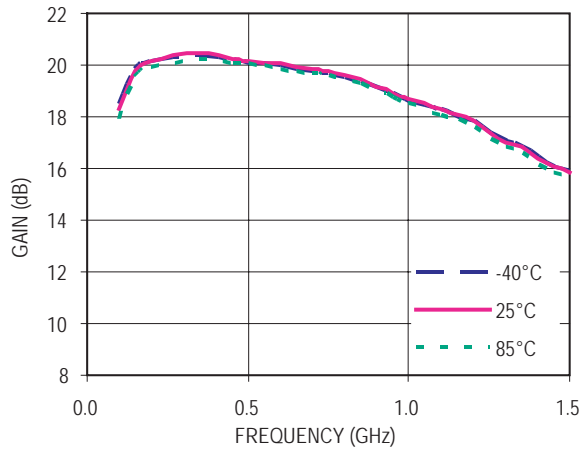
**MGA-685T6 Typical Performance,  $V_d = 3V$ ,  $I_{ds} = 15mA$ ,  $R_1 = 2.7K\Omega$  as measured in Fig 1a test circuit (unless specified otherwise)**



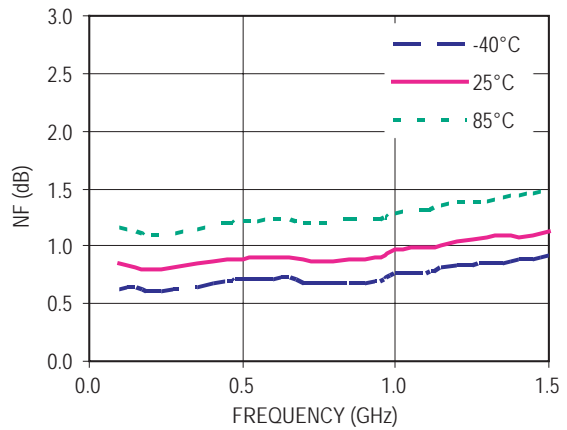
**Figure 21. OP1dB vs Frequency ( $V_d = 3V$ ,  $I_{ds} = 15mA$ )**



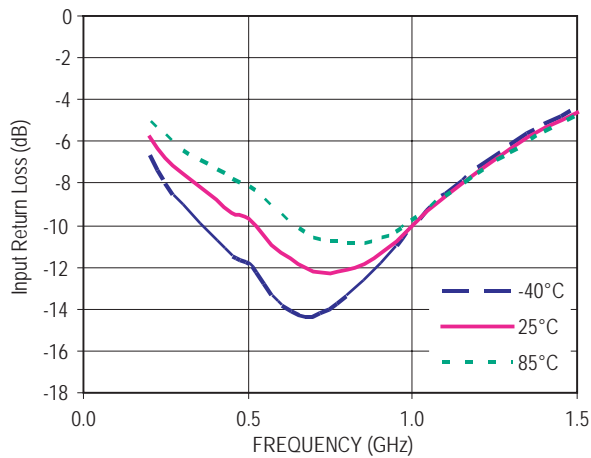
**Figure 22. OIP3 vs Frequency ( $V_d = 3V$ ,  $I_{ds} = 15mA$ )**



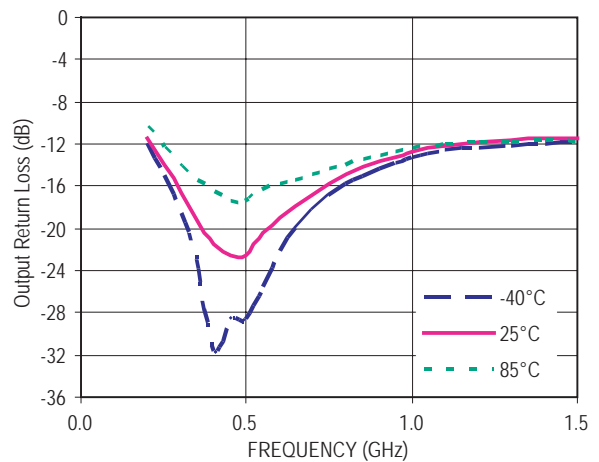
**Figure 23. Gain vs Frequency ( $V_d = 3V$ ,  $I_{ds} = 15mA$ )**



**Figure 24. NF vs Frequency ( $V_d = 3V$ ,  $I_{ds} = 15mA$ )**



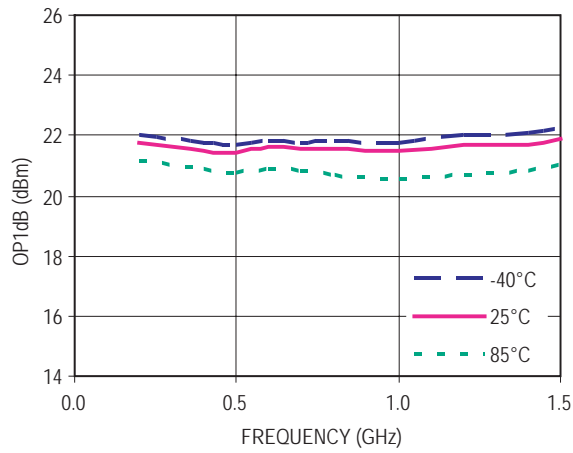
**Figure 25. Input Return Loss vs Frequency ( $V_d = 3V$ ,  $I_{ds} = 15mA$ )**



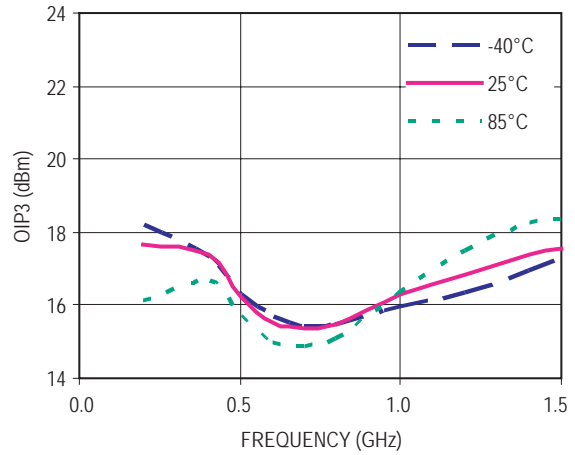
**Figure 26. Output Return Loss vs Frequency ( $V_d = 3V$ ,  $I_{ds} = 15mA$ )**



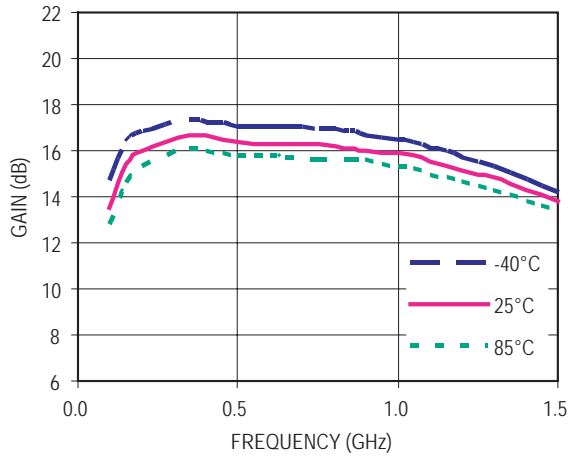
**MGA-685T6 Typical Performance,  $V_d = 5V$ ,  $I_{ds} = 5mA$ ,  $R_1 = 22K\Omega$  as measured in Fig 1a test circuit (unless specified otherwise)**



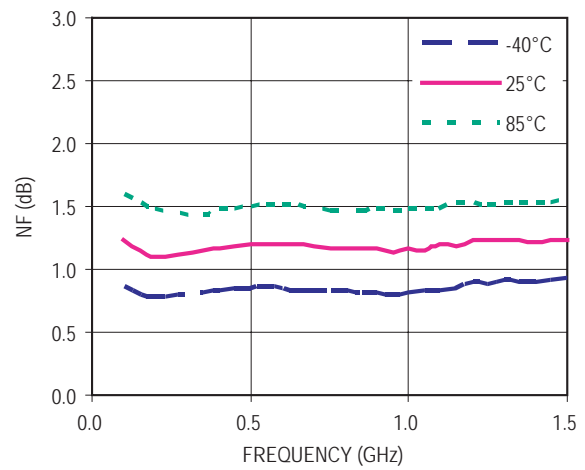
**Figure 27. OP1dB vs Frequency ( $V_d = 5V$ ,  $I_{ds} = 5mA$ )**



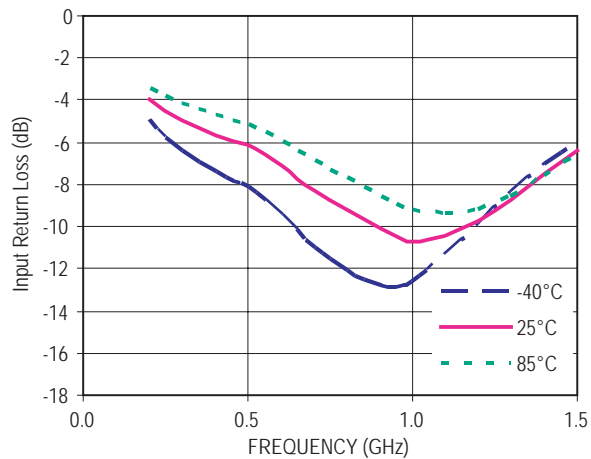
**Figure 28. OIP3 vs Frequency ( $V_d = 5V$ ,  $I_{ds} = 5mA$ )**



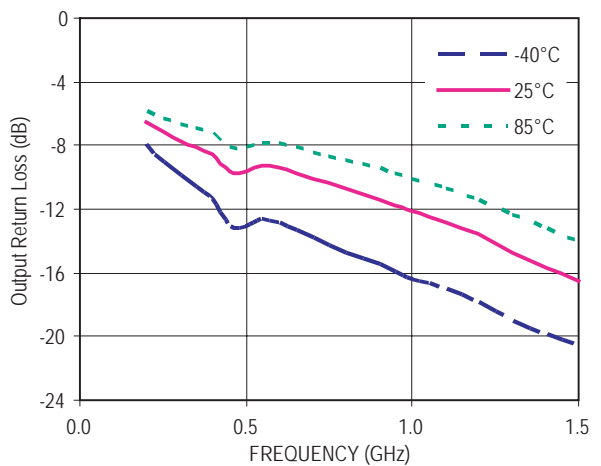
**Figure 29. Gain vs Frequency ( $V_d = 5V$ ,  $I_{ds} = 5mA$ )**



**Figure 30. NF vs Frequency ( $V_d = 5V$ ,  $I_{ds} = 5mA$ )**

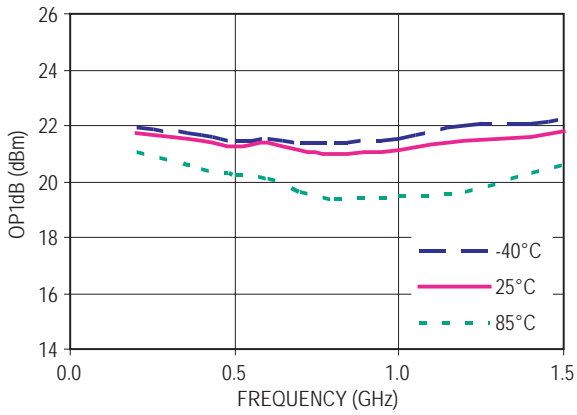


**Figure 31. Input Return Loss vs Frequency ( $V_d = 5V$ ,  $I_{ds} = 5mA$ )**

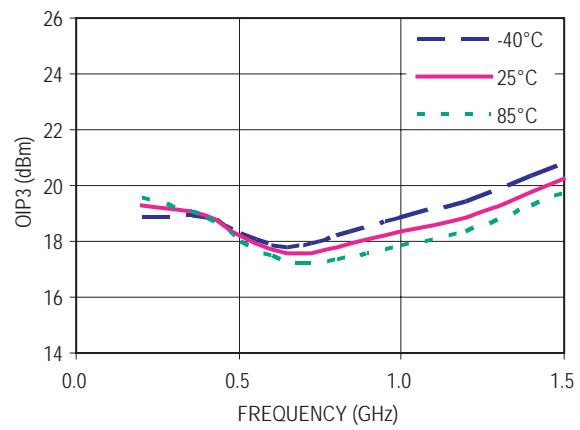


**Figure 32. Output Return Loss vs Frequency ( $V_d = 5V$ ,  $I_{ds} = 5mA$ )**

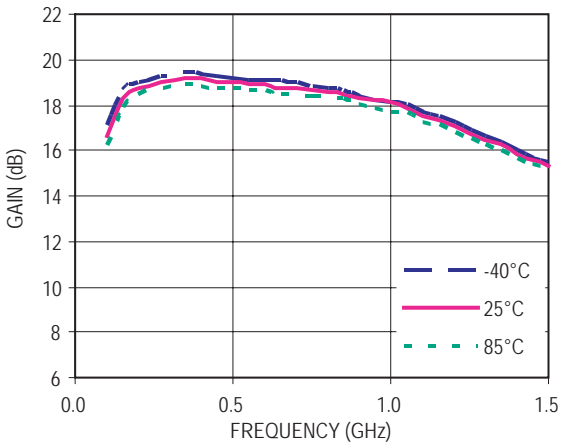
**MGA-685T6 Typical Performance,  $V_d = 5V$ ,  $I_{ds} = 10mA$ ,  $R_1 = 10K\Omega$  as measured in Fig 1a test circuit (unless specified otherwise)**



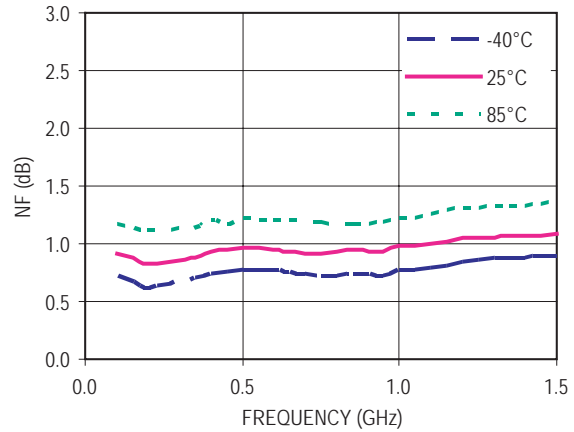
**Figure 33. OP1dB vs Frequency ( $V_d = 5V$ ,  $I_{ds} = 10mA$ )**



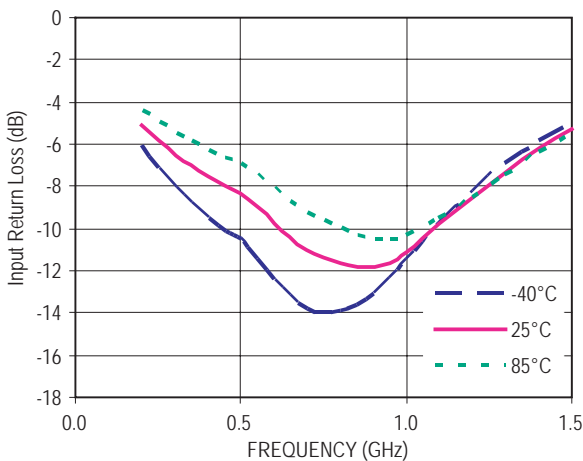
**Figure 34. OIP3 vs Frequency ( $V_d = 5V$ ,  $I_{ds} = 10mA$ )**



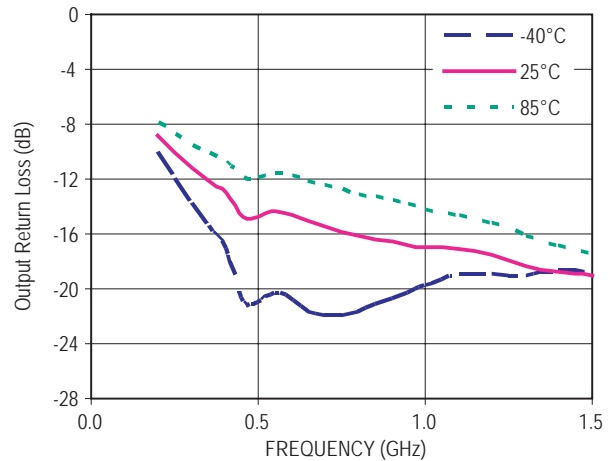
**Figure 35. Gain vs Frequency ( $V_d = 5V$ ,  $I_{ds} = 10mA$ )**



**Figure 36. NF vs Frequency ( $V_d = 5V$ ,  $I_{ds} = 10mA$ )**

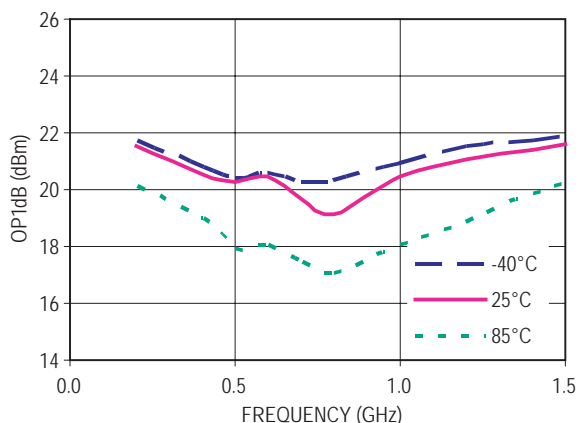


**Figure 37. Input Return Loss vs Frequency ( $V_d = 5V$ ,  $I_{ds} = 10mA$ )**

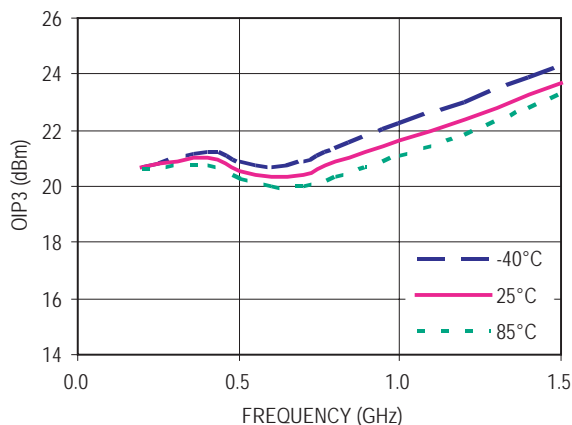


**Figure 38. Output Return Loss vs Frequency ( $V_d = 5V$ ,  $I_{ds} = 10mA$ )**

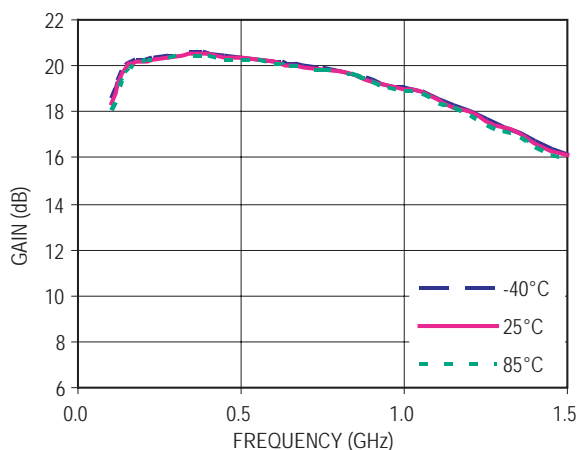
**MGA-685T6 Typical Performance,  $V_d = 5V$ ,  $I_{ds} = 15mA$ ,  $R_1 = 5.6K\Omega$  as measured in Fig 1a test circuit (unless specified otherwise)**



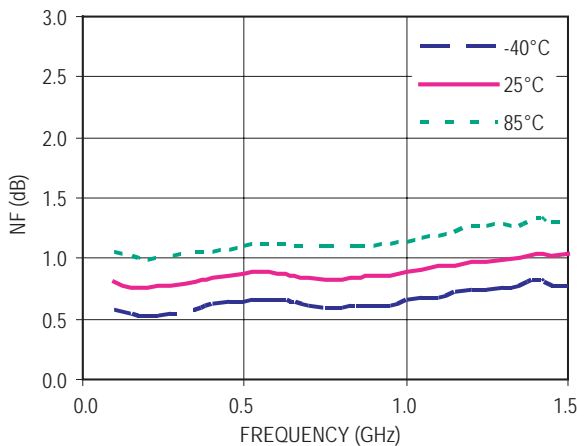
**Figure 39. OP1dB vs Frequency ( $V_d = 5V$ ,  $I_{ds} = 15mA$ )**



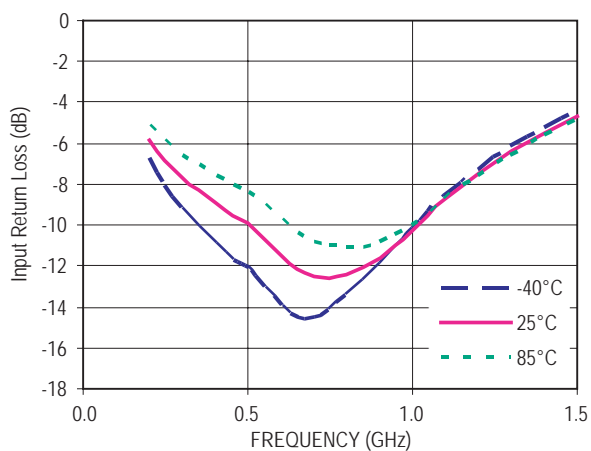
**Figure 40. OIP3 vs Frequency ( $V_d = 5V$ ,  $I_{ds} = 15mA$ )**



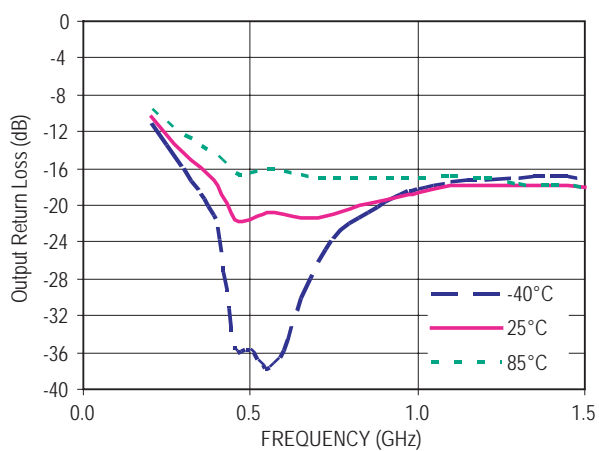
**Figure 41. Gain vs Frequency ( $V_d = 5V$ ,  $I_{ds} = 15mA$ )**



**Figure 42. NF vs Frequency ( $V_d = 5V$ ,  $I_{ds} = 15mA$ )**



**Figure 43. Input Return Loss vs Frequency ( $V_d = 5V$ ,  $I_{ds} = 15mA$ )**

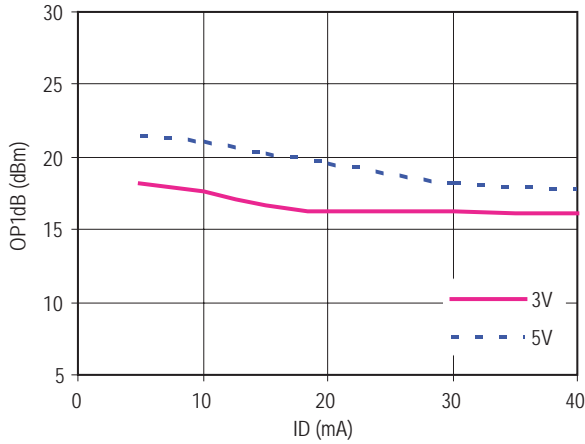


**Figure 44. Output Return Loss vs Frequency ( $V_d = 5V$ ,  $I_{ds} = 15mA$ )**

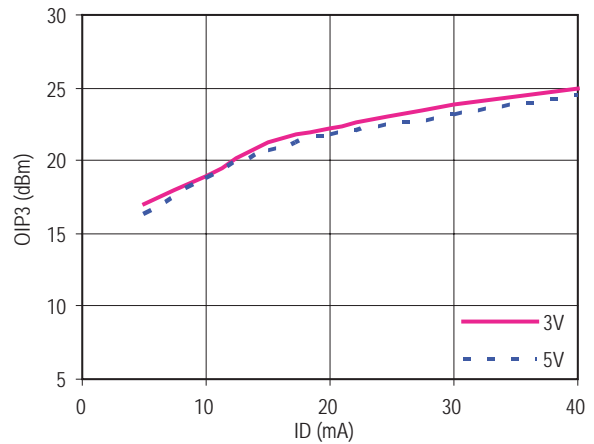
Notes for Figure 6 ~ 44:

1. Measurement uses the test circuit and circuit schematics shows in Figure 1a.
2.  $I_{ds}$  taken at ambient temperature of 25°C with temperature variation.
3. Bias current ( $I_{ds}$ ) for the above charts are quiescent conditions. Actual level may increase or decrease depending on amount of RF drive.

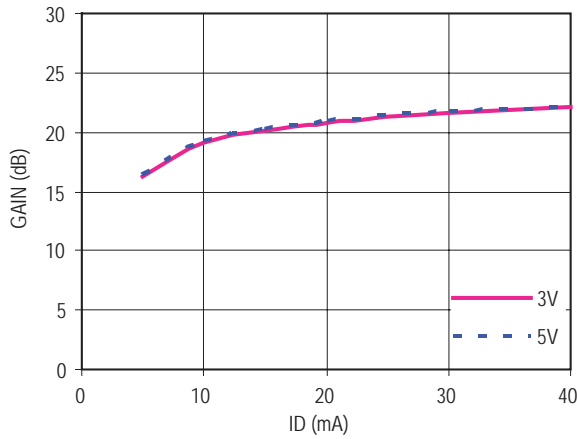
**MGA-685T6 Typical Performance, Freq = 0.5 GHz, Tc = 25°C**



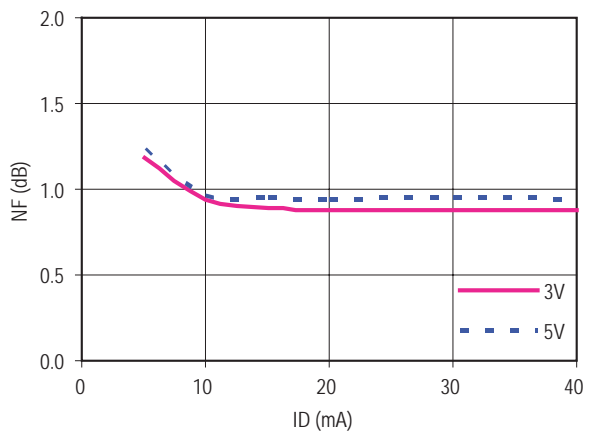
**Figure 45. OP1dB vs Id ( 500 MHz )**



**Figure 46. OIP3 vs Id ( 500 MHz )**



**Figure 47. Gain vs Id (500 MHz)**

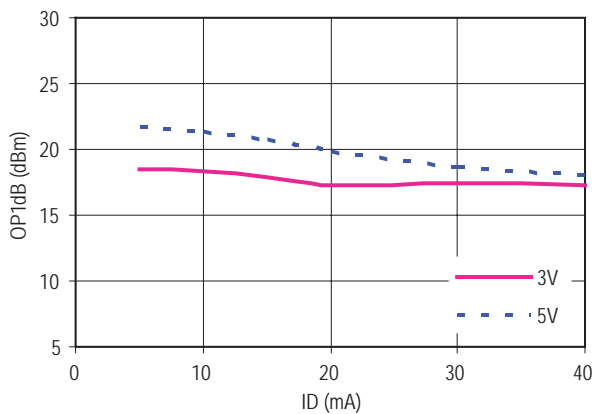


**Figure 48. NF vs Id ( 500 MHz )**

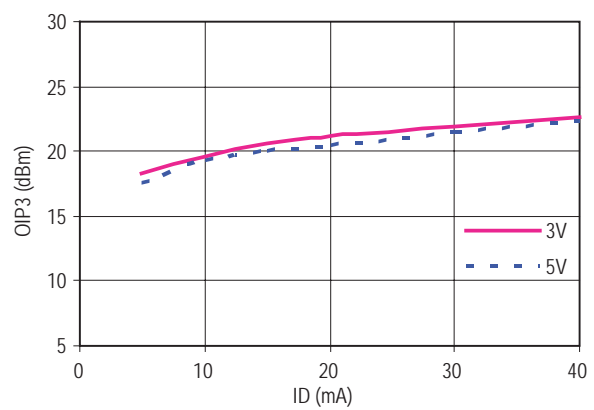
**Notes:**

1. Measurement uses the test circuit and circuit schematics shows in Figure 1a.
2. Bias current (Id) for the above charts are quiescent conditions. Actual level may increase or decrease depending on amount of RF drive.

**MGA-685T6 Typical Performance, Freq = 0.1 GHz, Tc = 25°C**



**Figure 49. OP1dB vs Id ( 100 MHz )**



**Figure 50. OIP3 vs Id ( 100 MHz )**

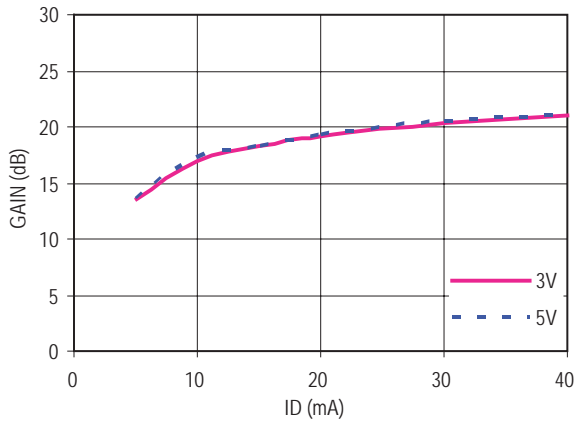


Figure 51. Gain vs Id (100 MHz)

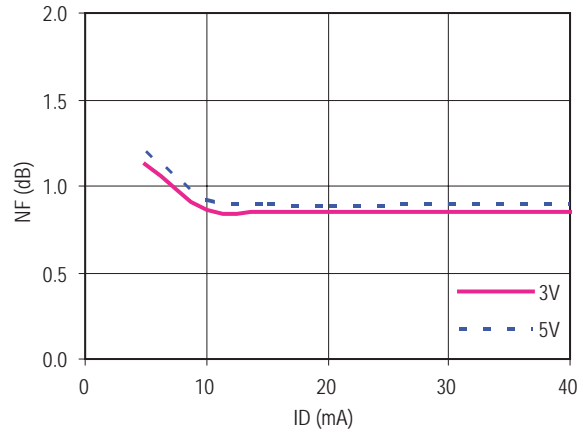


Figure 52. NF vs Id (100 MHz)

Notes:

1. Measurement uses the test circuit and circuit schematics shows in Figure 1a.
2. Bias current ( $I_{ds}$ ) for the above charts are quiescent conditions. Actual level may increase or decrease depending on amount of RF drive.

### MGA-685T6 Typical Performance, Freq = 0.5 GHz, $I_{ds} = 10\text{mA}$ , $T_c = 25^\circ\text{C}$

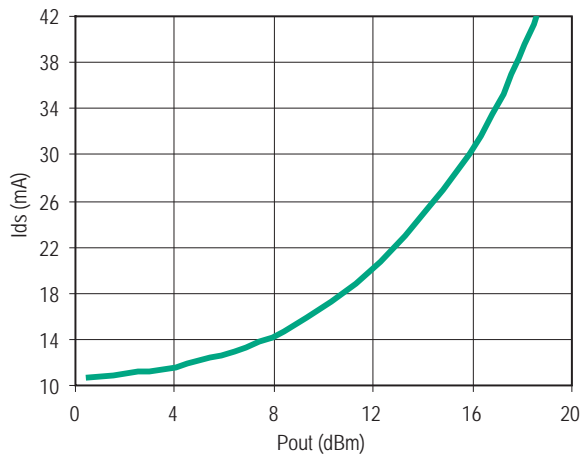


Figure 53.  $I_{ds}$  vs Pout ( $V_d = 3\text{V}$ )

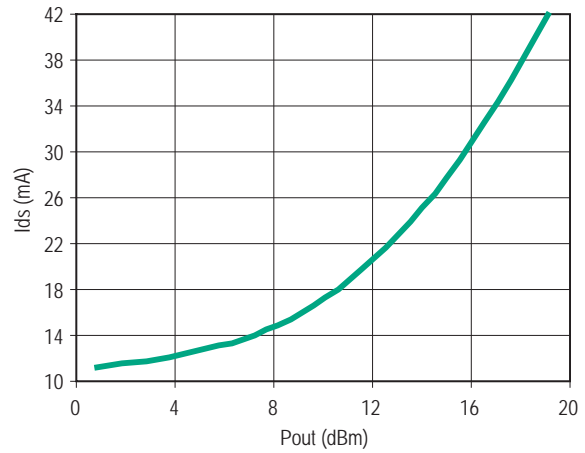


Figure 54.  $I_{ds}$  vs Pout ( $V_d = 5\text{V}$ )

Notes:

1. Measurement uses the test circuit and circuit schematics shows in Figure 1a.
2. Bias current ( $I_{ds} = 10\text{mA}$ ) for the above charts are quiescent conditions.

## MGA-685T6 Typical Scattering Parameters and Noise Parameters

Tc = 25°C, Zo = 50ohm, Vd = 3V, Ids = 5mA (Test circuit of Figure 1b)

Freq GHz	S11		S21			S12		S22	
	Mag	Ang	dB	Mag	Ang	Mag	Ang	Mag	Ang
0.1	0.53	-15.30	16.77	6.89	170.80	0.07	10.20	0.44	-14.80
0.2	0.53	-21.80	16.64	6.79	166.30	0.07	9.30	0.43	-19.40
0.3	0.52	-28.40	16.52	6.70	161.80	0.07	8.50	0.42	-24.10
0.4	0.52	-34.90	16.38	6.60	157.30	0.08	7.60	0.41	-28.70
0.5	0.52	-41.40	16.25	6.50	152.80	0.08	6.70	0.40	-33.30
0.6	0.52	-48.30	16.04	6.34	148.30	0.08	6.70	0.39	-38.20
0.7	0.52	-55.10	15.83	6.19	143.80	0.08	6.60	0.38	-43.10
0.8	0.53	-61.90	15.61	6.03	139.20	0.08	6.60	0.37	-48.00
0.9	0.53	-68.80	15.38	5.88	134.70	0.08	6.50	0.36	-52.90
1.0	0.54	-74.70	15.13	5.71	130.60	0.08	6.20	0.35	-57.40
1.5	0.57	-99.20	13.75	4.87	111.90	0.09	4.50	0.31	-76.70
1.9	0.59	-115.90	12.60	4.27	99.40	0.10	1.70	0.28	-88.10
2.0	0.59	-117.90	12.09	4.02	97.70	0.10	1.20	0.27	-92.00
2.5	0.61	-138.10	10.83	3.48	84.20	0.10	-2.20	0.25	-103.40
3.0	0.62	-152.90	9.72	3.06	71.90	0.11	-6.60	0.23	-108.20
3.5	0.63	-167.60	8.68	2.72	60.30	0.11	-12.00	0.22	-120.20
4.0	0.63	178.10	7.88	2.48	49.00	0.11	-18.20	0.18	-140.50
4.5	0.64	163.90	6.73	2.17	38.90	0.11	-26.30	0.15	-158.30
5.0	0.65	157.00	6.46	2.10	29.10	0.11	-30.20	0.13	-178.40
5.5	0.66	144.50	5.49	1.88	19.20	0.11	-34.00	0.16	168.10
6.0	0.67	130.40	4.59	1.70	10.70	0.11	-37.90	0.18	155.50
7.0	0.71	116.90	3.72	1.54	-8.10	0.10	-47.20	0.25	130.20
8.0	0.75	100.40	2.29	1.30	-26.00	0.10	-54.00	0.32	116.10
9.0	0.78	87.20	0.94	1.11	-43.80	0.09	-59.30	0.37	105.00
10.0	0.80	76.30	-0.62	0.93	-60.70	0.09	-63.60	0.42	94.50

Freq GHz	Fmin dB	Γopt		Rn / 50
		Mag	Ang	
0.1	0.93	0.09	52.40	0.12
0.5	0.98	0.12	75.80	0.12
1.0	0.99	0.17	79.40	0.12
1.5	1.01	0.22	86.90	0.12
2.0	1.03	0.26	95.70	0.12
2.5	1.06	0.31	109.75	0.12
3.0	1.05	0.34	118.10	0.11
3.5	1.12	0.35	118.50	0.10
4.0	1.15	0.37	138.90	0.09
4.5	1.17	0.38	159.30	0.08
5.0	1.23	0.41	171.90	0.07
5.5	1.28	0.41	-177.60	0.07
6.0	1.34	0.42	-166.70	0.07

Note:

- Fmin values at 2 GHz and higher are based on measurements while the Fmin below 2 GHz have been extrapolated. The Fmin values are based on a set of 16 noise figure measurements made at 16 different impedances using an ATN NP5 test system. From these measurements a true Fmin is calculated.

## MGA-685T6 Typical Scattering Parameters and Noise Parameters

Tc = 25°C, Zo = 50ohm, Vd = 3V, Ids = 10mA (Test circuit of Figure 1b)

Freq GHz	S11		S21			S12		S22	
	Mag	Ang	dB	Mag	Ang	Mag	Ang	Mag	Ang
0.1	0.40	-22.10	19.51	9.46	169.70	0.06	9.00	0.28	-22.80
0.2	0.40	-30.30	19.35	9.28	165.00	0.06	8.10	0.27	-28.00
0.3	0.41	-38.50	19.18	9.10	160.20	0.06	7.10	0.26	-33.30
0.4	0.41	-46.60	19.02	8.93	155.50	0.06	6.20	0.25	-38.50
0.5	0.41	-54.80	18.84	8.75	150.70	0.06	5.20	0.24	-43.70
0.6	0.42	-62.60	18.59	8.50	145.90	0.07	5.20	0.24	-49.80
0.7	0.43	-70.40	18.32	8.24	141.20	0.07	5.20	0.24	-55.80
0.8	0.45	-78.20	18.04	7.98	136.40	0.07	5.10	0.23	-61.90
0.9	0.46	-86.00	17.76	7.73	131.60	0.07	5.10	0.23	-67.90
1.0	0.47	-92.30	17.45	7.46	127.30	0.07	4.80	0.23	-73.20
1.5	0.53	-116.70	15.82	6.18	108.40	0.07	3.80	0.21	-96.00
1.9	0.56	-132.10	14.51	5.32	96.10	0.08	1.80	0.20	-107.60
2.0	0.57	-136.10	14.11	5.07	93.80	0.08	1.40	0.19	-109.40
2.5	0.59	-149.40	12.27	4.11	81.40	0.09	-1.30	0.18	-128.20
3.0	0.61	-166.70	11.15	3.61	69.30	0.09	-4.30	0.16	-147.20
3.5	0.63	-179.70	10.26	3.26	58.00	0.09	-7.50	0.15	-166.90
4.0	0.64	167.30	9.33	2.93	47.70	0.09	-11.30	0.14	-178.00
4.5	0.65	153.50	8.24	2.58	38.20	0.09	-17.10	0.13	171.20
5.0	0.66	150.00	7.49	2.37	28.90	0.10	-20.10	0.14	160.80
5.5	0.67	137.20	6.69	2.16	19.70	0.10	-24.50	0.16	151.30
6.0	0.69	122.80	5.99	1.99	11.10	0.10	-27.00	0.19	140.10
7.0	0.71	111.90	4.77	1.73	-6.40	0.10	-33.40	0.27	121.50
8.0	0.75	95.90	3.43	1.49	-23.40	0.09	-41.40	0.33	109.60
9.0	0.78	83.50	2.07	1.27	-40.20	0.09	-47.40	0.38	99.10
10.0	0.81	73.20	0.53	1.06	-56.60	0.09	-53.20	0.42	91.50

Freq GHz	Fmin dB	Γopt		Rn / 50
		Mag	Ang	
0.1	0.77	0.03	71.80	0.08
0.5	0.82	0.06	95.20	0.08
1.0	0.83	0.11	98.80	0.08
1.5	0.85	0.16	106.30	0.08
2.0	0.87	0.20	115.10	0.08
2.5	0.90	0.26	126.25	0.08
3.0	0.90	0.28	135.80	0.08
3.5	0.95	0.30	142.00	0.08
4.0	1.00	0.32	156.20	0.08
4.5	1.04	0.33	170.40	0.07
5.0	1.08	0.35	-176.50	0.06
5.5	1.13	0.35	-166.00	0.06
6.0	1.19	0.36	-155.10	0.06

Note :

- Fmin values at 2 GHz and higher are based on measurements while the Fmin below 2 GHz have been extrapolated. The Fmin values are based on a set of 16 noise figure measurements made at 16 different impedances using an ATN NP5 test system. From these measurements a true Fmin is calculated.

## MGA-685T6 Typical Scattering Parameters and Noise Parameters

Tc = 25°C, Zo = 50ohm, Vd = 3V, Ids = 15mA (Test circuit of Figure 1b)

Freq GHz	S11		S21			S12		S22	
	Mag	Ang	dB	Mag	Ang	Mag	Ang	Mag	Ang
0.1	0.36	-29.20	20.92	11.11	169.10	0.06	9.00	0.20	-38.20
0.2	0.37	-38.30	20.73	10.88	164.20	0.06	7.80	0.18	-40.90
0.3	0.37	-47.30	20.54	10.65	159.40	0.06	6.70	0.17	-43.50
0.4	0.38	-56.40	20.35	10.41	154.50	0.06	5.50	0.16	-46.20
0.5	0.38	-65.40	20.15	10.18	149.60	0.06	4.30	0.14	-48.80
0.6	0.40	-73.60	19.87	9.86	144.70	0.06	4.20	0.13	-54.90
0.7	0.41	-81.70	19.58	9.53	139.80	0.06	4.00	0.12	-60.90
0.8	0.43	-89.90	19.29	9.21	134.90	0.06	3.90	0.12	-67.00
0.9	0.44	-98.00	18.98	8.89	130.00	0.06	3.70	0.11	-73.00
1.0	0.46	-104.60	18.64	8.55	125.70	0.06	3.50	0.10	-78.80
1.5	0.52	-130.40	16.91	7.00	106.70	0.07	3.10	0.07	-106.90
1.9	0.55	-145.70	15.58	6.01	94.30	0.07	2.90	0.06	-128.80
2.0	0.56	-149.00	15.26	5.80	91.50	0.07	2.80	0.06	-134.20
2.5	0.59	-163.50	13.78	4.89	78.60	0.07	1.90	0.08	-158.80
3.0	0.61	-175.60	12.46	4.20	67.10	0.08	0.20	0.10	-178.60
3.5	0.62	173.80	11.29	3.67	56.70	0.08	-2.30	0.12	166.30
4.0	0.64	164.20	10.24	3.25	47.00	0.08	-5.30	0.14	154.60
4.5	0.65	155.20	9.29	2.91	37.70	0.09	-8.70	0.16	145.20
5.0	0.67	146.10	8.42	2.64	28.70	0.09	-12.30	0.17	137.40
5.5	0.68	138.20	7.61	2.40	20.00	0.09	-16.10	0.20	130.60
6.0	0.70	130.20	6.86	2.20	11.40	0.09	-19.90	0.23	124.60
7.0	0.73	113.70	5.46	1.88	-5.50	0.09	-27.50	0.29	113.90
8.0	0.77	97.30	4.12	1.61	-22.10	0.09	-34.80	0.35	104.40
9.0	0.80	80.80	2.75	1.37	-38.50	0.09	-41.60	0.40	95.70
10.0	0.82	64.60	1.27	1.16	-54.40	0.09	-47.80	0.44	87.40

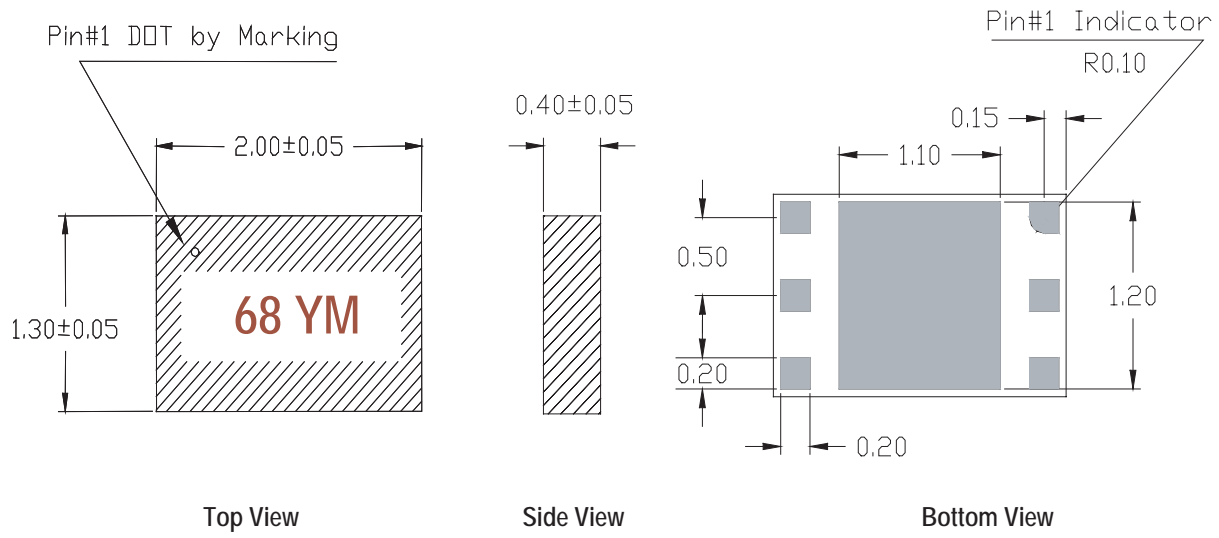
Freq GHz	Fmin dB	Γopt		Rn / 50
		Mag	Ang	
0.1	0.70	0.02	85.70	0.07
0.5	0.75	0.05	109.10	0.07
1.0	0.76	0.10	112.70	0.07
1.5	0.78	0.15	120.20	0.07
2.0	0.80	0.19	129.00	0.07
2.5	0.83	0.23	138.40	0.07
3.0	0.85	0.26	148.00	0.07
3.5	0.89	0.29	157.80	0.07
4.0	0.92	0.31	167.80	0.06
4.5	0.96	0.32	177.90	0.06
5.0	1.00	0.34	-171.70	0.06
5.5	1.05	0.34	-161.20	0.06
6.0	1.11	0.35	-150.30	0.06

Note:

1. Fmin values at 2 GHz and higher are based on measurements while the Fmin below 2 GHz have been extrapolated. The Fmin values are based on a set of 16 noise figure measurements made at 16 different impedances using an ATN NP5 test system. From these measurements a true Fmin is calculated.



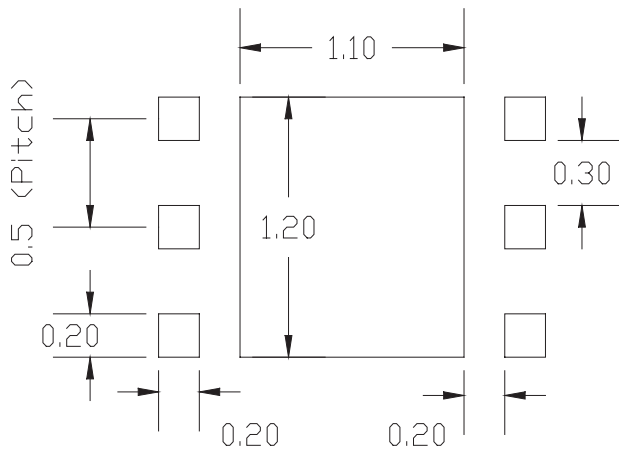
## Package Dimensions



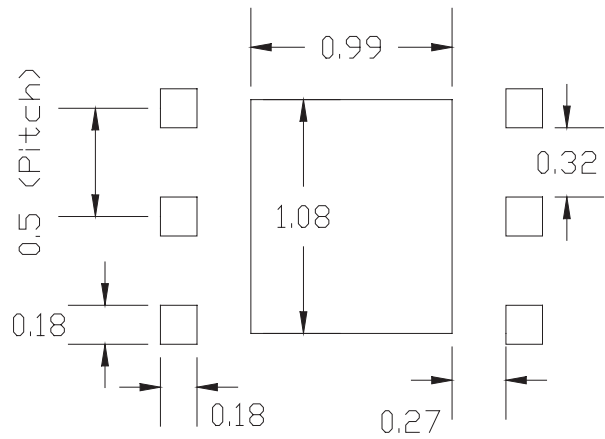
## Part Number Ordering Information

Part Number	No. of Devices	Container
MGA-685T6-BLKG	100	Antistatic bag
MGA-685T6-TR1G	3,000	7" Reel
MGA-685T6-TR2G	10,000	13" Reel

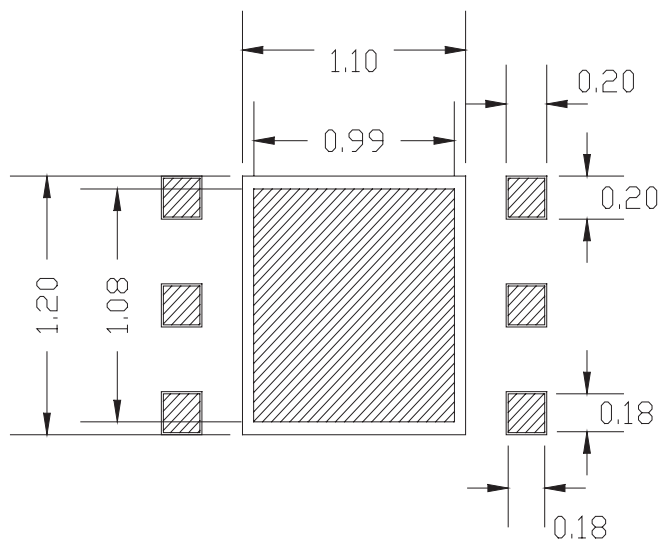
## PCB Land Patterns and Stencil Design



PCB Land Pattern (dimensions in mm)

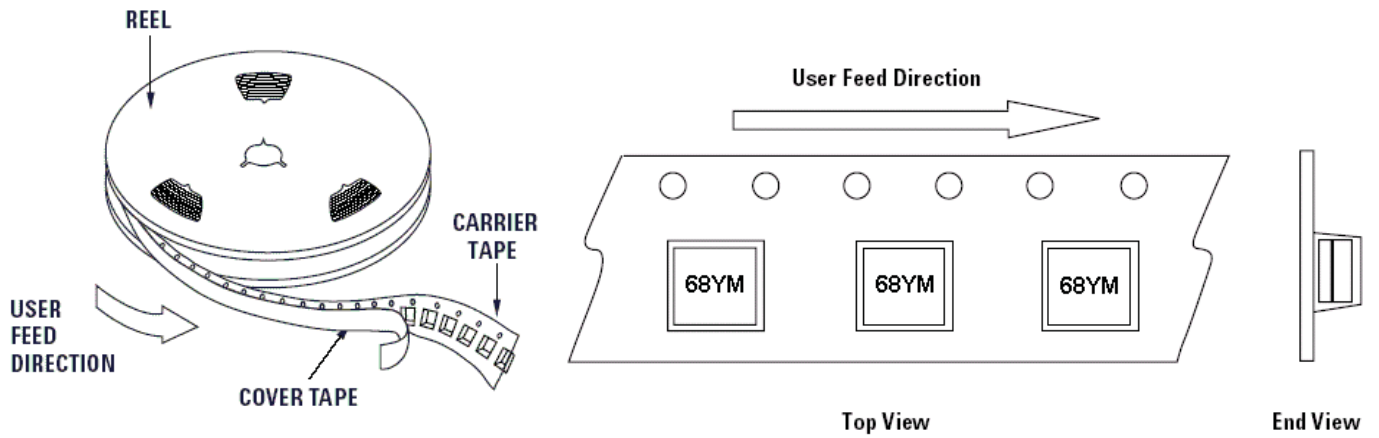


Stencil Outline Drawing (dimensions in mm)

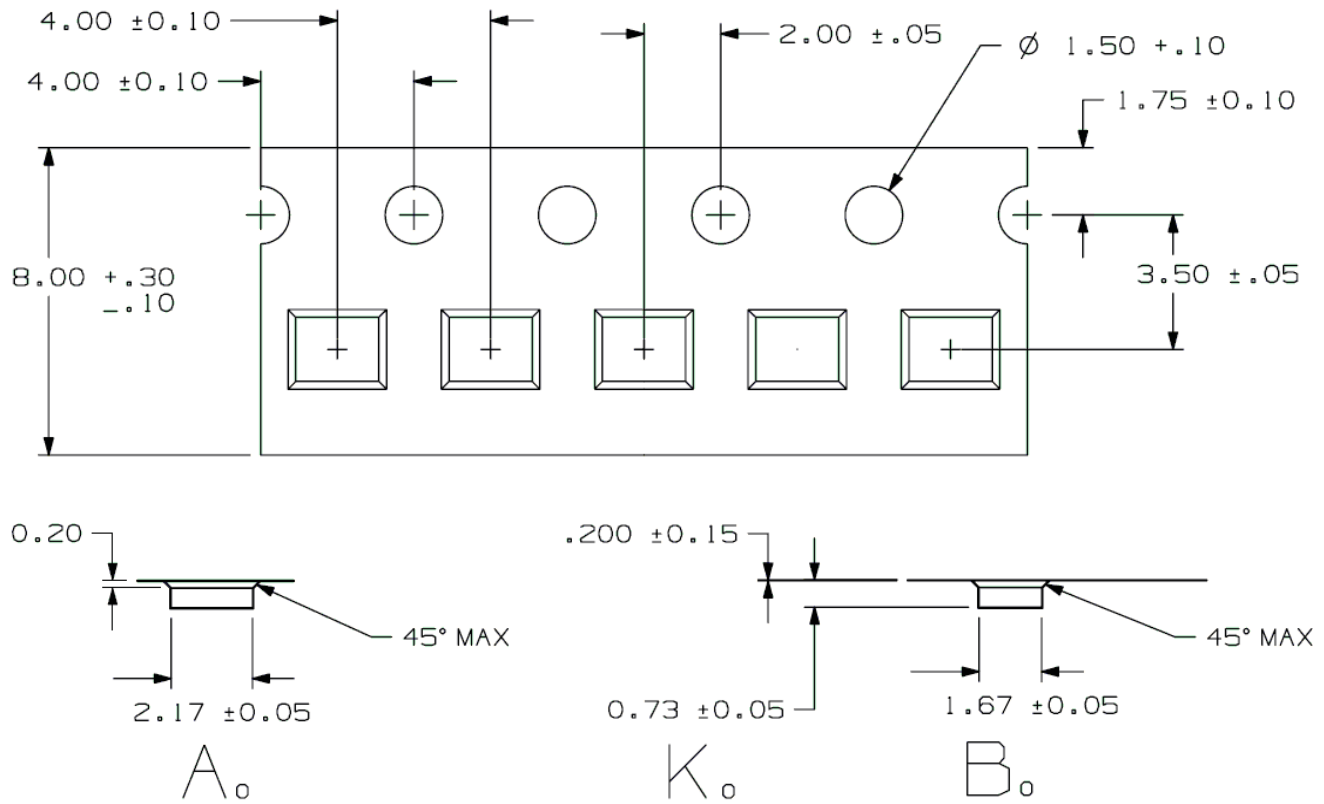


Combined PCB and Stencil Layouts (dimensions in mm)

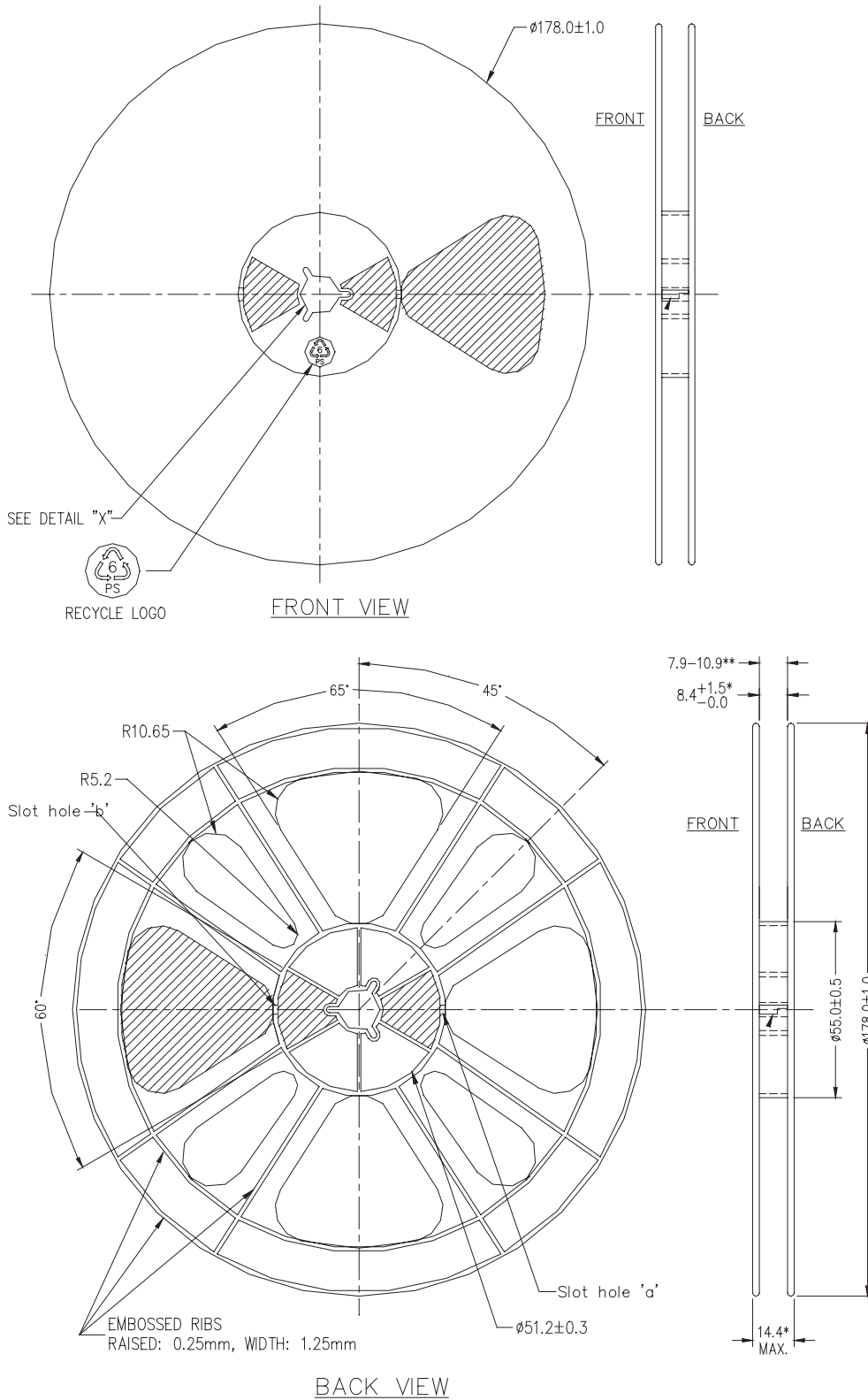
### Device Orientation



### Tape Dimensions



# Reel Dimensions



For product information and a complete list of distributors, please go to our web site: [www.avagotech.com](http://www.avagotech.com)

Avago, Avago Technologies, and the A logo are trademarks of Avago Technologies Limited in the United States and other countries. Data subject to change. Copyright © 2005-2008 Avago Technologies Limited. All rights reserved. AV02-0057EN - May 27, 2008

