

LM6021A

LCD Module User Manual

Shenzhen TOPWAY Technology Co., Ltd.

Rev.	Descriptions	Release Date
0.1	Preliminary release	2003-06-25
0.2	Typing Correction Section 4.5.1 - Power Control Command, 20h → 2Fh Section 3.2 - Applicable Pin, ABL → A	2004-03-26
0.3	Product Update Section 1.2 – Mechanical Specification, 15.3MAX → 12.1MAX Section 4.5.1 – Init sequence, Electronic Control Register=90h → Electronic Control Register=8Dh	2006-12-15
0.4	Section 3.2 – LED Backlight Circuit Characteristics, 3.7V → 3.3V	2007-02-07
0.5	Typing Correction on BIAS setting	2007-11-07

Table of Content

1. Basic Specifications	3
1.1 Display Specifications	3
1.2 Mechanical Specifications	3
1.3 Block Diagram	3
1.4 Terminal Functions	4
2. Absolute Maximum Ratings	5
3. Electrical Characteristics	5
3.1 DC Characteristics	5
3.2 LED Backlight Circuit Characteristics	5
3.3 AC Characteristics	6
4. Function Specifications	9
4.1 Basic Setting	9
4.2 Resetting the LCD module	9
4.3 Display Memory Map	9
4.4 Display Commands	10
4.5 Basic Operating Sequence (example)	11
5. Design and Handling Precaution	13

1. Basic Specifications

1.1 Display Specifications

- 1) LCD Display Mode : STN, Positive, Transflective
- 2) Display Color : Display Data = "1" : Deep Blue (*1)
: Display Data = "0" : Light Gray (*2)
- 3) Viewing Angle : 6H
- 4) Driving Method : 1/65 duty, 1/8 bias
- 5) Back Light : White LED backlight

Note:

- *1. Color tone may slightly change by Temperature and Driving Condition.
- *2. The Color is defined as the inactive / background color

1.2 Mechanical Specifications

- 1) Outline Dimension : 93.0 x 70.0 x 15.3MAX
(See attached Outline Drawing for details)

1.3 Block Diagram

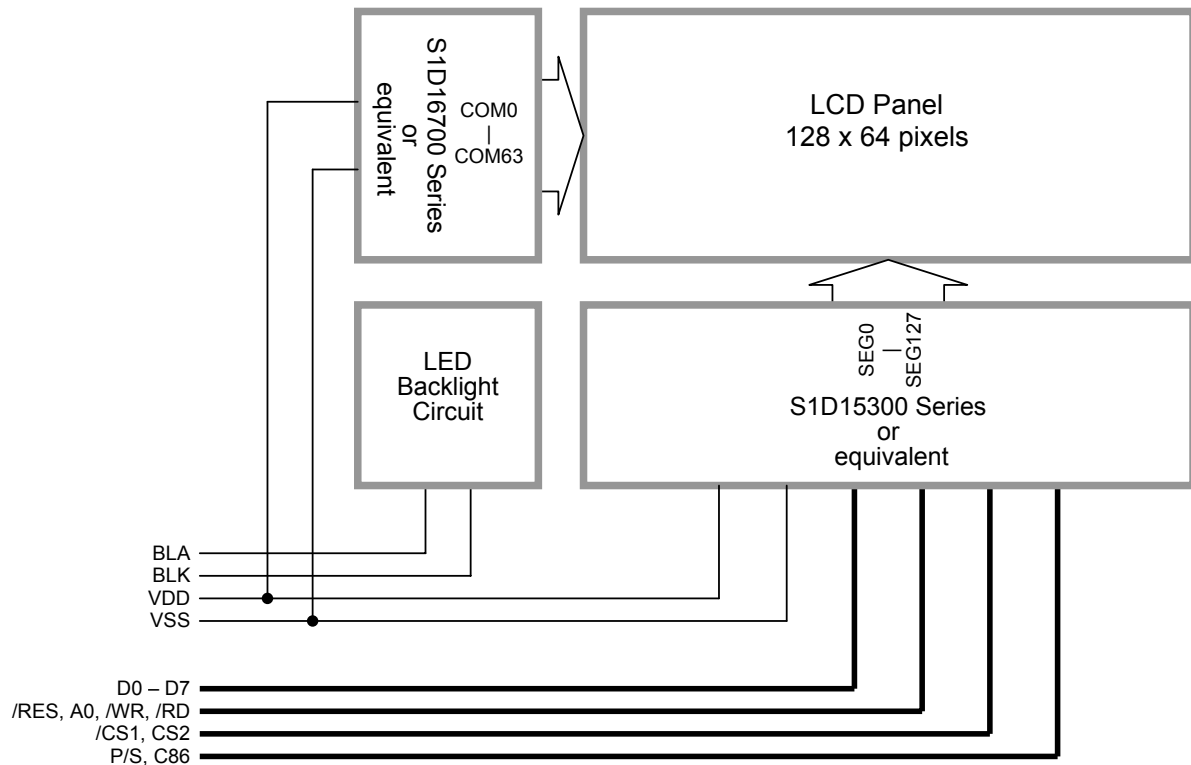

1.4 Terminal Functions

Pin No.	Pin Name	I/O	Descriptions																		
1	VSS	Supply	0V Supply, Ground (0V)																		
2	VDD	Supply	Positive Power Supply																		
3	/RES	Input	Reset signal pin /RES=LOW: Initialization is executed /RES=HIGH: Normal																		
4	P/S	Input	Serial / Parallel interface select pin. P/S=HIGH: Parallel interface selected P/S=LOW: Serial interface selected <table border="1" style="margin-left: 20px;"> <thead> <tr> <th>P/S</th> <th>Chip Select</th> <th>Data / Command</th> <th>Data</th> <th>Read / Write</th> <th>Serial Clock</th> </tr> </thead> <tbody> <tr> <td>HIGH</td> <td>/CS1, CS2</td> <td>A0</td> <td>D0-D7</td> <td>/RD, /WR</td> <td>-</td> </tr> <tr> <td>LOW</td> <td>/CS1, CS2</td> <td>A0</td> <td>SI (D7)</td> <td>Write only</td> <td>SCL (D6)</td> </tr> </tbody> </table> <p>In serial interface mode:</p> <ul style="list-style-type: none"> - no data can be read from RAM - D0 to D5 are HZ - /RD and /WR must be fixed HIGH or LOW 	P/S	Chip Select	Data / Command	Data	Read / Write	Serial Clock	HIGH	/CS1, CS2	A0	D0-D7	/RD, /WR	-	LOW	/CS1, CS2	A0	SI (D7)	Write only	SCL (D6)
P/S	Chip Select	Data / Command	Data	Read / Write	Serial Clock																
HIGH	/CS1, CS2	A0	D0-D7	/RD, /WR	-																
LOW	/CS1, CS2	A0	SI (D7)	Write only	SCL (D6)																
5 6	/CS1 CS2	Input	Chip Select inputs /CS1=LOW, CS2=HIGH: Data IO is enabled /CS1=HIGH, CS2=LOW: Data IO is disabled, D0 - D7 will be "HZ"																		
7	C86	Input	Microprocessor interface select pin. C86=HIGH: 6800 series microprocessor interface C86=LOW: 8080 series microprocessor interface																		
8	A0	Input	Control / Display data flag input. A0=HIGH: data on D0 to D7 is display data A0=LOW: data on D0 to D7 is control data																		
9	/WR(R/W)	Input	In 8080 interface mode: Write enable input, active LOW In 6800 interface mode: R/W=HIGH: Read mode selected R/W=LOW: Write mode selected																		
10	/RD(E)	Input	In 8080 interface mode: Read enable input, active LOW In 6800 interface mode: Enable Clock Signal, active HIGH																		
11-18	D0 -D7 (SI),(SCL)	I/O	8-bit bi-directional data bus In parallel interface mode: 8-bit data I/O In serial interface mode: D7=SI(Serial data input), D6=SCL(Serial clock input)																		
19	BLA	Supply	Backlight positive Supply																		
20	BLK	Supply	Backlight negative Supply																		

2. Absolute Maximum Ratings

Items	Symbol	Min.	Max.	Unit	Condition
Supply Voltage	V_{DD}	0	4.0	V	$V_{SS} = 0V$
Input Voltage	V_{IN}	0	V_{DD}	V	$V_{SS} = 0V$
Operating Temperature	T_{OP}	-20	70	°C	No Condensation
Storage Temperature	T_{ST}	-20	80	°C	No Condensation

Cautions:

Any Stresses exceeding the Absolute Maximum Ratings may cause substantial damage to the device. Functional operation of this device at other conditions beyond those listed in the specification is not implied and prolonged exposure to extreme conditions may affect device reliability.

3. Electrical Characteristics

3.1 DC Characteristics

$V_{SS}=0V, V_{DD}=3.0V, T_{OP}=25^{\circ}C$

Items	Symbol	MIN.	TYP.	MAX.	Unit	Condition / Application Pin
Operating Voltage	V_{DD}	2.8	3.0	3.2	V	VDD
Input High Voltage	V_{IH}	$0.9 \times V_{DD}$	-	V_{DD}	V	/RES,P/S,/CS1,CS2,C86,
Input Low Voltage	V_{IL}	0	-	$0.1 \times V_{DD}$	V	A0,/WR,/RD,D0~D7
Output High Voltage	V_{OH}	$0.7 \times V_{DD}$	-	V_{DD}	V	$I_{OH}=-0.3mA, D0~D7$
Output Low Voltage	V_{OL}	0	-	$0.3 \times V_{DD}$	V	$I_{OL}=0.3mA, D0~D7$
Operating Current	I_{DD}	-	0.4	1.5	mA	VDD, VSS
Sleep Mode Current	I_{DSS}	-	-	2	μA	VDD, VSS

3.2 LED Backlight Circuit Characteristics

$V_{BLK}=0V, I_{f_{BLA}}=80mA, T_{OP}=25^{\circ}C$

Items	Symbol	MIN.	TYP.	MAX.	Unit	Applicable Pin
Forward Voltage	$V_{f_{BLA}}$	-	3.3	-	V	BLA
Forward Current	$I_{f_{BLA}}$	-	-	120	mA	BLA

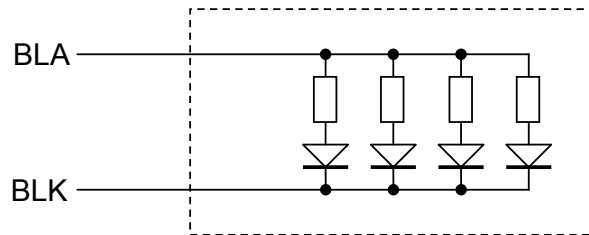

3.3 AC Characteristics

3.3.1 8080 Mode System Bus Timing

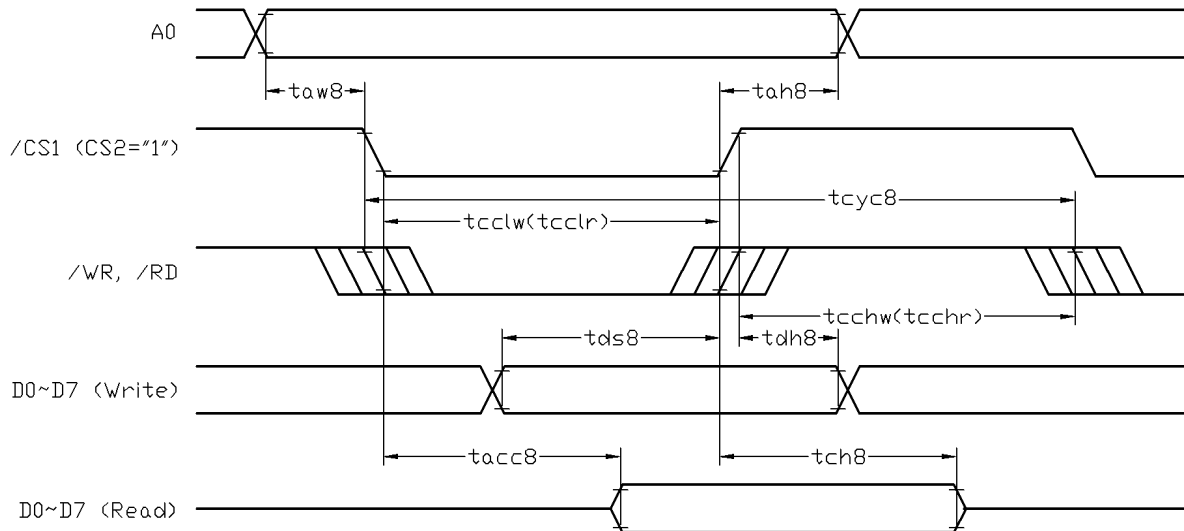

$V_{SS}=0V, V_{DD}=3V, T_{OP}=25^{\circ}C$

Item	Symbol	MIN.	TYP.	MAX.	Unit
Address hold time (A0)	tah8	38	-	-	ns
Address setup time (A0)	taw8	30	-	-	ns
System cycle time	tcyc8	900	-	-	ns
Control LOW pulse width (/WR)	tcclw	120	-	-	ns
Control LOW pulse width (/RD)	tcclr	280	-	-	ns
Control HIGH pulse width (/WR)	tcchw	400	-	-	ns
Control HIGH pulse width (/RD)	tcchr	280	-	-	ns
Data setup time	tds8	80	-	-	ns
Data hold time	tdh8	30	-	-	ns
/RD access time (*2)	tacc8	-	-	280	ns
Output disable time (*2)	tch8	-	-	200	ns

Note:

*1. Input signal rise/fall time should be less than 12ns

*2. CL=100pF

3.3.2 6800 Mode System Bus Timing

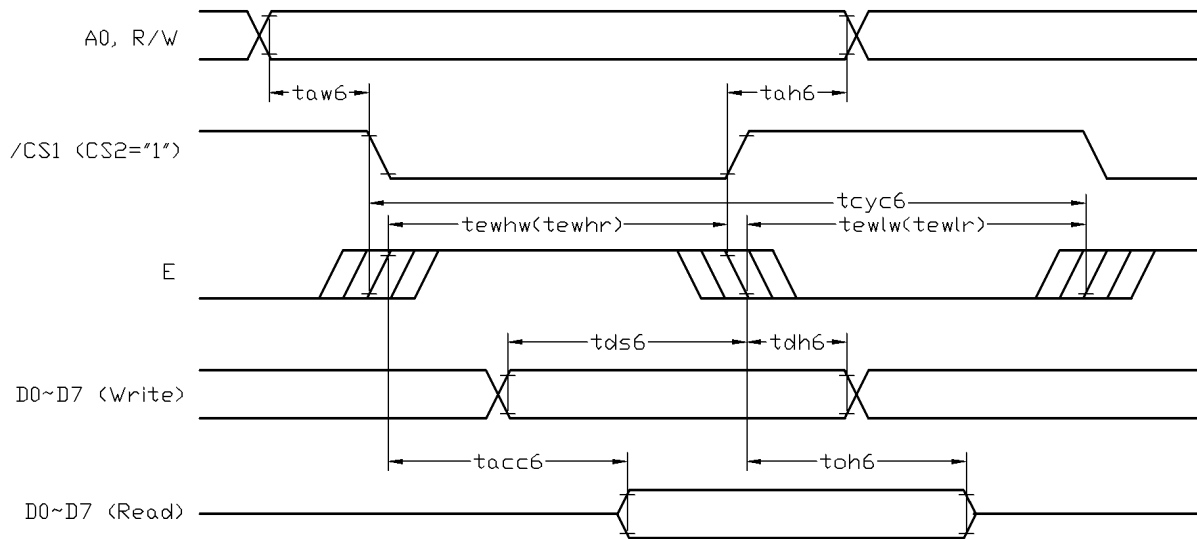

$V_{SS}=0V, V_{DD}=3V, T_{OP}=25^{\circ}C$

Item	Symbol	MIN.	TYP.	MAX.	Unit
System cycle time	tcyc6	900	-	-	ns
Address setup time	taw6	30	-	-	ns
Address hold time	tah6	38	-	-	ns
Data setup time	tds6	80	-	-	ns
Data hold time	tdh6	30	-	-	ns
Output disable time (*2)	toh6	-	-	200	ns
Access time (*2)	tacc6	-	-	280	ns
Enable High pulse width (Read)	tewhr	280	-	-	ns
Enable High pulse width (Write)	tewhw	120	-	-	ns
Enable Low pulse width (Read)	tewlr	280	-	-	ns
Enable Low pulse width (Write)	tewlw	400	-	-	ns

Note:

*1. Input signal rise/fall time should be less than 12ns

*2. CL=100pF

3.3.3 Serial Interface Timing

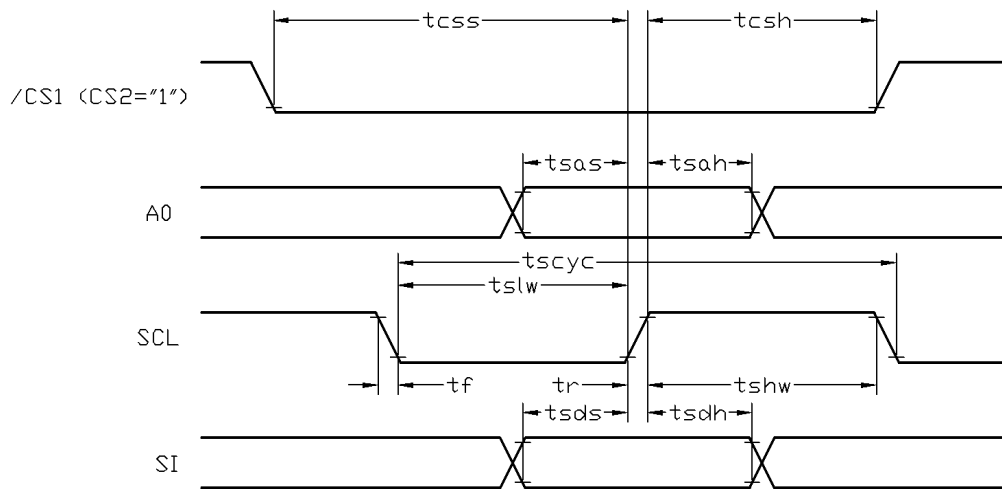

$V_{SS}=0V, V_{DD}=3V, T_{OP}=25^{\circ}C$

Item	Symbol	MIN.	TYP.	MAX.	Unit
Serial clock cycle	tscyc	1000	-	-	ns
Serial clock High pulse width	tshw	400	-	-	ns
Serial clock Low pulse width	tslw	300	-	-	ns
Address setup time	tsas	200	-	-	ns
Address hold time	tsah	800	-	-	ns
Data setup time	tsds	200	-	-	ns
Data hold time	tsdh	200	-	-	ns
CS serial clock time	tcss	120	-	-	ns
CS serial clock time	tcsh	400	-	-	ns

Note:

*1. Input signal rise/fall time should be less than 12ns

3.3.4 Reset Timing

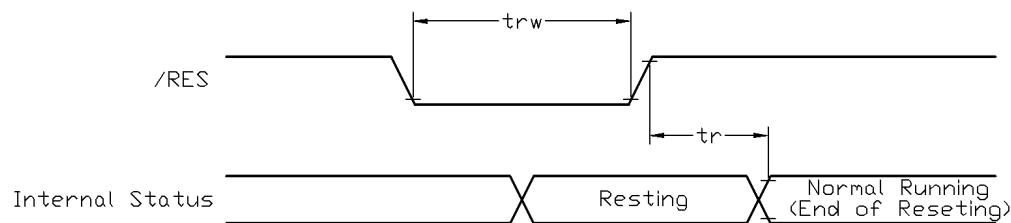

$V_{SS}=0V, V_{DD}=3V, T_{OP}=25^{\circ}C$

Item	Symbol	MIN.	TYP.	MAX.	Unit
Reset time	tr	2	-	-	μs
Reset LOW pulse width	trw	2	-	-	μs

Note:

*1. Input signal rise/fall time should be less than 12ns

4. Function Specifications

4.1 Basic Setting

To drive the LCD module correctly and provide normally display, please use the following setting

- Initial Display Line = 0
- ADC = 0 (normal)
- Normal/Reverse Display = Normal
- Entire Display ON/OFF = OFF (normal)
- LCD Bias = 1/8
- Set Output Status Register = normal
- Set Power Control: voltage follower=ON, voltage booster=ON, voltage regulator=ON
- Display ON/OFF = ON

Note:

*1. These setting/commands should issue the LCD module while start up.

*2. See the Display Commands section for details.

4.2 Resetting the LCD module

The LCD module should be initialized by using /RES terminal.

While turning on the VDD and VSS power supply, maintain /RES terminal at LOW level. After the power supply stabilized, release the reset terminal (/RES=HIGH)

4.3 Display Memory Map

Page address	data	LCD Display (front view)		
0	D0 : D7			
1	D0 : D7			
2	D0 : D7			
3	D0 : D7			
4	D0 : D7			
5	D0 : D7			
6	D0 : D7			
7	D0 : D7			
Column Address		00h	→	7Fh

Note:

*1. Initial Display Line = 0

*2. ADC=0

*3. Output Status Register = normal

4.4 Display Commands

No.	Instructions	Code										Function	
		A0	/RD	/WR	D7	D6	D5	D4	D3	D2	D1		D0
1	Display ON/OFF	0	1	0	1	0	1	0	1	1	1	0 / 1	Turns on LCD when goes high, Turns off LCD when goes low
2	Initial Display Line	0	1	0	0	1	Start display address					Specifies display RAM location for first line of display	
3	Set Page Address	0	1	0	1	0	1	1	Page Address			Set the display RAM page address	
4.1	Set Column Address (Upper-4-bits)	0	1	0	0	0	0	1	Col. Add. Upper			Set the upper-4-bit of column address counter	
4.2	Set column Address (Lower-4-bits)	0	1	0	0	0	0	0	Col. Add. Lower			Set the lower-4-bit of column address counter	
5	Read Status	0	0	1	Status				0	0	0	0	Read the internal status D4=RESET, 1=resetting, 0=normal D5=Display ON/OFF, 1=off, 0=on D6=ADC Flag, D7=BUSY Flag, 1=busy, 0=ready
6	Write Display Data	1	1	0	Display Data							Write data into the display RAM	
7	Read Display Data	1	0	1	Display Data							Read data form the display RAM	
8	ADC Select	0	1	0	1	0	1	0	0	0	0	0 / 1	Sets the Column Address direction 0 = Normal display 1 = flipped in x direction
9	Normal/Reverse Display	0	1	0	1	0	1	0	0	1	1	0 / 1	Normal indication when low Full indication when high
10	Entire Display ON/OFF	0	1	0	1	0	1	0	0	1	0	0 / 1	0 = Normal display 1 = All-on display
11	Set LCD Bias	0	1	0	1	0	1	0	0	0	1	0 / 1	Set the LCD driving voltage bias 0 = 1/8 BIAS 1 = 1/6 BIAS
12	Read-Modify-Write	0	1	0	1	1	1	0	0	0	0	0	Enter the "Read-Modify-Write" mode column address counter will increase in each "Write Display Data", and will not increase in each "Read Display Data command"
13	End	0	1	0	1	1	1	0	1	1	1	0	Clear the "Read-Modify-Write" mode
14	Reset	0	1	0	1	1	1	0	0	0	1	0	Resets the internal functions
15	Set Output Status Register	0	1	0	1	1	0	0	0	0 / 1	*	*	Set the COM scanning direction 0 = Normal display 1 = flipped in y direction * = don't care terms
16	Set Power Control	0	1	0	0	0	1	0	1	Power Status			Set the power circuit operation mode D0 = LCD Supply Voltage Follower D1 = LCD Supply Voltage Regulator D2 = LCD Supply Voltage Booster (1=ON, 0=OFF)
17	Set Electronic Control Register	0	1	0	1	0	0	Electronic Control value			Set Electronic Vol. value (Display contrast value)		
18	Set Standby (Static Indicator control)	0	1	0	1	0	1	0	1	1	0	0 / 1	Set the status, when Power Save 0 = sleep mode will be entered, (static indicator off) 1 = standby mode will be entered (static indicator on)
19	Power Save	-	-	-	-	-	-	-	-	-	-	-	Compound command step 1: display ON/OFF= OFF step 2: Entire Display ON/OFF = ON

Note: *1. Do not use any other command not listed, or the system malfunction may result.
*2. For the details of the Display Commands, please refer to S1D15300 Series data sheet.

4.5 Basic Operating Sequence (example)

4.5.1 Initialization Sequence

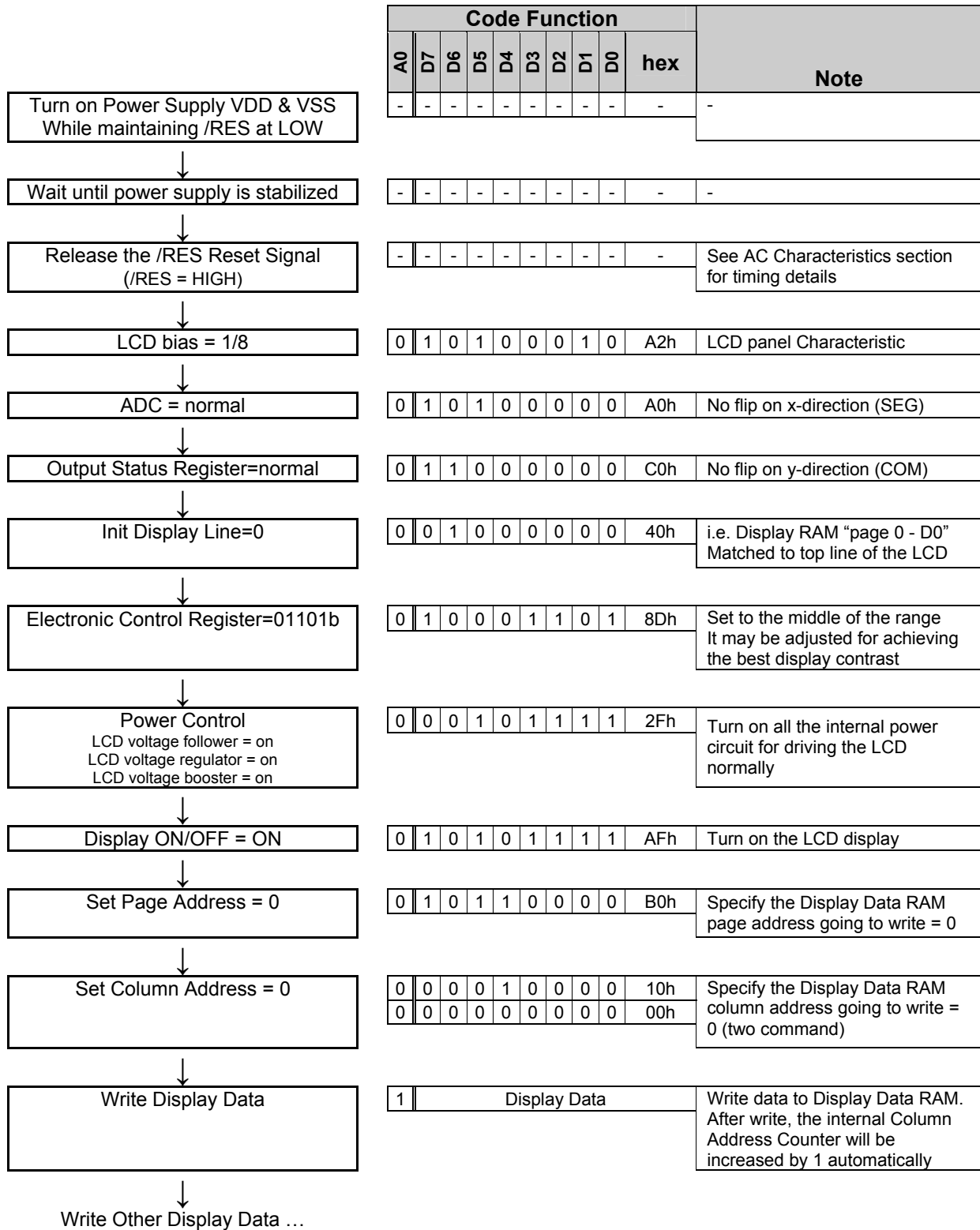

4.5.2 Power Save Sequence (sleep mode)

Going into Sleep Mode (A Compound Command)

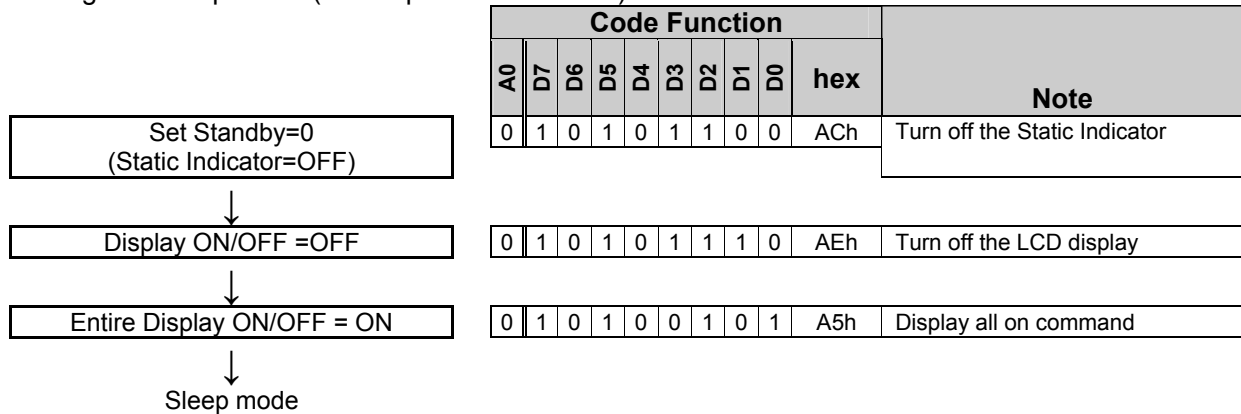

Resume form Sleep mode

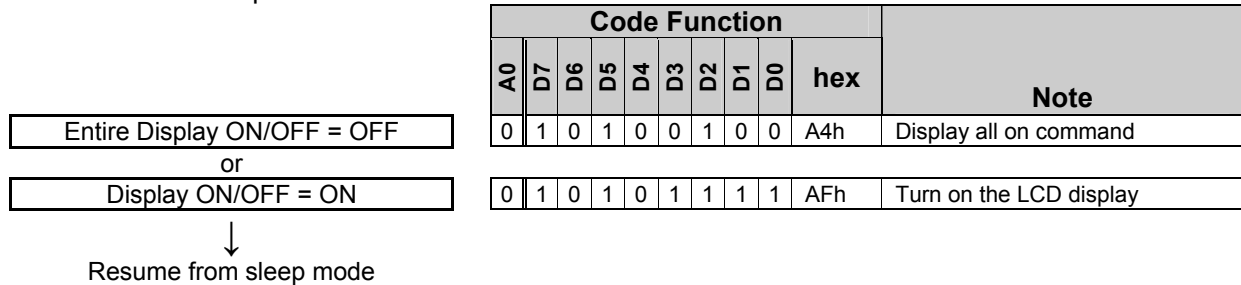

4.5.3 Power off the LCD Module

It recommends that enter sleep mode before power off the LCD module.

4.5.4 Refreshing The LCD Module

It recommends that the operating modes and display contents be refreshed periodically to prevent the effect of unexpected noise.

5. Design and Handling Precaution

1. The LCD panel is made by glass. Any mechanical shock (eg. dropping from high place) will damage the LCD module.
2. Do not add excessive force on the surface of the display, which may cause the Display color change abnormally.
3. The polarizer on the LCD is easily get scratched. If possible, do not remove the LCD protective film until the last step of installation.
4. Never attempt to disassemble or rework the LCD module.
5. Only Clean the LCD with Isopropyl Alcohol or Ethyl Alcohol. Other solvents (eg. water) may damage the LCD.
6. When mounting the LCD module, make sure that it is free from twisting, warping and distortion.
7. Ensure to provide enough space (with cushion) between case and LCD panel to prevent external force adding on it, or it may cause damage to the LCD or degrade the display result.
8. Only hold the LCD module by its side. Never hold LCD module by add force on the heat seal or TAB.
9. Never add force to component of the LCD module. It may cause invisible damage or degrade of the reliability.
10. LCD module could be easily damaged by static electricity. Be careful to maintain an optimum anti-static work environment to protect the LCD module.
11. When peeling off the protective film from LCD, static charge may cause abnormal display pattern. It is normal and will resume to normal in a short while.
12. Take care and prevent get hurt by the LCD panel sharp edge.
13. Never operate the LCD module exceed the absolute maximum ratings.
14. Keep the signal line as short as possible to prevent noisy signal applying to LCD module.
15. Never apply signal to the LCD module without power supply.
16. IC chip (eg. TAB or COG) is sensitive to the light. Strong lighting environment could possibly cause malfunction. Light sealing structure casing is recommend.
17. LCD module reliability may be reduced by temperature shock.
18. When storing the LCD module, avoid exposure to the direct sunlight, high humidity, high temperature or low temperature. They may damage or degrade the LCD module