

Silicon Bipolar MMIC 5 GHz Active Double Balanced Mixer/IF Amp

Technical Data

IAM-82028

Features

- **15 dB RF-IF Conversion Gain from 0.05 - 5 GHz**
- **IF Output from DC to 2 GHz**
- **IF Output P_{1dB} up to +12 dBm**
- **Single Polarity Bias Supply:**
 $V_{CC} = 7$ to 13 V
- **Load-Insensitive Performance**
- **Conversion Gain Flat Over Temperature**
- **Low LO Power Requirements:**
0 dBm Typical
- **Low RF to IF Feedthrough, Low LO Leakage**
- **Hermetic Ceramic Surface Mount Package**

Description

The IAM-82028 is a complete moderate-power double-balanced active mixer housed in a miniature ceramic hermetic surface mount package. It is designed for narrow or wide bandwidth commercial, industrial and military applications having RF inputs up to 5 GHz and IF outputs from DC to 2 GHz. Operation at RF and LO frequencies less than 50 MHz can be achieved using optional external capacitors to ground. The IAM-82028 is particularly well suited for applications that require load-insensitive conversion gain and good spurious signal suppression and moderate dynamic range with minimum LO power. Typical applications include frequency

28 Package

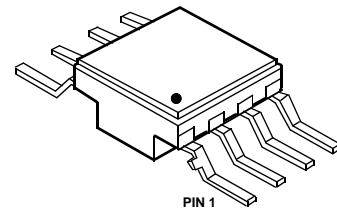

downconversion, modulation, demodulation and phase detection for fiber-optic, GPS satellite navigation, mobile radio, and communications receivers.

The IAM series of Gilbert multiplier-based frequency converters is fabricated using HP's 10 GHz f_T , 25 GHz f_{MAX} ISOSAT™-I silicon bipolar process which uses nitride self-alignment, submicrometer lithography, trench isolation, ion implantation, gold metallization and polyimide inter-metal dielectric and scratch protection to achieve excellent performance, uniformity and reliability.

Typical Biasing Configuration and Functional Block Diagram

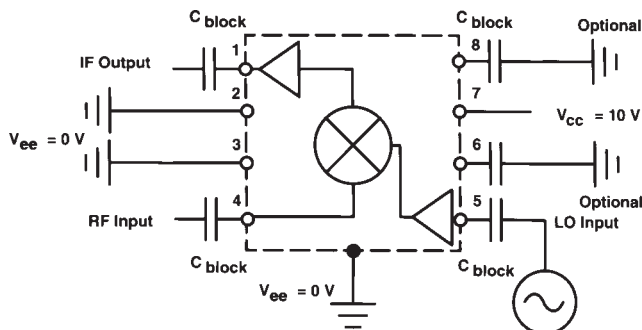

Note: No external BALUNs are required.

Absolute Maximum Ratings

Parameter	Absolute Maximum ^[1]
Device Voltage	15 V
Power Dissipation ^[2,3]	1200 mW
RF Input Power	+14 dBm
LO Input Power	+14 dBm
Junction Temperature	200°C
Storage Temperature	-65°C to 200°C

Thermal Resistance:^[2,4]

$$\theta_{jc} = 45^{\circ}\text{C/W}$$

Notes:

1. Permanent damage may occur if any of these limits are exceeded.
2. $T_{\text{CASE}} = 25^{\circ}\text{C}$.
3. Derate at 22.2 mW/°C for $T_{\text{C}} > 146^{\circ}\text{C}$.
4. See MEASUREMENTS section "Thermal Resistance" in Communications Components Catalog, for more information.

IAM-82028 Electrical Specifications^[1], $T_{\text{A}} = 25^{\circ}\text{C}$

Symbol	Parameters and Test Conditions ^[2] : $V_{\text{CC}} = 10 \text{ V}$, $V_{\text{ee}} = 0 \text{ V}$, $V_{\text{gc}} = 0 \text{ V}$, $Z_{\text{O}} = 50 \Omega$	Units	Min.	Typ.	Max.
G_{C}	Conversion Gain RF = 2 GHz, LO = 1.75 GHz	dB	13.5	15	16.5
$f_{3\text{dB}}^{\text{RF}}$	RF Bandwidth (G_{C} 3 dB Down) IF = 250 MHz	GHz		5.5	
$f_{3\text{dB}}^{\text{IF}}$	IF Bandwidth (G_{C} 3 dB Down) LO = 2 GHz	GHz		0.6	
$P_{1\text{dB}}$	IF Output Power at 1 dB Gain Compression RF = 2 GHz, LO = 1.75 GHz	dBm		8	
IP_3	IF Output Third Order Intercept Point RF = 2 GHz, LO = 1.75 GHz	dBm		18	
NF	SSB Noise Figure RF = 2 GHz, LO = 1.75 GHz	dB		16	
VSWR	RF Port VSWR $f = 0.05$ to 5 GHz			1.5:1	
	LO Port VSWR $f = 0.05$ to 5 GHz			2:1	
	IF Port VSWR $f < 2$ GHz			2.3:1	
RF_{if}	RF Feedthrough at IF Port RF = 2 GHz, LO = 1.75 GHz	dBc		-30	
LO_{if}	LO Leakage at IF Port LO = 1.75 GHz	dBm		-20	
LO_{rf}	LO Leakage at RF Port LO = 1.75 GHz	dBm		-30	
I_{CC}	Supply Current	mA	40	55	65

Note:

1. The recommended operating voltage range for this device is 7 to 13 V. Typical performance as a function of voltage is on the following page.

Typical Performance, $T_A = 25^\circ\text{C}$, $V_{CC} = 10\text{ V}$
RF: -20 dBm at 2 GHz, LO: 0 dBm at 1.75 GHz
(unless otherwise noted)

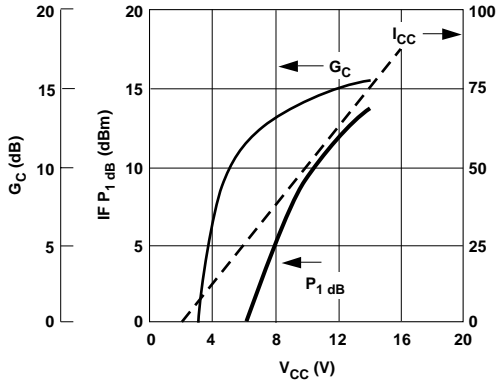

Figure 1. Conversion Gain, IF P_1 dB and I_{CC} Current vs. V_{CC} Bias Voltage.

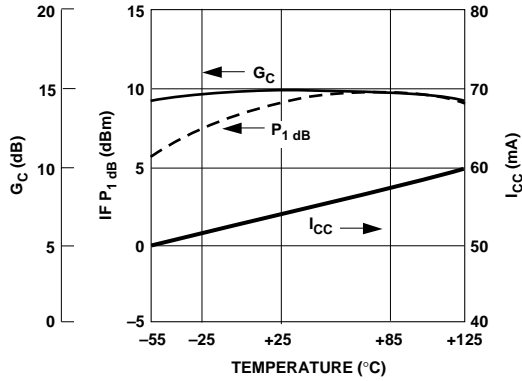

Figure 2. Conversion Gain, IF P_1 dB and I_{CC} Current vs. Case Temperature.

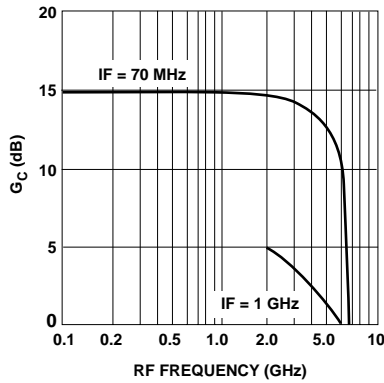

Figure 3. Typical RF to IF Conversion Gain vs. RF Frequency, $T_A = 25^\circ\text{C}$ (Low Side LO).

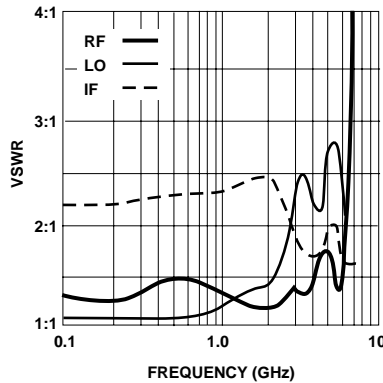

Figure 4. RF, LO and IF Port VSWR vs. Frequency.

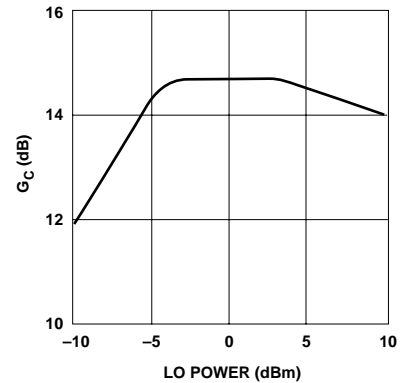

Figure 5. RF to IF Conversion Gain vs. LO Power.

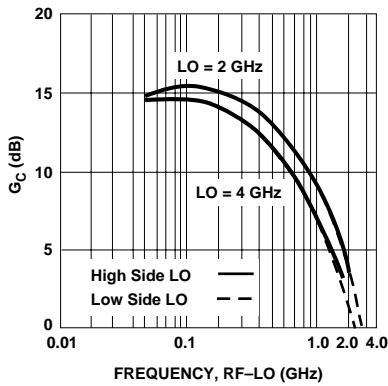

Figure 6. RF to IF Conversion Gain vs. IF Frequency.

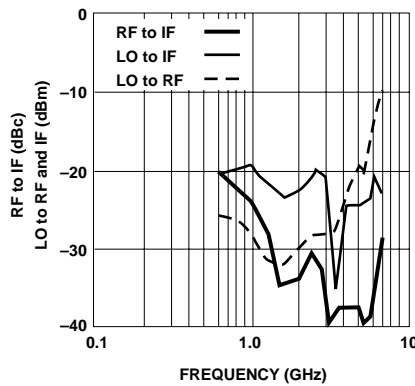

Figure 7. RF Feedthrough Relative to IF Carrier, dBm LO to RF and IF Leakage vs. Frequency.

HARMONIC LO ORDER	0	1	2	3	4	5
0	—	23	40	>75	>75	>75
1	12	0	52	60	>75	>75
2	6	35	43	>75	>75	>75
3	27	18	59	74	>75	>75
4	22	38	52	>75	>75	>75
5	41	36	73	74	>75	>75
	0	1	2	3	4	5

HARMONIC RF ORDER
 $X_{mn} = P_{if} - P(m \cdot rf - n \cdot lo)$

Figure 8. Harmonic Intermodulation Suppression (dB Below Desired Output) RF at 1 GHz, LO at 0.752 GHz, IF at 0.248 GHz.

Package Dimensions

28Package

