

### Features

- Double superhet architecture for high degree of image rejection
- FSK for digital data and FM reception for analog signal transmission
- FM/FSK demodulation either with phase-coincidence or PLL demodulator
- Low current consumption in active mode and very low standby current
- Switchable LNA gain for improved dynamic range
- AFC feature allows wide carrier frequency acceptance range
- RSSI allows signal strength indication and ASK detection
- Surface mount package LQFP44

### Ordering Information

<b>Part No.</b>	<b>Temperature Range</b>	<b>Package</b>
TH7110	-40 °C to 85 °C	LQFP44

### Application Examples

- General digital and analog 315 MHz or 433 MHz ISM band usage
- Low-power telemetry
- Alarm and security systems
- Keyless car and central locking
- Pagers

### Technical Data Overview

- Input frequency range: 300 MHz to 450 MHz
- Power supply range: 2.5 V to 5.5 V for double conversion and 2.7 V to 5.5 V for single conversion
- Temperature range: -40 °C to +85 °C
- Operating current: 6.5 mA at low gain and 8.2 mA at high gain mode
- Standby current: < 100 nA
- Sensitivity: -111 dBm<sup>1)</sup> with 40 kHz second IF filter BW (incl. SAW front-end filter loss)
- Sensitivity: -104 dBm<sup>2)</sup> with 150 kHz second IF filter BW (incl. SAW front-end filter loss)
- Range of first IF: 10 MHz to 80 MHz
- Range of second IF: 455 kHz to 21.4 MHz
- Maximum input level: -10 dBm at ASK and 0 dBm at FSK
- Image rejection: > 65 dB (e.g. with SAW front-end filter and at 10.7 MHz 2<sup>nd</sup> IF)
- Spurious emission: < -70 dBm
- Input frequency acceptance: ±50 kHz (with AFC option)
- RSSI range: 70 dB
- Frequency deviation range: ±5 kHz to ±120 kHz
- Maximum data rate: 80 kbit/s NRZ
- Maximum analog modulation frequency: 15 kHz

<sup>1)</sup> at ± 8 kHz FSK deviation, BER = 3·10<sup>-3</sup> and phase-coincidence demodulation

<sup>2)</sup> at ± 50 kHz FSK deviation, BER = 3·10<sup>-3</sup> and phase-coincidence demodulation

## General Description

The TH7110 receiver IC consists of the following building blocks:

- PLL synthesizer (PLL SYNTH) for generation of the first and second local oscillator signals LO1 and LO2
- Parts of the PLL SYNTH are the high-frequency VCO1, the feedback dividers DIV\_8 and DIV\_2, a phase-frequency detector (PFD) with charge pump (CP) and a crystal-based reference oscillator (RO)
- Low-noise amplifier (LNA) for high-sensitivity RF signal reception
- First mixer (MIX1) for down-conversion of the RF signal to the first IF (IF1)
- second mixer (MIX2) for down-conversion of the IF1 to the second IF (IF2)
- IF amplifier (IFA) to amplify and limit the IF2 signal and for RSSI generation
- Phase coincidence demodulator (DEMOD) with third mixer (MIX3) to demodulate the IF signal
- Operational amplifier (OA) for data slicing, filtering, ASK detection and automatic-frequency control (AFC)
- Bias circuitry for bandgap biasing and circuit shutdown

With the TH7110 receiver chip, various circuit configurations can be arranged in order to meet a number of different customer requirements. For FM/FSK reception the IF tank used in the phase coincidence demodulator can be constituted either by a ceramic resonator or an LC tank (optionally with varactor to create an AFC circuit). In PLL demodulator configuration, the multiplier MIX3 forms a phase comparator. In ASK configuration, the RSSI signal is feed to an ASK detector, which is constituted by the operational amplifier. The second VCO (VCO2) can be used either as the VCO of a PLL demodulator or as the LO2 source of a second external PLL in a multi-channel system. The following table briefly summarizes the various configurations.

	Single-conversion configuration	Double-conversion configuration
<b>FM/FSK</b>	narrow-band RX with ceramic demodulation tank	narrow-band RX with ceramic demodulation tank
<b>FM/FSK</b>	wide-band RX with LC demod. tank and AFC	wide-band RX with LC demod. tank and AFC
<b>FM/FSK</b>	extended sensitivity RX with PLL demodulator	extended sensitivity RX with PLL demodulator
<b>FM/FSK</b>		multi-channel RX with ceramic demodulation tank and external channel synthesizer
<b>ASK</b>	RX with RSSI-based demodulation	RX with RSSI-based demodulation
<b>ASK</b>		RX with RSSI-based demodulation and external channel synthesizer

The preferred superheterodyne configuration is **double conversion** where MIX1 and MIX2 are driven by the internal local oscillator signals LO1 and LO2, respectively. This allows a **high degree of image rejection**, achieved in conjunction with an RF front-end filter. Efficient RF front-end filtering is realized by using a SAW, ceramic or helix filter in front of the LNA and by adding a LC filter at the LNA output.

It is also possible to use the TH7110 in **single-conversion** configuration. This can be achieved by switching the LO2 input of MIX2 from the on-chip PLL synthesizer to the pin IN\_MIX2 by means of an internal switch (done via pin SW\_MIX2). Now MIX2 operates as an amplifier for the IF1 signal if an external pull-down resistor at pin IN\_MIX2 is added.

The same setting of MIX2 can be used for **multi-channel applications**. In this situation IN\_MIX2 must be driven by an external LO2 signal. This signal can be generated by the VCO2, which is mainly a bipolar transistor that can be configured as a varactor-tuned VCO. Furthermore, a second external PLL for channel selection via LO2 tuning is required. This may be arranged by using a PLL synthesizer chip that can be controlled through a 3-wire bus serial interface. The reference signal for the external PLL synthesizer can be directly taken from the crystal-based reference oscillator RO.

Block Diagram

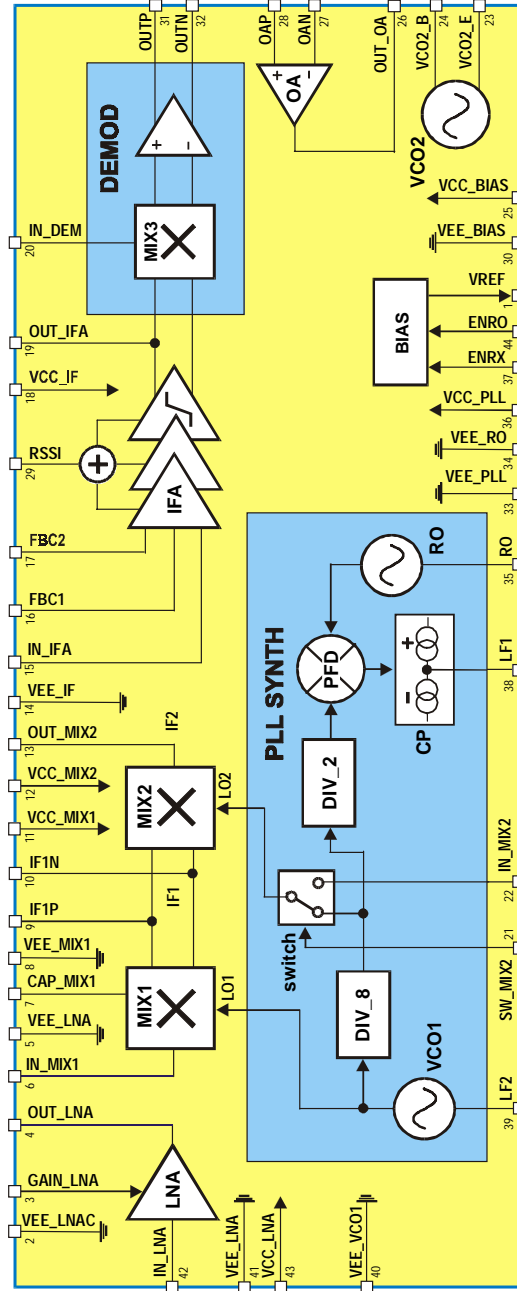

Fig. 1: TH7110 block diagram

### Frequency Planning

Frequency planning is straightforward for single-conversion applications because there is only one IF that might be chosen, and then the only possible choice is low-side or high-side injection of the LO1 signal (which is now the one and only LO signal in the receiver).

The receiver's double-conversion architecture requires careful frequency planning. Besides the desired RF input signal, there are a number of spurious signals that may cause an undesired response at the output. Among them are the image of the RF signal (that must be suppressed by the RF front-end filter), spurious signals injected to the first IF (IF1) and their images which could be mixed down to the same second IF (IF2) as the desired RF signal (they must be suppressed by the LC filter at IF1 and/or by low-crosstalk design).

By configuring the TH7110 for double conversion and using its internal PLL synthesizer with fixed feedback divider ratios of  $N1 = 8$  (DIV\_8) and  $N2 = 2$  (DIV\_2), four types of down-conversion are possible: low-side injection of LO1 and LO2 (**low-low**), LO1 low-side and LO2 high-side (**low-high**), LO1 high-side and LO2 low-side (**high-low**) or LO1 and LO2 high-side (**high-high**). The following table summarizes some equations that are useful to calculate the crystal reference frequency (REF), the first IF (IF1) and the VCO1 or first LO frequency (LO1), respectively, for a given RF and second IF (IF2).

Injection type	high-high	low-low	high-low	low-high
REF	$(RF - IF2)/14$	$(RF - IF2)/18$	$(RF + IF2)/14$	$(RF + IF2)/18$
LO1	$16 \bullet REF$	$16 \bullet REF$	$16 \bullet REF$	$16 \bullet REF$
IF1	$LO1 - RF$	$RF - LO1$	$LO1 - RF$	$RF - LO1$
LO2	$2 \bullet REF$	$2 \bullet REF$	$2 \bullet REF$	$2 \bullet REF$
IF2	$LO2 - IF1$	$IF1 - LO2$	$IF1 - LO2$	$LO2 - IF1$

The following table depicts generated, desired, possible images and some undesired signals considering the examples of 315 MHz and 433.6 MHz RF reception at IF2 = 10.7 MHz.

Signal type	RF = 315 MHz	RF = 315 MHz	RF = 315 MHz	RF = 315 MHz	RF = 433.6 MHz	RF = 433.6 MHz	RF = 433.6 MHz	RF = 433.6 MHz
Injection type	high-high	low-low	<b>high-low</b>	low-high	high-high	<b>low-low</b>	high-low	low-high
REF / MHz	21.73571	16.90556	<b>23.26429</b>	18.09444	30.20714	<b>23.49444</b>	31.73571	24.68333
LO1 / MHz	347.77143	270.48889	<b>372.22857</b>	289.51111	483.31429	<b>375.91111</b>	507.77143	394.93333
IF1 / MHz	32.77143	44.51111	<b>57.22857</b>	25.48889	49.71429	<b>57.68889</b>	74.17143	38.66667
LO2 / MHz	43.47143	33.81111	<b>46.52857</b>	36.18889	60.41429	<b>46.98889</b>	63.47143	49.36667
RF image/MHz	380.54286	225.97778	<b>429.45714</b>	264.02222	533.02857	<b>318.22222</b>	581.94286	356.26667
IF1 image/MHz	54.17143	23.11111	<b>35.82857</b>	46.88889	71.11429	<b>36.28889</b>	52.77143	60.06667

The selection of the reference crystal frequency is based on some assumptions. As for example: the first IF and the image frequencies should not be in a radio band where strong interfering signals might occur (because they could represent parasitic receiving signals), the LO1 signal should be in the range of 300 MHz to 430 MHz (because this is the optimum frequency range of the VCO1). Furthermore the first IF should be as high as possible to achieve highest RF image rejection. The columns in bold depict the selected frequency plans to receive at 315 MHz and 433.6 MHz, respectively.

### Pin Definition and Description

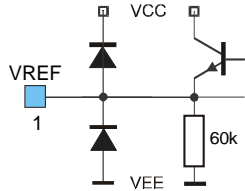
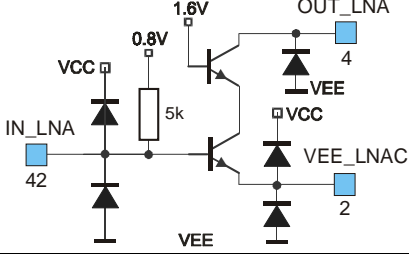
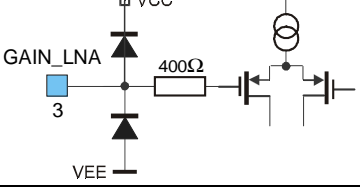
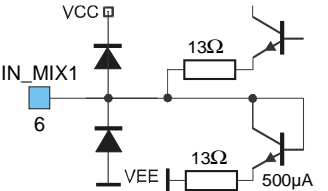
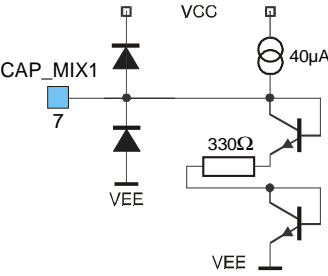
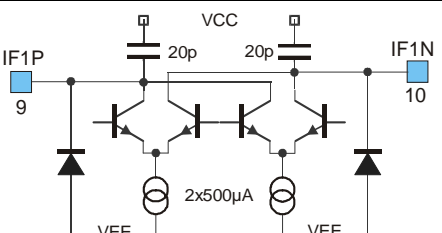
Pin No.	Name	I/O Type	Functional Schematic	Description
1	VREF	analog output		reference voltage output, approx. 1.23V
4	OUT_LNA	analog output		LNA open-collector output, to be connected to external LC tank that resonates at RF
42	IN_LNA	analog input		LNA input, approx. 26Ω single-ended
2	VEE_LNAC	ground		ground of LNA core (cascode)
3	GAIN_LNA	analog input		LNA gain control (CMOS input with hysteresis)
5	VEE_LNA	ground		LNA biasing ground
6	IN_MIX1	analog input		MIX1 input, approx. 33Ω single-ended
7	CAP_MIX1	analog I/O		connection for MIX1 blocking capacitor
8	VEE_MIX1	ground		MIX1 ground
9	IF1P	analog I/O		open-collector output, to be connected to external LC tank that resonates at first IF
10	IF1N	analog I/O		open-collector output, to be connected to external LC tank that resonates at first IF

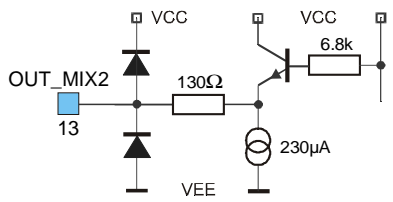
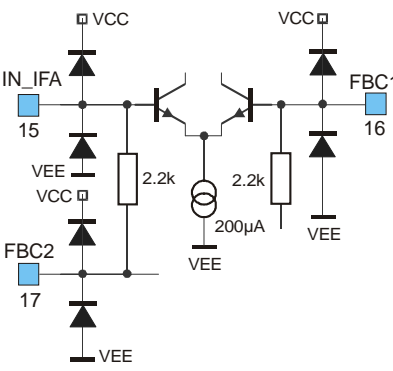
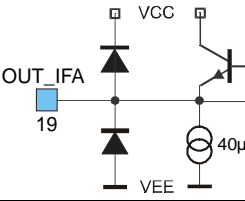
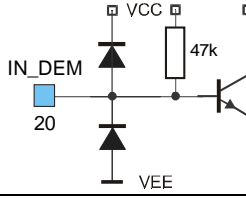
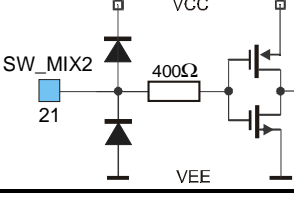
Pin No.	Name	I/O Type	Functional Schematic	Description
11	VCC_MIX1	supply		MIX1 positive supply
12	VCC_MIX2	supply		MIX2 positive supply
13	OUT_MIX2	analog output		MIX2 output, approx. 330Ω output impedance
14	VEE_IF	ground		ground of MIX2, IFA and DEMOD
15	IN_IFA	analog input		IFA input, approx. 2.2kΩ input impedance
16	FBC1	analog I/O		to be connected to external IFA feedback capacitor
17	FBC2	analog I/O		to be connected to external IFA feedback capacitor
18	VCC_IF	supply		positive supply for IFA, DEMOD and VCO2
19	OUT_IFA	analog I/O		IFA output and MIX3 input (of DEMOD)
20	IN_DEM	analog input		DEMOM input, to MIX3 core
21	SW_MIX2	digital input		input selection for LO2 input port of MIX2

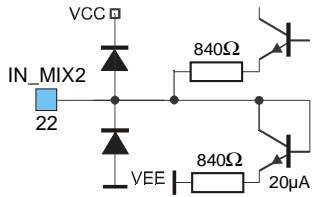
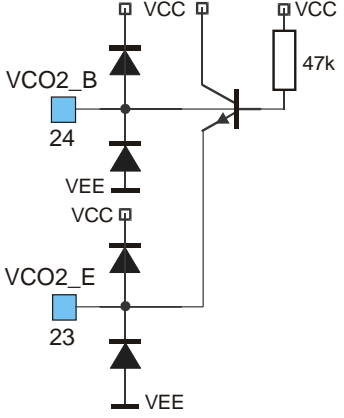
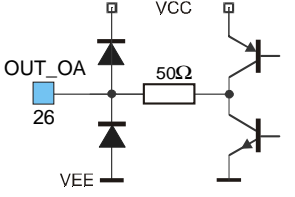
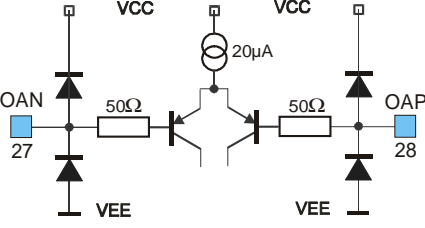
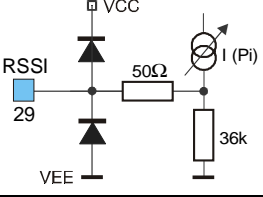
Pin No.	Name	I/O Type	Functional Schematic	Description
22	IN_MIX2	analog input		external LO2 input port of MIX2, approx. 1kΩ single-ended
24	VCO2_B	analog input		VCO2 input, base of a bipolar transistor
23	VCO2_E	analog output		VCO2 output, emitter of a bipolar transistor
25	VCC_BIAS	supply		positive supply of general bias system and OA
26	OUT_OA	analog output		OA output, 40uA current drive capability
27	OAN	analog input		negative OA input, input voltage limited to approx. 0.7 V <sub>pp</sub> between pins OAP and OAN
28	OAP	analog input		positive OA input, input voltage limited to approx. 0.7 V <sub>pp</sub> between pins OAP and OAN
29	RSSI	analog output		RSSI output, for RSSI and ASK detection, approx. 36kΩ output impedance
30	VEE_BIAS	ground		ground for general bias system and OA

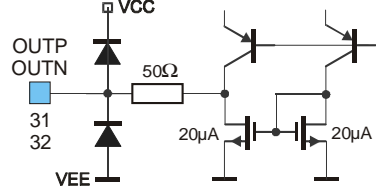
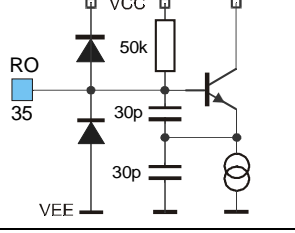
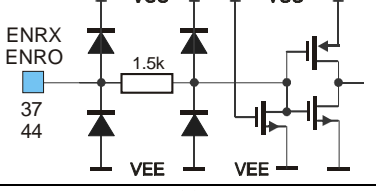
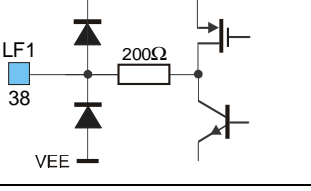
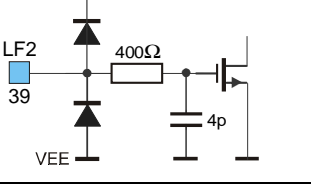
Pin No.	Name	I/O Type	Functional Schematic	Description
31	OUTP	analog output		FSK/FM positive output, output impedance of 100kΩ to 300kΩ
32	OUTN	analog output		FSK/FM negative output, output impedance of 100kΩ to 300kΩ
33	VEE_PLL	ground		ground of dividers and PFD
34	VEE_RO	ground		RO ground
35	RO	analog input		RO input, Colpitts type oscillator with internal feedback capacitors
36	VCC_PLL	supply		positive supply of RO, DIV, PFD and charge pump
37	ENRX	digital input		mode control input (CMOS input)
44	ENRO	digital input		mode control input (CMOS input)
38	LF1	analog output		charge pump output
39	LF2	analog input		VCO1 control input
40	VEE_VCO1	ground		ground of VCO1 and charge pump
41	VEE_LNA	ground		ground of LNA biasing
43	VCC_LNA	supply		positive supply of LNA biasing



## Technical Data

### Mode Configurations

ENRX	ENRO	Mode	Description
0	0	SBY	standby mode
0	1	RO only	only reference oscillator active
1	0	ON	entire chip active
1	1	ON	entire chip active

**Note:** ENRX and ENRO are pulled down internally

### Second Mixer Input

IN_MIX2	SW_MIX2	Mode
External LO2	0	double conversion with external LO2
Ext. pull-down res. (15 k $\Omega$ )	0	single conversion
N/C	1	double conversion with internal LO2

### LNA Gain Control

V <sub>GAIN_LNA</sub>	Mode	Description
< 0.8 V	HIGH GAIN	LNA set to high gain by voltage at GAIN_LNA
> 1.4 V	LOW GAIN	LNA set to low gain by voltage at GAIN_LNA

**Note:** hysteresis between gain modes to ensure stability

### Absolute Maximum Ratings

Parameter	Symbol	Condition / Note	Min	Max	Unit
Supply voltage	V <sub>CC</sub>		0	7.0	V
Input voltage	V <sub>IN</sub>		- 0.3	V <sub>CC</sub> +0.3	V
Input RF level	P <sub>imax</sub>	no damage		10	dBm
Storage temperature	T <sub>STG</sub>		-40	+125	°C
Electrostatic discharge	ESD	human body model, MIL STD 833D method 3015.7, all pins except OUT_IFA pin OUT_IFA	-500 -500	+500 +250	V V

### Normal Operating Conditions

Parameter	Symbol	Condition	Min	Max	Unit
Supply voltage for double conv.	V <sub>CC, DC</sub>		2.5	5.5	V
Supply voltage for single conv.	V <sub>CC, SC</sub>		2.7	5.5	V
Operating temperature	T <sub>a</sub>		-40	+85	°C
Input frequency	f <sub>i</sub>		300	450	MHz
Frequency deviation	$\Delta$ f	at FM or FSK	$\pm$ 5	$\pm$ 120	kHz
FSK data rate	R <sub>FSK</sub>	NRZ		40	kbit/s
FM bandwidth	f <sub>m</sub>			15	kHz
ASK data rate	R <sub>ASK</sub>	NRZ		80	kbit/s

## DC Characteristics

all parameters under normal operating conditions, unless otherwise stated;  
typical values at  $T_a = 23\text{ °C}$  and  $V_{cc} = 3\text{ V}$

Parameter	Symbol	Condition	Min	Typ	Max	Unit
Standby current	$I_{SBY}$	ENRX=0			100	nA
Total supply current at low gain	$I_{cc, low}$	ENRX=1, LNA at LOW GAIN	5.0	6.5	8.0	mA
Total supply current at high gain	$I_{cc, high}$	ENRX=1, LNA at HIGH GAIN	6.5	8.2	10.0	mA
Opamp input offset voltage	$V_{offs}$		-20		20	mV
Opamp input offset current	$I_{offs}$	$I_{OAP} - I_{OAN}$	-50		50	nA
Opamp input bias current	$I_{bias}$	$0.5 * (I_{OAP} + I_{OAN})$	-100		100	nA
RSSI voltage at low input level	$V_{RSSI, low}$	$P_i = -65\text{ dBm}$ , LNA at LOW GAIN	0.5	1.0	1.5	V
RSSI voltage at high input level	$V_{RSSI, high}$	$P_i = -35\text{ dBm}$ , LNA at LOW GAIN	1.25	1.9	2.45	V

## AC System Characteristics

all parameters under normal operating conditions, unless otherwise stated;  
all parameters based on test circuits for FSK (Fig. 2), FM (Fig. 4) and ASK (Fig. 5), respectively;  
typical values at  $T_a = 23\text{ °C}$  and  $V_{cc} = 3\text{ V}$ , RF at 433.6 MHz, second IF at 10.7 MHz

Parameter	Symbol	Condition	Min	Typ	Max	Unit
Start-up time – fast mode FSK/FM	$T_{fast}$	ENRX from 0 to 1, ENRO = 1, valid data at output			0.4	ms
Start-up time – slow mode FSK/FM	$T_{slow}$	ENRX from 0 to 1, ENRO = 0, valid data at output			0.9	ms
Start-up time – ASK	$T_{ASK}$	depends on ASK de- tector time constant and start-up mode, valid data at output			$R3 \cdot C13$ + $T_{fast}$ (or $T_{slow}$ )	ms
Input sensitivity – FSK (narrow band)	$P_{min, n}$	$B_{IF2} = 40\text{ kHz}$ $\Delta f = \pm 15\text{ kHz}$ (FSK/FM) $BER \leq 3 \cdot 10^{-3}$		-111		dBm
Input sensitivity – FSK (wide band)	$P_{min, w}$	$B_{IF2} = 150\text{ kHz}$ $\Delta f = \pm 50\text{ kHz}$ (FSK/FM) $BER \leq 3 \cdot 10^{-3}$		-104		dBm
Input sensitivity – ASK (narrow band)	$P_{minA, n}$	$B_{IF2} = 40\text{ kHz}$ $BER \leq 3 \cdot 10^{-3}$		-109		dBm
Input sensitivity – ASK (wide band)	$P_{minA, w}$	$B_{IF2} = 150\text{ kHz}$ $BER \leq 3 \cdot 10^{-3}$		-106		dBm
Maximum input signal – FSK/FM	$P_{max, FM}$	$BER \leq 3 \cdot 10^{-3}$ LNA at LOW GAIN		0		dBm
Maximum input signal – ASK	$P_{max, ASK}$	$BER \leq 3 \cdot 10^{-3}$ LNA at LOW GAIN		-10		dBm
Spurious emission	$P_{spur}$				-70	dBm
Image rejection	$\Delta P_{imag}$			65		dB
Blocking immunity	$\Delta P_{block}$	$\Delta f_{block} > \pm 2\text{ MHz}$ , note 1		57		dB
VCO gain	$K_{VCO}$			250		MHz/V
Charge pump current	$I_{CP}$			60		$\mu\text{A}$

**Notes:** 1. desired signal with FSK/FM or ASK modulation, CW blocking signal

Test Circuits

FSK Reception

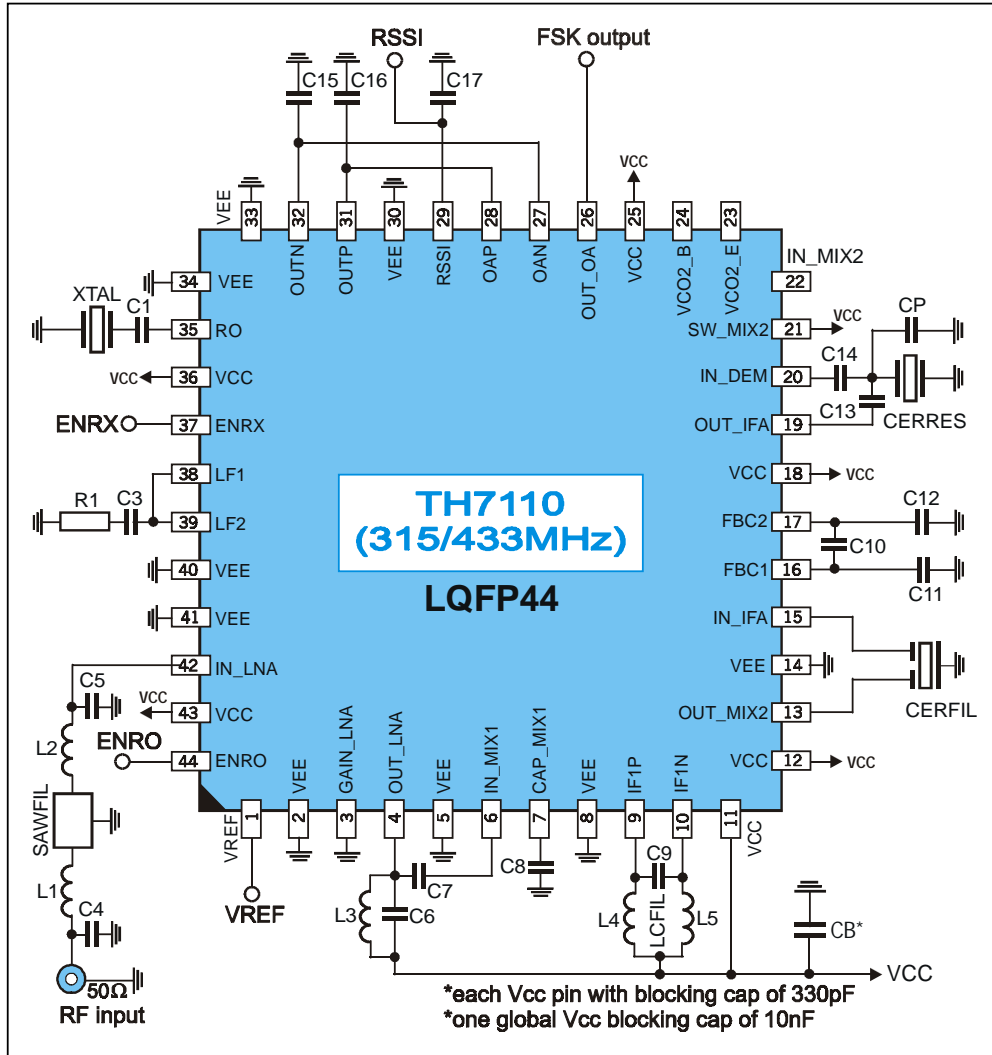

Fig. 2: Test circuit for FSK reception

FSK test circuit component list to Fig. 2

Part	Size	Value / Type	Tolerance	Description
C1	0805	15 pF	±10%	crystal series capacitor
C3	0805	1 nF	±10%	loop filter capacitor
C4	0603	3.3 pF	±5%	capacitor to match to SAW filter input
C5	0603	3.3 pF	±5%	capacitor to match to SAW filter output
C6	0603	4.7 pF	±5%	LNA output tank capacitor
C7	0603	2.2 pF	±5%	MIX1 input matching capacitor
C8	0603	330 pF	±10%	MIX1 blocking capacitor
C9	0603	27 pF	±5%	IF1 tank capacitor
C10	0805	33 nF	±10%	IFA feedback capacitor
C11	0603	1 nF	±10%	IFA feedback capacitor
C12	0603	1 nF	±10%	IFA feedback capacitor
C13	0603	1.5 pF	±5%	DEMODO phase-shift capacitor
C14	0603	680 pF	±10%	DEMODO coupling capacitor
CP	0805	10 – 12 pF	±5%	CERRES parallel capacitor
C15	0805	10 – 47 pF	±5%	demodulator output low-pass capacitor, depending on data rate
C16	0805	10 – 47 pF	±5%	demodulator output low-pass capacitor, depending on data rate
C17	0603	330 pF	±10%	RSSI output low-pass capacitor
R1	0805	10 kΩ	±10%	loop filter resistor
L1	0603	33 nH	±5%	inductor to match SAW filter
L2	0603	33 nH	±5%	inductor to match SAW filter
L3	0603	15 nH	±5%	LNA output tank inductor
L4	0805	100 nH	±5%	IF1 tank inductor
L5	0805	100 nH	±5%	IF1 tank inductor
XTAL	HC49-SMD	<b>23.49444 MHz</b> @ RF = 433.6 MHz	±25ppm calibration ±30ppm temp.	fundamental-mode crystal, C <sub>load</sub> = 10 pF to 15pF, C <sub>0, max</sub> = 7 pF, R <sub>m, max</sub> = 50 Ω
SAWFIL	QCC8C	<b>B3555</b> @ RF = 433.6 MHz	B <sub>3dB</sub> = 860 kHz ±100 kHz (f <sub>0</sub> = 433.92 MHz)	low-loss SAW filter from EPCOS
CERFIL	leaded type	SFE10.7MFP @ B <sub>IF2</sub> = 40 kHz	TBD	ceramic filter from Murata
	SMD type	SFECV10.7MJS-A @ B <sub>IF2</sub> = 150 kHz	±40 kHz	
CERRES	SMD type	CDACV10.7MG18-A		ceramic demodulator tank from Murata

NIP – not in place, may be used optionally

**FSK Circuit with AFC and Ceramic Resonator Tolerance Compensation**

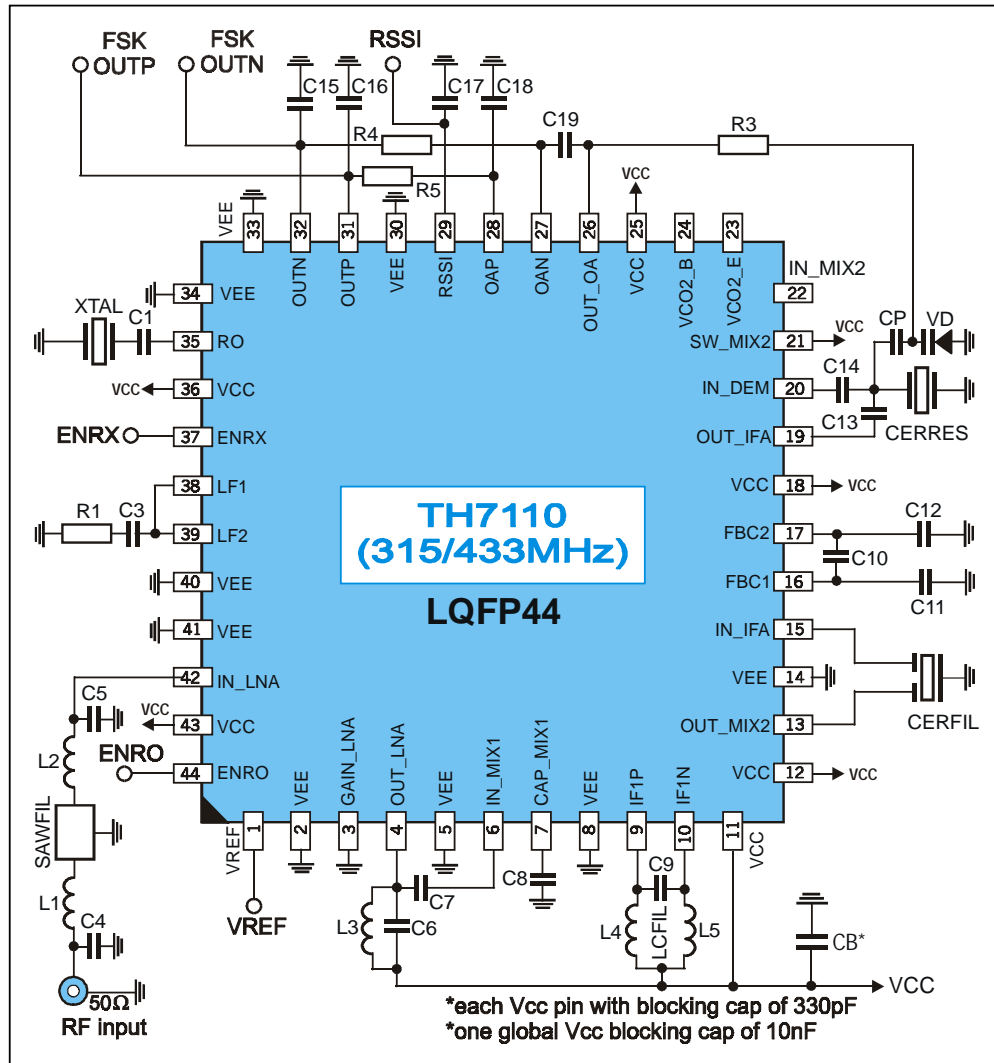

Fig. 3: Test circuit for FSK with AFC and resonator compensation

**Circuit Feature**

- Improves input frequency acceptance range up to  $RF_{nom} \pm 50$  kHz
- Eliminates calibration tolerances of ceramic resonator
- Eliminates temperature tolerances of ceramic resonator
- Non-inverted and inverted CMOS-compatible outputs

### FSK test circuit with AFC component list to Fig. 3

Part	Size	Value / Type	Tolerance	Description
C1	0805	15 pF	±10%	crystal series capacitor
C3	0805	1 nF	±10%	loop filter capacitor
C4	0603	3.3 pF	±5%	capacitor to match to SAW filter input
C5	0603	3.3 pF	±5%	capacitor to match to SAW filter output
C6	0603	4.7 pF	±5%	LNA output tank capacitor
C7	0603	2.2 pF	±5%	MIX1 input matching capacitor
C8	0603	330 pF	±10%	MIX1 blocking capacitor
C9	0603	27 pF	±5%	IF1 tank capacitor
C10	0805	33 nF	±10%	IFA feedback capacitor
C11	0603	1 nF	±10%	IFA feedback capacitor
C12	0603	1 nF	±10%	IFA feedback capacitor
C13	0603	1.5 pF	±5%	DEMODO phase-shift capacitor
C14	0603	680 pF	±10%	DEMODO coupling capacitor
CP	0805	27 pF	±5%	ceramic resonator loading capacitor
C15	0805	10 – 47 pF	±5%	demodulator output low-pass capacitor, depending on data rate
C16	0805	10 – 47 pF	±5%	demodulator output low-pass capacitor, depending on data rate
C17	0603	330 pF	±10%	RSSI output low-pass capacitor
C18		33 nF	±10%	integrator capacitor, fixed
C19	0805	33 nF	±10%	integrator capacitor, @ 0.5 to 2 kbit/s NRZ
		10 nF		integrator capacitor, @ 2 to 20 kbit/s NRZ
		1 nF		integrator capacitor, @ 20 to 40 kbit/s NRZ
R1	0805	10 kΩ	±10%	loop filter resistor
R3	0805	100 kΩ	±10%	varactor diode biasing resistor
R4	0805	680 kΩ	±10%	integrator resistor
R5	0805	680 kΩ	±10%	integrator resistor
L1	0603	33 nH	±5%	inductor to match SAW filter
L2	0603	33 nH	±5%	inductor to match SAW filter
L3	0603	15 nH	±5%	LNA output tank inductor
L4	0805	100 nH	±5%	IF1 tank inductor
L5	0805	100 nH	±5%	IF1 tank inductor
VD	SOD-323	BB535		varactor diode from Infineon
XTAL	HC49-SMD	<b>23.49444 MHz</b> @ RF = 433.6 MHz	±25ppm calibration ±30ppm temp.	fundamental-mode crystal, C <sub>load</sub> = 10 pF to 15pF, C <sub>0, max</sub> = 7 pF, R <sub>m, max</sub> = 50 Ω
SAWFIL	QCC8C	<b>B3555</b> @ RF = 433.6 MHz	B <sub>3dB</sub> = 860 kHz ±100 kHz (f <sub>0</sub> = 433.92 MHz)	low-loss SAW filter from EPCOS
CERFIL	leaded type	SFE10.7MFP @ B <sub>IF2</sub> = 40 kHz	TBD	ceramic filter from Murata
	SMD type	SFECV10.7MJS-A @ B <sub>IF2</sub> = 150 kHz	±40 kHz	
CERRES	SMD type	CDACV10.7MG18-A		ceramic demodulator tank from Murata

NIP – not in place, may be used optionally

FM Reception

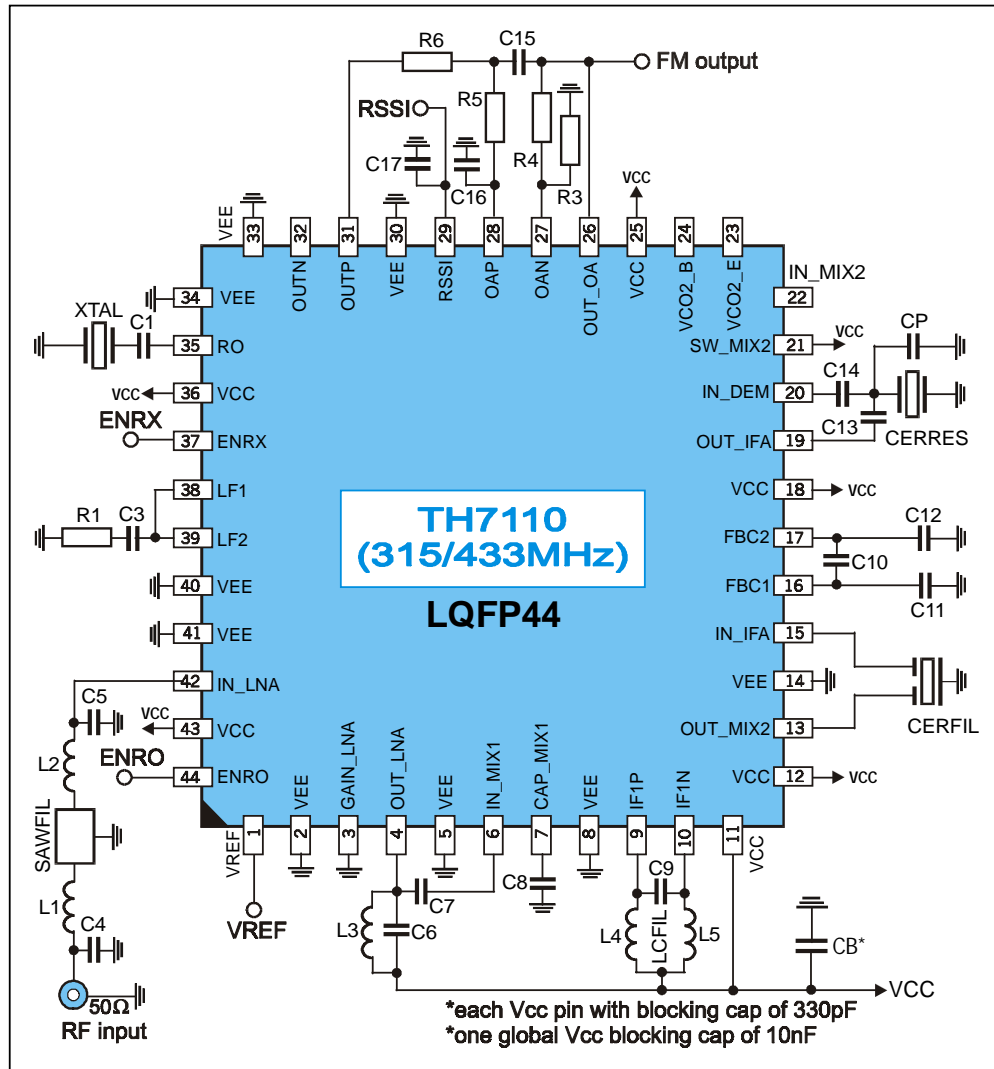

Fig. 4: Test circuit for FM reception

FM test circuit component list to Fig. 4

Part	Size	Value / Type	Tolerance	Description
C1	0805	15 pF	±10%	crystal series capacitor
C3	0805	1 nF	±10%	loop filter capacitor
C4	0603	3.3 pF	±5%	capacitor to match to SAW filter input
C5	0603	3.3 pF	±5%	capacitor to match to SAW filter output
C6	0603	4.7 pF	±5%	LNA output tank capacitor
C7	0603	2.2 pF	±5%	MIX1 input matching capacitor
C8	0603	330 pF	±10%	MIX1 blocking capacitor
C9	0603	27 pF	±5%	IF1 tank capacitor
C10	0805	33 nF	±10%	IFA feedback capacitor
C11	0603	1 nF	±10%	IFA feedback capacitor
C12	0603	1 nF	±10%	IFA feedback capacitor
C13	0603	1.5 pF	±5%	DEMODO phase-shift capacitor
C14	0603	680 pF	±10%	DEMODO coupling capacitor
CP	0805	10 – 12 pF	±5%	CERRES parallel capacitor
C15	0805	100 pF	±5%	sallen-Key low-pass filter capacitor, to set cut-off frequency
C16	0805	100 pF	±5%	sallen-Key low-pass filter capacitor, to set cut-off frequency
C17	0603	330 pF	±10%	RSSI output low-pass capacitor
R1	0805	10 kΩ	±10%	loop filter resistor
R3	0805	12 kΩ	±5%	sallen-key filter resistor, to set desired filter characteristic
R4	0805	6.8 kΩ	±5%	sallen-key filter resistor, to set desired filter characteristic
R5	0805	33 kΩ	±5%	sallen-key filter resistor, to set cut-off frequency
R6	0805	33 kΩ	±5%	sallen-key filter resistor, to set cut-off frequency
L1	0603	33 nH	±5%	inductor to match SAW filter
L2	0603	33 nH	±5%	inductor to match SAW filter
L3	0603	15 nH	±5%	LNA output tank inductor
L4	0603	100 nH	±5%	IF1 tank inductor
L5	0603	100 nH	±5%	IF1 tank inductor
XTAL	HC49-SMD	<b>23.49444 MHz</b> @ RF = 433.6 MHz	±25ppm calibration ±30ppm temp.	fundamental-mode crystal, C <sub>load</sub> = 10 pF to 15pF, C <sub>0, max</sub> = 7 pF, R <sub>m, max</sub> = 50 Ω
SAWFIL	QCC8C	<b>B3555</b> @ RF = 433.6 MHz	B <sub>3dB</sub> = 860 kHz ±100 kHz (f <sub>0</sub> = 433.92 MHz)	low-loss SAW filter from EPCOS
CERFIL	leaded type	SFE10.7MFP @ B <sub>IF2</sub> = 40 kHz	TBD	ceramic filter from Murata
	SMD type	SFECV10.7MJS-A @ B <sub>IF2</sub> = 150 kHz	±40 kHz	
CERRES	SMD type	CDACV10.7MG18-A		ceramic demodulator tank from Murata

NIP – not in place, may be used optionally



ASK Reception

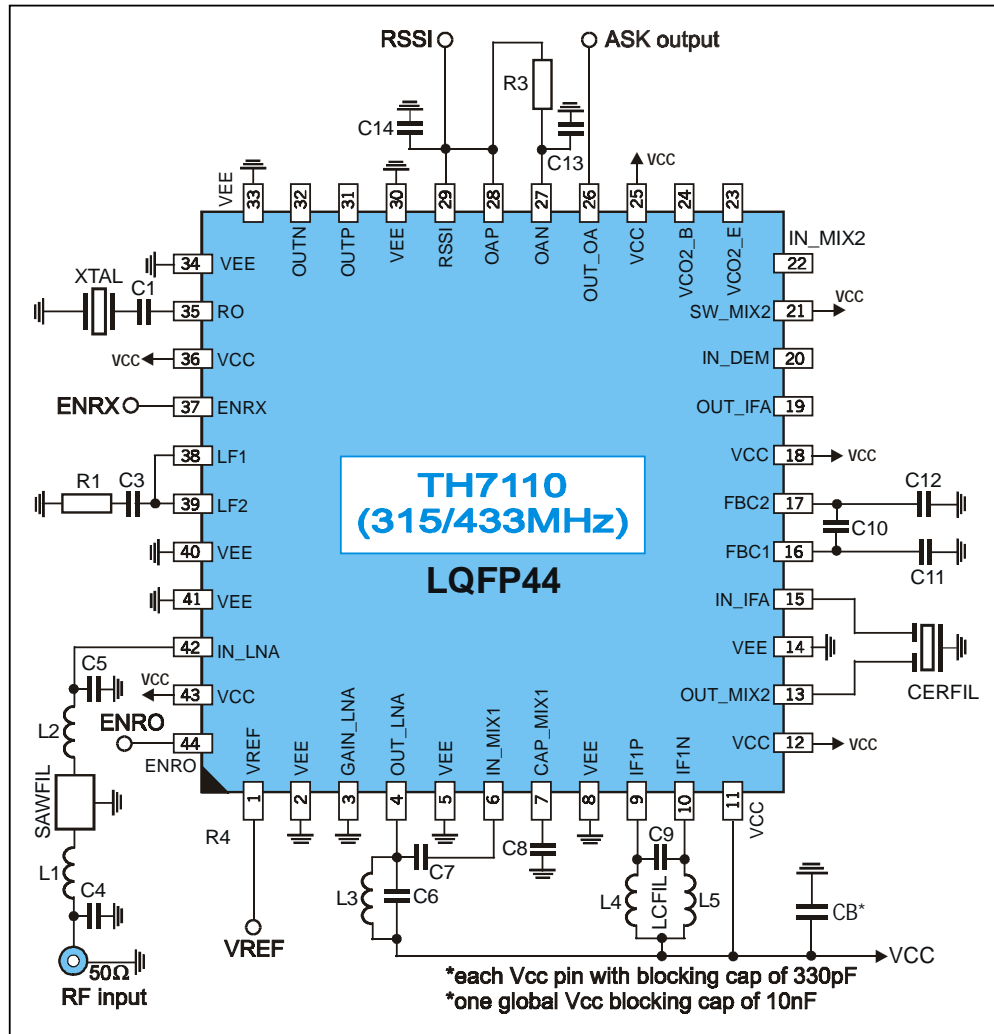

Fig. 5: Test circuit for ASK reception

ASK test circuit component list to Fig. 5

Part	Size	Value / Type	Tolerance	Description
C1	0805	15 pF	±10%	crystal series capacitor
C3	0805	1 nF	±10%	loop filter capacitor
C4	0603	3.3 pF	±5%	capacitor to match to SAW filter input
C5	0603	3.3 pF	±5%	capacitor to match to SAW filter output
C6	0603	4.7 pF	±5%	LNA output tank capacitor
C7	0603	2.2 pF	±5%	MIX1 input matching capacitor
C8	0603	330 pF	±10%	MIX1 blocking capacitor
C9	0805	27 pF	±5%	IF1 tank capacitor
C10	0805	33 nF	±10%	IFA feedback capacitor
C11	0603	1 nF	±10%	IFA feedback capacitor
C12	0603	1 nF	±10%	IFA feedback capacitor
C13	0805	1 nF to 10 nF	±10%	ASK data slicer capacitor, depending on data rate
C14	0603	330 pF	±10%	RSSI output low-pass capacitor
R1	0805	10 kΩ	±10%	loop filter resistor
R3	0603	100 kΩ	±5%	ASK data slicer resistor, depending on data rate
L1	0603	33 nH	±5%	inductor to match SAW filter
L2	0603	33 nH	±5%	inductor to match SAW filter
L3	0603	15 nH	±5%	LNA output tank inductor
L4	0603	100 nH	±5%	IF1 tank inductor
L5	0603	100 nH	±5%	IF1 tank inductor
XTAL	HC49-SMD	<b>23.49444 MHz</b> @ RF = <b>433.6 MHz</b>	±25ppm calibration ±30ppm temp.	fundamental-mode crystal, C <sub>load</sub> = 10 pF to 15pF, C <sub>0, max</sub> = 7 pF, R <sub>m, max</sub> = 50 Ω
SAWFIL	QCC8C	<b>B3555</b> @ RF = <b>433.6 MHz</b>	B <sub>3dB</sub> = 860 kHz ±100 kHz (f <sub>0</sub> = 433.92 MHz)	low-loss SAW filter from EPCOS
CERFIL	leaded type	SFE10.7MFP @ B <sub>IF2</sub> = 40 kHz	TBD	ceramic filter from Murata
	SMD type	SFECV10.7MJS-A @ B <sub>IF2</sub> = 150 kHz	±40 kHz	

NIP – not in place, may be used optionally

Package Dimensions

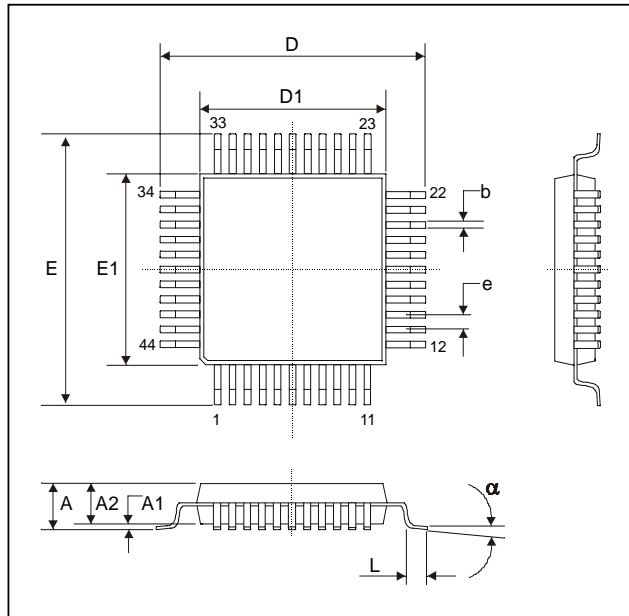

Fig. 6: LQFP44 (Low Quad Flat Package)

All Dimension in mm, coplanarity < 0.1mm									
	E1, D1	A	A1	A2	e	b	L	E, D	α
min	10.00		0.05	1.35	0.8	0.30	0.45	12.00	0°
max		1.60	0.15	1.45		0.45	0.75		7°
All Dimension in inch, coplanarity < 0.004"									
min	0.394		0.002	0.053	0.031	0.012	0.018	0.472	0°
max		0.630	0.006	0.057		0.018	0.030		7°

*Your Notes*

---

### Important Notice

Devices sold by Melexis are covered by the warranty and patent indemnification provisions appearing in its Term of Sale. Melexis makes no warranty, express, statutory, implied, or by description regarding the information set forth herein or regarding the freedom of the described devices from patent infringement. Melexis reserves the right to change specifications and prices at any time and without notice. Therefore, prior to designing this product into a system, it is necessary to check with Melexis for current information. This product is intended for use in normal commercial applications. Applications requiring extended temperature range, unusual environmental requirements, or high reliability applications, such as military, medical life-support or life-sustaining equipment are specifically not recommended without additional processing by Melexis for each application.

The information furnished by Melexis is believed to be correct and accurate. However, Melexis shall not be liable to recipient or any third party for any damages, including but not limited to personal injury, property damage, loss of profits, loss of use, interrupt of business or indirect, special incidental or consequential damages, of any kind, in connection with or arising out of the furnishing, performance or use of the technical data herein. No obligation or liability to recipient or any third party shall arise or flow out of Melexis' rendering of technical or other services.

© 2000 Melexis GmbH. All rights reserved.

---

For the latest version of this document. Go to our website at  
[www.melexis.com](http://www.melexis.com)

Or for additional information contact Melexis Direct:

<b>Europe and Japan:</b>	<b>All other locations:</b>
Phone: +32 1361 1631	Phone: +1 603 223 2362
E-mail: <a href="mailto:sales_europe@melexis.com">sales_europe@melexis.com</a>	E-mail: <a href="mailto:sales_usa@melexis.com">sales_usa@melexis.com</a>

QS9000, VDA6.1 and ISO14001 Certified