

5.5-V, 500-kHz Synchronous Buck Controller Demo Board

DESCRIPTION

This demo board allows users to see how SiP12202 works as a central control unit in a high efficiency, high current DC-to-DC buck converter. It accepts an input voltage of 2.7 V - 5.5 V and outputs 2.5 V.

This board incorporates the SiP12202 buck controller IC, the high-side P-Ch MOSFET Si7106DN and low-side N-Ch MOSFET Si7601DN, the place for an optional 3 A schottky diode, the output L-C filter, input power supply with decoupling capacitors, and required compensation components.

This board can be used as an evaluation vehicle for this SiP12202 buck controller IC.

FEATURES

- SiP12202 demo board includes the required components to evaluate the IC performance in a system
- Easy hook-up to demonstrate system performance using this IC
- 4 layer PCB capable of operating up to 10 A with forced air-cooling

APPLICATIONS

- High current, high efficiency, high frequency DC-DC synchronous buck converters
- Bus converters
- Point of load converter
- Computer, telecoms, set-top boxes

DEMONSTRATION BOARD PHOTO AND HOOK UP

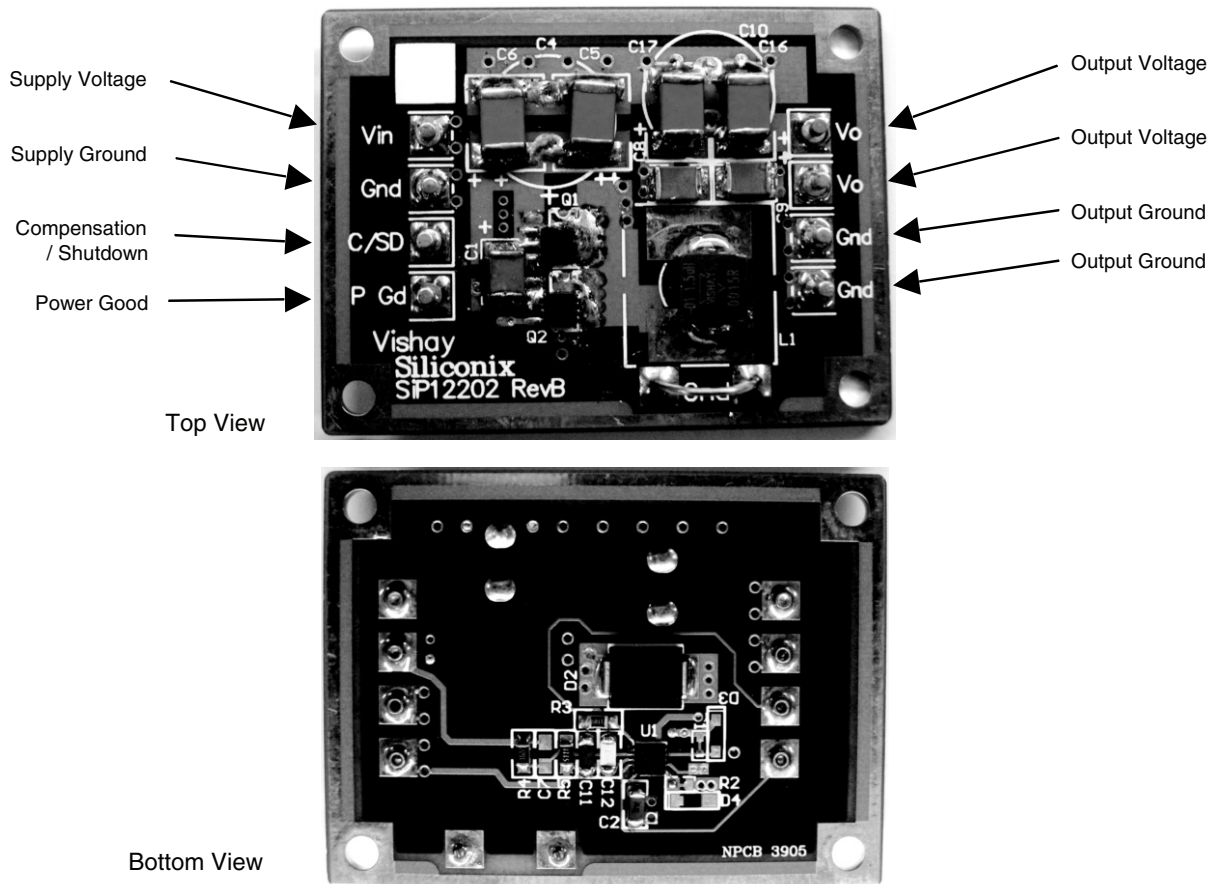

Figure 1.

SCHEMATIC DIAGRAM

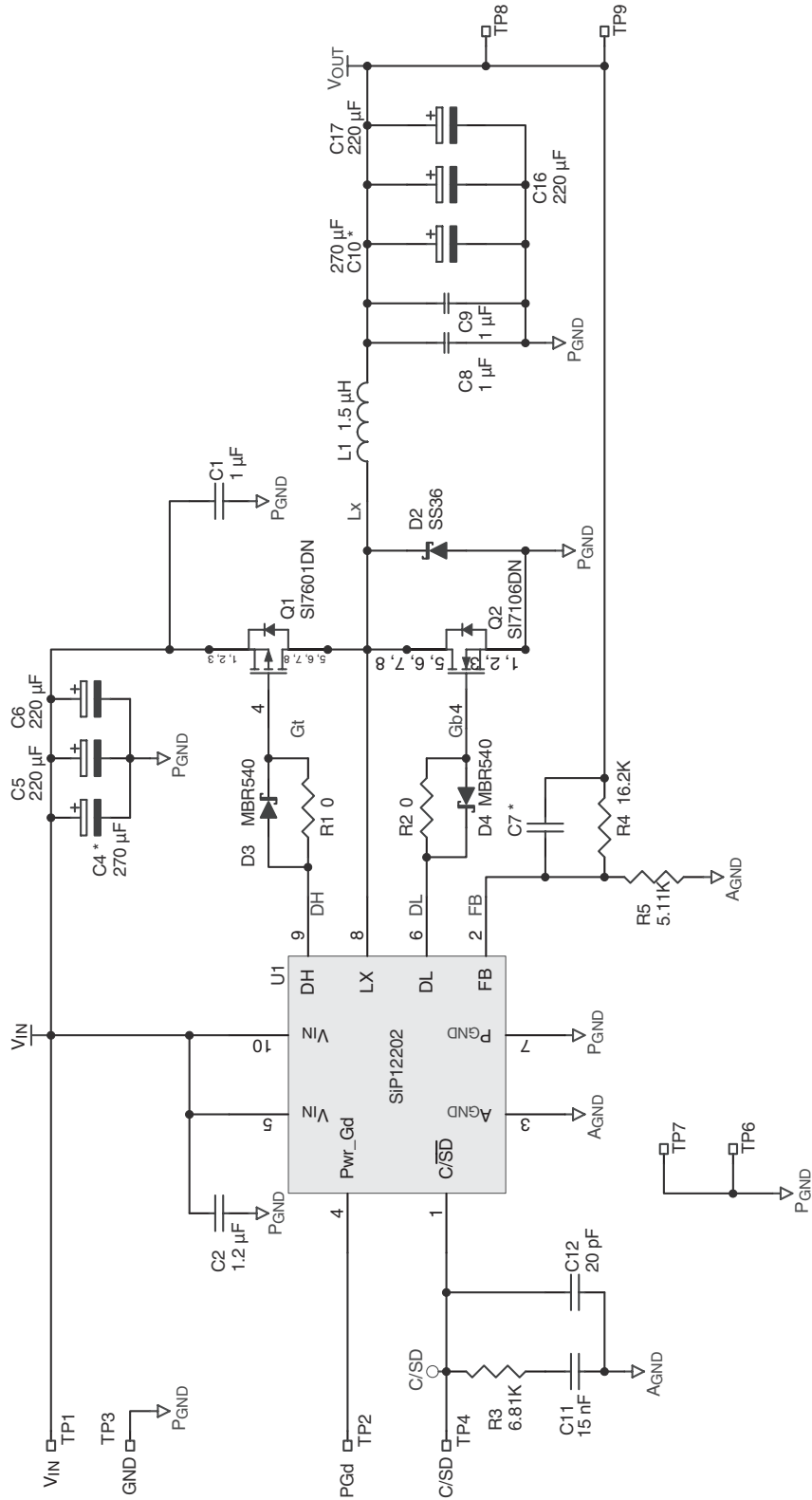

Figure 2.

BILL OF MATERIAL						
Item	Qty	Designator	Part Type	Description	Footprint	Manufacturer
1	1	R3	CRCW08056811RF	Resistor, 1 %, 6.81 k Ω	0805	VISHAY
2	1	R4	CRCW08051622RF	Resistor, 1 %, 16.2 k Ω	0805	VISHAY
3	1	R5	CRCW0805111RF	Resistor, 1 %, 5.11 k Ω	0805	VISHAY
4	2	R1, R2	Not populated. Use trace as 0 Ω	Resistor, 0 Ω		
5	3	C1, C8, C9	VJ1210V105MXAC	Ceramic, 1 μ F, 50 V, 20 %	1210	VISHAY
6	1	C2	VJ1206V105MXXC	Ceramic, 1 μ F, 25 V, 20 %	1206	VISHAY
7	2	C4, C10	Not populated			
8	4	C5, C6, C16, C17	594D227X0010D2T	Tantalum, 220 μ F, 10 V, 20 %	594R	VISHAY
9	1	C7	Not populated			
10	1	C11 C12	VJ0805Y153MXJC VJ0805A200KXAC	Ceramic, 15 nF, 16 V, 20 % Ceramic, 15 nF, 16 V, 20 %	0805 0805	VISHAY VISHAY
11	1	D2	SS36	Schottky diode, 60 V, 3 A	DO-214AB	VISHAY
12	2	D3, D4	Not populated	Diode, MBR540		
13		Q1	Si7601DN	P-Ch MOSFET, 20 V	PowerPAK 1212-8	VISHAY
14	1	Q2	Si7106DN	N-Ch MOSFET, 20 V	PowerPAK 1212-8	VISHAY
15	1	L1	IHLP2525CZER1R5M01	1.5 μ H Power Inductor	IHLP	VISHAY
16	1	U1	SiP12202DM	POWER IC	MLP33-10	VISHAY/SILICONIX

Demo Board Operation

- Connect a 2.7 V to 5.5 V power supply to the “Supply Voltage” and “Supply GND” pins.
- Connect a resistor load or electronic load, which is able to handle minimum 25 W with 2.5 V, to the “Output Voltage” and “Output Ground” pins.
- “Power Good” pin is used for the user to see if the output voltage is in regulated range. An external pull-up resistor is required for this feature to function. An oscilloscope can be used to check this feature.
- If the user wants to shut down the system while it is in operation, an external shutdown signal (lower than 0.15 V, typical) can be connected to the “Compensation/Shutdown” pin. When this signal becomes high, the system will be enabled.

Choice of Components

The purpose of this demo board is to evaluate the SiP12202 IC chip, therefore there are various optional component choices and configurations possible.

The board is designed in such a way that tantalum, ceramic,

electrolytic, OSCON or POSCAP capacitors can be used as the input and output filters (C4, C5, C6, C10, C16, C17), thus allowing the circuit designer to choose different capacitors according to cost / performance constraints. The footprints have been made especially large and versatile to allow for this capability.

The MOSFET footprints are designed in the same way to allow SO-8 and PowerPak SO-8 devices to be used. Of course PowerPAK 1212 package devices can also be used here.

The inductor footprint is designed to allow for a variety of different sizes to be inserted.

A DO-214AB (SMC) footprint is left for D2, the optional 3 A Schottky diode to be populated. If this diode is used it can help reduce switching noise, bypass extra current from MOSFET intrinsic diode, and slightly improve system efficiency. If Si7106DN is used, this diode is required.

The footprint of C7 is included to allow for adding an additional zero in the feedback compensation, for dealing with low ESR output capacitors (such as ceramics).

ORDERING INFORMATION		
Part Number	Marking	Temperature Range
SiP12202DB		- 40 to 85 $^{\circ}$ C

Printed Circuit Board

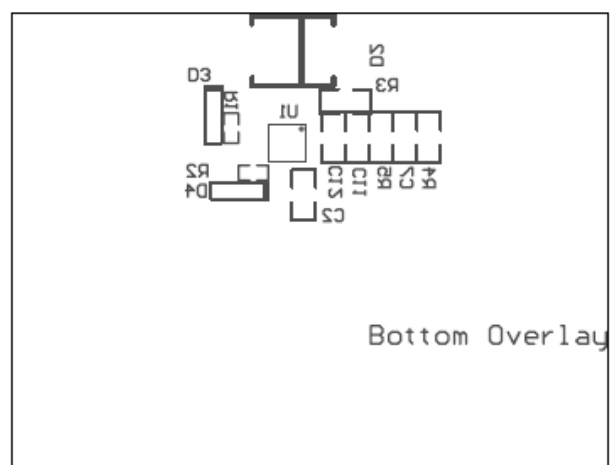
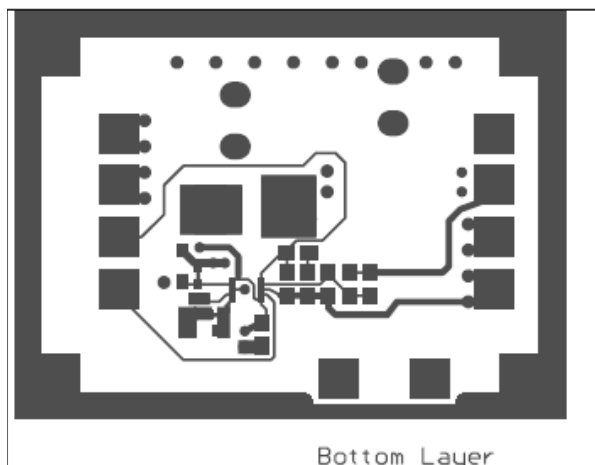
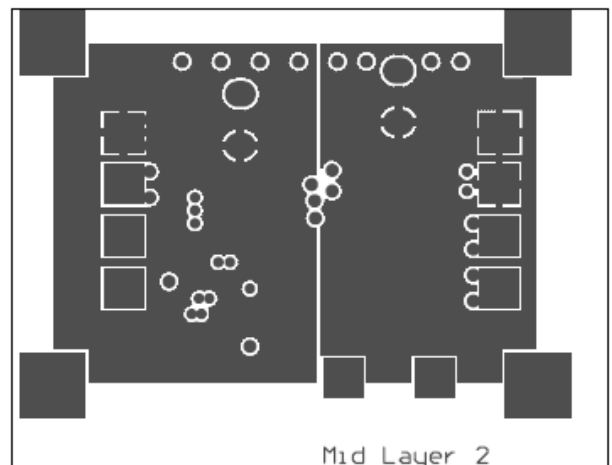
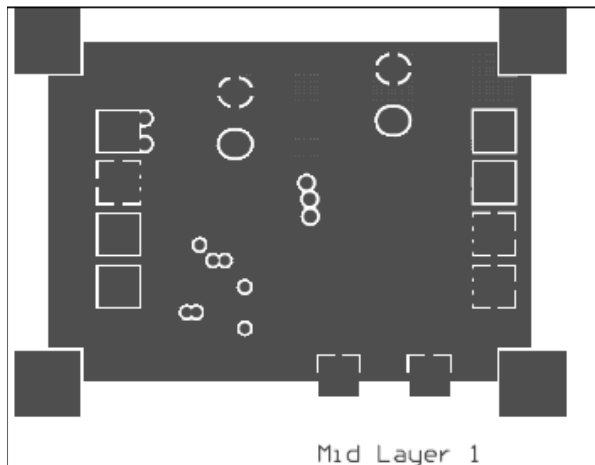
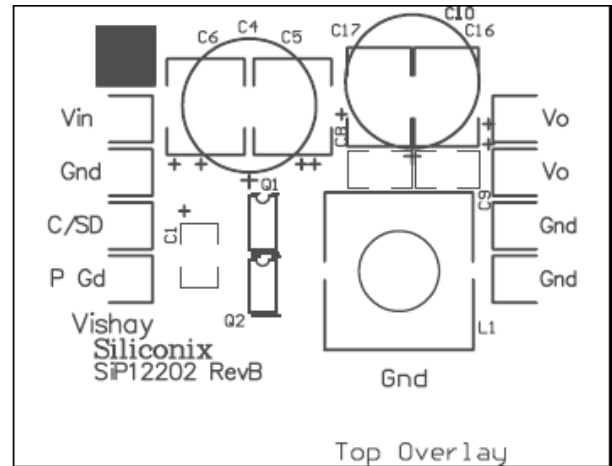
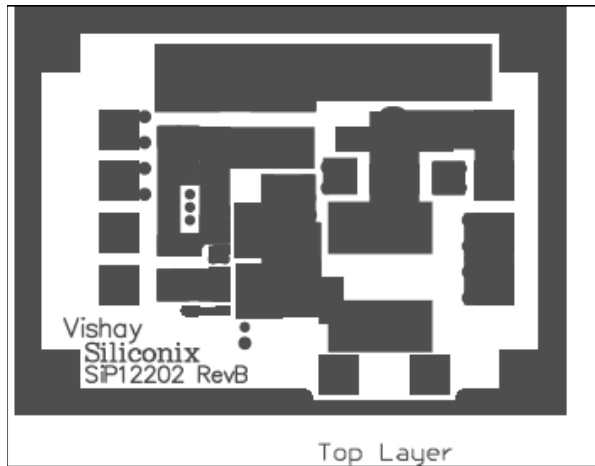

Figure 3.

Vishay Siliconix maintains worldwide manufacturing capability. Products may be manufactured at one of several qualified locations. Reliability data for Silicon Technology and Package Reliability represent a composite of all qualified locations. For related documents such as package/tape drawings, part marking, and reliability data, see <http://www.vishay.com/ppg?68629>.