

STR-E1555

March, 2006

■General Description

STR-E1555 is a Hybrid IC power-factor-corrected switching mode power supply (SMPS). Start-up circuit and a controller of PFC and DC/DC parts are built in one chip. In addition, this chip and Power MOS FET for DC/DC part are incorporated into a SIP package thanks to High Voltage BCD Process technology. STR-E1555 includes the System of Prioritized PFC-Startup for prevention of Start-up Error.

Our proprietary Multi Mode Control system simplifies the design of High Efficiency and Low EMI power supply system with a small number of discrete components.

Additionally, since built-in Auto Standby Function with AC input compensation reduces power consumption at standby, STR-E1555 is optimum for downsizing and standardization of power supply system. STR-E1555 enables to configure the optimum system for diverse PFC outputs because the power MOSFET is provided externally.

■Features

● Integrated PFC Control Block

1. Critical Conduction Mode for High Efficiency and Low EMI
2. Built-in Multiplier with AC input compensation

● High Efficiency and Low EMI DC/DC Control Block

1. Multi Mode Control
 - (1) Quasi Resonant
 - Middle ~ Heavy Load
 - (2) PWM (100kHz) with Frequency Jitter
 - Light ~ Middle Load
 - (3) Low Frequency Operation
 - No Load ~ Extremely Light Load
- PFC <=> DC/DC Part Harmonized Operation System
 1. PFC Priority Start-up System for Prevention of Start-up error
 2. Auto Standby System with AC input compensation
 3. PFC operation stops automatically with delay timer (at standby)

● Protection Functions

1. Over Current Protection with AC input voltage compensation for PFC part (OCP)
2. High Speed Over Voltage Protection for PFC part (OVP) <No latch mode>
3. Over Current Protection for DC/DC part (OCP)
4. Over Load Protection for DC/DC part (OLP)
5. Input Power Limitation System at Intermittent Oscillation
6. Thermal Shut Down (TSD)
7. External Latch Protection by External Signal (ELP)

■Line-up

Part Number	Internal MOSFET	PFC Part (total) Output Power (Included DC/DC Output Power)	DC/DC Part Output Power
STR-E1555	650V / 0.7Ω	200W	200W
STR-E1565	800V / 1.8Ω		80W

■Package---SLA21Pin



Terminal No.	Symbol	Function
1	Startup	Input of startup current for DD and PFC part
2	NC	—
3	PFOut	Output of gate drive signal for MOSFET of PFC part
4	ZCD	Input of zero cross detection signal for PFC
5	CS	Input of drain current sense signal of PFC part
6	PFB/OVP	Input of control signal for constant voltage of PFC part, Input of over voltage protection signal of PFC part, Compensation of input for DD part
7	COMP	Output of Error Amp., phase compensation
8-9	GND	Ground of DD and PFC for control part
10	MultiFP	Input of multiplier for PFC, Input of alteration signal for frequency of DD part, Input of alteration signal of output voltage for DD part, Compensation of AC input for PFC, Input of latch signal for DD and PFC part
11	DLP	PFC OFF delay time adjust
12	BD	Input of bottom on detection of DD part
13	OCP	Input of over current detection signal of DD part
14	DFB	Input of control signal for constant voltage of DD part
15	Vcc	Input of power supply of DD and PFC for control part
16	DDout	Output of gate drive signal for MOSFET of DD part(pin cut)
17	Source	MOSFET Source for DD part
18-19	NC	—
20-21	Drain	MOSFET Drain for DD part

■Applications

- LCD-TV
- LCD-Monitor
- Projection-TV
- AC Adapter

*Electrical equipment requiring the measures against higher harmonics.

STR-E1555

Typical Connection

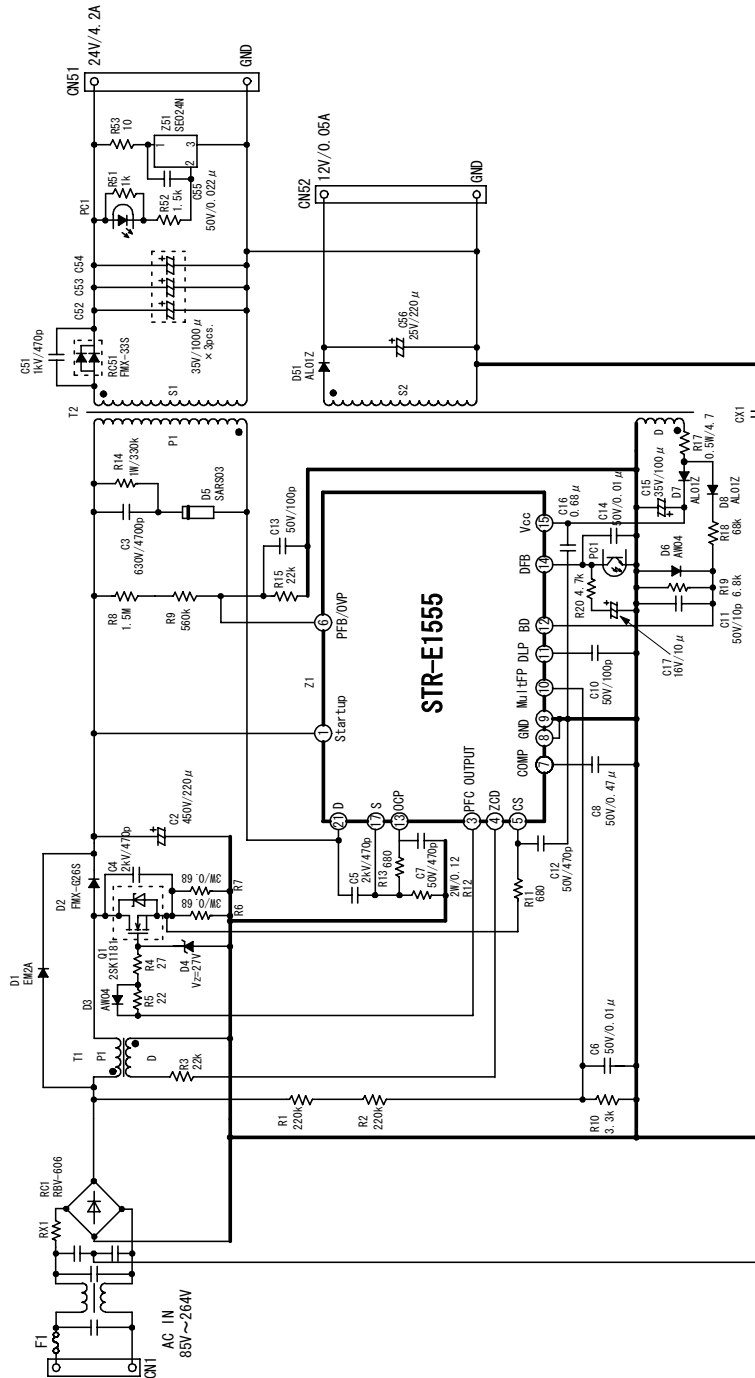

Key Specifications

1 Absolute Maximum Ratings (Ta=25°C)

Parameter	Terminal	Symbol	Ratings	Unit	Note
Drain current	21-17	IDpeak ^{*1}	10	A	Single Pulse
Maximum switching current	21-17	IDMAX ^{*5}	9.2	A	Ta=-20 to +125°C
Single pulse avalanche energy	21-17	EAS ^{*2}	222	mJ	Single Pulse
					VDD=30V,L=10mH IL peak=5.4A
Input voltage for control part	15-9	Vcc	30	V	
MultFP terminal input current	10-9	ImultFp	10	mA	
Startup terminal voltage	1-9	Vstartup	-0.3 to 600	V	
CS terminal voltage	5-9	Vcs	-0.5 to +10	V	
PFB/OVP terminal voltage	6-9	VPFB/OVP	-0.5 to +7	V	
PFB/OVP terminal input current		IPFB/OVP	5	mA	
ZCD terminal input current	4-9	IZCD(I)	5	mA	
ZCD terminal output current		IZCD(O)	-5		
PFCout terminal source current	3-9	IoPFC(source)	300	mA	
PFCout terminal sink current	3-9	IoPFC(sink)	500	mA	
DFB terminal input voltage	14-9	VDFB	-0.5 to +15	V	
DFB terminal output current		IDFB	2.2	mA	
OCF terminal input voltage	13-9	VOCP	-0.5 to +7	V	
BD terminal input voltage	12-9	VBD	-0.5 to +7	V	
Power dissipation for MOSFET	-	PD1 ^{*3}	9.6	W	With infinite heatsink
			1.8		Without heatsink
Power dissipation for control part(MIC)	-	PD2 ^{*4}	1.1	W	
Operating ambient temperature	-	Top	-20 to +125	°C	
Storage temperature	-	Tstg	-40 to +125	°C	
Channel temperature	-	Tch	+150	°C	

*1 Refer to MOS FET A.S.O characteristic

*3 Refer to MOS FET Ta-PD1 characteristic

*5 Maximum switching current

*2 Refer to MOS Tch-EAS characteristic

*4 Refer to MIC TF-PD2 characteristic

The maximum switching current is the Drain current determined by the drive voltage of the IC and threshold voltage (Vth) of MOS FET.

Therefore, in the event that voltage drop occurs between No.17 and No.9 terminals due to patterning, the maximum switching current decreases as shown by V17-9 in Fig.1

Accordingly please use this device within the decrease value, referring to the derating curve of the maximum switching current.

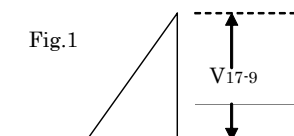

STR-E1555

March, 2006

2 Electrical Characteristics

2-1 Electrical Characteristics for Control Part (Vcc=20V, Ta=25°C unless otherwise specified)

2-1-1 Total device part

Parameter	Terminal	Symbol	Rating			Unit
			MIN	TYP	MAX	
Operation start voltage	15-9	Vcc(ON)	14.5	16.0	17.5	V
Operation stop voltage	15-9	Vcc(OFF)	9.0	9.7	10.5	V
Circuit current in operation	15-9	Icc(ON)	-	-	22	mA
Circuit current in non-operation	15-9	Icc(OFF)	-	-	350	μA
Latch circuit release voltage*6	15-9	Vcc(La.off)	6.5	7.2	7.9	V
Input voltage in latch circuit operated*6	15-9	Vcc(La.on)	8.4	9.6	11.5	V
Latch circuit sustaining current*6	15-9	IH	-	500	1200	μA
Startup circuit	1-9	Istartup	3.4	5.4	7.7	mA
Bias current at startup terminal when startup circuit	1-9	Istartup(off)	-	20	80	μA
Latch threshold voltage of MultFP terminal	10-9	Vmult(La)	6.5	7.2	8.0	V
Restart power supply voltage	15-9	Vcc(RS)	7.0	7.8	8.6	V
Auto bias voltage	15-9	Vcc(BIAS)	10.1	11.0	11.8	V
Vcc(RS) - Vcc(La.off)	-	-	0.3	0.6	-	V
Vcc(OFF) - Vmult(La)	-	-	1.7	2.5	-	V
Thermal shutdown operating temperature	-	TSD	135	150	-	°C

*6 The latch circuit means a circuit operated an external signal over Latch threshold voltage of MultFP terminal.

2-1-2 PFC part

Parameter	Terminal	Symbol	Rating			Unit
			MIN	TYP	MAX	
PFB/OVP terminal threshold voltage(Hi)	6-9	VPFB(Hi)	3.905	4.000	4.056	V
PFB/OVP terminal input bias current	6-9	IPFB(B)	-5	-2	-	μA
COMP terminal source current	7-9	Icomp(SOU)	5	11	16	μA
COMP terminal sink current	7-9	Icomp(SIN)	-16	-11	-5	μA
COMP terminal Hi voltage	7-9	Vcomp(H)	5.8	6.4	-	V
COMP terminal Lo voltage	7-9	Vcomp(Hgl)	-	1.6	1.9	V
Over voltage detective input threshold voltage	6-9	VPFB(th)	4.14	4.27	4.40	V
MultFP terminal input bias current	10-9	Imult(B)	-10	-1	-	μA
Multiplier Gain	-	K	0.4	0.6	0.8	-
Zero Current Detective threshold voltage	4-9	VZCD(th)	1.4	1.6	1.8	V
Zero Current Detective hysteresis	4-9	VZCD(HIS)	150	190	260	mV
Zero Current Detective Hi clamp voltage	4-9	VZCD(HC)	6.0	6.6	7.0	V
Zero Current Detective Lo clamp voltage	4-9	VZCD(LC)	0.53	0.63	0.77	V

STR-E1555

March, 2006

Restart delay time	-	tDLY	150	520	-	μs
CS terminal input bias current	5-9	ICS (B)	-8.0	-1	-	μA
CS terminal input offset voltage	5-9	VCS (IOS)	-	16.9	25.0	mV
Maximum current sense input threshold	5-9	VCSMAX	1.18	1.37	1.52	V
Maximum current sense input threshold	5-9	VCSMAX	0.60	0.66	0.73	V
PFB/OVP terminal threshold voltage for DD Operation start signal	6-9	VPFB (DD ON)	2.9	3.2	3.5	V
PFCout terminal output voltage	3-9	VPFC OUT	10.2	11.8	-	V
Operation Voltage at UVLO	3-9	VPFCOUTUVLO	0.9	1.3	1.6	V

2-1-3 DD Part

Parameter	Terminal	Symbol	Rating			Unit
			MIN	TYP	MAX	
Oscillation frequency (1)	16-9	fosc(1)	91	100	109	kHz
Oscillation frequency (2)	16-9	fosc(2)	76	83	90	kHz
Maximum ON time(1)	16-9	T _{ON} (MAX1)	7.4	8.8	9.7	μs
Maximum ON time(2)	16-9	T _{ON} (MAX2)	9.0	10.7	11.7	μs
Bottom detective terminal input threshold voltage	12-9	VBD (th)	0.67	0.76	0.84	V
Bottom detective terminal input bias current	12-9	I BD (B)	-6	-3	-	μA
OCP terminal detective voltage(1)	13-9	VOCP(1)	0.70	0.76	0.82	V
OCP terminal detective voltage(2)	13-9	VOCP(2)	0.54	0.60	0.66	V
OCP terminal input bias current	13-9	IOCP(B)	-12	-6	-	μA
Standby operation start on-time	16-9	TON (STB IN)	290	350	410	ns
Minimum on-time in Standby operation (1)	16-9	TON(STBMIN	460	580	700	ns
Minimum on-time in Standby operation (2)	16-9	TON(STBMIN	0.8	1.2	1.6	μs
Standby operation Release on-time(1)	16-9	TON(STBout1)	1.61	1.96	2.31	μs
Standby operation Release on-time(2)	16-9	TON(STBout2)	2.58	3.18	3.78	μs
Standby detective voltage at input compensation	6-9	VPFB(STB)	1.8	2.4	3.0	V
DLP terminal constant current L	11-9	IDLPL	-	1	4	μA
DLP terminal constant current H	11-9	IDLPH	20	40	60	μA
DLP terminal threshold voltage L for	11-9	VDLPL	0.7	0.9	1.1	V
DLP terminal threshold voltage H for	11-9	VDLPH	4.1	4.6	5.1	V
DFB terminal constant current	14-9	ICONST	15	21	27	μA
OLP terminal threshold voltage	14-9	VOLP	5.9	6.5	7.3	V
DD out terminal output voltage	16-9	VDDOUT	11.7	12.5	-	V

STR-E1555

March, 2006

2-2 Electrical characteristics for MOSFET(Ta=25°C)

Parameter	Terminal	Symbol	Rating			Unit
			MIN	TYP	MAX	
Drain-to-Source breakdown voltage	21-17	VDSS	650	-	-	V
Drain leakage current	21-17	IDSS	-	-	300	μA
On-resistance	21-17	RDS(ON)	-	-	0.7	Ω
Switching time	21-17	tf	-	-	450	ns
Thermal resistance *	-	θch-F	-	-	1.7	°C/W

*Between channel and internal frame

STR-E1555
Fig2 A.S.O. temperature derating coefficient characteristic

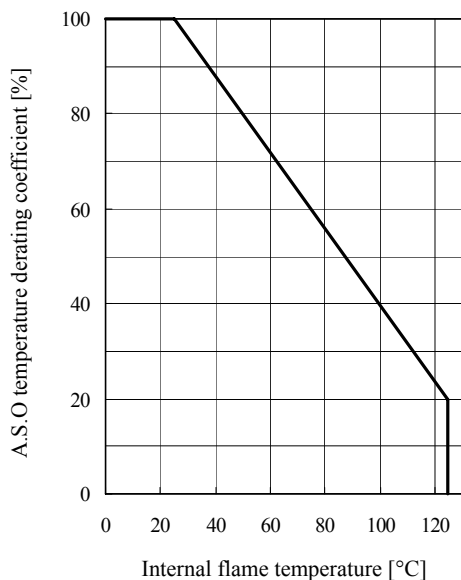

STR-E1555
Fig3 MOSFET A.S.O. characteristic (Ta=25°C/single pulse)

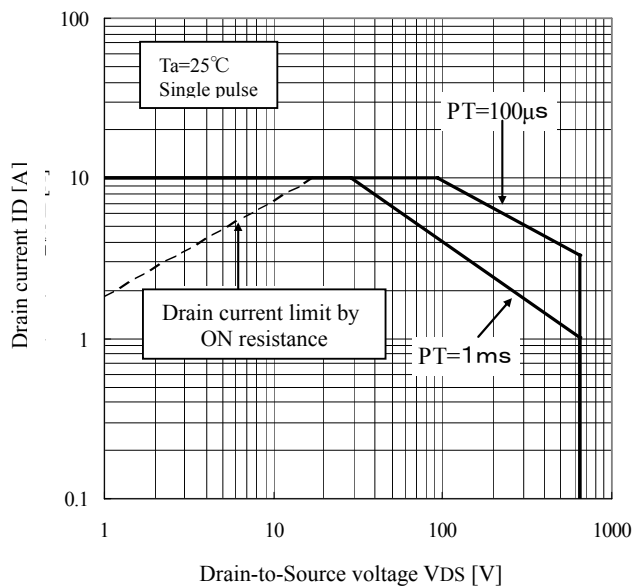

STR-E1555

March, 2006

STR-E1555
Fig4 Maximum switching current derating characteristic

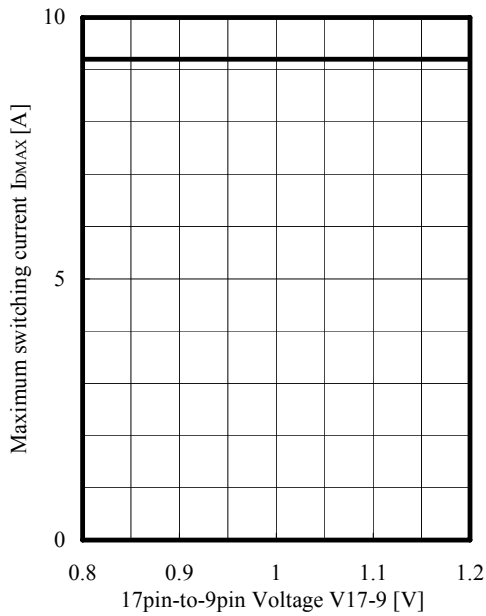

STR-E1555
Fig5 Avalanche energy derating characteristic

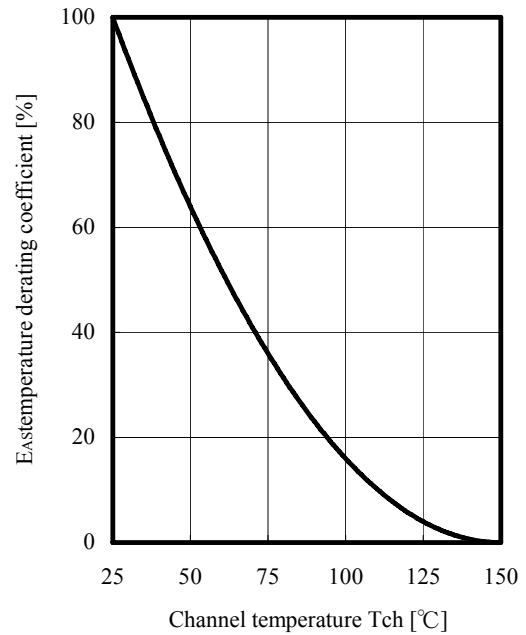

STR-E1555
Fig6 MOSFET Ta-PD1 characteristic

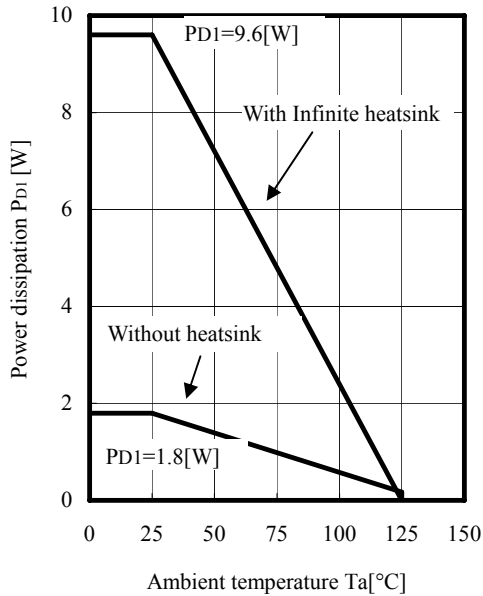

3
2
1

STR-E1555

March, 2006

STR-E1555
Fig8 MOSFET Transient thermal resistance characteristic

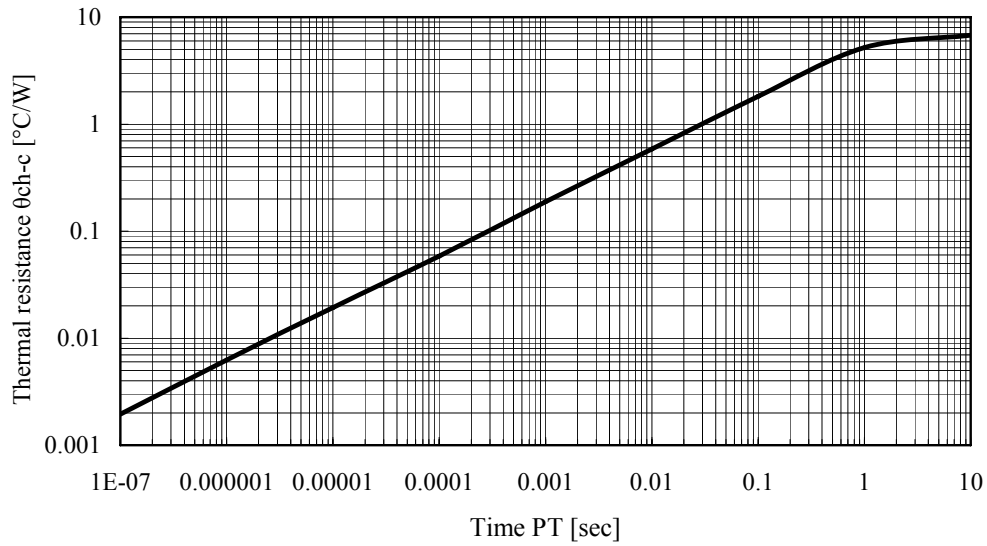

STR-E1555

March, 2006

Package information

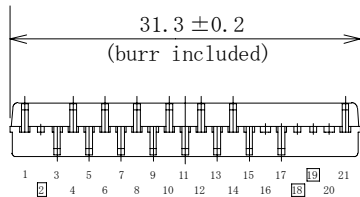
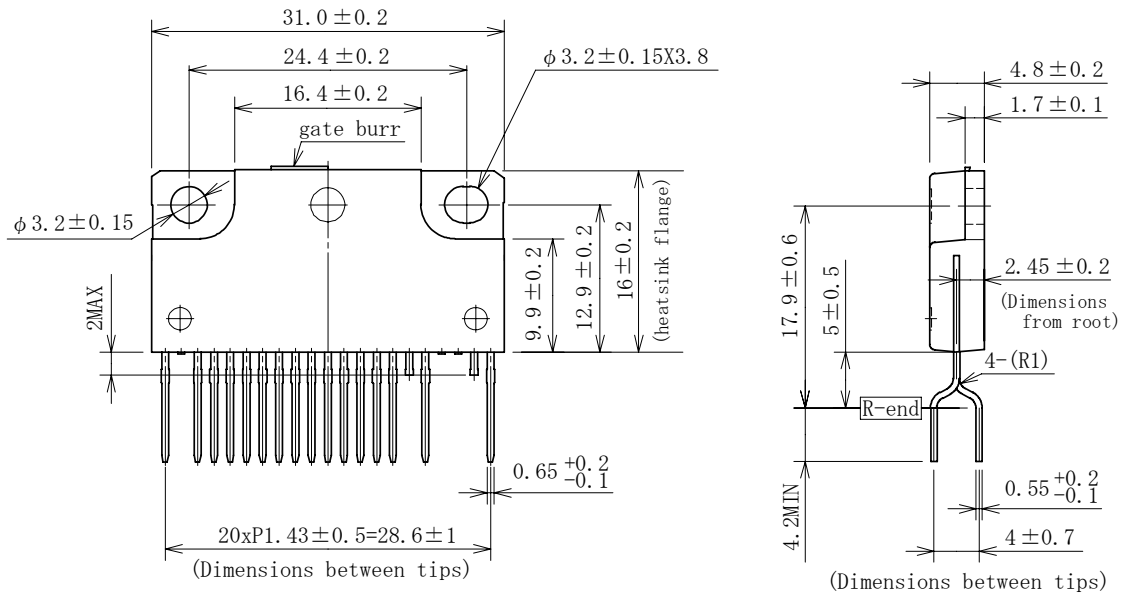

2 18 19 pins are removed.

- Material of terminal: Cu
- Treatment of terminal: Ni plating + Solder dip (Pb free)
- Mass: Approx 5.6g

Dimensions: mm

STR-E1555

March, 2006



CAUTION / WARNING

Since reliability can be affected adversely by improper storage environment and handling methods during Characteristic tests, please observe the following cautions.

Cautions for Storage

- Ensure that storage conditions comply with the standard temperature (5 to 35°C) and the standard relative humidity (around 40 to 75%) and avoid storage locations that experience extreme changes in temperature or humidity.
- Avoid locations where dust or harmful gases are present and avoid direct sunlight.
- Reinspect for rust in leads and solderability that have been stored for a long time.

Cautions for characteristic Tests and Handling

When characteristic tests are carried out during inspection testing and other standard tests periods, protect the devices from surge of power from the testing device, shorts between the devices and the heatsink.

Remarks in using silicone grease for a heatsink

When silicone grease is used in mounting this product on a heatsink, it shall be applied evenly and thinly. If more silicone grease than required is applied, it may produce forced stress.

Volatile type silicone grease may produce cracks after elapse of long term, resulting in reducing heat radiation effect. Silicone grease with low consistency (hard grease) may cause cracks in the mold resin when screwing the product to a heatsink.

Recommended operating temperature

Inner frame temperature in operation $T_F=105(^{\circ}\text{C})\text{MAX.}$

Recommended Screw Torque

0.588 to 0.785[N•m] (6 to 8[kgf•cm])

Soldering Temperature

When soldering the products, please be sure to minimize the working time, within the following conditions.

- 260±5°C 10sec.
- 350±5°C 3sec. (Soldering iron)

Considerations to protect the Products from Electrostatic Discharge

- When handling the devices, operator must be grounded. Grounded wrist straps be worn and should have at least 1MΩ of resistance near operators to ground to prevent shock hazard.
- Workbenches where the devices are handled should be grounded and be provided with conductive table and floor mats.
- When using measuring equipment such as a curve tracer, the equipment should also be grounded.
- When soldering the devices, the head of a soldering iron or a solder bath must be grounded in other to prevent leak voltage generated by them from being applied to the devices.
- The devices should always be stored and transported in our shipping containers or conductive containers, or be wrapped up in aluminum foil.

<Worldwide Contacts>

Asia Pacific

China

Sanken Electric Hong Kong Co., Ltd.

Suite 1026 Ocean Centre, Canton Road, Tsimshatsui, Kowloon, Hong Kong

Tel: 852-2735-5262

Fax: 852-2735-5494

Sanken Electric (Shanghai) Co., Ltd.

Room3202, Maxdo Centre, Xingyi Road 8, Changning district, Shanghai, China

Tel: 86-21-5208-1177

Fax: 86-21-5208-1757

Taiwan Sanken Electric Co., Ltd.

Room 1801, 18th Floor, 88 Jung Shiau East Road, Sec. 2, Taipei 100, Taiwan R.O.C.

Tel: 886-2-2356-8161

Fax: 886-2-2356-8261

India

Saket Devices Pvt. Ltd.

Office No.13, First Floor, Bandal - Dhankude Plaza, Near PMT Depot, Paud Road, Kothrud, Pune - 411 038, India

Tel: 91-20-5621-2340

91-20-2528-5449

Fax: 91-20-2528-5459

Japan

Sanken Electric Co., Ltd. Overseas Sales Headquarters

Metropolitan Plaza Bldg. 1-11-1 Nishi-Ikebukuro, Toshima-ku, Tokyo 171-0021, Japan

Tel: 81-3-3986-6164

Fax: 81-3-3986-8637

Korea

Sanken Electric Korea Co., Ltd.

Mirae Asset Life Bldg. 6F, 168 Kongduk-dong, Mapo-ku, Seoul, 121-705, Korea

Tel: 82-2-714-3700

Fax: 82-2-3272-2145

Singapore

Sanken Electric Singapore Pte. Ltd.

150 Beach Road, #14-03 The Gateway West, Singapore 189720

Tel: 65-6291-4755

Fax: 65-6297-1744

STR-E1555

March, 2006

Europe

United Kingdom

Sanken Power Systems (UK) Limited

Pencoed Technology Park, Pencoed, Bridgend CF35 5HY. UK

Tel: 44-1656-869-100

Fax: 44-1656-869-162

North America

United States

Allegro MicroSystems, Inc.

115 Northeast Cutoff, Worcester, Massachusetts 01606, U.S.A.

Tel: 1-508-853-5000

Fax: 1-508-853-3353

Allegro MicroSystems, Inc. (Southern California)

14 Hughes Street, Suite B105, Irvine, CA 92618

Tel: 1-949-460-2003

Fax: 1-949-460-7837

CAUTION / WARNING

- The information in this publication has been carefully checked and is believed to be accurate; however, no responsibility is assumed for inaccuracies.
 - Sanken reserves the right to make changes without further notice to any products herein in the interest of improvements in the performance, reliability, or manufacturability of its products.
Before placing an order, Sanken advises its customers to obtain the latest version of the relevant information to verify that the information being relied upon is current.
 - Application and operation examples described in this catalog are quoted for the sole purpose of reference for the use of the products herein and Sanken can assume no responsibility for any infringement of industrial property rights, intellectual property rights or any other rights of Sanken or any third party which may result from its use.
 - When using the products herein, the applicability and suitability of such products for the intended purpose or object shall be reviewed at the users' responsibility.
 - Although Sanken undertakes to enhance the quality and reliability of its products, the occurrence of failure and defect of semiconductor products at a certain rate is inevitable. Users of Sanken products are requested to take, at their own risk, preventative measures including safety design of the equipment or systems against any possible injury, death, fires or damages to the society due to device failure or malfunction.
 - Sanken products listed in this catalog are designed and intended for the use as components in general purpose electronic equipment or apparatus (home appliances, office equipment, telecommunication equipment, measuring equipment, etc.). Before placing an order, the user's written consent to the specifications is requested.
When considering the use of Sanken products in the applications where higher reliability is required (transportation equipment and its control systems, traffic signal control systems or equipment, fire/crime alarm systems, various safety devices, etc.), please contact your nearest Sanken sales representative to discuss and obtain written confirmation of your specifications. The use of Sanken products without the written consent of Sanken in the applications where extremely high reliability is required (aerospace equipment, nuclear power control systems, life support systems, etc.) is strictly prohibited.
 - Anti radioactive ray design is not considered for the products listed herein.
 - This publication shall not be reproduced in whole or in part without prior written approval from Sanken.
-
- This is notification that you, as purchaser of the products/technology, are not allowed to perform any of the following:
 1. Resell or retransfer these products/technology to any party intending to disturb international peace and security.
 2. Use these products/technology yourself for activities disturbing international peace and security.
 3. Allow any other party to use these products/technology for activities disturbing international peace and security.Also, as purchaser of these products/technology, you agree to follow the procedures for the export or transfer of these products/technology, under the Foreign Exchange and Foreign Trade Law, when you export or transfer the products/technology abroad.