

FEATURES

- True Color PWM™ with 3000:1 Dimming Ratio
- Operates in Boost, Buck Mode or Buck-Boost Mode
- Wide Input Voltage Range:
 - Operation from 3V to 30V
 - Transient Protection to 40V
- Gate Driver for Optional PWM Dimming with P-channel MOSFET
- Adjustable Frequency: 250kHz to 2MHz
- Constant-Current and Constant-Voltage Regulation
- Low Shutdown Current: <1µA
- RoHS Compliant Package with Gold Pad Finish
- Tiny, Low Profile (9mm × 15mm × 2.82mm) Surface Mount LGA Package

APPLICATIONS

- Display Backlighting
- Automotive and Avionic Lighting
- Illumination
- Scanners

LT, LT, LTC, LTM, Linear Technology, the Linear logo and µModule are registered trademarks and True Color PWM is a trademark of Linear Technology Corporation. All other trademarks are the property of their respective owners.

DESCRIPTION

The LTM®8042 is a complete µModule® Boost LED Driver specifically designed to drive LEDs up to 1A, while the LTM8042-1 drives up to 350mA. It combines a boost power topology with a unique current loop to operate as a constant-current source. The PWM input provides as much as 3000:1 LED dimming, while 10:1 analog dimming can be accomplished by a single resistor or analog voltage applied to the CTL pin. As with any boost topology, the LTM8042/LTM8042-1 has an uninterrupted current path between its input and output and is thus intolerant to a short-circuit or overload from the output to ground.

# WHITE LEDs	LED CURRENT	12V _{IN}	24V _{IN}
6	1A	LTM8042	
7	350mA	LTM8042-1	
8	1A		LTM8042
9	350mA		LTM8042-1

The LTM8042/LTM8042-1 is packaged in a thermally enhanced, compact overmolded land grid array (LGA) package. The LTM8042/LTM8042-1 is Pb-free and a RoHS compliant.

TYPICAL APPLICATION

µModule Boost LED Driver, Driving 8 White LEDs at 1A

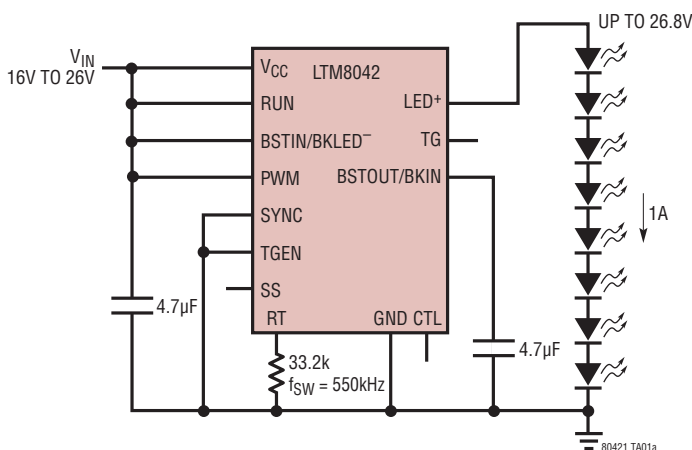

Efficiency vs V_{IN}

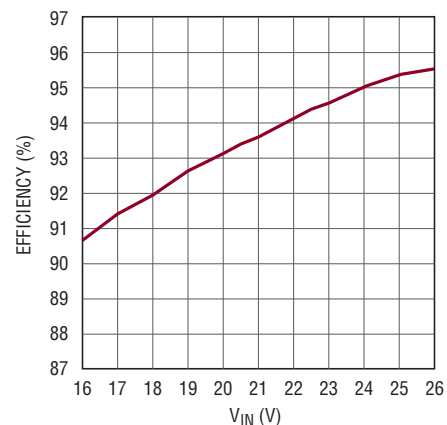

LTM8042/LTM8042-1

ABSOLUTE MAXIMUM RATINGS

(Note 1)

V_{CC} , RUN, PWM, TGEN, BSTIN/BKLED ⁻	40V
BSTOUT/BKIN, TG, LED ⁺	43V
TG Pin Below LED ⁺	10V
CTL, SYNC, SS	6V
RT	3V
Internal Operating Temperature (Notes 3, 4)	-40°C to 125°C
Solder Temperature	245°C
Storage Temperature	-55°C to 125°C

PIN CONFIGURATION

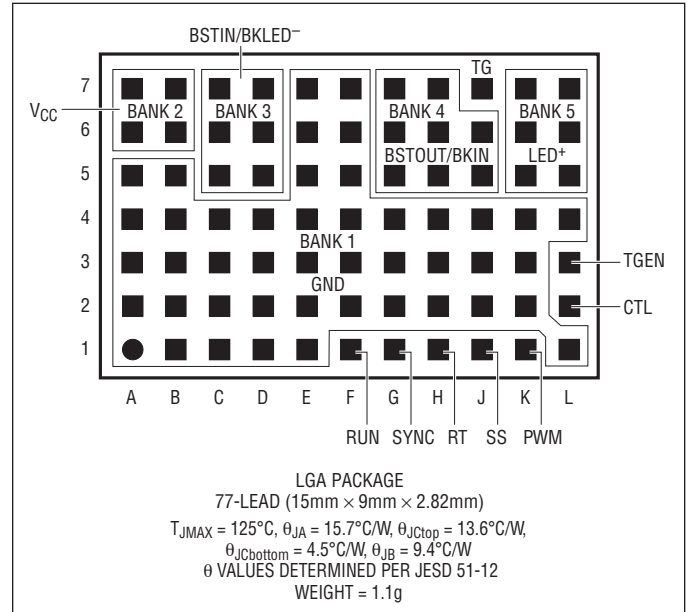

ORDER INFORMATION

LEAD FREE FINISH	TRAY	PART MARKING*	PACKAGE DESCRIPTION	TEMPERATURE RANGE
LTM8042EV#PBF	LTM8042EV#PBF	LTM8042V	77-Lead (15mm × 9mm × 2.82mm) LGA	-40°C to 125°C
LTM8042IV#PBF	LTM8042IV#PBF	LTM8042V	77-Lead (15mm × 9mm × 2.82mm) LGA	-40°C to 125°C
LTM8042EV-1#PBF	LTM8042EV-1#PBF	LTM8042-1V	77-Lead (15mm × 9mm × 2.82mm) LGA	-40°C to 125°C
LTM8042IV-1#PBF	LTM8042IV-1#PBF	LTM8042-1V	77-Lead (15mm × 9mm × 2.82mm) LGA	-40°C to 125°C

Consult LTC Marketing for parts specified with wider operating temperature ranges. *The temperature grade is identified by a label on the shipping container.

For more information on lead free part marking, go to: <http://www.linear.com/leadfree/>

This product is only offered in trays. For more information go to: <http://www.linear.com/packaging/>

ELECTRICAL CHARACTERISTICS

The ● denotes the specifications which apply over the full internal operating temperature range, otherwise specifications are at $T_A = 25^\circ\text{C}$. $V_{CC} = 5\text{V}$, buck mode with 4Ω load.

SYMBOL	PARAMETER	CONDITIONS	MIN	TYP	MAX	UNITS
$V_{CC(MIN)}$	Minimum Input DC Voltage		● 3			V
I_{LED}	LTM8042 LED Current	CTL Open	0.9		1.05	A
		CTL Open, $R_{CTL} = 6.81\text{k}$	0.45	0.5	0.55	A
	LTM8042-1 LED Current		0.34		0.39	A
		$R_{CTL} = 6.81\text{k}$	0.17		0.20	A
V_{CLAMP}	Open LED Clamp Voltage	Boost Mode, LED ⁺ Open		36		V
$\Delta I_{OUT}/I_{OUT}$	Output Current Line Regulation	LTM8042, $6\text{V} < \text{BSTOUT}/\text{BKIN} < 30\text{V}$		0.5		%
		LTM8042-1, $6\text{V} < \text{BSTOUT}/\text{BKIN} < 30\text{V}$		0.5		%
I_{QVCC}	V_{CC} Supply Current	PWM = 0V		4.2		mA
		RUN = 0V		0.1	1	μA
f_{SW}	Switching Frequency	RT = 90.9k	0.22	0.25	0.27	MHz
		RT = 22.1k	0.68	0.8	0.92	MHz
		RT = 6.04k	1.7	2	2.3	MHz
I_{SS}	Soft-Start Pin Current	SS = 0.5V, Out of Pin	6	9	12	μA
f_{SYNC}	Synchronization Frequency Range		0.3		2.5	MHz
I_{SYNC}	SYNC Pull-Down Current (Into the Pin)	$V_{SYNC} = 2\text{V}$		60		μA
$V_{SYNC(IL)}$	SYNC Input Low				0.4	V
$V_{SYNC(IH)}$	SYNC Input High		1.5			V
I_{CTL}	CTL Input Bias Current	CTL = 0V, Flows Out of Pin		100		μA
$V_{RUN(IH)}$	RUN Input Voltage High		1.5			V
$V_{RUN(IL)}$	RUN Input Voltage Low				0.4	V
I_{RUN}	RUN Pin Bias Current			60	100	μA
$V_{PWM(IH)}$	PWM Input Voltage High		1.5			V
$V_{PWM(IL)}$	PWM Input Voltage Low				0.4	V
I_{PWM}	PWM Pin Bias Current			60	120	μA
$V_{TG(OH)}$	TG Output High Voltage	Relative to LED ⁺ , 100k from LED ⁺ to TG		0		V
$V_{TG(OL)}$	TG Output Low Voltage	Relative to LED ⁺ , 100k from LED ⁺ to TG		-7		V
$V_{TGEN(IH)}$	TGEN Input Voltage High	PWM = 0V	1.5			V
$V_{TGEN(IL)}$	TGEN Input Voltage Low				0.4	V
I_{TGEN}	TGEN Pin Bias Current			100	200	μA

Note 1: Stresses beyond those listed under Absolute Maximum Ratings may cause permanent damage to the device. Exposure to any Absolute Maximum Rating condition for extended periods may affect device reliability and lifetime.

Note 2: Absolute maximum voltage at V_{CC} , RUN, PWM, TGEN, BSTIN/BKLED⁻ pins is 40V for non-repetitive one second transients and 30V for continuous operation.

Note 3: The LTM8042E/LTM8042E-1 are guaranteed to meet performance specifications from 0°C to 125°C ambient. Specifications over the full -40°C to 125°C internal operating temperature range are assured by design, characterization and correlation with statistical process controls.

The LTM8042I/LTM8042I-1 are guaranteed to meet specifications over the full -40°C to 125°C internal operating temperature range. Note that the maximum internal temperature is determined by specific operating conditions in conjunction with board layout, the rated package thermal resistance and other environmental factors.

Note 4: This device includes overtemperature protection that is intended to protect the device during momentary overload conditions. Junction temperature will exceed the maximum internal operating temperature when overtemperature protection is active. Continuous operation above the specified maximum operating junction temperature may impair device reliability.

TYPICAL PERFORMANCE CHARACTERISTICS $T_A = 25^\circ\text{C}$, unless otherwise noted.

LTM8042

Efficiency vs V_{IN} , Boost Operation, 6.8V at 1A LED String

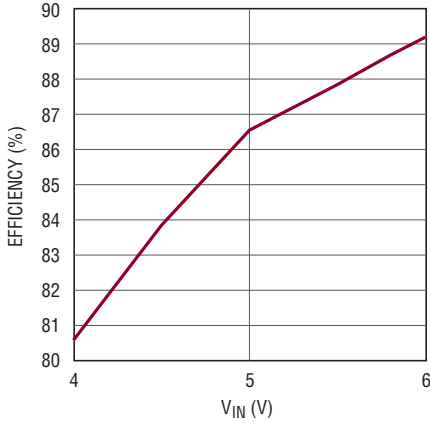

80421 G01

Efficiency vs V_{IN} , Boost Operation, 10.1V at 1A LED String

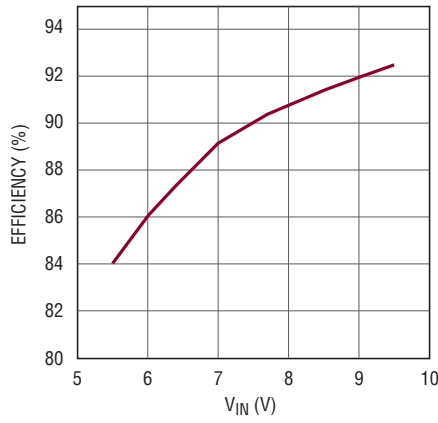

80421 G02

Efficiency vs V_{IN} , Boost Operation, 13.4V at 1A LED String

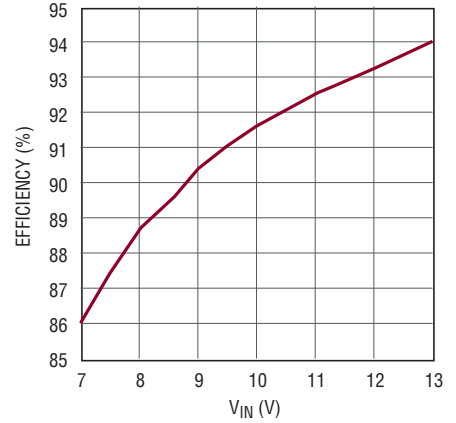

80421 G03

Efficiency vs V_{IN} , Boost Operation, 16.7V at 1A LED String

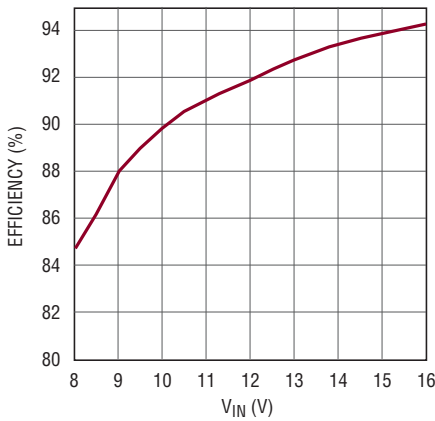

80421 G04

Efficiency vs V_{IN} , Boost Operation, 20.1V at 1A LED String

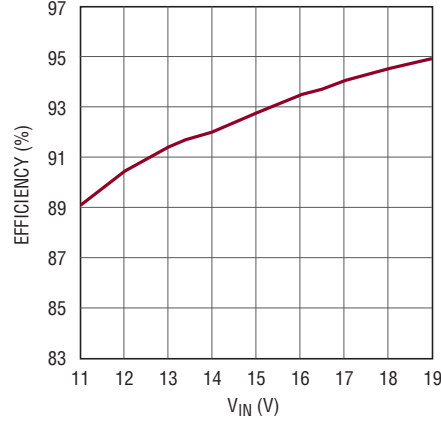

80421 G05

Efficiency vs V_{IN} , Boost Operation, 23.4V at 1A LED String

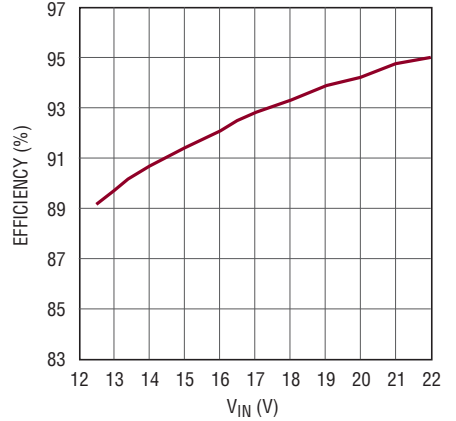

80421 G06

Efficiency vs V_{IN} , Boost Operation, 26.8V at 1A LED String

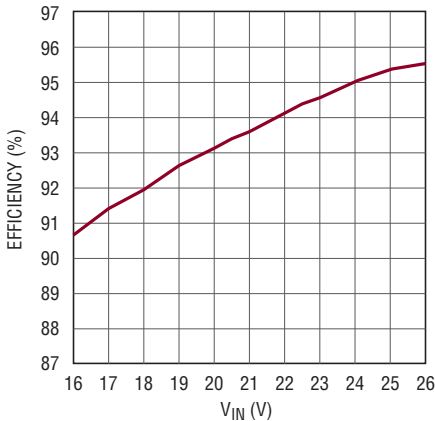

80421 G07

Efficiency vs V_{IN} , Buck Mode, 3.5V at 1A LED String

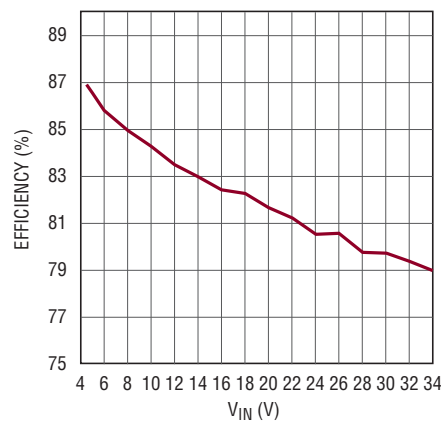

80421 G08

Efficiency vs V_{IN} , Buck Mode, 6.8V at 1A LED String

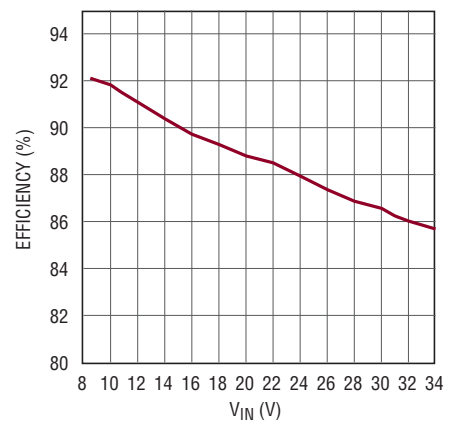

80421 G09

80421fa

TYPICAL PERFORMANCE CHARACTERISTICS $T_A = 25^\circ\text{C}$, unless otherwise noted.

LTM8042

Efficiency vs V_{IN} , Buck Mode, 10.1V at 1A LED String

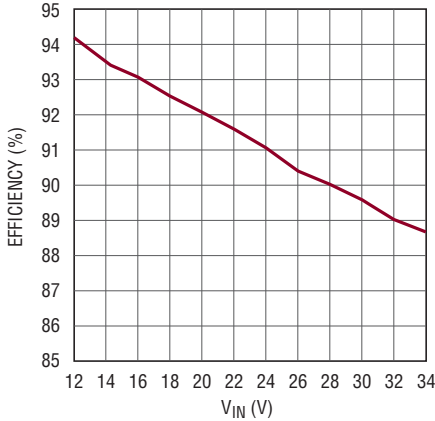

80421 G10

Efficiency vs V_{IN} , Buck Mode, 13.4V at 1A LED String

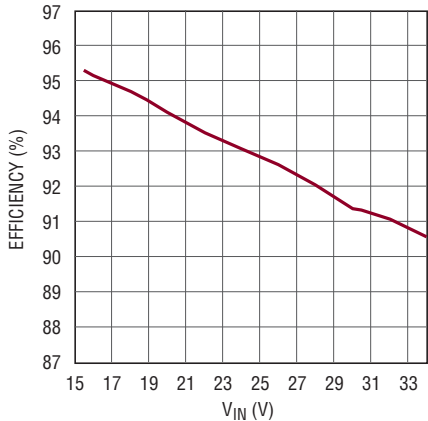

80421 G11

Efficiency vs V_{IN} , Buck Mode, 16.7V at 1A LED String

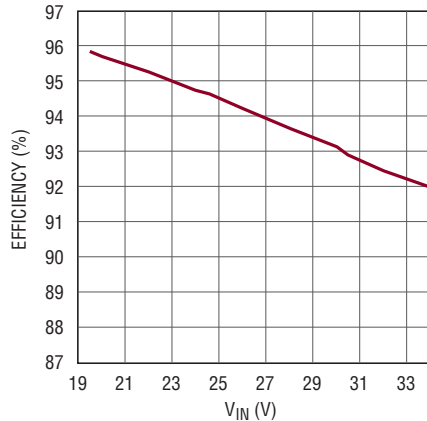

80421 G12

Efficiency vs V_{IN} , Buck-Boost Mode, 3.6V at 1A LED String

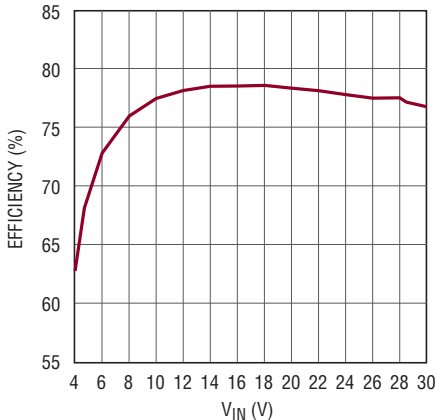

80421 G13

Efficiency vs V_{IN} , Buck-Boost Mode, 6.8V at 1A LED String

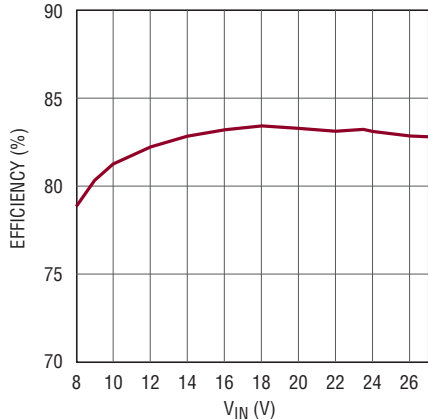

80421 G14

Efficiency vs V_{IN} , Buck-Boost Mode, 10.1V at 1A LED String

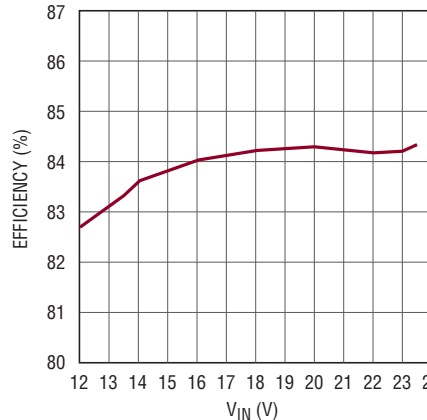

80421 G15

Efficiency vs V_{IN} , Buck-Boost Mode, 13.4V at 1A LED String

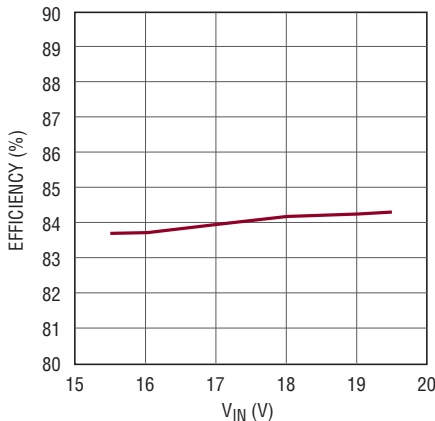

80421 G16

Maximum LED Current vs Input Voltage, Boost Operation

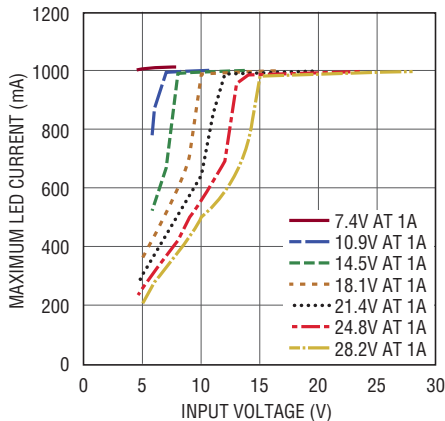

80421 G17

TYPICAL PERFORMANCE CHARACTERISTICS $T_A = 25^\circ\text{C}$, unless otherwise noted.

LTM8042

Maximum LED Current vs V_{IN} , Buck Mode

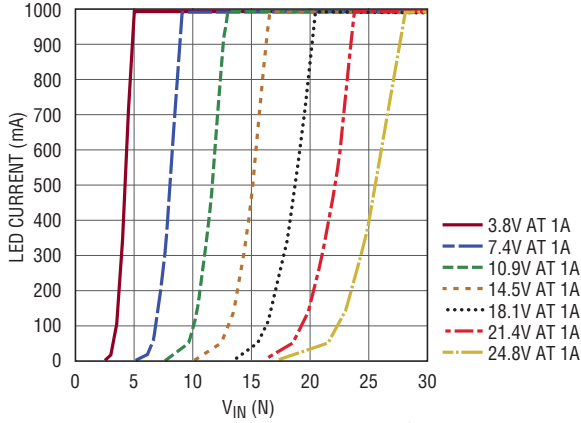

Maximum LED Current vs Input Voltage, Buck-Boost Mode

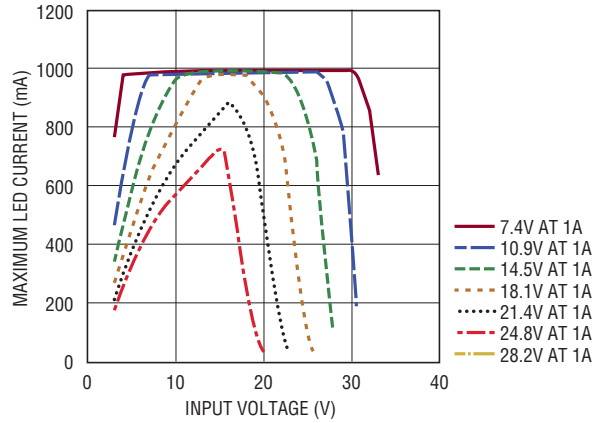

LED Current vs CTL Voltage

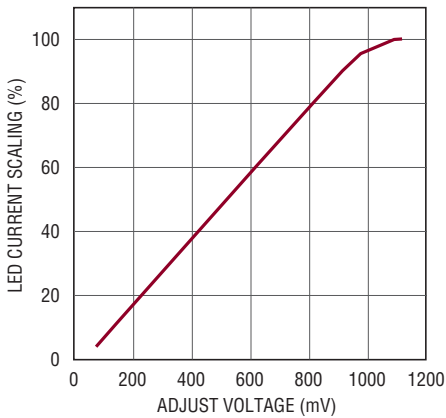

Quiescent Current vs Input Voltage, Open LED

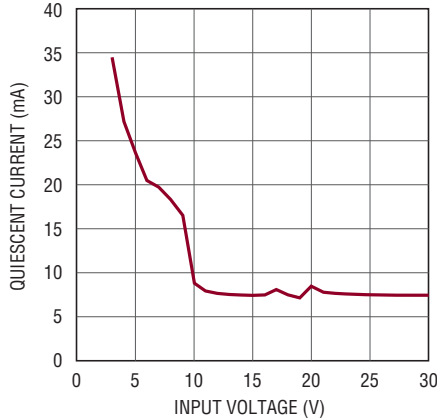

Junction Temperature Rise vs Load, Boost Operation, 8.3V at 1A LED String

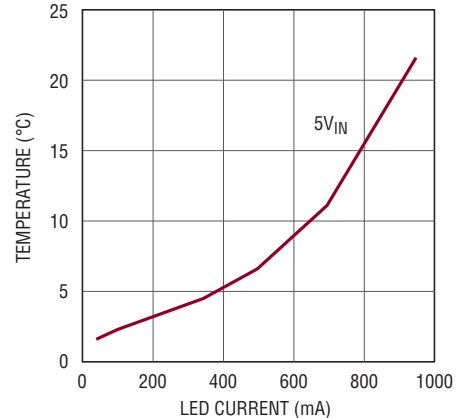

Junction Temperature Rise vs Load, Boost Operation, 10.9V at 1A LED String

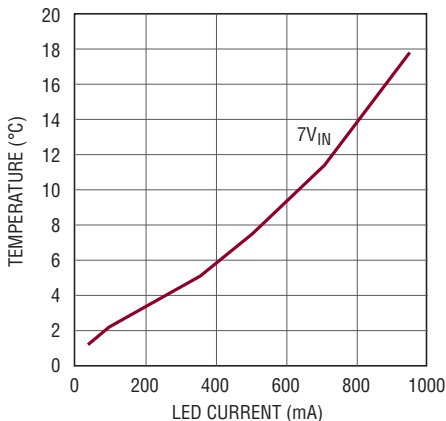

Junction Temperature Rise vs Load, Boost Operation, 13.6V at 1A LED String

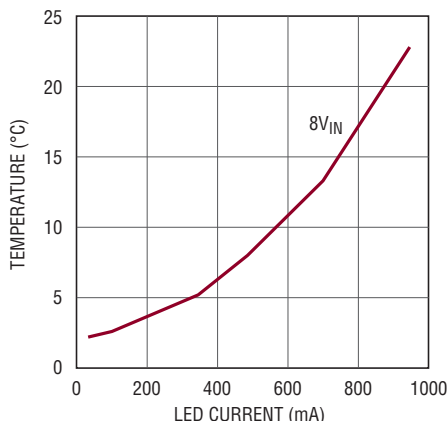

Junction Temperature Rise vs Load, Boost Operation, 18.1V at 1A LED String

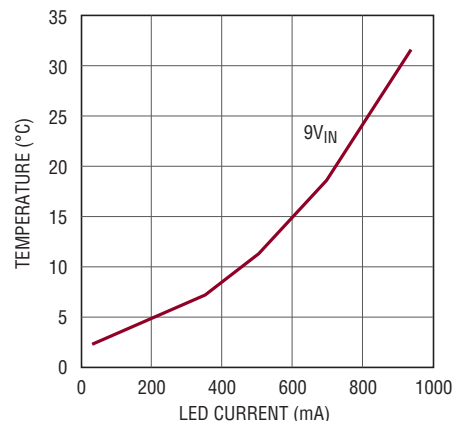

TYPICAL PERFORMANCE CHARACTERISTICS $T_A = 25^\circ\text{C}$, unless otherwise noted.

LTM8042

Junction Temperature Rise vs Load, Buck Mode, 2.9V at 1A LED String

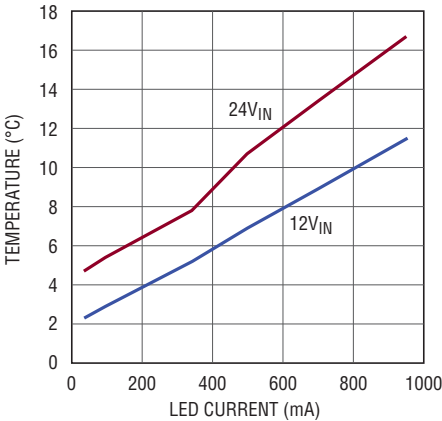

80421 G26

Junction Temperature Rise vs Load, Buck Mode, 3.8V at 1A LED String

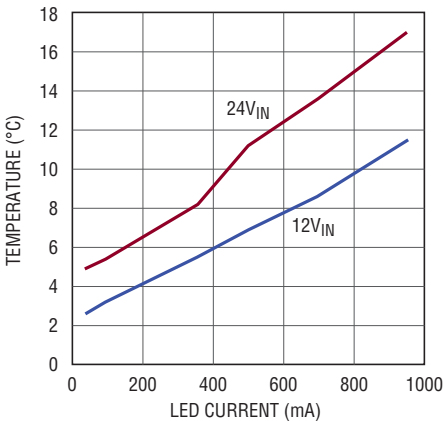

80421 G27

Junction Temperature Rise vs Load, Buck Mode, 8.3V at 1A LED String

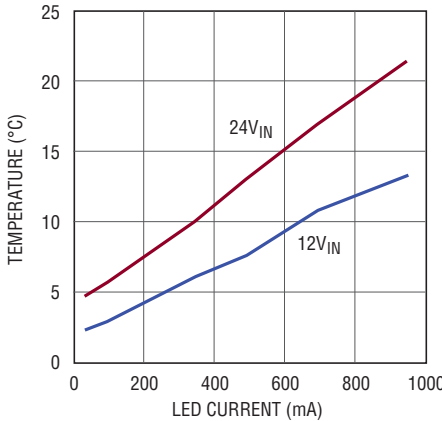

80421 G28

Junction Temperature Rise vs Load, Buck Mode, 10.9V at 1A LED String

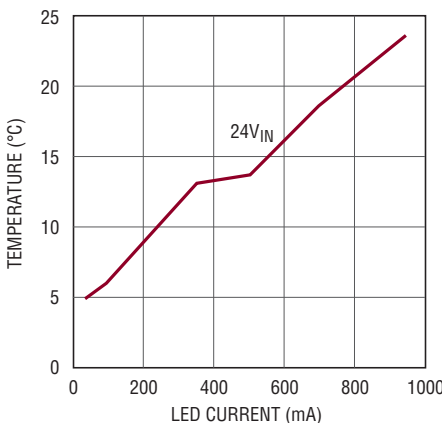

80421 G29

Junction Temperature Rise vs Load, Buck Mode, 13.6V at 1A LED String

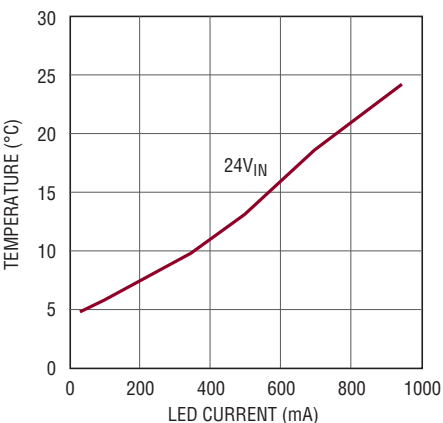

80421 G30

Junction Temperature Rise vs Load, Buck Mode, 18.1V at 1A LED String

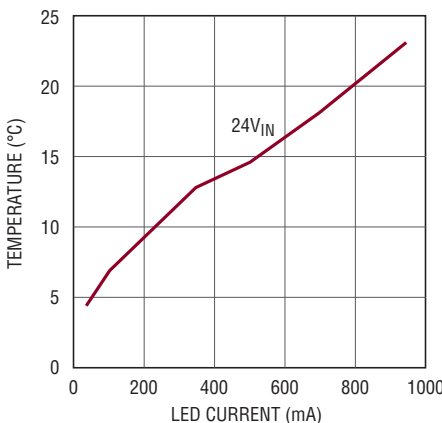

80421 G31

Junction Temperature Rise vs Load, Buck-Boost Mode, 2.9V at 1A LED String

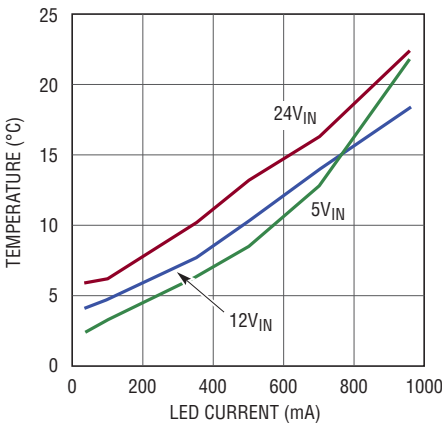

80421 G32

Junction Temperature Rise vs Load, Buck-Boost Mode, 3.8V at 1A LED String

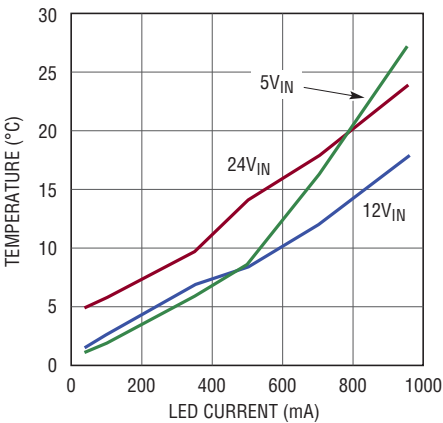

80421 G33

Junction Temperature Rise vs Load, Buck-Boost Mode, 8.3V at 1A LED String

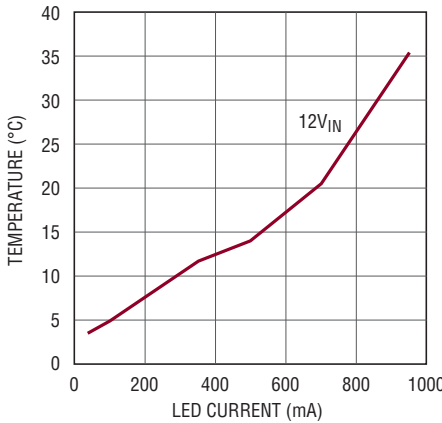

80421 G34

80421fa

LTM8042/LTM8042-1

TYPICAL PERFORMANCE CHARACTERISTICS $T_A = 25^\circ\text{C}$, unless otherwise noted.

LTM8042

Junction Temperature Rise vs Load, Buck-Boost Mode, 10.9V at 1A LED String

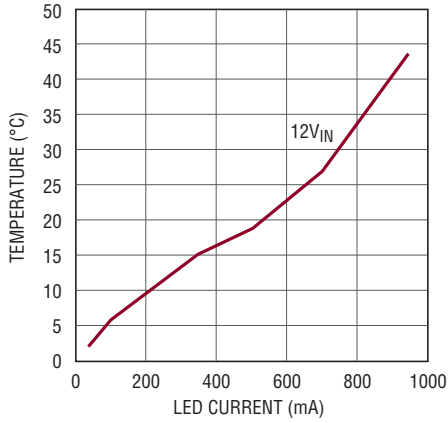

80421 G35

Junction Temperature Rise vs Load, Buck-Boost Mode, 13.6V at 1A LED String

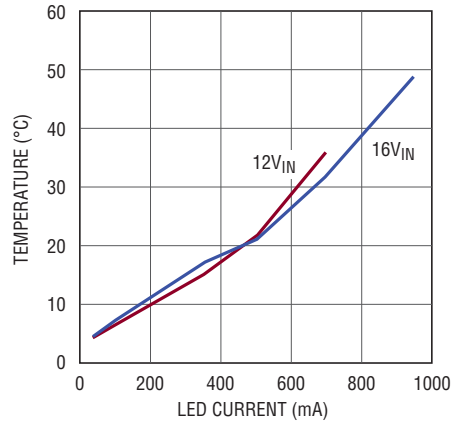

80421 G36

Junction Temperature Rise vs Load, Buck-Boost Mode, 15.5V at 350mA LED String

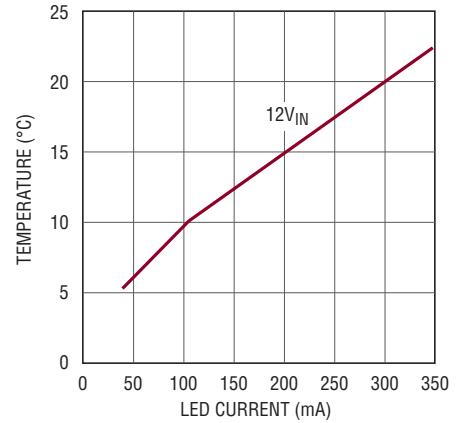

80421 G37

LTM8042/LTM8042-1

RUN Pin Current vs Voltage

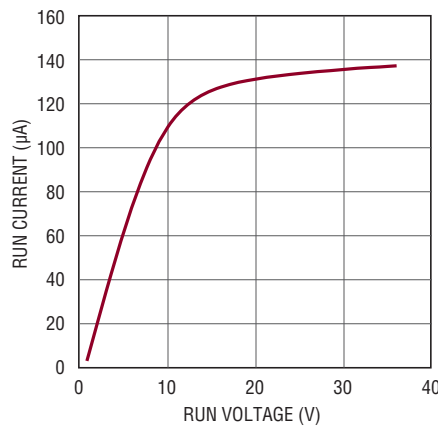

80421 G38

LTM8042-1

Efficiency vs V_{IN}, Boost Operation, 6.7V at 350mA LED String

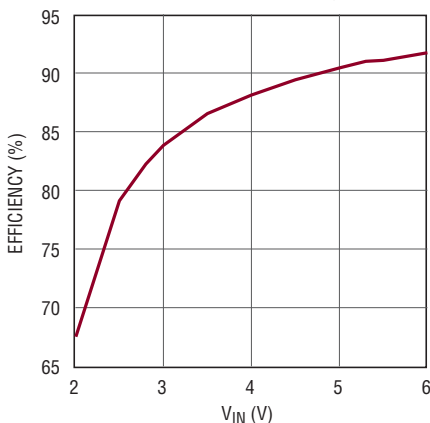

80421 G39

Efficiency vs V_{IN}, Boost Operation, 9.7V at 350mA LED String

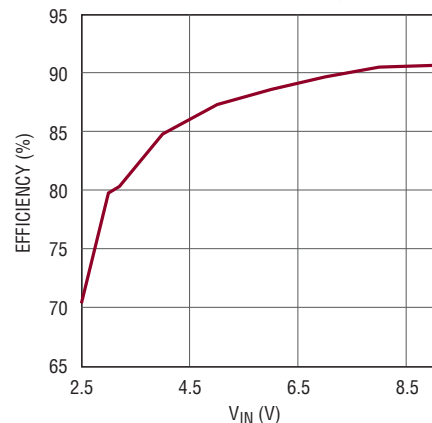

80421 G40

Efficiency vs V_{IN}, Boost Operation, 12.6V at 350mA LED String

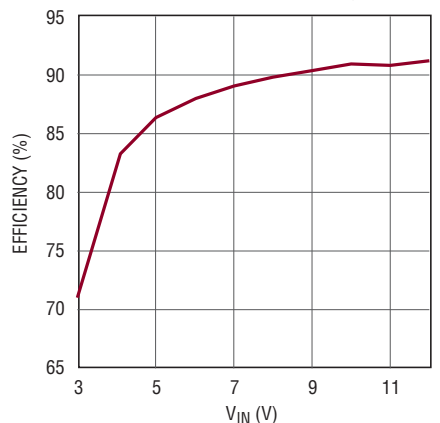

80421 G41

80421fa

TYPICAL PERFORMANCE CHARACTERISTICS $T_A = 25^\circ\text{C}$, unless otherwise noted.

LTM8042-1

Efficiency vs V_{IN} , Boost Operation, 15.6V at 350mA LED String

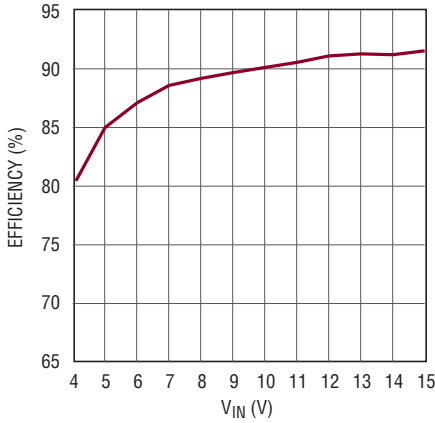

80421 G42

Efficiency vs V_{IN} , Boost Operation, 18.6V at 350mA LED String

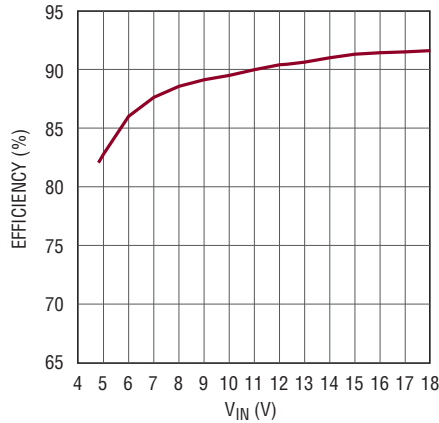

80421 G43

Efficiency vs V_{IN} , Boost Operation, 21.6V at 350mA LED String

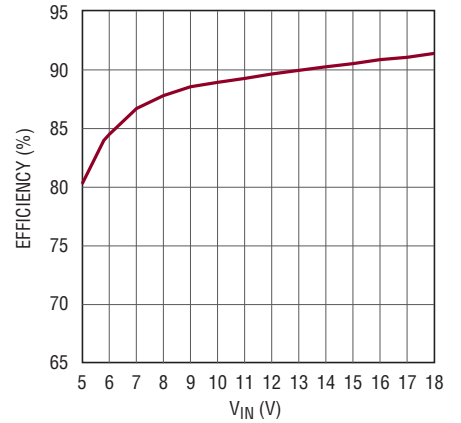

80421 G44

Efficiency vs V_{IN} , Boost Operation, 24.8V at 350mA LED String

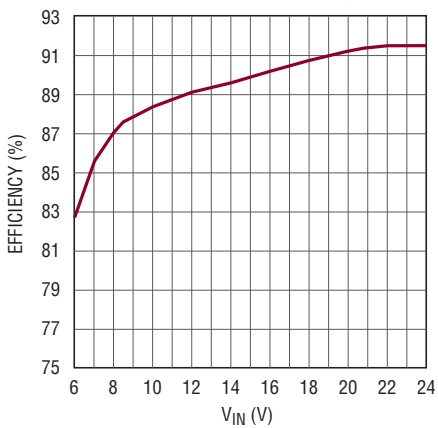

80421 G45

Efficiency vs V_{IN} , Buck Mode, 3.7V at 350mA LED String

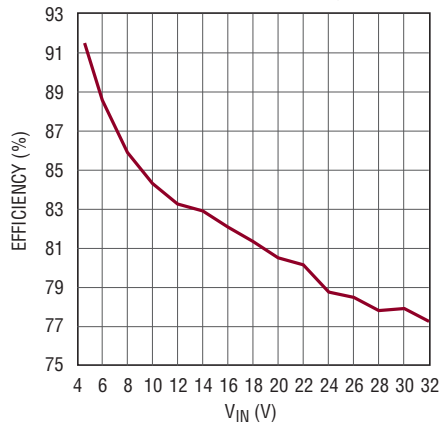

80421 G46

Efficiency vs V_{IN} , Buck Mode, 6.7V at 350mA LED String

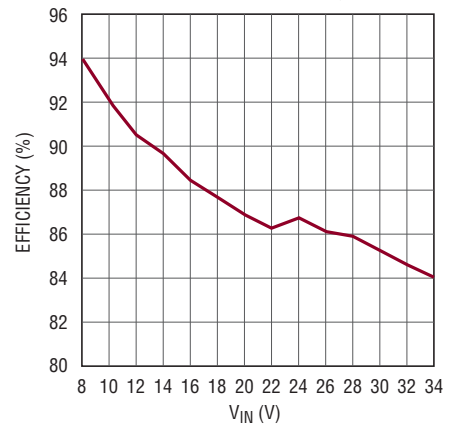

80421 G47

Efficiency vs V_{IN} , Buck Mode, 9.7V at 350mA LED String

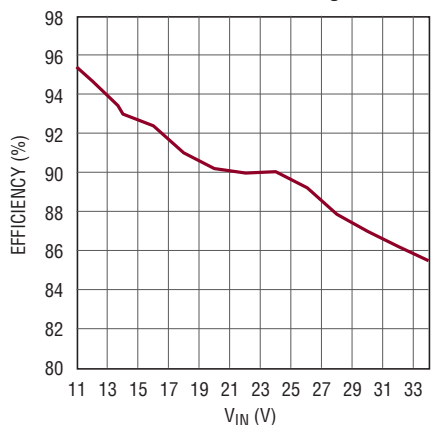

80421 G48

Efficiency vs V_{IN} , Buck Mode, 12.6V at 350mA LED String

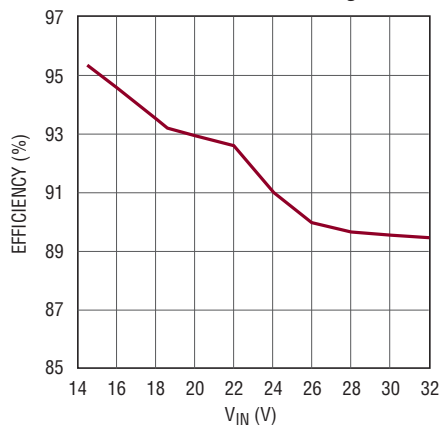

80421 G49

Efficiency vs V_{IN} , Buck Mode, 15.6V at 350mA LED String

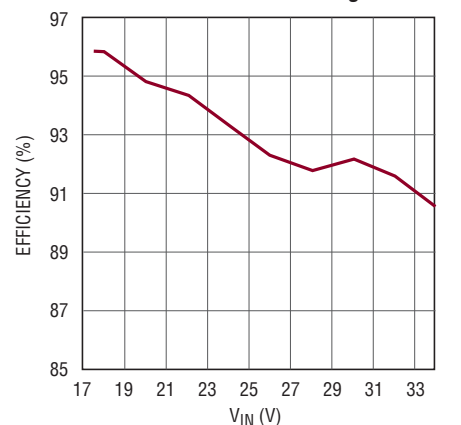

80421 G50

TYPICAL PERFORMANCE CHARACTERISTICS $T_A = 25^\circ\text{C}$, unless otherwise noted.

LTM8042-1

Efficiency vs V_{IN} , Buck Mode, 18.6V at 350mA LED String

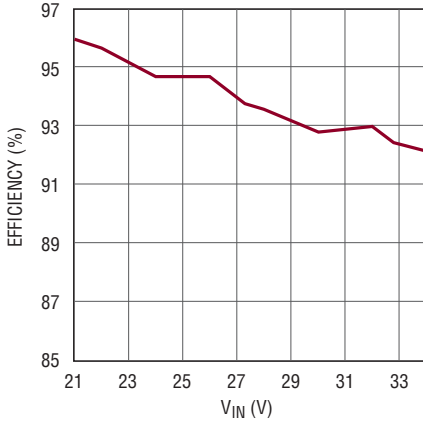

80421 G51

Efficiency vs V_{IN} , Buck-Boost Mode, 3.7V at 350mA LED String

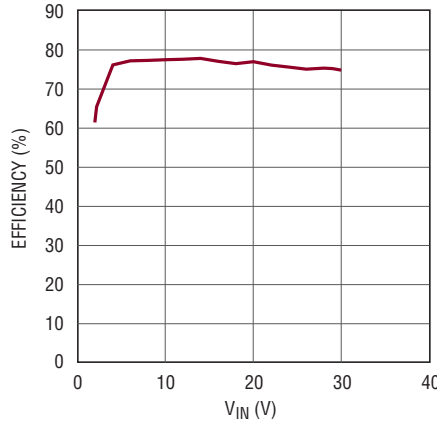

80421 G52

Efficiency vs V_{IN} , Buck-Boost Mode, 6.7V at 350mA LED String

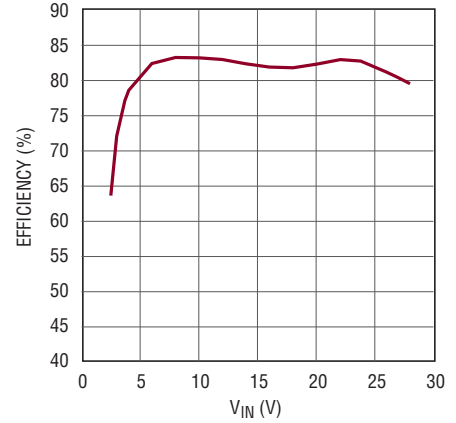

80421 G53

Efficiency vs V_{IN} , Buck-Boost Mode, 9.7V at 350mA LED String

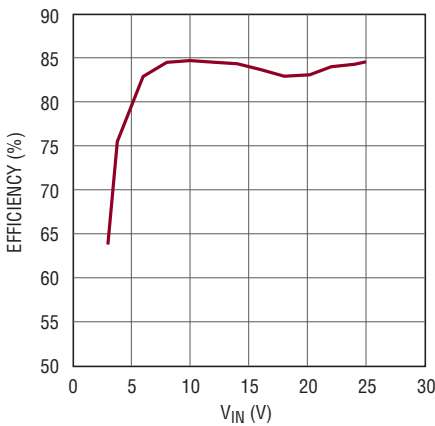

80421 G54

Efficiency vs V_{IN} , Buck-Boost Mode, 12.6V at 350mA LED String

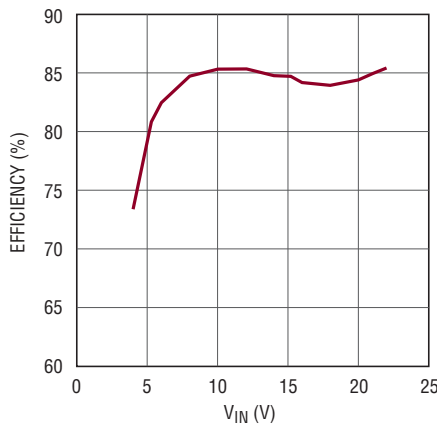

80421 G55

Efficiency vs V_{IN} , Buck-Boost Mode, 15.6V at 350mA LED String

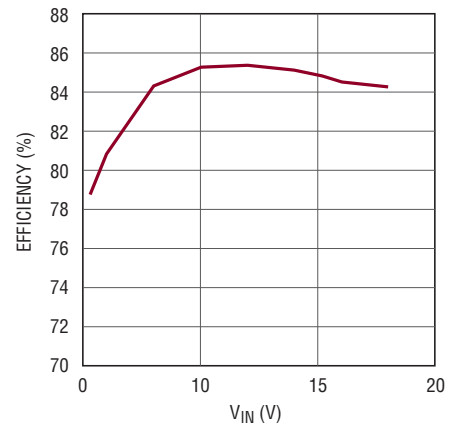

80421 G56

Efficiency vs V_{IN} , Buck-Boost Mode, 18.6V at 350mA LED String

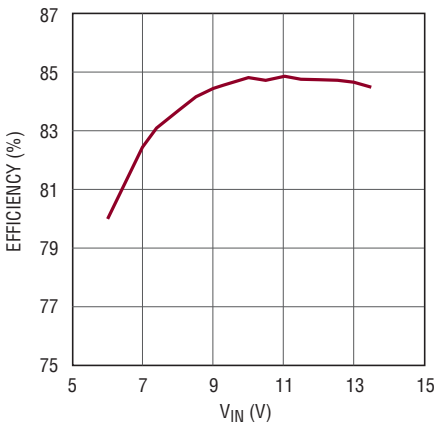

80421 G57

Maximum LED Current vs Input Voltage, Boost Operation

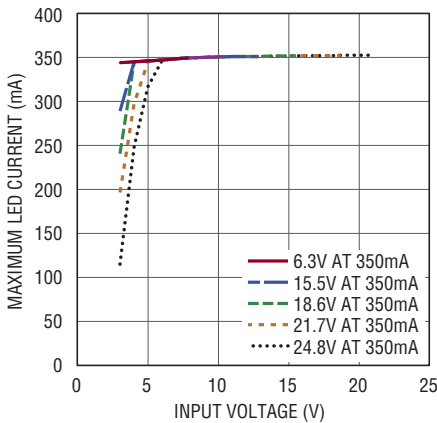

80421 G58

Maximum LED Current vs Input Voltage, Buck Mode

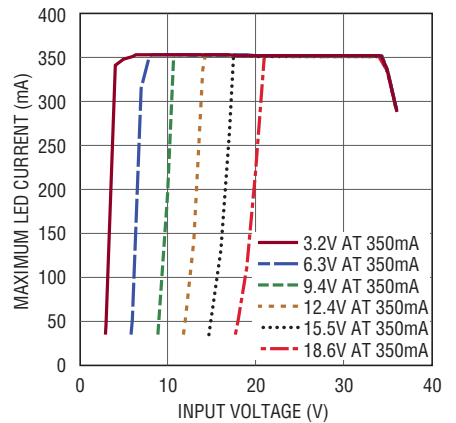

80421 G59

80421fa

TYPICAL PERFORMANCE CHARACTERISTICS $T_A = 25^\circ\text{C}$, unless otherwise noted.

LTM8042-1

Maximum LED Current vs Input Voltage, Buck-Boost Mode

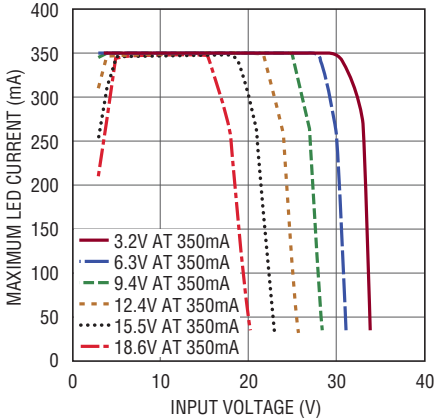

80421 G60

LED Current vs CTL Voltage

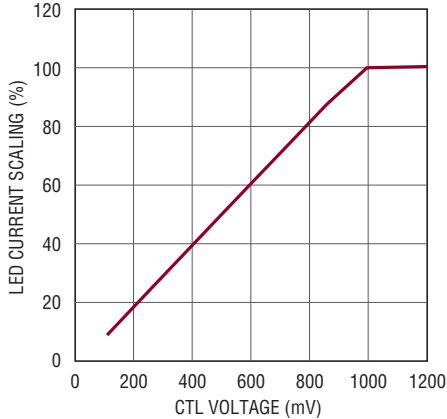

80421 G61

Quiescent Current vs Input Voltage, Open LED

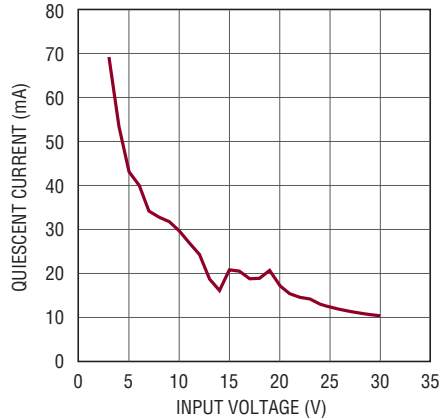

80421 G62

Junction Temperature Rise vs Load, Boost Operation, 6.8V at 350mA LED String

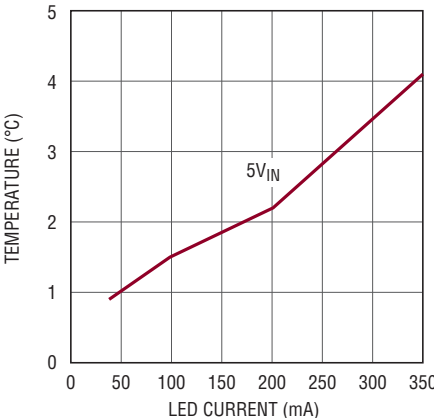

80421 G63

Junction Temperature Rise vs Load, Boost Operation, 9.4V at 350mA LED String

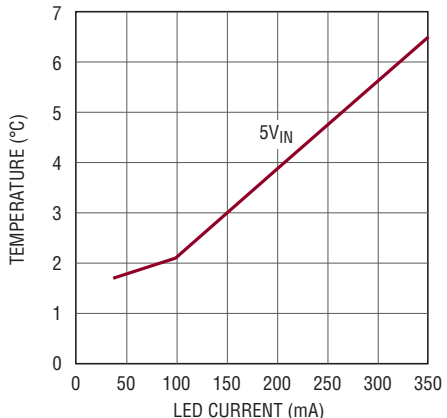

80421 G64

Junction Temperature Rise vs Load, Boost Operation, 11.2V at 350mA LED String

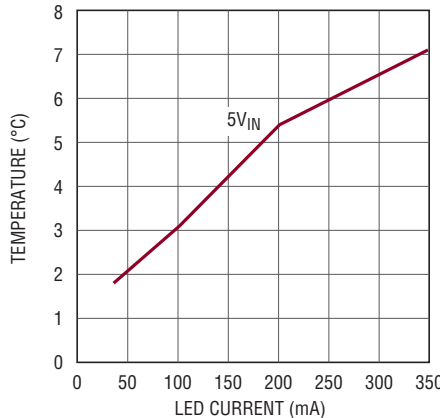

80421 G65

Junction Temperature Rise vs Load, Boost Operation, 15.5V at 350mA LED String

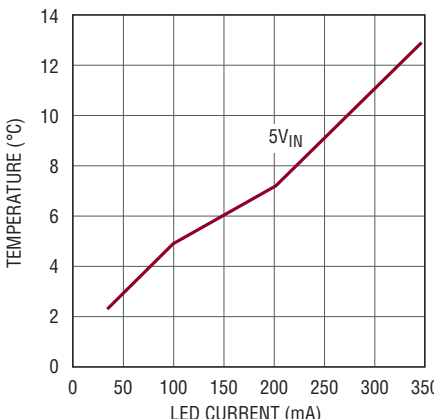

80421 G66

Junction Temperature Rise vs Load, Buck Mode, 2.3V at 350mA LED String

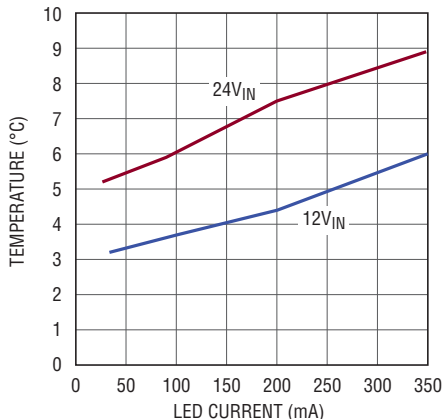

80421 G67

Junction Temperature Rise vs Load, Buck Mode, 3.2V at 350mA LED String

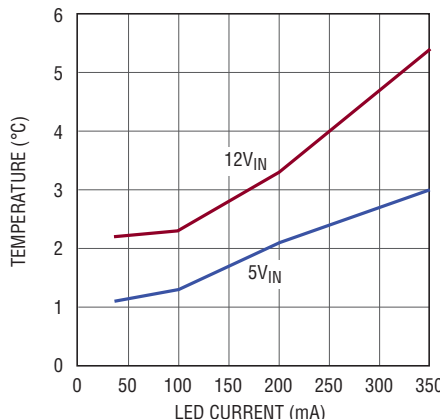

80421 G68

80421fa

TYPICAL PERFORMANCE CHARACTERISTICS $T_A = 25^\circ\text{C}$, unless otherwise noted.

LTM8042-1

Junction Temperature Rise vs Load, Buck Mode, 6.8V at 350mA LED String

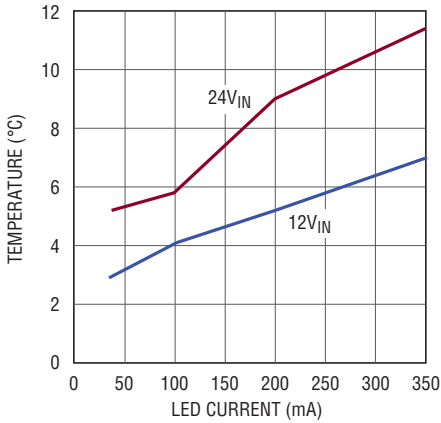

80421 G69

Junction Temperature Rise vs Load, Buck Mode, 9.4V at 350mA LED String

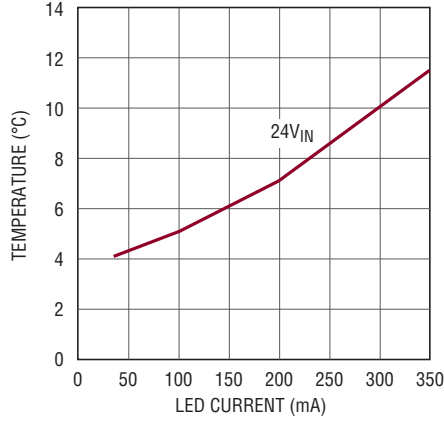

80421 G70

Junction Temperature Rise vs Load, Buck Mode, 11.2V at 350mA LED String

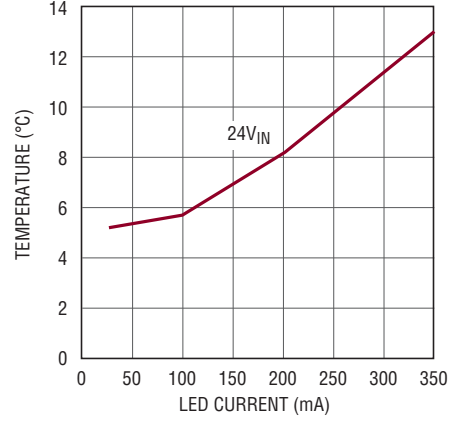

80421 G71

Junction Temperature Rise vs Load, Buck Mode, 15.5V at 350mA LED String

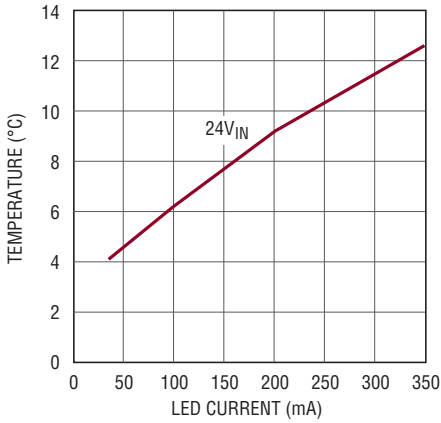

80421 G72

Junction Temperature Rise vs Load, Buck-Boost Mode, 2.3V at 350mA LED String

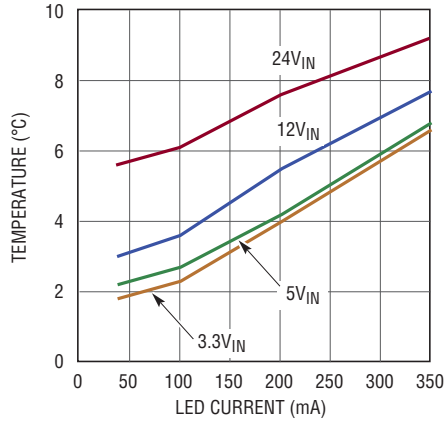

80421 G73

Junction Temperature Rise vs Load, Buck-Boost Mode, 3.2V at 350mA LED String

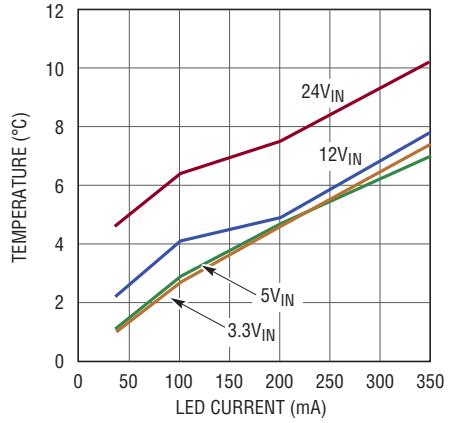

80421 G74

Junction Temperature Rise vs Load, Buck-Boost Mode, 6.8V at 350mA LED String

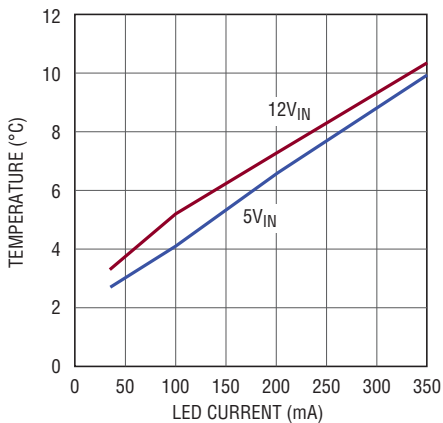

80421 G75

Junction Temperature Rise vs Load, Buck-Boost Mode, 9.4V at 350mA LED String

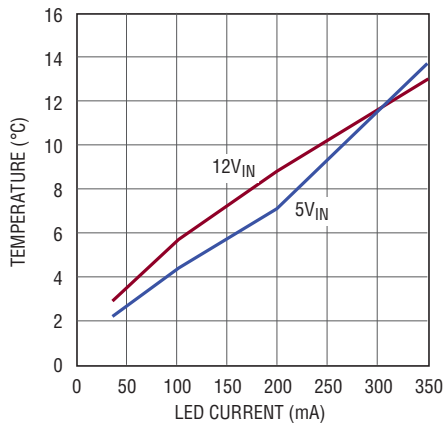

80421 G76

80421fa

TYPICAL PERFORMANCE CHARACTERISTICS $T_A = 25^\circ\text{C}$, unless otherwise noted.

LTM8042-1

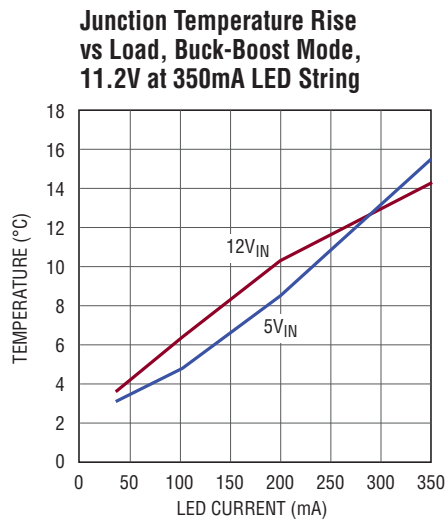

80421 G77

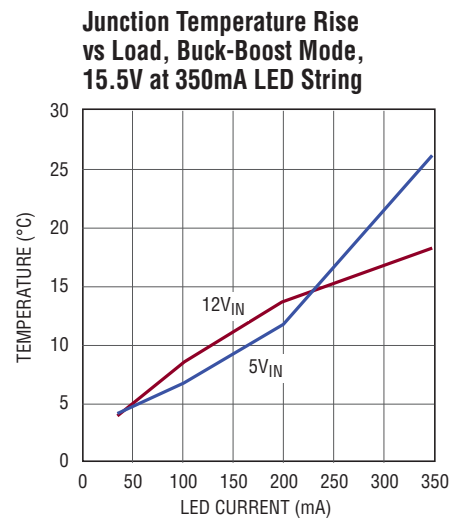

80421 G78

PIN FUNCTIONS

GND (Bank 1): Signal and Power Return. Tie these pads to a local ground plane below the LTM8042/LTM8042-1 and the circuit components. In most applications, the bulk of the heat flow out of the LTM8042/LTM8042-1 is through these pads, so the printed circuit design has a large impact on the thermal performance of the part. See the PCB Layout and Thermal Considerations sections for more details.

V_{CC} (Bank 2): Internal Housekeeping Power for the LTM8042/LTM8042-1. Connect to an external power source between 3V and 30V. The LTM8042/LTM8042-1 can withstand transients of 40V.

BSTIN/BKLED⁻ (Bank 3): Power Input for Boost Operation, as Well as the Cathode Connection for the LED String in Buck Mode. If the LTM8042/LTM8042-1 is used in boost mode, these pins must be locally decoupled.

BSTOUT/BKIN (Bank 4): Output of the Boost Converter, as Well as the Input for Buck Mode. If the LTM8042/LTM8042-1 is used in buck mode, these pins must be locally decoupled.

LED⁺ (Bank 5): Connect this to the anode of the LED string. This can also be connected to the PWM dimming MOSFET if used.

RUN (Pin F1): Module Enable. Tie to 1.5V or higher to enable the LTM8042/LTM8042-1 or 0.4V or less to disable device.

SYNC (Pin G1): Frequency Synchronization Pin. Tie an external clock signal here. The RT resistor should be chosen to program a switching frequency that is 20% slower than SYNC pulse frequency. Tie the SYNC pin to GND if this feature is not used.

RT (Pin H1): Timing Resistor Pin. Used to program the switching frequency of the LTM8042/LTM8042-1 by connecting a resistor from this pin to GND. The Applications Information section of the data sheet includes a table to determine the resistance value based on the desired switching frequency. Minimize capacitance at this pin.

SS (Pin J1): Soft-Start Pin. Place a soft-start capacitor here. Leave the pin open if not used.

PIN FUNCTIONS

TG (Pin J7): Top Gate Driver Output. In response to an active high PWM signal, this pin will drive the gate of an external series P-channel MOSFET device low. An internal 7V clamp protects the PFET gate. This pin can also be used to disconnect the load when RUN is pulled low. Leave TG unconnected if not used.

PWM (Pin K1): Pulse Width Modulation Input Pin. A low signal turns off the LED string, disables the main switch and pulls the TG pin high. Drive above 1.55V to deliver current to the output. Tie the PWM pin to the RUN pin if not used. There is an equivalent 50k resistor from PWM pin to ground internally.

CTL (Pin L2): LED Current Adjustment Pin. Apply a voltage between approximately 1V and 0V to modulate the LED⁺ output current, or tie a resistor to GND to modulate the LED⁺ current. CTL is internally tied to a 2V precision reference via a 20k 1% resistor. Leave floating if unused.

TGEN (Pin L3): Top Gate (TG) Enable Input Pin. Tie to 1.5V or higher to enable the P-channel MOSFET driver function. Tie the TGEN pin to ground if the TG function is not used. There is an internal 40k resistor from TGEN to GND.

BLOCK DIAGRAM

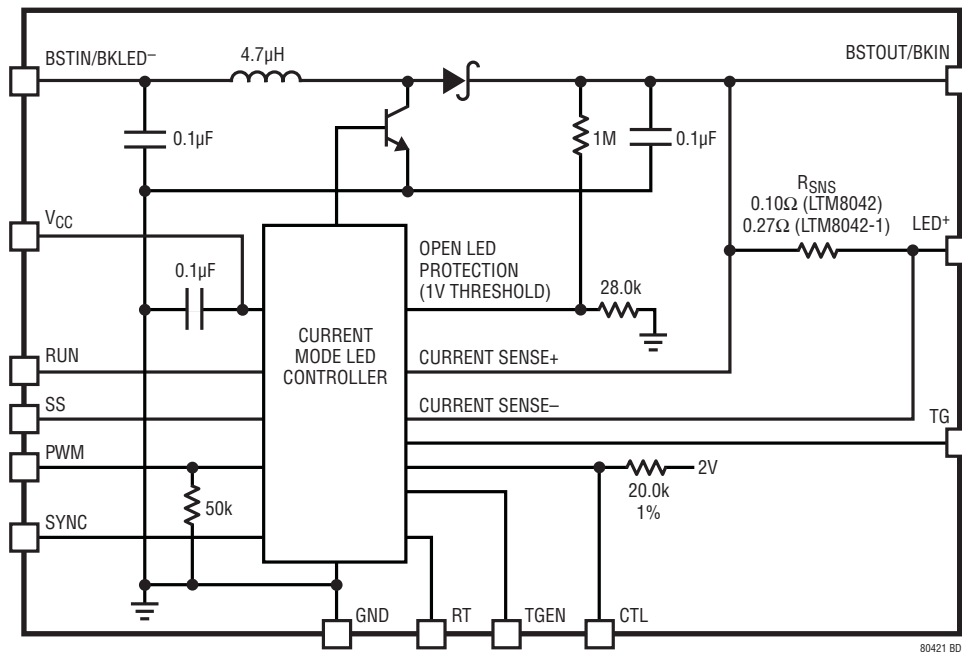

80421 BD

OPERATION

The LTM8042/LTM8042-1 is a complete, full featured, current mode regulator specifically designed to drive light emitting diodes (LEDs) or other loads where a constant current up to 1A (350mA for the LTM8042-1) is required.

The LTM8042/LTM8042-1 can operate in any of three LED drive topologies: boost, buck mode and buck-boost mode. The device features both analog and PWM dimming, a PWM P-channel MOSFET driver, and a suite of control functions: RUN control, soft-start, user programmable switching frequency, and external frequency synchronization.

Operation can be best understood by referring to the Block Diagram. The power stage is a boost converter that regulates the output current by reading the voltage across a power sense resistor that is in series with the output.

As with any boost topology, there is an uninterrupted current path between the input and output terminals. Current between these two terminals is not limited, so **the device is intolerant to a short-circuit or overload from any of the output terminals (LED⁺, BSTOUT/BKIN) to GND.**

There are two ways to dim a LED with the LTM8042/LTM8042-1. One way is to adjust the current on the LED array by setting the analog voltage on the CTL pin. The CTL pin is internally pulled up to a precision 2V reference through a 1% 20k resistor. Leaving the CTL pin floating sets the LED pin current to 1A. Reducing the voltage below 1.1V on the CTL pin proportionally reduces the current flowing out of LED⁺. This can be accomplished by connecting a resistor from the CTL pin to GND, forming a divider network with the internal 20k resistor, or by driving the CTL pin directly to a voltage source, such as a DAC.

The other way the LTM8042/LTM8042-1 can dim a LED array is by pulse width modulation using the PWM pin and an optional external P-channel MOSFET. The external P-channel MOSFET can be conveniently operated by the integrated gate driver at pin TG. The gate drive function can be enabled or disabled by the TGEN pin.

If the PWM pin is pulled high, the part operates normally. If the PWM pin is unconnected or pulled low, the LTM8042/LTM8042-1 stops switching and the internal control circuitry is held in its present state. This way, the LTM8042/LTM8042-1 “remembers” the current sourced from the LED⁺ output until PWM is pulled high again. This leads to a highly linear relationship between pulse width and output light, allowing for a large and accurate dimming range.

The RUN pin is used to deactivate the LTM8042/LTM8042-1. When the RUN pin is pulled to a logic low state, the device is shut down and draws typically less than 1 μ A of current.

The SS pin is used to limit inrush current during start-up. The LTM8042/LTM8042-1 integrates a current source with this function, so only a capacitor is necessary to establish the soft-start characteristics of the output current.

The switching frequency is set by applying a single resistor from the RT pin to GND, allowing operation anywhere from 250kHz to 2MHz, and the SYNC pin allows synchronization to an external source between 300kHz and 2.5MHz.

APPLICATIONS INFORMATION

For most applications, the design process is straight forward, summarized as follows:

1. Decide whether the LTM8042/LTM8042-1 should operate in boost, buck, or buck-boost mode.
2. Look at Tables 1 through 6 and find the line that best matches the input and output conditions of the system under consideration.
3. Connect C_{IN} , C_{OUT} , C_{VCC} and R_T as indicated in the appropriate table.
4. Connect the remaining pins as needed by the system requirements.

While these component combinations have been tested for proper operation, it is incumbent upon the user to verify proper operation over the intended system's line, load and environmental conditions.

If the desired LED current is not listed in Tables 1 through 6, set it by applying the proper voltage the CTL pin. Graphs of the LTM8042/LTM8042-1 LED current scaling vs CTL voltage are given in the Typical Performance Characteristics section. If a voltage source is not available to drive the CTL pin, a resistor may be applied from the CTL pin to GND. The CTL pin is internally pulled up to a 2V reference voltage through a 20k resistor (please see the Block Diagram for details).

Open LED Protection

The LTM8042/LTM8042-1 has internal open LED circuit protection. If the LED is absent or fails open, the LTM8042/LTM8042-1 clamps the voltage on the LED+ and BSTOUT/BKIN pin to protect the output against overvoltage. The internal boost switching converter then regulates its output to 36V. In buck mode, the full open LED voltage is stood off by the internal power Schottky diode. At high operating temperatures, the power Schottky reverse leakage current will rise. This increases the power dissipation within the diode, which raises the junction temperature. This temperature rise can be large, so care needs to be taken at high operating temperatures.

Setting the Switching Frequency

The LTM8042/LTM8042-1 uses a constant frequency architecture that can be programmed over a 250kHz to 2MHz range with a single external timing resistor from the RT pin to ground. Table 7 shows suggested R_T selections for a variety of switching frequencies.

Table 7. Switching Frequency vs R_T

SWITCHING FREQUENCY (kHz)	R_T (k Ω)
250	86.6
500	37.4
800	21.0
1000	15.8
1500	9.09
2000	6.04

The other way to set the operating frequency of the LTM8042/LTM8042-1 is to drive the SYNC pin with an external signal. For proper operation, a resistor should be connected at the RT pin and be able to generate a switching frequency 20% lower than the external clock when the external clock is absent.

In general, a lower switching frequency should be used where either very high or very low switching duty cycle operation is required, or high efficiency is desired. Selection of a higher switching frequency will allow use of smaller value external components and yield a smaller solution size and profile.

Operating Modes

The LTM8042/LTM8042-1 employs a ground referred power switch to implement a boost power switching circuit. As such, it can be used to implement the three most popular LED driving topologies: boost, buck mode, and buck-boost mode. Example layouts of each operating mode are given in Figures 2 through 4 and schematics are shown in the Typical Applications section.

APPLICATIONS INFORMATION

PCB Layout

Most of the headaches associated with PCB layout have been alleviated or even eliminated by the high level of integration of the LTM8042/LTM8042-1. The device is nevertheless a switching power supply, and care must be taken to minimize EMI and ensure proper operation. Even with the high level of integration, you may fail to achieve specified operation with a haphazard or poor layout. See Figures 2, 3 and 4 for suggested layouts of boost, buck and buck-boost operating modes.

Ensure that the grounding and heat sinking are acceptable. A few rules to keep in mind are:

1. Place the R_T resistor as close as possible to its respective pins.
2. Place the C_{IN} and C_{VCC} capacitor as close as possible to the V_{IN} and GND connections of the LTM8042/LTM8042-1.
3. Place the C_{OUT} capacitor as close as possible to the BSTOUT/BKIN or BSTIN/BKLED⁻ and GND connection of the LTM8042/LTM8042-1.

4. Place the C_{IN} , C_{VCC} and C_{OUT} capacitors such that their ground current flows directly adjacent to or underneath the LTM8042/LTM8042-1.
5. Connect all of the GND connections to as large a copper pour or plane area as possible on the top layer. Avoid breaking the ground connection between the external components and the LTM8042/LTM8042-1.

Use vias to connect the GND copper area to the board's internal ground planes. Liberally distribute these GND vias to provide both a good ground connection and thermal path to the internal planes of the printed circuit board. Pay attention to the location and density of the thermal vias in Figures 2 through 4. The LTM8042/LTM8042-1 can benefit from the heat sinking afforded by vias that connect to internal GND planes at these locations, due to their proximity to internal power handling components. The optimum number of thermal vias depends upon the printed circuit board design. For example, a board might use very small via holes. It should employ more thermal vias than a board that uses larger holes.

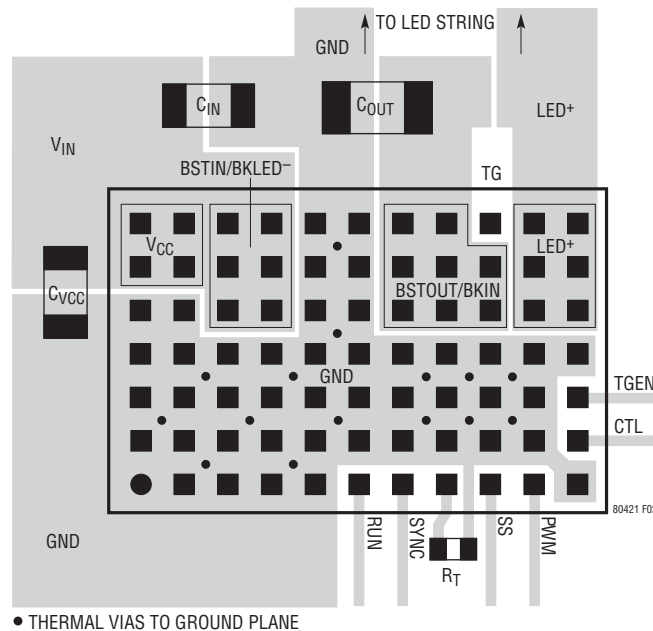
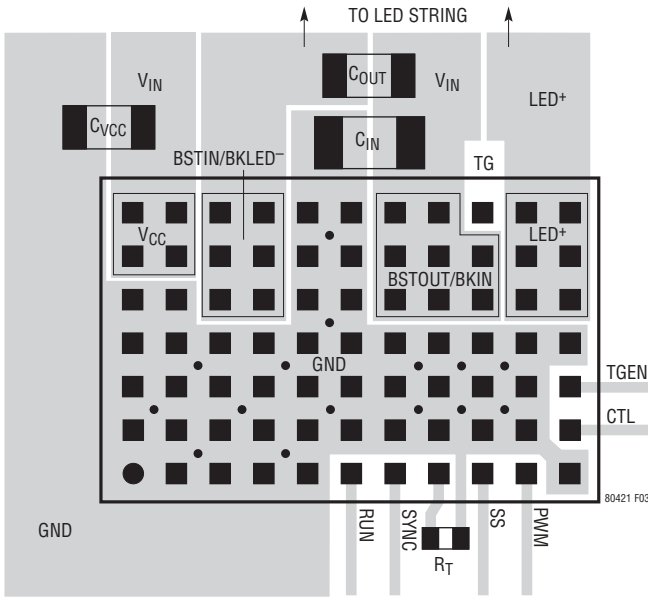

Figure 2. Suggested Layout for Boost Operation

APPLICATIONS INFORMATION



• THERMAL VIAS TO GROUND PLANE

Figure 3. Suggested Layout for Buck Mode

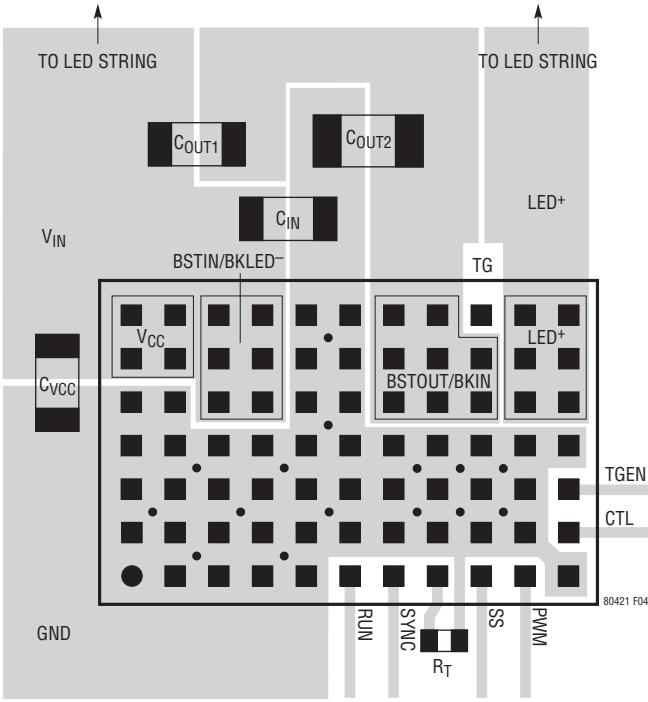

• THERMAL VIAS TO GROUND PLANE

Figure 4. Suggested Layout for Buck-Boost Mode

APPLICATIONS INFORMATION

Table 1. LTM8042 Recommended Values and Configuration for Boost ($T_A = 25^\circ\text{C}$)

V_{IN} RANGE (BSTIN/ BKLED ⁻)	V_{CC}	C_{IN} (BSTIN/BKLED ⁻ TO GND)	C_{OUT} (BSTOUT/BKIN TO GND)	LED STRING VOLTAGE (LED ⁺ TO GND)	LED STRING CURRENT	R_{CTL}	RT (OPTI- MAL)	f (OPTI- MAL)	RT (MIN)	f (MAX)
3V to 3.6V	Connect to BSTIN/BKLED ⁻	1 μ F 0805 X7R 10V	1 μ F 0805 X7R 10V	4V to 6V	35mA	523	86.6k	250k	37.4k	500k
3V to 5.1V	Connect to BSTIN/BKLED ⁻	1 μ F 0805 X7R 10V	1 μ F 0805 X7R 10V	6V to 9V	35mA	523	76.8k	275k	37.4k	500k
3V to 6.3V	Connect to BSTIN/BKLED ⁻	1 μ F 0805 X7R 10V	1 μ F 0805 X7R 16V	8V to 12V	35mA	523	69.8k	300k	37.4k	500k
3V to 9.3V	Connect to BSTIN/BKLED ⁻	1 μ F 0805 X7R 10V	1 μ F 0805 X7R 16V	12V to 16V	35mA	523	48.7k	400k	30.1k	600k
3V to 10V	Connect to BSTIN/BKLED ⁻	1 μ F 0805 X7R 10V	1 μ F 0805 X7R 25V	15V to 21V	35mA	523	37.4k	500k	27.4k	650k
3V to 12.6V	Connect to BSTIN/BKLED ⁻	1 μ F 0805 X7R 16V	1 μ F 0805 X7R 25V	18V to 24V	35mA	523	33.2k	550k	24.9k	700k
3.7V to 15V	Connect to BSTIN/BKLED ⁻	1 μ F 0805 X7R 16V	1 μ F 0805 X7R 50V	24V to 32V	35mA	523	30.1k	600k	24.9k	700k
3V to 3.85V	Connect to BSTIN/BKLED ⁻	4.7 μ F 1206 X7R 10V	2.2 μ F 1206 X7R 10V	4V to 6V	100mA	1.30k	86.6k	250k	37.4k	500k
3V to 5.6V	Connect to BSTIN/BKLED ⁻	4.7 μ F 1206 X7R 10V	2.2 μ F 1206 X7R 10V	6V to 9V	100mA	1.30k	76.8k	275k	37.4k	500k
3V to 7V	Connect to BSTIN/BKLED ⁻	4.7 μ F 1206 X7R 10V	2.2 μ F 1206 X7R 16V	8V to 12V	100mA	1.30k	69.8k	300k	37.4k	500k
3V to 10.2V	Connect to BSTIN/BKLED ⁻	4.7 μ F 1206 X7R 16V	2.2 μ F 1206 X7R 16V	12V to 16V	100mA	1.30k	48.7k	400k	30.1k	600k
4V to 12.6V	Connect to BSTIN/BKLED ⁻	4.7 μ F 1206 X7R 16V	2.2 μ F 1206 X7R 25V	15V to 21V	100mA	1.30k	37.4k	500k	30.1k	600k
4V to 14.5V	Connect to BSTIN/BKLED ⁻	2.2 μ F 1206 X7R 16V	2.2 μ F 1206 X7R 25V	18V to 24V	100mA	1.30k	30.1k	600k	24.9k	700k
6.3V to 18.7V	Connect to BSTIN/BKLED ⁻	2.2 μ F 1206 X7R 25V	2.2 μ F 1206 X7R 50V	24V to 32V	100mA	1.30k	24.9k	700k	21.0k	800k
3V to 3.8V	Connect to BSTIN/BKLED ⁻	1 μ F 0805 X7R 10V	2.2 μ F 1206 X7R 10V	4V to 6V	350mA	4.75k	27.4k	650k	16.9k	950k
3V to 5.5V	Connect to BSTIN/BKLED ⁻	1 μ F 0805 X7R 10V	2.2 μ F 1206 X7R 10V	6V to 9V	350mA	4.75k	27.4k	650k	16.9k	950k
3.3V to 7V	Connect to BSTIN/BKLED ⁻	1 μ F 0805 X7R 10V	2.2 μ F 1206 X7R 16V	8V to 12V	350mA	4.75k	27.4k	650k	16.9k	950k
4.1V to 10V	Connect to BSTIN/BKLED ⁻	1 μ F 0805 X7R 10V	2.2 μ F 1206 X7R 16V	12V to 16V	350mA	4.75k	19.6k	850k	15.8k	1M
5.5V to 12.5V	Connect to BSTIN/BKLED ⁻	1 μ F 1206 X7R 16V	2.2 μ F 1206 X7R 25V	15V to 21V	350mA	4.75k	18.2k	900k	12.4k	1.2M
6.4V to 15V	Connect to BSTIN/BKLED ⁻	1 μ F 1206 X7R 16V	2.2 μ F 1206 X7R 25V	18V to 24V	350mA	4.75k	16.9k	950k	14.0k	1.1M
9V to 20.8V	Connect to BSTIN/BKLED ⁻	2.2 μ F 1206 X7R 25V	2.2 μ F 1206 X7R 50V	24V to 32V	350mA	4.75k	16.9k	950k	14.0k	1.1M
3V to 3.8V	Connect to BSTIN/BKLED ⁻	1 μ F 1206 X7R 10V	2.2 μ F 1206 X7R 10V	4V to 6V	500mA	7.32k	27.4k	650k	16.9k	950k
3.3V to 5.7V	Connect to BSTIN/BKLED ⁻	1 μ F 1206 X7R 10V	2.2 μ F 1206 X7R 10V	6V to 9V	500mA	7.32k	24.9k	700k	16.9k	950k
4V to 7.2V	Connect to BSTIN/BKLED ⁻	1 μ F 1206 X7R 10V	2.2 μ F 1206 X7R 16V	8V to 12V	500mA	7.32k	24.9k	700k	16.9k	950k
5.2V to 10.4V	Connect to BSTIN/BKLED ⁻	2.2 μ F 1206 X7R 16V	2.2 μ F 1206 X7R 16V	12V to 16V	500mA	7.32k	18.2k	900k	12.4k	1.2M
7V to 13V	Connect to BSTIN/BKLED ⁻	2.2 μ F 1206 X7R 16V	4.7 μ F 1206 X7R 25V	15V to 21V	500mA	7.32k	18.2k	900k	14.0k	1.1M
8.2V to 15.5V	Connect to BSTIN/BKLED ⁻	2.2 μ F 1206 X7R 16V	4.7 μ F 1206 X7R 25V	18V to 24V	500mA	7.32k	18.2k	900k	14.0k	1.1M
11.8V to 21.2V	Connect to BSTIN/BKLED ⁻	2.2 μ F 1206 X7R 25V	4.7 μ F 1206 X7R 50V	24V to 32V	500mA	7.32k	16.9k	950k	15.8k	1M
3.3V to 3.5V	Connect to BSTIN/BKLED ⁻	1 μ F 1206 X7R 10V4	4.7 μ F 1206 X7R 10V	4V to 6V	700mA	11.8k	27.4k	650k	16.9k	950k
4V to 5.8V	Connect to BSTIN/BKLED ⁻	1 μ F 1206 X7R 10V	4.7 μ F 1206 X7R 10V	6V to 9V	700mA	11.8k	24.9k	700k	21.0k	800k
5V to 7.6V	Connect to BSTIN/BKLED ⁻	1 μ F 1206 X7R 10V	4.7 μ F 1206 X7R 16V	8V to 12V	700mA	11.8k	24.9k	700k	22.6k	750k
7V to 11V	Connect to BSTIN/BKLED ⁻	2.2 μ F 1206 X7R 16V	4.7 μ F 1206 X7R 16V	12V to 16V	700mA	11.8k	18.2k	900k	16.9k	950k
9.5V to 13.5V	Connect to BSTIN/BKLED ⁻	2.2 μ F 1206 X7R 16V	4.7 μ F 1206 X7R 25V	15V to 21V	700mA	11.8k	18.2k	900k	16.9k	950k
11V to 16V	Connect to BSTIN/BKLED ⁻	2.2 μ F 1206 X7R 16V	4.7 μ F 1206 X7R 25V	18V to 24V	700mA	11.8k	18.2k	900k	16.9k	950k
16.5V to 21V	Connect to BSTIN/BKLED ⁻	2.2 μ F 1206 X7R 25V	4.7 μ F 1206 X7R 50V	24V to 32V	700mA	11.8k	16.9k	950k	15.8k	1M
5V to 5.8V	Connect to BSTIN/BKLED ⁻	1 μ F 1206 X7R 10V	4.7 μ F 1206 X7R 10V	6V to 9V	1A	Open	30.1k	600k	22.6k	750k
6.4V to 7.7V	Connect to BSTIN/BKLED ⁻	1 μ F 1206 X7R 10V	4.7 μ F 1206 X7R 16V	8V to 12V	1A	Open	30.1k	600k	24.9k	700k
8.6V to 11.3V	Connect to BSTIN/BKLED ⁻	2.2 μ F 1206 X7R 16V	4.7 μ F 1206 X7R 16V	12V to 16V	1A	Open	24.9k	700k	22.6k	750k
11.3V to 13.8V	Connect to BSTIN/BKLED ⁻	2.2 μ F 1206 X7R 16V	4.7 μ F 1206 X7R 25V	15V to 21V	1A	Open	21.0k	800k	19.6k	850k
13.4V to 16.5V	Connect to BSTIN/BKLED ⁻	4.7 μ F 1206 X7R 25V	4.7 μ F 1206 X7R 25V	18V to 24V	1A	Open	27.4k	650k	24.9k	700k
20.5V to 22.5V	Connect to BSTIN/BKLED ⁻	4.7 μ F 1206 X7R 25V	4.7 μ F 1206 X7R 50V	24V to 32V	1A	Open	33.2k	550k	30.1k	600k

APPLICATIONS INFORMATION

Table 2. LTM8042 Recommended Values and Configuration for Buck Mode ($T_A = 25^\circ\text{C}$)

V_{IN} RANGE (BSTOUT/BKIN)	V_{CC}	CV_{CC}	C_{IN} (BSTOUT/BKIN TO GND)	C_{OUT} (BSTOUT/BKIN TO BSTIN/BKLED ⁻)	LED STRING VOLTAGE (LED ⁺ TO BSTIN/ BKLED ⁻)	LED STRING CURRENT	R_{CTL}	RT (OPTI- MAL)	f (OPTI- MAL)	RT (MIN)	f (MAX)
4.4V to 5.5V	3V to 30V	1 μ F 0805 X7R 50V	1 μ F 1206 X7R 50V	2.2 μ F 1206 X7R 10V	2V to 4V	35mA	523	86.6k	250k	86.6k	250k
6.8V to 14V	3V to 30V	1 μ F 0805 X7R 50V	1 μ F 1206 X7R 50V	2.2 μ F 1206 X7R 10V	4V to 6V	35mA	523	86.6k	250k	86.6k	250k
9.6V to 26V	3V to 30V	1 μ F 0805 X7R 50V	1 μ F 1206 X7R 50V	2.2 μ F 1206 X7R 16V	6V to 9V	35mA	523	86.6k	250k	86.6k	250k
12.5V to 33V	3V to 30V	1 μ F 0805 X7R 50V	1 μ F 1206 X7R 50V	2.2 μ F 1210 X7R 16V	8V to 12V	35mA	523	86.6k	250k	86.6k	250k
16.6V to 33V	3V to 30V	1 μ F 0805 X7R 50V	1 μ F 1206 X7R 50V	2.2 μ F 1210 X7R 25V	12V to 16V	35mA	523	86.6k	250k	46.4k	420k
21.8V to 33V	3V to 30V	1 μ F 0805 X7R 50V	1 μ F 1206 X7R 50V	2.2 μ F 1210 X7R 25V	15V to 21V	35mA	523	86.6k	250k	33.2k	550k
24.5V to 33V	3V to 30V	1 μ F 0805 X7R 50V	1 μ F 1206 X7R 50V	2.2 μ F 1210 X7R 25V	18V to 24V	35mA	523	86.6k	250k	26.1k	670k
4.5V to 21V	3V to 30V	1 μ F 0805 X7R 50V	1 μ F 1206 X7R 50V	4.7 μ F 1206 X7R 10V	2V to 4V	100mA	1.30k	86.6k	250k	86.6k	250k
6.8V to 33.8V	3V to 30V	1 μ F 0805 X7R 50V	1 μ F 1206 X7R 50V	4.7 μ F 1206 X7R 10V	4V to 6V	100mA	1.30k	86.6k	250k	86.6k	250k
9.9V to 33.5V	3V to 30V	1 μ F 0805 X7R 50V	1 μ F 1206 X7R 50V	4.7 μ F 1210 X7R 16V	6V to 9V	100mA	1.30k	76.8k	275k	69.8k	300k
13V to 33.4V	3V to 30V	1 μ F 0805 X7R 50V	1 μ F 1206 X7R 50V	4.7 μ F 1210 X7R 16V	8V to 12V	100mA	1.30k	69.8k	300k	48.7k	400k
17.2V to 33.1V	3V to 30V	1 μ F 0805 X7R 50V	1 μ F 1206 X7R 50V	4.7 μ F 1210 X7R 25V	12V to 16V	100mA	1.30k	37.4k	500k	31.6k	575k
23V to 33V	3V to 30V	1 μ F 0805 X7R 50V	1 μ F 1206 X7R 50V	4.7 μ F 1210 X7R 25V	15V to 21V	100mA	1.30k	24.9k	700k	19.1k	870k
26V to 33V	3V to 30V	1 μ F 0805 X7R 50V	1 μ F 1206 X7R 50V	4.7 μ F 1210 X7R 25V	18V to 24V	100mA	1.30k	21.0k	800k	12.4k	1.2M
5.2V to 33.6V	3V to 30V	1 μ F 0805 X7R 50V	1 μ F 1206 X7R 50V	4.7 μ F 1206 X7R 10V	2V to 4V	350mA	4.75k	61.9k	330k	54.9k	365k
7V to 33.4V	3V to 30V	1 μ F 0805 X7R 50V	1 μ F 1206 X7R 50V	4.7 μ F 1206 X7R 10V	4V to 6V	350mA	4.75k	30.1k	600k	24.9k	700k
10.5V to 33.3V	3V to 30V	1 μ F 0805 X7R 50V	1 μ F 1206 X7R 50V	4.7 μ F 1210 X7R 16V	6V to 9V	350mA	4.75k	21.0k	800k	15.8k	1M
14.5V to 33.2V	3V to 30V	1 μ F 0805 X7R 50V	1 μ F 1206 X7R 50V	4.7 μ F 1210 X7R 16V	8V to 12V	350mA	4.75k	12.4k	1.2M	8.25k	1.6M
19.2V to 33V	3V to 30V	1 μ F 0805 X7R 50V	1 μ F 1206 X7R 50V	4.7 μ F 1210 X7R 25V	12V to 16V	350mA	4.75k	11.0k	1.3M	3.74k	2.5M
25V to 33V	3V to 30V	1 μ F 0805 X7R 50V	1 μ F 1206 X7R 50V	4.7 μ F 1210 X7R 25V	15V to 21V	350mA	4.75k	11.0k	1.3M	3.74k	2.5M
4.9V to 33V	3V to 30V	1 μ F 0805 X7R 50V	1 μ F 1206 X7R 50V	4.7 μ F 1206 X7R 10V	2V to 4V	500mA	7.32k	37.4k	500k	33.2k	550k
7.3V to 33.2V	3V to 30V	1 μ F 0805 X7R 50V	1 μ F 1206 X7R 50V	4.7 μ F 1206 X7R 10V	4V to 6V	500mA	7.32k	21.0k	800k	18.2k	900k
10.7V to 33V	3V to 30V	1 μ F 0805 X7R 50V	1 μ F 1206 X7R 50V	4.7 μ F 1210 X7R 16V	6V to 9V	500mA	7.32k	15.8k	1M	11.0k	1.3M
14.1V to 32.8V	3V to 30V	1 μ F 0805 X7R 50V	1 μ F 1206 X7R 50V	4.7 μ F 1210 X7R 16V	8V to 12V	500mA	7.32k	15.8k	1M	7.50k	1.7M
18.5V to 32.5V	3V to 30V	1 μ F 0805 X7R 50V	1 μ F 1206 X7R 50V	4.7 μ F 1210 X7R 25V	12V to 16V	500mA	7.32k	15.8k	1M	3.74k	2.5M
24.3V to 32.5V	3V to 30V	1 μ F 0805 X7R 50V	1 μ F 1206 X7R 50V	4.7 μ F 1210 X7R 25V	15V to 21V	500mA	7.32k	15.8k	1M	3.74k	2.5M
5V to 33.2V	3V to 30V	1 μ F 0805 X7R 50V	1 μ F 1206 X7R 50V	4.7 μ F 1206 X7R 10V	2V to 4V	700mA	11.8k	33.2k	550k	30.1k	600k
7.3V to 32.7V	3V to 30V	1 μ F 0805 X7R 50V	1 μ F 1206 X7R 50V	4.7 μ F 1206 X7R 10V	4V to 6V	700mA	11.8k	21.0k	800k	18.2k	900k
10.8V to 32.7V	3V to 30V	1 μ F 0805 X7R 50V	1 μ F 1206 X7R 50V	4.7 μ F 1210 X7R 16V	6V to 9V	700mA	11.8k	15.8k	1M	11.0k	1.3M
14.4V to 32.2V	3V to 30V	1 μ F 0805 X7R 50V	1 μ F 1206 X7R 50V	4.7 μ F 1210 X7R 16V	8V to 12V	700mA	11.8k	15.8k	1M	7.50k	1.7M
18.8V to 31.7V	3V to 30V	1 μ F 0805 X7R 50V	1 μ F 1206 X7R 50V	4.7 μ F 1210 X7R 25V	12V to 16V	700mA	11.8k	15.8k	1M	3.74k	2.5M
24.3V to 31.8V	3V to 30V	1 μ F 0805 X7R 50V	1 μ F 1206 X7R 50V	4.7 μ F 1210 X7R 25V	15V to 21V	700mA	11.8k	15.8k	1M	3.74k	2.5M
5V to 32V	3V to 30V	1 μ F 0805 X7R 50V	2.2 μ F 1206 X7R 50V	4.7 μ F 1206 X7R 10V	2V to 4V	1A	Open	33.2k	550k	30.1k	600k
7.2V to 32V	3V to 30V	1 μ F 0805 X7R 50V	2.2 μ F 1206 X7R 50V	4.7 μ F 1206 X7R 10V	4V to 6V	1A	Open	21.0k	800k	16.9k	950k
10.8V to 31V	3V to 30V	1 μ F 0805 X7R 50V	2.2 μ F 1206 X7R 50V	4.7 μ F 1210 X7R 16V	6V to 9V	1A	Open	15.8k	1M	11.0k	1.3M
14.3V to 30.5V	3V to 30V	1 μ F 0805 X7R 50V	2.2 μ F 1206 X7R 50V	4.7 μ F 1210 X7R 16V	8V to 12V	1A	Open	15.8k	1M	7.50k	1.7M
18.9V to 30.5V	3V to 30V	1 μ F 0805 X7R 50V	2.2 μ F 1206 X7R 50V	4.7 μ F 1210 X7R 25V	12V to 16V	1A	Open	15.8k	1M	3.74k	2.5M
24.6V to 30.5V	3V to 30V	1 μ F 0805 X7R 50V	2.2 μ F 1206 X7R 50V	4.7 μ F 1210 X7R 25V	15V to 21V	1A	Open	15.8k	1M	3.74k	2.5M

APPLICATIONS INFORMATION

Table 3. LTM8042 Recommended Values and Configuration for Buck-Boost Mode ($T_A = 25^\circ\text{C}$)

V_{IN} RANGE (BSTIN/ BKLED ⁻)	V_{CC}	C_{VCC} (V_{CC} to GND)	C_{IN} (BSTIN/BKLED ⁻ TO GND)	C_{OUT1} (BSTOUT/BKIN TO BSTIN/ BKLED ⁻)	C_{OUT2} (BSTOUT/BKIN TO GND)	LED STRING VOLTAGE (LED ⁺ to BSTIN/ BKLED ⁻)	LED STRING CURR- ENT	R_{CTL}	RT (OPTI- MAL)	f (OPTI- MAL)	RT (MIN)	f (MAX)
3V to 6V	3V to 30V	1 μ F 0805 X7R 50V	1 μ F 0805 X7R 10V	1 μ F 0805 X7R 10V	1 μ F 0805 X7R 10V	2V to 4V	35mA	523	86.6k	250k	86.6k	250k
3V to 14V	3V to 30V	1 μ F 0805 X7R 50V	1 μ F 0805 X7R 16V	1 μ F 0805 X7R 10V	1 μ F 0805 X7R 10V	4V to 6V	35mA	523	86.6k	250k	86.6k	250k
3V to 20V	3V to 30V	1 μ F 0805 X7R 50V	1 μ F 1206 X7R 25V	1 μ F 0805 X7R 10V	1 μ F 0805 X7R 10V	6V to 9V	35mA	523	86.6k	250k	86.6k	250k
3V to 21V	3V to 30V	1 μ F 0805 X7R 50V	1 μ F 1206 X7R 25V	1 μ F 0805 X7R 16V	1 μ F 0805 X7R 16V	8V to 12V	35mA	523	86.6k	250k	57.6k	350k
3V to 17.8V	3V to 30V	1 μ F 0805 X7R 50V	1 μ F 1206 X7R 25V	1 μ F 0805 X7R 16V	1 μ F 1206 X7R 25V	12V to 16V	35mA	523	48.7k	400k	27.4k	650k
3V to 13V	3V to 30V	1 μ F 0805 X7R 50V	1 μ F 0805 X7R 16V	1 μ F 1206 X7R 25V	1 μ F 1206 X7R 25V	15V to 21V	35mA	523	37.4k	500k	10.0k	1.4M
3.5V to 10.1V	3V to 30V	1 μ F 0805 X7R 50V	1 μ F 0805 X7R 16V	1 μ F 1206 X7R 25V	1 μ F 1206 X7R 25V	18V to 24V	35mA	523	22.6k	750k	3.74k	2.5M
3V to 21V	3V to 30V	1 μ F 0805 X7R 50V	1 μ F 1206 X7R 25V	2.2 μ F 1206 X7R 10V	1 μ F 0805 X7R 10V	2V to 4V	100mA	1.30k	86.6k	250k	69.8k	300k
3V to 22.8V	3V to 30V	1 μ F 0805 X7R 50V	1 μ F 1206 X7R 25V	1 μ F 0805 X7R 10V	1 μ F 0805 X7R 10V	4V to 6V	100mA	1.30k	48.7k	400k	43.2k	450k
3V to 23.4V	3V to 30V	1 μ F 0805 X7R 50V	1 μ F 1206 X7R 25V	1 μ F 0805 X7R 10V	1 μ F 0805 X7R 10V	6V to 9V	100mA	1.30k	37.4k	500k	30.1k	600k
3V to 21.8V	3V to 30V	1 μ F 0805 X7R 50V	1 μ F 1206 X7R 25V	1 μ F 0805 X7R 16V	1 μ F 1206 X7R 25V	8V to 12V	100mA	1.30k	21.0k	800k	16.9k	950k
3V to 17.9V	3V to 30V	1 μ F 0805 X7R 50V	1 μ F 1206 X7R 25V	1 μ F 0805 X7R 16V	1 μ F 1206 X7R 25V	12V to 16V	100mA	1.30k	19.6k	850k	11.0k	1.3M
3V to 12.6V	3V to 30V	1 μ F 0805 X7R 50V	1 μ F 0805 X7R 16V	1 μ F 1206 X7R 25V	1 μ F 1206 X7R 25V	15V to 21V	100mA	1.30k	19.6k	850k	4.02k	2.4M
3.7V to 9.7V	3V to 30V	1 μ F 0805 X7R 50V	1 μ F 0805 X7R 10V	1 μ F 1206 X7R 25V	1 μ F 1206 X7R 25V	18V to 24V	100mA	1.30k	19.6k	850k	3.74k	2.5M
3V to 28V	3V to 30V	1 μ F 0805 X7R 50V	1 μ F 1206 X7R 50V	2.2 μ F 1206 X7R 10V	1 μ F 0805 X7R 10V	2V to 4V	350mA	4.75k	43.2k	450k	37.4k	500k
3V to 27.5V	3V to 30V	1 μ F 0805 X7R 50V	1 μ F 1206 X7R 50V	2.2 μ F 1206 X7R 10V	1 μ F 0805 X7R 10V	4V to 6V	350mA	4.75k	33.2k	550k	24.9k	700k
4.5V to 24.5V	3V to 30V	1 μ F 0805 X7R 50V	1 μ F 1206 X7R 25V	2.2 μ F 1206 X7R 10V	1 μ F 0805 X7R 10V	6V to 9V	350mA	4.75k	24.9k	700k	10.7k	1.35M
5.5V to 20.7V	3V to 30V	1 μ F 0805 X7R 50V	1 μ F 1206 X7R 25V	2.2 μ F 1206 X7R 16V	1 μ F 1206 X7R 25V	8V to 12V	350mA	4.75k	15.8k	1M	6.19k	1.9M
7V to 17.1V	3V to 30V	1 μ F 0805 X7R 50V	1 μ F 1206 X7R 25V	2.2 μ F 1206 X7R 16V	1 μ F 1206 X7R 25V	12V to 16V	350mA	4.75k	15.8k	1M	3.74k	2.5M
8.2V to 11.4V	3V to 30V	1 μ F 0805 X7R 50V	1 μ F 0805 X7R 16V	4.7 μ F 1210 X7R 25V	1 μ F 1206 X7R 25V	15V to 21V	350mA	4.75k	18.2k	900k	3.74k	2.5M
3V to 23V	3V to 30V	1 μ F 0805 X7R 50V	1 μ F 1206 X7R 25V	2.2 μ F 1206 X7R 10V	1 μ F 0805 X7R 10V	2V to 4V	500mA	7.32k	27.4k	650k	24.9k	700k
4.5V to 27V	3V to 30V	1 μ F 0805 X7R 50V	1 μ F 1206 X7R 50V	2.2 μ F 1206 X7R 10V	1 μ F 0805 X7R 10V	4V to 6V	500mA	7.32k	21.0k	800k	19.6k	850k
6V to 24V	3V to 30V	1 μ F 0805 X7R 50V	1 μ F 1206 X7R 25V	2.2 μ F 1206 X7R 10V	1 μ F 0805 X7R 10V	6V to 9V	500mA	7.32k	15.8k	1M	10.0k	1.4M
7.3V to 20.3V	3V to 30V	1 μ F 0805 X7R 50V	1 μ F 1206 X7R 25V	2.2 μ F 1206 X7R 16V	1 μ F 1206 X7R 25V	8V to 12V	500mA	7.32k	15.8k	1M	6.34k	1.85M
9.4V to 15V	3V to 30V	1 μ F 0805 X7R 50V	1 μ F 0805 X7R 16V	2.2 μ F 1206 X7R 16V	1 μ F 1206 X7R 25V	12V to 16V	500mA	7.32k	15.8k	1M	3.74k	2.5M
4.2V to 23.8V	3V to 30V	1 μ F 0805 X7R 50V	2.2 μ F 1206 X7R 25V	2.2 μ F 1206 X7R 10V	1 μ F 0805 X7R 10V	2V to 4V	700mA	11.8k	24.9k	700k	22.6k	750k
4.7V to 27V	3V to 30V	1 μ F 0805 X7R 50V	2.2 μ F 1206 X7R 50V	2.2 μ F 1206 X7R 10V	1 μ F 0805 X7R 10V	4V to 6V	700mA	11.8k	16.9k	950k	15.8k	1M
6.1V to 23V	3V to 30V	1 μ F 0805 X7R 50V	2.2 μ F 1206 X7R 25V	2.2 μ F 1206 X7R 10V	1 μ F 0805 X7R 10V	6V to 9V	700mA	11.8k	16.9k	950k	9.09k	1.5M
7.3V to 20V	3V to 30V	1 μ F 0805 X7R 50V	2.2 μ F 1206 X7R 25V	2.2 μ F 1206 X7R 16V	1 μ F 1206 X7R 25V	8V to 12V	700mA	11.8k	16.9k	950k	6.19k	1.9M
10.5V to 16.5V	3V to 30V	1 μ F 0805 X7R 50V	2.2 μ F 1206 X7R 25V	4.7 μ F 1210 X7R 16V	1 μ F 1206 X7R 25V	12V to 16V	700mA	11.8k	15.8k	1M	3.74k	2.5M
4.7V to 28.5V	3V to 30V	1 μ F 0805 X7R 50V	2.2 μ F 1206 X7R 50V	4.7 μ F 1206 X7R 10V	1 μ F 0805 X7R 10V	2V to 4V	1A	Open	24.9k	700k	22.6k	750k
6.7V to 26.8V	3V to 30V	1 μ F 0805 X7R 50V	2.2 μ F 1206 X7R 50V	4.7 μ F 1206 X7R 10V	1 μ F 0805 X7R 10V	4V to 6V	1A	Open	22.6k	750k	16.9k	950k
9V to 23.5V	3V to 30V	1 μ F 0805 X7R 50V	4.7 μ F 1210 X7R 25V	4.7 μ F 1206 X7R 10V	1 μ F 0805 X7R 10V	6V to 9V	1A	Open	22.6k	750k	10.0k	1.4M
13.5V to 20V	3V to 30V	1 μ F 0805 X7R 50V	4.7 μ F 1210 X7R 25V	4.7 μ F 1210 X7R 16V	1 μ F 1206 X7R 25V	8V to 12V	1A	Open	22.6k	750k	5.76k	2M

APPLICATIONS INFORMATION

Table 4. LTM8042-1 Recommended Values and Configuration for Boost ($T_A = 25^\circ\text{C}$)

V_{IN} RANGE (BSTIN/ BKLED ⁻)	V_{CC}	C_{IN} (BSTIN/BKLED ⁻ TO GND)	C_{OUT} (BSTOUT/BKIN TO GND)	LED STRING VOLTAGE (LED ⁺ TO GND)	LED STRING CURRENT	R_{CTL}	RT (OPTI- MAL)	f (OPTI- MAL)	RT (MIN)	f (MAX)
1V to 3.3V	3V to 30V	1 μ F 0805 X7R 10V	1 μ F 0805 X7R 10V	4V to 6V	35mA	1.27k	86.6k	250k	69.8k	300k
1.2V to 5V	3V to 30V	1 μ F 0805 X7R 10V	1 μ F 0805 X7R 10V	6V to 9V	35mA	1.27k	76.8k	275k	61.9k	330k
1.6V to 6V	3V to 30V	1 μ F 0805 X7R 10V	1 μ F 0805 X7R 16V	8V to 12V	35mA	1.27k	69.8k	300k	57.6k	350k
2.2V to 9.2V	3V to 30V	1 μ F 0805 X7R 10V	1 μ F 0805 X7R 16V	12V to 16V	35mA	1.27k	48.7k	400k	37.4k	500k
2.7V to 10V	3V to 30V	1 μ F 0805 X7R 16V	1 μ F 0805 X7R 25V	15V to 21V	35mA	1.27k	37.4k	500k	30.1k	600k
3V to 12.8V	Connect to BSTIN/BKLED ⁻	1 μ F 0805 X7R 16V	1 μ F 0805 X7R 25V	18V to 24V	35mA	1.27k	33.2k	550k	27.4k	650k
3.7V to 14.7V	Connect to BSTIN/BKLED ⁻	1 μ F 0805 X7R 16V	1 μ F 0805 X7R 50V	24V to 32V	35mA	1.27k	33.2k	550k	27.4k	650k
1.1V to 3.8V	3V to 30V	1 μ F 0805 X7R 10V	2.2 μ F 1206 X7R 10V	4V to 6V	100mA	3.40k	86.6k	250k	37.4k	500k
1.5V to 5.6V	3V to 30V	1 μ F 0805 X7R 16V	2.2 μ F 1206 X7R 10V	6V to 9V	100mA	3.40k	76.8k	275k	37.4k	500k
2.4V to 7.1V	3V to 30V	2.2 μ F 1206 X7R 10V	2.2 μ F 1206 X7R 16V	8V to 12V	100mA	3.40k	69.8k	300k	37.4k	500k
3.1V to 10.4V	Connect to BSTIN/BKLED ⁻	2.2 μ F 1206 X7R 16V	2.2 μ F 1206 X7R 16V	12V to 16V	100mA	3.40k	48.7k	400k	30.1k	600k
4V to 12V	Connect to BSTIN/BKLED ⁻	2.2 μ F 1206 X7R 16V	2.2 μ F 1206 X7R 25V	15V to 21V	100mA	3.40k	37.4k	500k	30.1k	600k
4.9V to 14.9V	Connect to BSTIN/BKLED ⁻	1 μ F 0805 X7R 16V	2.2 μ F 1206 X7R 25V	18V to 24V	100mA	3.40k	30.1k	600k	24.9k	700k
6.1V to 18.8V	Connect to BSTIN/BKLED ⁻	1 μ F 0805 X7R 25V	2.2 μ F 1206 X7R 50V	24V to 32V	100mA	3.40k	24.9k	700k	21.0k	800k
2.4V to 3.8V	3V to 30V	1 μ F 0805 X7R 10V	4.7 μ F 0805 X7R 10V	4V to 6V	350mA	19.6k	27.4k	650k	16.9k	950k
2.8V to 5.3V	3V to 30V	1 μ F 0805 X7R 10V	2.2 μ F 1206 X7R 10V	6V to 9V	350mA	19.6k	27.4k	650k	16.9k	950k
3.2V to 7V	Connect to BSTIN/BKLED ⁻	1 μ F 0805 X7R 10V	2.2 μ F 1206 X7R 16V	8V to 12V	350mA	19.6k	27.4k	650k	16.9k	950k
4.1V to 10V	Connect to BSTIN/BKLED ⁻	1 μ F 1206 X7R 10V	2.2 μ F 1206 X7R 16V	12V to 16V	350mA	19.6k	19.6k	850k	15.8k	1M
4.8V to 12.3V	Connect to BSTIN/BKLED ⁻	1 μ F 1206 X7R 16V	2.2 μ F 1206 X7R 25V	15V to 21V	350mA	19.6k	18.2k	900k	12.4k	1.2M
5.8V to 15V	Connect to BSTIN/BKLED ⁻	1 μ F 1206 X7R 16V	2.2 μ F 1206 X7R 25V	18V to 24V	350mA	19.6k	16.9k	950k	14.0k	1.1M
8.5V to 20.8V	Connect to BSTIN/BKLED ⁻	2.2 μ F 1206 X7R 25V	2.2 μ F 1206 X7R 50V	24V to 32V	350mA	19.6k	16.9k	950k	14.0k	1.1M

APPLICATIONS INFORMATION

Table 5. LTM8042-1 Recommended Values and Configuration for Buck Mode ($T_A = 25^\circ\text{C}$)

V_{IN} RANGE (BSTOUT/ BKIN)	V_{CC}	C_{VCC}	C_{IN} (BSTOUT/BKIN TO GND)	C_{OUT} (BSTOUT/BKIN TO BSTIN/BKLED ⁻)	LED STRING VOLTAGE (LED ⁺ TO BSTIN/ BKLED ⁻)	LED STRING CURRENT	R_{CTL}	R (OPTI- MAL)	f (OPTI- MAL)	R_T (MIN)	f (MAX)
4.3V to 8.3V	3V to 30V	1 μ F 0805 X7R 50V	1 μ F 1206 X7R 50V	2.2 μ F 1206 X7R 10V	2V to 4V	35mA	1.27k	86.6k	250k	86.6k	250k
6.6V to 20V	3V to 30V	1 μ F 0805 X7R 50V	1 μ F 1206 X7R 50V	2.2 μ F 1206 X7R 10V	4V to 6V	35mA	1.27k	86.6k	250k	86.6k	250k
9.5V to 31.5V	3V to 30V	1 μ F 0805 X7R 50V	1 μ F 1206 X7R 50V	2.2 μ F 1206 X7R 16V	6V to 9V	35mA	1.27k	86.6k	250k	86.6k	250k
12.5V to 33V	3V to 30V	1 μ F 0805 X7R 50V	1 μ F 1206 X7R 50V	2.2 μ F 1210 X7R 16V	8V to 12V	35mA	1.27k	86.6k	250k	86.6k	250k
16.6V to 33.2V	3V to 30V	1 μ F 0805 X7R 50V	1 μ F 1206 X7R 50V	2.2 μ F 1210 X7R 25V	12V to 16V	35mA	1.27k	86.6k	250k	46.4k	420k
21.8V to 33.6V	3V to 30V	1 μ F 0805 X7R 50V	1 μ F 1206 X7R 50V	2.2 μ F 1210 X7R 25V	15V to 21V	35mA	1.27k	86.6k	250k	33.2k	550k
24.4V to 33.1V	3V to 30V	1 μ F 0805 X7R 50V	1 μ F 1206 X7R 50V	2.2 μ F 1210 X7R 25V	18V to 24V	35mA	1.27k	86.6k	250k	26.1k	670k
4.3V to 19.5V	3V to 30V	1 μ F 0805 X7R 50V	1 μ F 1206 X7R 50V	4.7 μ F 1206 X7R 10V	2V to 4V	100mA	3.40k	86.6k	250k	86.6k	250k
6.5V to 33.8V	3V to 30V	1 μ F 0805 X7R 50V	1 μ F 1206 X7R 50V	4.7 μ F 1206 X7R 10V	4V to 6V	100mA	3.40k	86.6k	250k	86.6k	250k
9.6V to 34.5V	3V to 30V	1 μ F 0805 X7R 50V	1 μ F 1206 X7R 50V	4.7 μ F 1210 X7R 16V	6V to 9V	100mA	3.40k	76.8k	275k	57.6k	350k
12.6V to 34.4V	3V to 30V	1 μ F 0805 X7R 50V	1 μ F 1206 X7R 50V	4.7 μ F 1210 X7R 16V	8V to 12V	100mA	3.40k	69.8k	300k	48.7k	400k
17V to 34.5V	3V to 30V	1 μ F 0805 X7R 50V	1 μ F 1206 X7R 50V	4.7 μ F 1210 X7R 25V	12V to 16V	100mA	3.40k	37.4k	500k	31.6k	575k
22.8V to 34.5V	3V to 30V	1 μ F 0805 X7R 50V	1 μ F 1206 X7R 50V	4.7 μ F 1210 X7R 25V	15V to 21V	100mA	3.40k	24.9k	700k	19.1k	870k
26.2V to 34.4V	3V to 30V	1 μ F 0805 X7R 50V	1 μ F 1206 X7R 50V	4.7 μ F 1210 X7R 25V	18V to 24V	100mA	3.40k	21.0k	800k	12.4k	1.2M
4.6V to 34.3V	3V to 30V	1 μ F 0805 X7R 50V	1 μ F 1206 X7R 50V	4.7 μ F 1206 X7R 10V	2V to 4V	350mA	19.6k	61.9k	330k	54.9k	365k
6.7V to 34.3V	3V to 30V	1 μ F 0805 X7R 50V	1 μ F 1206 X7R 50V	4.7 μ F 1206 X7R 10V	4V to 6V	350mA	19.6k	30.1k	600k	24.9k	700k
10.3V to 34.3V	3V to 30V	1 μ F 0805 X7R 50V	1 μ F 1206 X7R 50V	4.7 μ F 1210 X7R 16V	6V to 9V	350mA	19.6k	21.0k	800k	15.8k	1M
13.7V to 34.5V	3V to 30V	1 μ F 0805 X7R 50V	1 μ F 1206 X7R 50V	4.7 μ F 1210 X7R 16V	8V to 12V	350mA	19.6k	19.6k	850k	8.25k	1.6M
18.6V to 34.6V	3V to 30V	1 μ F 0805 X7R 50V	1 μ F 1206 X7R 50V	4.7 μ F 1210 X7R 25V	12V to 16V	350mA	19.6k	14.0k	1.1M	3.74k	2.5M
24.1V to 34.3V	3V to 30V	1 μ F 0805 X7R 50V	1 μ F 1206 X7R 50V	4.7 μ F 1210 X7R 25V	15V to 21V	350mA	19.6k	15.8k	1M	3.74k	2.5M
27.3V to 32.8V	3V to 30V	1 μ F 0805 X7R 50V	1 μ F 1206 X7R 50V	4.7 μ F 1210 X7R 25V	18V to 24V	350mA	19.6k	15.8k	1M	3.74k	2.5M

APPLICATIONS INFORMATION

Table 6. LTM8042-1 Recommended Values and Configuration for Buck-Boost Mode ($T_A = 25^\circ\text{C}$)

V_{IN} RANGE (BSTIN/ BKLED ⁻)	V_{CC}	$C_{V_{CC}}$ (V_{CC} TO GND)	C_{IN} (BSTIN/BKLED ⁻ TO GND)	C_{OUT1} (BSTOUT/BKIN TO BSTIN/ BKLED ⁻)	C_{OUT2} (BSTOUT/BKIN TO GND)	LED STRING VOLTAGE (LED ⁺ TO BSTIN/ BKLED ⁻)	LED STRING CUR- RENT	R_{CTL}	RT (OPTI- MAL)	f (OPTI- MAL)	RT (MIN)	f (MAX)
1V to 9.5V	3V to 30V	1 μ F 0805 X7R 50V	1 μ F 0805 X7R 10V	1 μ F 0805 X7R 10V	1 μ F 0805 X7R 10V	2V to 4V	35mA	1.27k	86.6k	250k	86.6k	250k
1.1V to 21V	3V to 30V	1 μ F 0805 X7R 50V	1 μ F 0805 X7R 16V	1 μ F 0805 X7R 10V	1 μ F 0805 X7R 10V	4V to 6V	35mA	1.27k	86.6k	250k	86.6k	250k
1.3V to 24V	3V to 30V	1 μ F 0805 X7R 50V	1 μ F 1206 X7R 25V	1 μ F 0805 X7R 10V	1 μ F 0805 X7R 10V	6V to 9V	35mA	1.27k	86.6k	250k	86.6k	250k
1.5V to 20.8V	3V to 30V	1 μ F 0805 X7R 50V	1 μ F 1206 X7R 25V	1 μ F 0805 X7R 16V	1 μ F 0805 X7R 16V	8V to 12V	35mA	1.27k	86.6k	250k	43.2k	450k
2.2V to 16.9V	3V to 30V	1 μ F 0805 X7R 50V	1 μ F 1206 X7R 25V	1 μ F 0805 X7R 16V	1 μ F 1206 X7R 25V	12V to 16V	35mA	1.27k	48.7k	400k	30.1k	600k
3V to 12V	3V to 30V	1 μ F 0805 X7R 50V	1 μ F 1206 X7R 25V	1 μ F 1206 X7R 25V	1 μ F 1206 X7R 25V	15V to 21V	35mA	1.27k	37.4k	500k	10.0k	1.4M
3.8V to 9V	3V to 30V	1 μ F 0805 X7R 50V	1 μ F 1206 X7R 25V	1 μ F 1206 X7R 25V	1 μ F 1206 X7R 25V	18V to 24V	35mA	1.27k	22.6k	750k	3.74k	2.5M
1.1V to 24V	3V to 30V	1 μ F 0805 X7R 50V	1 μ F 1206 X7R 25V	2.2 μ F 1206 X7R 10V	1 μ F 0805 X7R 10V	2V to 4V	100mA	3.40k	86.6k	250k	69.8k	300k
1.3V to 27V	3V to 30V	1 μ F 0805 X7R 50V	1 μ F 1206 X7R 25V	1 μ F 0805 X7R 10V	1 μ F 0805 X7R 10V	4V to 6V	100mA	3.40k	48.7k	400k	43.2k	450k
1.6V to 24V	3V to 30V	1 μ F 0805 X7R 50V	1 μ F 1206 X7R 25V	1 μ F 0805 X7R 10V	1 μ F 0805 X7R 10V	6V to 9V	100mA	3.40k	37.4k	500k	33.2k	550k
1.9V to 21.5V	3V to 30V	1 μ F 0805 X7R 50V	1 μ F 1206 X7R 25V	1 μ F 0805 X7R 16V	1 μ F 0805 X7R 16V	8V to 12V	100mA	3.40k	21.0k	800k	19.6k	850k
2.5V to 17V	3V to 30V	1 μ F 0805 X7R 50V	1 μ F 1206 X7R 25V	1 μ F 0805 X7R 16V	1 μ F 1206 X7R 25V	12V to 16V	100mA	3.40k	19.6k	850k	8.25k	1.6M
3V to 12V	3V to 30V	1 μ F 0805 X7R 50V	1 μ F 0805 X7R 16V	1 μ F 1206 X7R 25V	1 μ F 1206 X7R 25V	15V to 21V	100mA	3.40k	19.6k	850k	3.74k	2.5M
3.7V to 9V	3V to 30V	1 μ F 0805 X7R 50V	1 μ F 0805 X7R 10V	1 μ F 1206 X7R 25V	1 μ F 1206 X7R 25V	18V to 24V	100mA	3.40k	15.8k	1M	3.74k	2.5M
2.2V to 29V	3V to 30V	1 μ F 0805 X7R 50V	1 μ F 1206 X7R 50V	2.2 μ F 1206 X7R 10V	1 μ F 0805 X7R 10V	2V to 4V	350mA	19.6k	43.2k	450k	37.4k	500k
2.7V to 27.5V	3V to 30V	1 μ F 0805 X7R 50V	1 μ F 1206 X7R 50V	2.2 μ F 1206 X7R 10V	1 μ F 0805 X7R 10V	4V to 6V	350mA	19.6k	27.4k	650k	18.2k	900k
3.7V to 23.8V	3V to 30V	1 μ F 0805 X7R 50V	1 μ F 1206 X7R 25V	2.2 μ F 1206 X7R 10V	1 μ F 0805 X7R 10V	6V to 9V	350mA	19.6k	18.2k	900k	9.09k	1.5M
3.8V to 20.2V	3V to 30V	1 μ F 0805 X7R 50V	1 μ F 1206 X7R 25V	2.2 μ F 1206 X7R 16V	1 μ F 0805 X7R 16V	8V to 12V	350mA	19.6k	14.0k	1.1M	6.19k	1.9M
5.3V to 15.2V	3V to 30V	1 μ F 0805 X7R 50V	1 μ F 1206 X7R 25V	2.2 μ F 1206 X7R 16V	1 μ F 1206 X7R 25V	12V to 16V	350mA	19.6k	14.0k	1.1M	3.74k	2.5M
7.4V to 9.3V	3V to 30V	1 μ F 0805 X7R 50V	1 μ F 0805 X7R 16V	2.2 μ F 1206 X7R 16V	1 μ F 1206 X7R 25V	15V to 21V	350mA	19.6k	18.2k	900k	3.74k	2.5M

APPLICATIONS INFORMATION

Thermal Considerations

The LTM8042/LTM8042-1 output current may need to be derated if it is required to operate in a high ambient temperature or deliver a large amount of continuous power. The amount of current derating is dependent upon the input voltage, output power and ambient temperature. The temperature rise curves given in the Typical Performance Characteristics section can be used as a guide. These curves were generated by an LTM8042/LTM8042-1 mounted to a 51cm² 4-layer FR4 printed circuit board. Boards of other sizes and layer count can exhibit different thermal behavior, so it is incumbent upon the user to verify proper operation over the intended system's line, load and environmental operating conditions.

The thermal resistance numbers listed in the Pin Configuration section of the data sheet are based on modeling the μ Module package mounted on a test board specified per JESD51-9 ("Test Boards for Area Array Surface Mount Package Thermal Measurements"). The thermal coefficients provided are based on JESD 51-12 ("Guidelines for Reporting and Using Electronic Package Thermal Information").

For increased accuracy and fidelity to the actual application, many designers use finite element analysis (FEA) to predict thermal performance. To that end, the Pin Configuration section of the data sheet typically gives four thermal coefficients:

1. θ_{JA} : thermal resistance from junction to ambient.
2. $\theta_{JCBOTTOM}$: thermal resistance from junction to the bottom of the product case.
3. θ_{JCTOP} : thermal resistance from junction to top of the product case.
4. θ_{JB} : thermal resistance from junction to the printed circuit board.

While the meaning of each of these coefficients may seem to be intuitive, JEDEC has defined each to avoid confusion and inconsistency. These definitions are given in JESD 51-12, and are quoted or paraphrased in the following:

1. θ_{JA} is the natural convection junction-to-ambient air thermal resistance measured in a one cubic foot sealed enclosure. This environment is sometimes referred to as "still air" although natural convection causes the air to move. This value is determined with the part mounted to a JESD 51-9 defined test board, which does not reflect an actual application or viable operating condition.
2. $\theta_{JCBOTTOM}$ is the junction-to-board thermal resistance with all of the component power dissipation flowing through the bottom of the package. In the typical μ Module regulator, the bulk of the heat flows out the bottom of the package, but there is always heat flow out into the ambient environment. As a result, this thermal resistance value may be useful for comparing packages but the test conditions don't generally match the user's application.
3. θ_{JCTOP} is determined with nearly all of the component power dissipation flowing through the top of the package. As the electrical connections of the typical μ Module regulator are on the bottom of the package, it is rare for an application to operate such that most of the heat flows from the junction to the top of the part. As in the case of $\theta_{JCBOTTOM}$, this value may be useful for comparing packages but the test conditions don't generally match the user's application.
4. θ_{JB} is the junction-to-board thermal resistance where almost all of the heat flows through the bottom of the μ Module regulator and into the board, and is really the sum of the $\theta_{JCBOTTOM}$ and the thermal resistance of the bottom of the part through the solder joints and through a portion of the board. The board temperature is measured a specified distance from the package, using a two sided, two layer board. This board is described in JESD 51-9.

APPLICATIONS INFORMATION

The most appropriate way to use the coefficients is when running a detailed thermal analysis, such as FEA, which considers all of the thermal resistances simultaneously. None of them can be individually used to accurately predict the thermal performance of the product, so it would be inappropriate to attempt to use any one coefficient to correlate to the junction temperature versus load graphs given in the LTM8042/LTM8042-1 data sheet.

A graphical representation of these thermal resistances is given in Figure 5.

The blue resistances are contained within the μ Module regulator, and the green are outside.

The die temperature of the LTM8042/LTM8042-1 must be lower than the maximum rating of 125°C, so care should be taken in the layout of the circuit to ensure good heat sinking of the LTM8042/LTM8042-1. The bulk of the heat flow out of the LTM8042/LTM8042-1 is through the bottom of the module and the LGA pads into the printed circuit board. Consequently, a poor printed circuit board design can cause excessive heating, resulting in impaired performance or reliability. Please refer to the PCB Layout section for printed circuit board design suggestions.

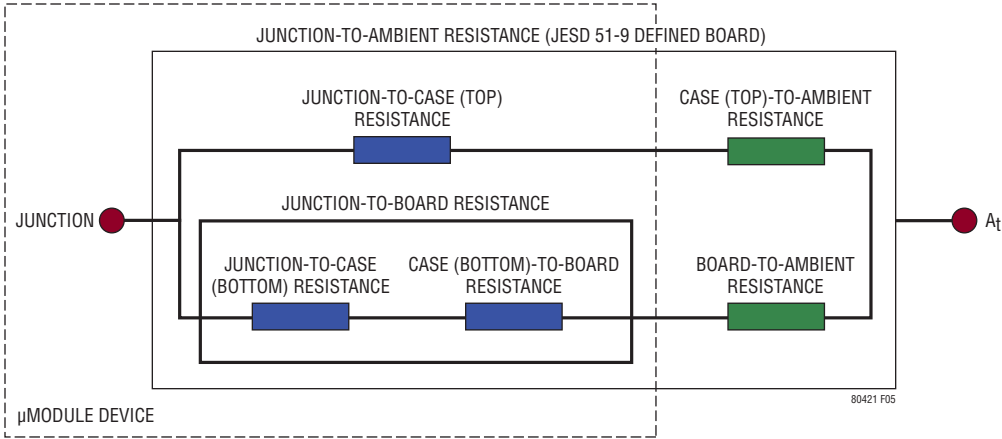
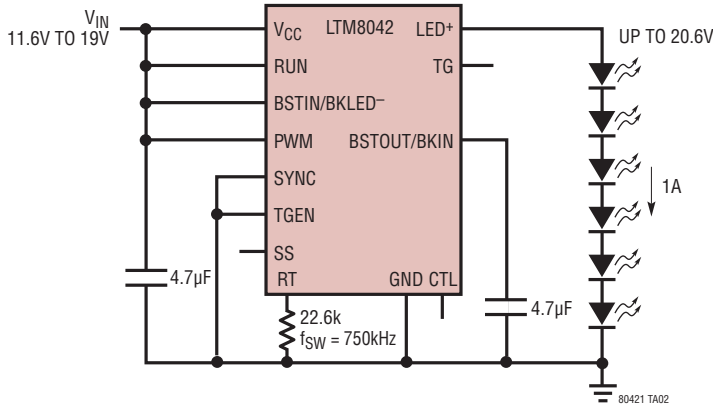

Figure 5

TYPICAL APPLICATIONS

Boost Operation, Driving 6 White LEDs at 1A



TYPICAL APPLICATIONS

Buck-Boost Mode, Driving 5 White LEDs at 500mA with PWM Dimming

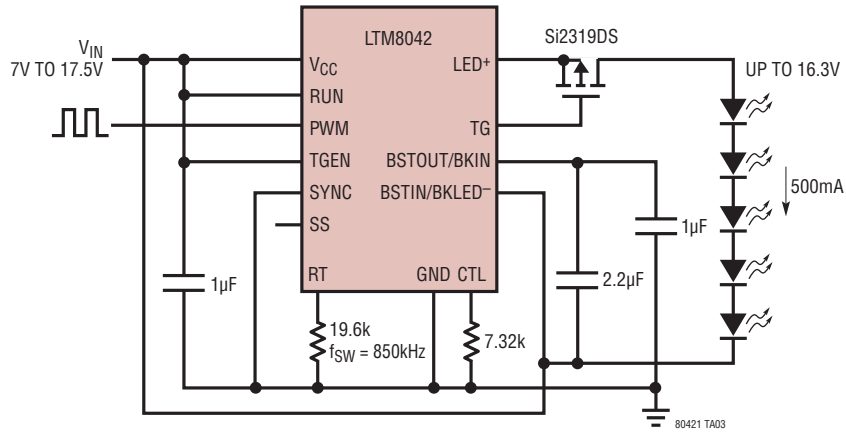

Buck Mode, Driving 4 White LEDs at 1A

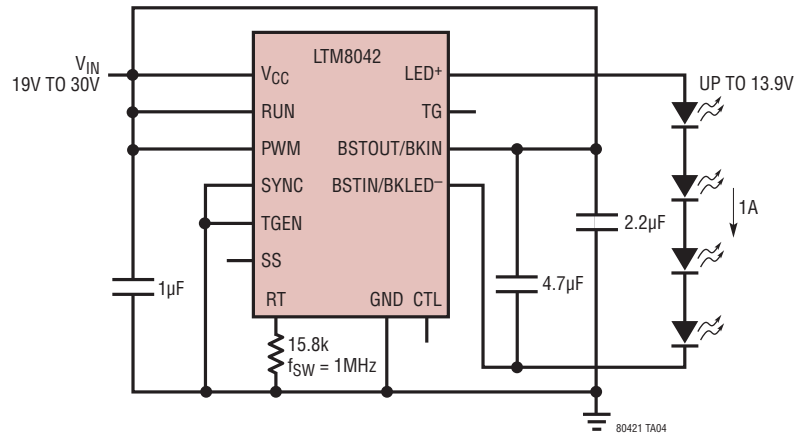

Boost Operation, Driving 9 White LEDs at 100mA

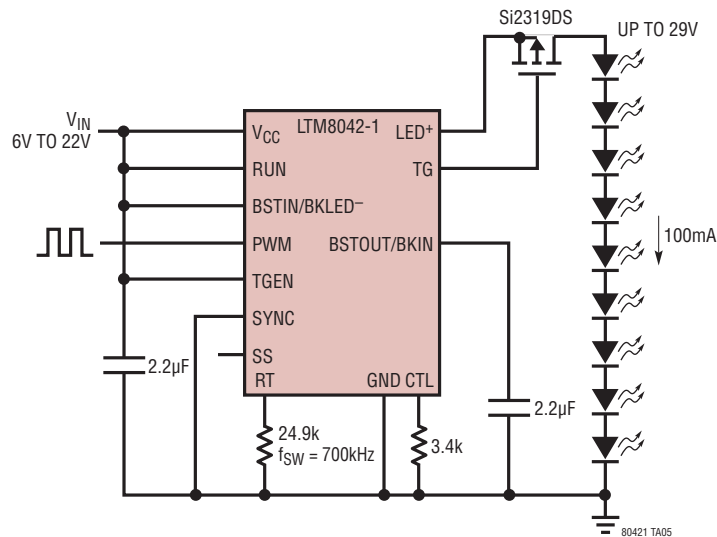

PACKAGE DESCRIPTION

Pin Assignment Table
(Arranged by Pin Number)

PIN	NAME	PIN	NAME	PIN	NAME	PIN	NAME	PIN	NAME	PIN	NAME
A1	GND	B1	GND	C1	GND	D1	GND	E1	GND	F1	RUN
A2	GND	B2	GND	C2	GND	D2	GND	E2	GND	F2	GND
A3	GND	B3	GND	C3	GND	D3	GND	E3	GND	F3	GND
A4	GND	B4	GND	C4	GND	D4	GND	E4	GND	F4	GND
A5	GND	B5	GND	C5	BSTIN/BKLED-	D5	BSTIN/BKLED-	E5	GND	F5	GND
A6	V _{CC}	B6	V _{CC}	C6	BSTIN/BKLED-	D6	BSTIN/BKLED-	E6	GND	F6	GND
A7	V _{CC}	B7	V _{CC}	C7	BSTIN/BKLED-	D7	BSTIN/BKLED-	E7	GND	F7	GND

PIN	NAME	PIN	NAME	PIN	NAME	PIN	NAME	PIN	NAME
G1	SYNC	H1	RT	J1	SS	K1	PWM	L1	GND
G2	GND	H2	GND	J2	GND	K2	GND	L2	CTL
G3	GND	H3	GND	J3	GND	K3	GND	L3	TGEN
G4	GND	H4	GND	J4	GND	K4	GND	L4	GND
G5	BSTOUT/BKIN	H5	BSTOUT/BKIN	J5	BSTOUT/BKIN	K5	LED+	L5	LED+
G6	BSTOUT/BKIN	H6	BSTOUT/BKIN	J6	BSTOUT/BKIN	K6	LED+	L6	LED+
G7	BSTOUT/BKIN	H7	BSTOUT/BKIN	J7	TG	K7	LED+	L7	LED+

PACKAGE PHOTOGRAPH

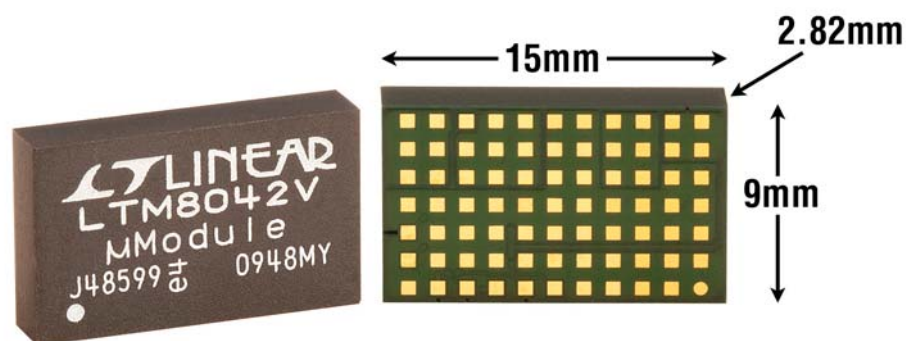

PACKAGE DESCRIPTION

LGA Package
77-Lead (15mm × 9mm × 2.82mm)
 (Reference LTC DWG # 05-08-1859 Rev.0)

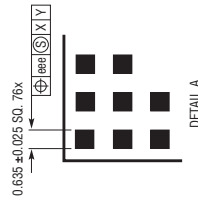
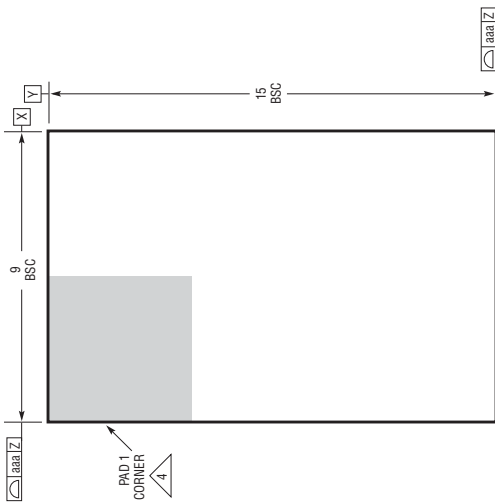
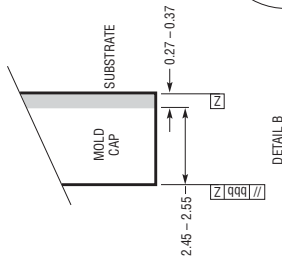
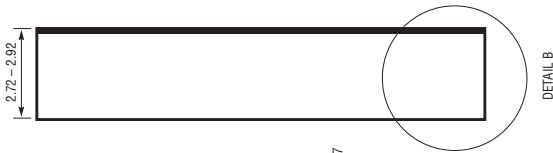
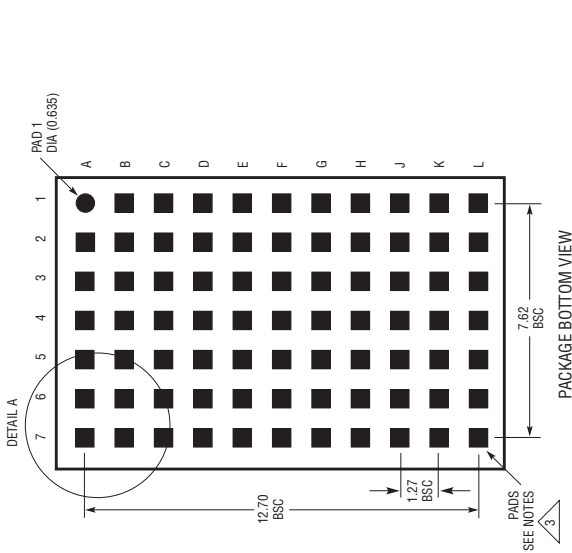

- NOTES:
1. DIMENSIONING AND TOLERANCING PER ASME Y14.5M-1994
 2. ALL DIMENSIONS ARE IN MILLIMETERS
 3. LAND DESIGNATION PER JEDEC MO-222, SPP-010
 4. DETAILS OF PAD #1 IDENTIFIER ARE OPTIONAL, BUT MUST BE LOCATED WITHIN THE ZONE INDICATED. THE PAD #1 IDENTIFIER MAY BE EITHER A MOLD OR MARKED FEATURE
 5. PRIMARY DATUM - Z - IS SEATING PLANE
 6. THE TOTAL NUMBER OF PADS: 77

SYMBOL	TOLERANCE
aaa	0.15
bbb	0.10
eee	0.05

PACKAGE TOP VIEW

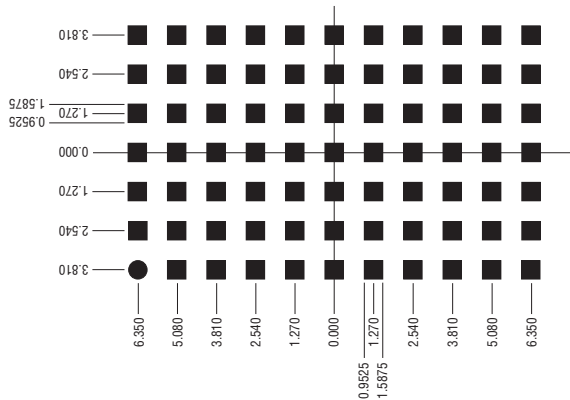

SUGGESTED PCB LAYOUT TOP VIEW

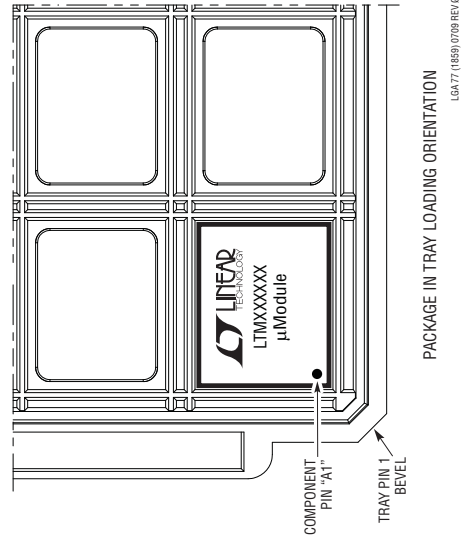

PACKAGE IN TRAY LOADING ORIENTATION
 LGA77 (1859) 07/09 REV.0

REVISION HISTORY

REV	DATE	DESCRIPTION	PAGE NUMBER
A	01/11	Updated features.	1
		Updated I_{LED} conditions in the Electrical Characteristics section.	3
		Updated text in the Operation section.	15
		Updated text in the Setting the Switching Frequency section.	16

TYPICAL APPLICATION

Boost Operation, Driving 9 Red LEDs at 350mA with Analog Dimming

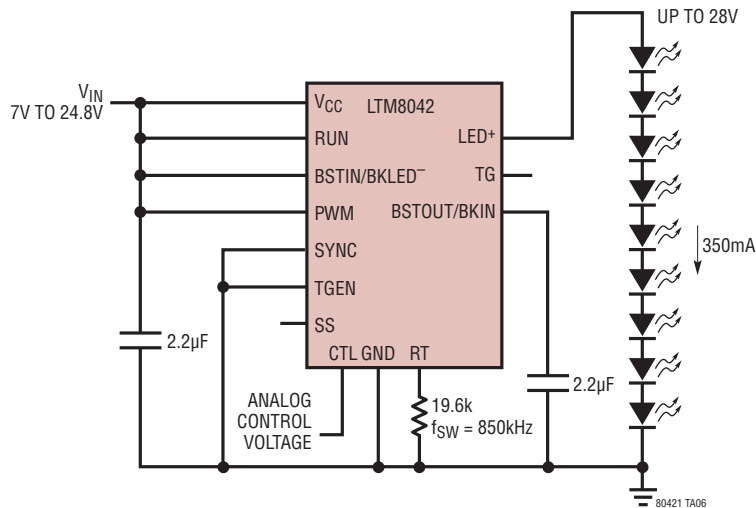

RELATED PARTS

PART NUMBER	DESCRIPTION	COMMENTS
LTM8040	36V, 1A, µModule LED Driver and Current Source	$4V \leq V_{IN} \leq 36V$; Open LED and Short-Circuit Protection, 9mm × 15mm × 4.32mm LGA Package
LTM8032	EMC 36V, 2A, µModule Regulator	EN55022 Class B Compliant; $0.8V \leq V_{OUT} \leq 10V$
LTM4607	Buck-Boost µModule Regulator	$4.5V \leq V_{IN} \leq 36V$; $0.8V \leq V_{OUT} \leq 25V$, 15mm × 15mm × 2.8mm