



## 20 NUMBER ONE TOUCH DIALLER WITH SERIAL BUS FOR DISPLAY DRIVER

### Key Features

- Low operating voltage (2.5V to 5.5V)
- Low current consumption (typ. 200  $\mu$ A in LD mode)
- Oscillator using ceramic resonator (681 kHz)
- MF level independent of supply voltage
- Direct 'wake-up' from keyboard
- Automatic Call Progress by direct memory key
- Data protection with 8 digit FIFO
- Sliding cursor protocol with comparison
- Diode options for different PTT requirements
- Automatic pause generation after access code
- Temporary MF select via keyboard
- 36 digit LNR (Last Number Redial)
- 20 memories addressable with direct keys and the **2nd** key or indirect with a **MEM** key
- Notepad
- Serial interface to display driver AS2590
- Consistent, simple and useable procedures
- Input for dial tone recognizer

### General Description

The AS2574B is an integrated CMOS device for feature telephones. It is a very versatile LD/MF dialler with serial interface to a display driver. The device is designed to be used in a wide variety of applications together with the companion display driver, AS2590.

The on chip RAM can contain up to 20 memories (each with maximum 18 digits), a 36 digit Last Number Redial (LNR) and an 18 digit notepad. Access to the 20 memories is either with direct keys, abbreviated dial code or a combination of both. The AS2574B provides a unique feature, Automatic Call Progress (ACP), on all memory keys, i.e. the circuit automatically seizes the line and waits for the dial tone and dials the number just by pressing any of the memory keys (including LNR).

The circuit features 2 different access code procedures to allow easy use under a PABX. A dial tone input enables the use of a dial tone recognizer.

### Application

High feature telephone sets.

### Package

Available in 28 pin DIP and PLCC.

*Direct wake-up is an AMS patented solution providing line seizing with a telephone, that is entirely powered from the telephone line, by pressing a key in a key matrix connected to a dialler/controller that is constantly connected to the line by means of a line voltage limiter and yet maintaining a high dc isolation resistance in idle state (on-hook).*

*The wake-up feature allows the user to go off-hook by pressing a direct memory key or a loudspeaker key, so-called on-hook dialling or call progress monitoring, and thereby seize the line.*

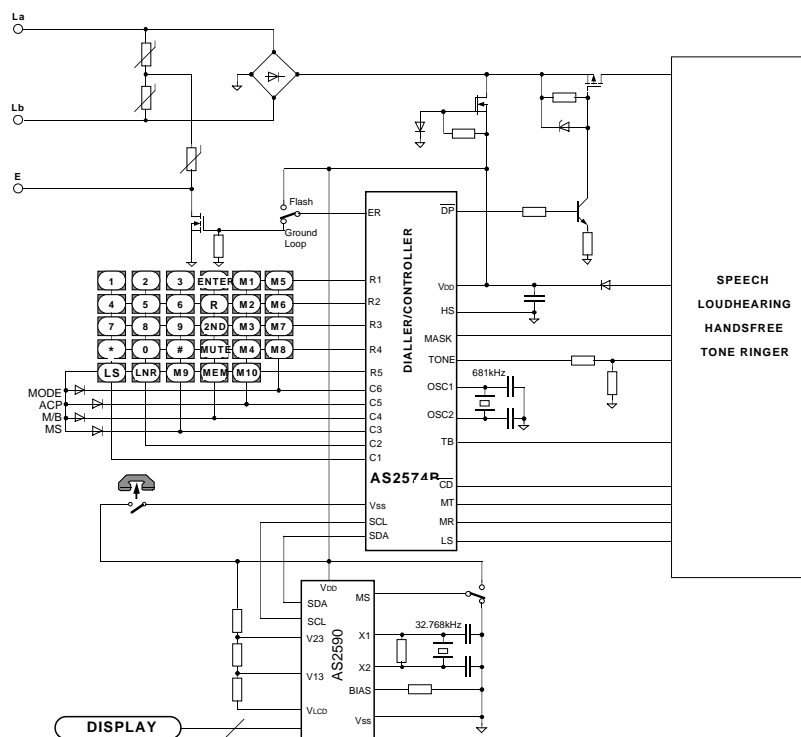

Pin Description

Pin #	Pin Node	Description								
1 2	OSC2 OSC1	Oscillator pins for ceramic resonator (681 kHz)								
3 4	SCL SDA	The SCL output is used to clock all data into the display driver The SDA output is used to transfer data into the display driver								
5 - 10 11 - 15	C1 - 6 R1 - 5	Keyboard columns Keyboard rows								
16	LS	Output for controlling loudhearing and handsfree facilities, active high (see hook state diagramme)								
17	MASK	Mask output, active high during pulsing (make and break period, see timing diagrammes).								
18	$\overline{CD}$	Chip disable input, active low. When $\overline{CD}$ is low, the circiut is disabled. If this pin is pulled to $V_{SS}$ during Off-hook (indicating a disconnect) for more than 2 sec., the circuit is reset*. If the pin is pulled to $V_{SS}$ for less than 2 sec., the line break is ignored. * If in ACP or monitor state, reset also means return to idle state.								
19 20	MR MT	Mute output, active high during signalling (see timing diagrammes). Transmit mute output, active high when MR is high and when the <b>Mute</b> key has been activated (see timing diagrammes).								
21	ER	Earth recall input/output, active high during ER but when forced to $V_{DD}$ , the flash is enabled.								
22	DT	Dial tone input. This input is scanned when invoking ACP or a pause is read in a digit string: <table border="1" style="margin-left: 40px;"> <thead> <tr> <th>DT pin</th> <th>Function</th> </tr> </thead> <tbody> <tr> <td>Open</td> <td>Pause duration 4.1 sec</td> </tr> <tr> <td>Low</td> <td>If a high is not detected within 8 sec., the circuit is reset *</td> </tr> <tr> <td>High</td> <td>If the pin is high for &gt; 1.15 sec., the pause is terminated and the dialling continued. Noise immunity &gt; 8 ms</td> </tr> </tbody> </table> * Reset means that dialling is stopped and the circuit returns to standby. If the circuit was in ACP state, the reset will also return the circuit to idle state.	DT pin	Function	Open	Pause duration 4.1 sec	Low	If a high is not detected within 8 sec., the circuit is reset *	High	If the pin is high for > 1.15 sec., the pause is terminated and the dialling continued. Noise immunity > 8 ms
DT pin	Function									
Open	Pause duration 4.1 sec									
Low	If a high is not detected within 8 sec., the circuit is reset *									
High	If the pin is high for > 1.15 sec., the pause is terminated and the dialling continued. Noise immunity > 8 ms									
23	$\overline{DP}$	Hook switch control, dial pulse and flash output; low during Idle and break periods and high during off-hook (see timing diagrammes).								

Continues...

Pin Description Continued

Pin #	Pin Node	Description																				
24	HS	Hook switch input; active high with internal pull-down resistor. Debounce 25 ms.																				
25	Vss	Negative terminal of power supply.																				
26	TB	Tone burst output: <table border="1" style="margin-left: 20px;"> <tr> <td>LS high</td> <td>80 ms burst, 8 sec pause</td> </tr> <tr> <td>MT high</td> <td>80 ms burst, 2 sec pause</td> </tr> <tr> <td>MT+LS high</td> <td>80 ms burst, 2 sec pause</td> </tr> </table> Only in speech mode	LS high	80 ms burst, 8 sec pause	MT high	80 ms burst, 2 sec pause	MT+LS high	80 ms burst, 2 sec pause														
LS high	80 ms burst, 8 sec pause																					
MT high	80 ms burst, 2 sec pause																					
MT+LS high	80 ms burst, 2 sec pause																					
27	TONE	MF tone output. An on chip reference voltage provides tone levels independent of the supply voltage. A dc path from TONE output is needed to accommodate an external voltage divider for setting the appropriate tone level. Frequencies: <table border="1" style="margin-left: 20px;"> <thead> <tr> <th>Frequency (Hz)</th> <th>Key Matrix (Hz)</th> <th>Error (%)</th> </tr> </thead> <tbody> <tr><td>697</td><td>row 1</td><td rowspan="8">≤ ± 0.7%</td></tr> <tr><td>770</td><td>row 2</td></tr> <tr><td>852</td><td>row 3</td></tr> <tr><td>941</td><td>row 4</td></tr> <tr><td>1209</td><td>col. 1</td></tr> <tr><td>1336</td><td>col. 2</td></tr> <tr><td>1477</td><td>col. 3</td></tr> <tr><td>1633</td><td>see p. 7</td></tr> </tbody> </table>	Frequency (Hz)	Key Matrix (Hz)	Error (%)	697	row 1	≤ ± 0.7%	770	row 2	852	row 3	941	row 4	1209	col. 1	1336	col. 2	1477	col. 3	1633	see p. 7
Frequency (Hz)	Key Matrix (Hz)	Error (%)																				
697	row 1	≤ ± 0.7%																				
770	row 2																					
852	row 3																					
941	row 4																					
1209	col. 1																					
1336	col. 2																					
1477	col. 3																					
1633	see p. 7																					
28	Vdd	Positive terminal of power supply																				

Keyboard Layout

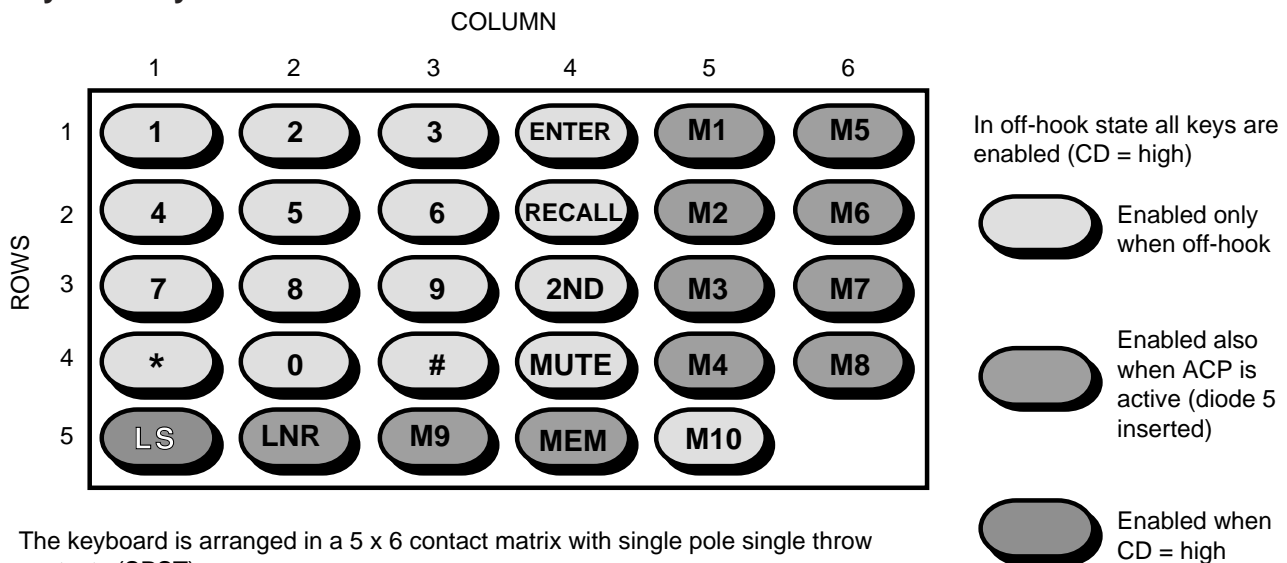

The keyboard is arranged in a 5 x 6 contact matrix with single pole single throw contacts (SPST).  
 Keyboard resistance: Ron < 5 kΩ; Roff > 5 MΩ.

### Power On Reset

The on chip analogue power on reset circuit monitors the supply voltage ( $V_{DD}$ ). As long as  $V_{DD}$  remains below the internal reference voltage,  $V_{REF}$  (typically 1.2V), the oscillator is inhibited. When  $V_{DD}$  rises above  $V_{REF}$ , a reset signal is generated to assure correct start-up, and the oscillator is enabled.

The correct start-up/reset condition of the circuit is guaranteed regardless of the absolute and chronological rise time of  $V_{DD}$ , CD and HS inputs.

### Line Supervision

In off-hook condition the device performs supervision of the line current disconnects in the following manner:

Line disconnects (CD low) of less than 2 sec. are ignored and the device continues operation.

Line disconnects of more than 2 sec. cause stop of dialling and the circuit is switched to standby mode if HS is high, otherwise the circuit will return to idle mode.

### Valid Keys

A valid key is detected from the keyboard by connecting the appropriate row to the column. This can be done using an  $n \times m$  keyboard matrix with single contacts. Positive and negative edges of each contact are debounced. The debounce time is 15 ms.

In idle state (on-hook) only the **LS** key is always valid independent of the CD pin. When diode 5 is connected, also the **LNR**, **MEM**, and **M1 - 9** keys are valid entries invoking ACP (automatic call progress).

### Mute Key

Depressing the **Mute** key activates and deactivates (toggle switch) the MT output, when internal mute is inactive, i.e. when no data is being read from the RAM or FIFO.

A change of the hook state will release the mute.

### Mode Selection

The default mode (LD or MF) can be selected by the diode option mode (diode 6).

When default LD mode is selected, a temporary change to MF mode can be invoked by pressing the \* key.

When the circuit is in temporary MF mode, each of the

following procedures revert it to default LD mode:

- pressing **R** key (all subsequently entered digits are buffered in FIFO),
- by next On-hook.

### Last Number Redial

LNR is a facility that allows resignalling of the last manually dialled number without keying in all the digits again. The LNR is repeatable.

A manually entered number is automatically stored in the LNR RAM. The capacity of the RAM is 36 digits. If a number greater than 36 digits is entered, the LNR facility will be inhibited (until new entries < 37 digits) and further entries will be buffered in FIFO. If more than 18 digits are entered, the display will show the digit 19 and onwards.

Postdialled digits, i.e. digits manually entered after LNR has been invoked, are not stored in RAM but buffered in FIFO.

The current contents of the LNR RAM are overwritten by new entries.

### Memory Dial

An on chip RAM enables the dialler to store up to 20 numbers, each containing a maximum 18 digits/data.

The first 10 memories are accessible with 10 Direct dial keys (**M1** to **M10**) and another 10 memories (11 - 20) are accessible by pressing the **2nd** key before one of the Direct dial keys or by pressing the **MEM** key and a digit 0 - 9 (abbreviated dialling).

Basic store procedure:

- 1 Press **Enter** key
- 2 Key in digits, including access code, pauses and recall as appropriate (number is stored in LNR RAM)
- 3 Select location by keeping **Enter** key depressed while entering the desired location (**M1...M10**, **2nd M1...M10**, or **MEM 0...9**)
- 4 Release **Enter** key to finish
- 5 Continue with 1, 2, 3 and 4 for storing further numbers.

Only the first 18 digits/data will be stored when copying more than 18 digits/data in a memory.

### Recall Function

A recall activation will invoke a flash (timed loop break) or an earth recall (ER) depending on the ER pin. When the ER pin is forced to  $V_{DD}$ , a flash is executed; and when ER is open ( $> 50 \text{ k}\Omega$ ), an earth recall is executed.

If **R** is the first entry in a digit string, it will be stored in LNR RAM.

If the **R** key is depressed after a digit string has been dialled out, the recall will not be stored, and subsequently entered digits will be buffered in the FIFO.

A recall will automatically generate a pause when a recall is read from a memory and therecall has been stored as an access code.

A manual invoked earth recall will pull ER high for minimum 500 ms, but the ER pin is maintained high as long as the key is depressed.

During auto dial an earth recall is executed with a duration of 500 ms.

### Access Codes

Different access codes (totally up to 18 digit/data including spaces) can be stored in one string. Spaces between the different access codes are entered by pressing the **2nd #** during programming. Each access code can contain up to 4 digits.

If one or more access codes are stored, the first entered digit(s) in a digit string read from the RAM will be compared with the access code(s) and if equal, a pause is generated.

Example on programming access codes:

**ENTER, 9, 2nd #, 50**

Keep **ENTER** depressed while pressing **0**

Release both

The first access code in this example is 9 and the second 50.

### Pause Generation

Pause introduces a delay in signalling digits strings to accommodate second and subsequent dial tones.

Automatic pauses are generated:

- during dialling out from memories when the first digit(s) in the digit string equal the stored access code(s) (pause depends on DT input).
- when going Off-hook by pressing **LNR**, **MEM**, or **M1 - 9** (ACP).

Any pause can be terminated (shortened) prior to time out by pressing the **LNR** key or a high level on the DT input.

During ACP a pause time out, i.e. DT kept low for  $> 8$  sec., will return the device to idle state.

Pauses are storable as digits within a string of any of the memories by pressing **2nd #** during programming. Multiple pause entries can be stored up to the maximum length of the digit string (18 digits/data). A pause is not accepted in location 1 of a digit string.

If more pauses have been stored in succession, they can all be terminated by one depression of the **LNR** key or a high level on the DT pin for  $\geq 1.15$  sec.

### Sliding Cursor Procedure

To accommodate redialling (LNR) behind a PABX without using automatic pause generation (storing access codes), a sliding cursor protocol is implemented. If new entries match the previous LNR RAM contents, pressing the **LNR** key will dial out the remaining digits.

If there is an error in matching, the LNR will be inhibited until next On-hook, and the LNR RAM will contain the new number.

**Serial Interface**

The AS2574B supports a serial bus. The protocol defines device that sends data onto the bus as a transmitter, and the receiving device as the receiver. The AS2574B is controlling the transfer and hence the master. The display driver, AS2590, being controlled is the slave.

low. SDA state changes during SCL high are reserved for indicating start and stop conditions (see figure 1).

**Start Condition**

All commands are preceded by the start condition, which is a high to low transition of SDA when SCL is high.

**Stop Condition**

All communications are terminated by a stop condition, which is low to high transition of SDA when SCL is high.

**Clock and Data Conventions**

Data states on the SDA line can change only during SCL

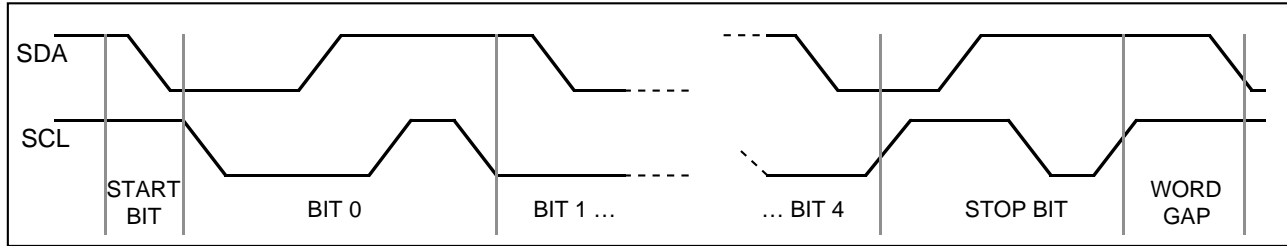

Figure 1: Data Transmission

No	Symbol/command	MSB	B3	B2	B1	LSB	HEX
1	0	1	1	1	0	0	1C
2	1	0	0	0	0	0	00
3	2	0	0	1	0	0	04
4	3	0	0	0	1	0	02
5	4	1	0	0	0	0	10
6	5	1	0	1	0	0	14
7	6	1	0	0	1	0	12
8	7	0	1	0	0	0	08
9	8	0	1	1	0	0	0C
10	9	0	1	0	1	0	0A
11	a	0	0	1	1	0	06
12	b	1	0	1	1	0	16
13	c	0	1	1	1	0	0E
14	d	1	1	1	1	0	1E
15	*	1	1	0	0	0	18
16	#	1	1	0	1	0	1A
17	Pause	1	1	0	1	1	1B
18	Temporary MF select	1	1	0	0	1	19
19	Recall	0	0	0	0	1	01
20	LS on	0	0	1	0	1	05
21	LS off	0	0	0	1	1	03
22	MT on	1	0	0	0	1	11
23	MT off	0	1	0	0	1	09
24	2nd on	0	0	1	1	1	07
25	2nd off	1	1	1	1	1	1F
26	Set Clock	0	1	0	1	1	0B
27	Start	0	1	1	0	1	0D
28	Start copy	0	1	1	1	1	0F
29	Start FIFO	1	0	0	1	1	13
30	Start timer	1	0	1	0	1	15
31	Blank all	1	1	1	0	1	1D
32	Test mode	1	0	1	1	1	17

## Key Combinations

Key/KeyCombination	Function	Remarks
ENTER	Programming	
R	Flash or ground loop	Code no 19
MEM	Abbreviated dialling	
MUTE	Privacy mute	Code no 22/23
LS	Monitor/Handsfree	Code no 20/21
LNR	Last Number Redial	During execution of a pause the LNR key is used to terminate the pause.
M1 - 10	Direct memory keys	
2nd	Second functions	Code no 24
2nd, 1	a	Code no 11
2nd, 2	b	Code no 12
2nd, 3	c	Code no 13
2nd, 4	d	Code no 14
2nd, *	Enter FIFO	Code no 29
2nd, #	Pause	Code no 17
2nd, M1 - 10	Memories 11 - 20	
MEM, 0 - 9	Memories 11 - 20	
ENTER, Address*	Displaying content of Memo	
ENTER/Address*	Programming	Code no 28 when both keys are released
ENTER/#	Setting clock	Code no 26
2nd, 5 - 9	5 - 9	Code no 6 - 10
2nd, 0	0	Code no 1
2nd, R	RECALL	Code no 19
2nd, MUTE	Privacy MUTE	Code no 22/23
ENTER/LNR	Clearing LNR	Code no 27
ENTER, ENTER	Displaying Access code	Code no 27

\*) Address means **M1 - 10** keys or **2nd, M1 - 10** or **MEM, 0 - 9** key combinations.

Diode Options

Option	Column	Function	No diode	diode
NoP	1	Number of Pulses Digit 1 2 3 4 5 6 7 8 9 0	Standard 1 2 3 4 5 6 7 8 9 10	NZ 9 8 7 6 5 4 3 2 1 10
FT	2	Flash Time	101.2 ms	600 ms
MS	3	Memory Size	10	20
M/B	4	Make/Break Ratio	33/66 ms	40/60 ms
ACP	5	Automatic Call Progress	no	yes
MODE	6	Default Signalling Mode	MF	LD

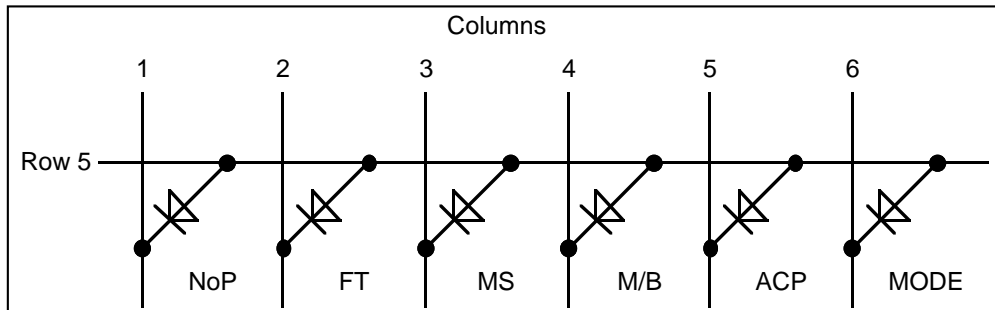

The diode options are scanned by POR and low to high transition on HS.

System Considerations

The device is intended to be used in telephone instruments, that are permanently on-line, i.e. also when on-hook the circuit is connected to the telephone line, but in standby mode (idle) and hence only drawing a small leakage current from the line.

This implementation offers new features like electronic hook switch and call progress monitoring (on-hook dialling).

Call progress monitoring (CPM) means pressing the **LS** key will switch the telephone on from standby (direct 'wake-up' from keyboard) and will present the dialling tones via a loudspeaker without lifting the handset.

Furthermore, it is also possible to invoke the CPM by pressing the **LNR**, **MEM** or **M1 - 9** when the ACP (Automatic Call Progress) is activated (diode 5).

Procedure Principles

The procedures for utilizing the features of the device are optimized out of consideration for the human factor in order to:

- meet the user's expectations
- be easy to learn and relearn
- not invoke any automatic functions which the user doesn't expect
- protect the user from committing critical errors, e.g. dialling wrong numbers, deleting stored numbers, etc.
- be consistent, simple and usable.



Symbols

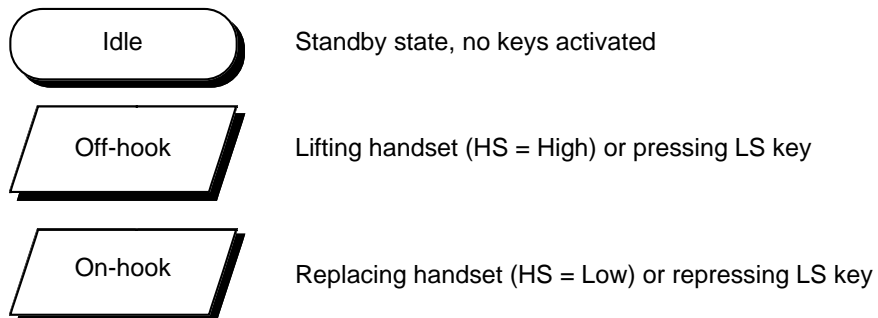

Manual Dial

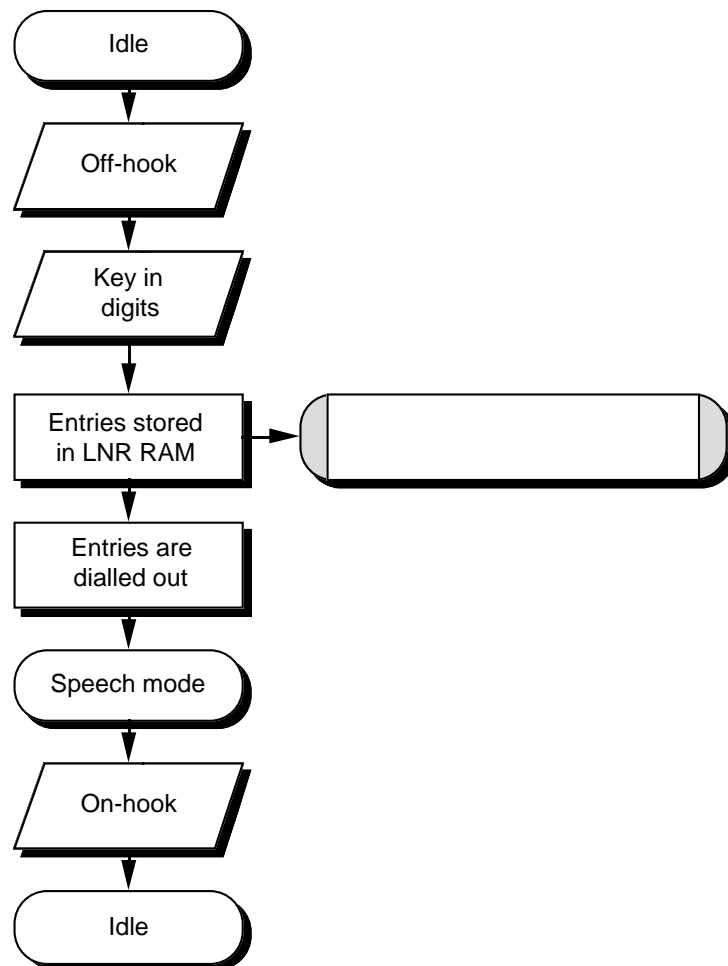

The last manually dialled number is automatically stored in the LNR RAM.  
In LD mode \* invokes temporary MF mode and # are ignored.  
In MF mode \* and # are automatically stored in LNR RAM.

Programming/Notepad

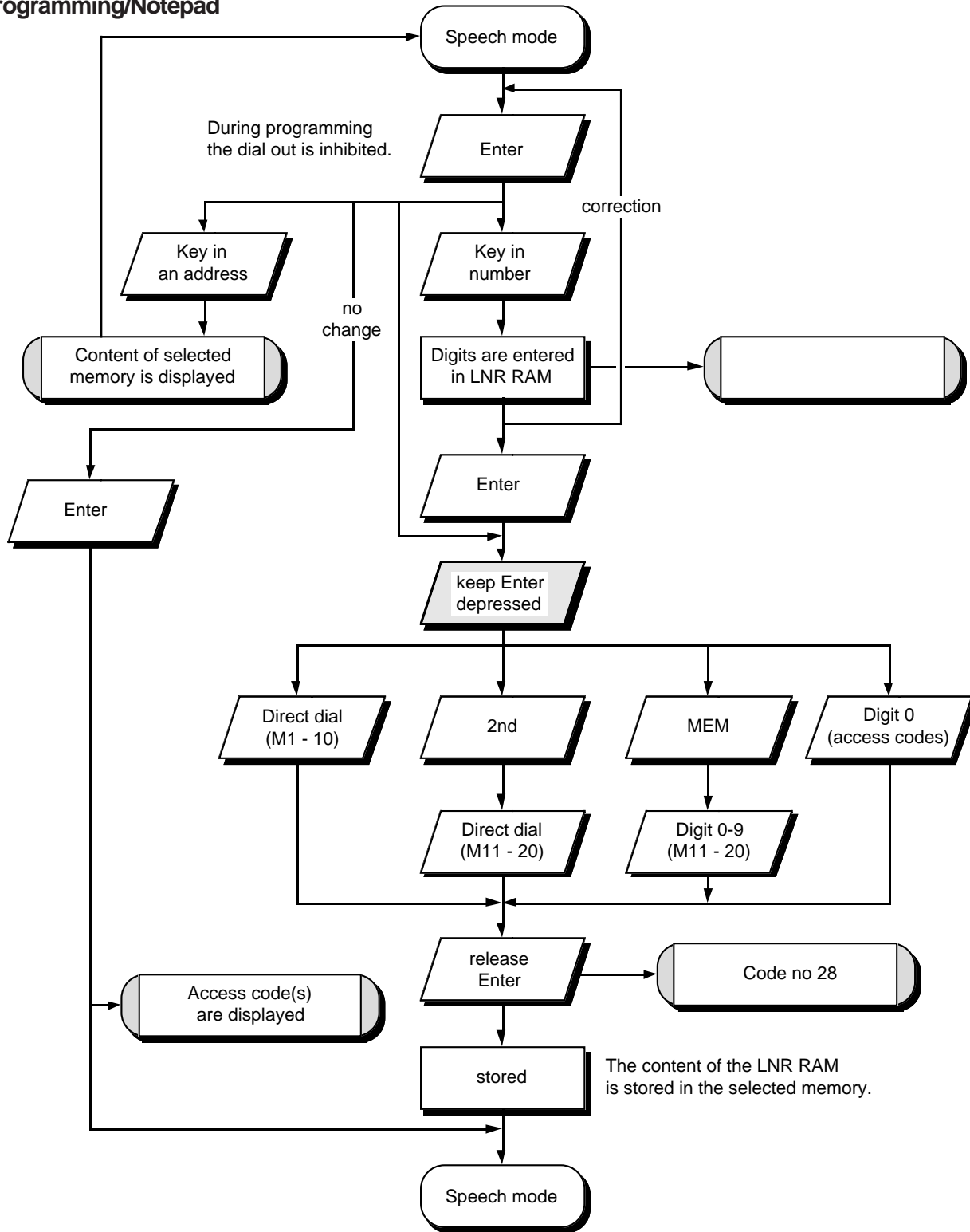

10 Direct dial keys, a **MEM** and a **2nd** key are available for addressing up to 20 numbers. Each number can contain up to 18 digits, including recall and pauses. Programming a new number will automatically clear the previous. **2nd, #** has to be pressed between the different access codes.

Direct Dial/Abbreviated Dial/Last Number Redial

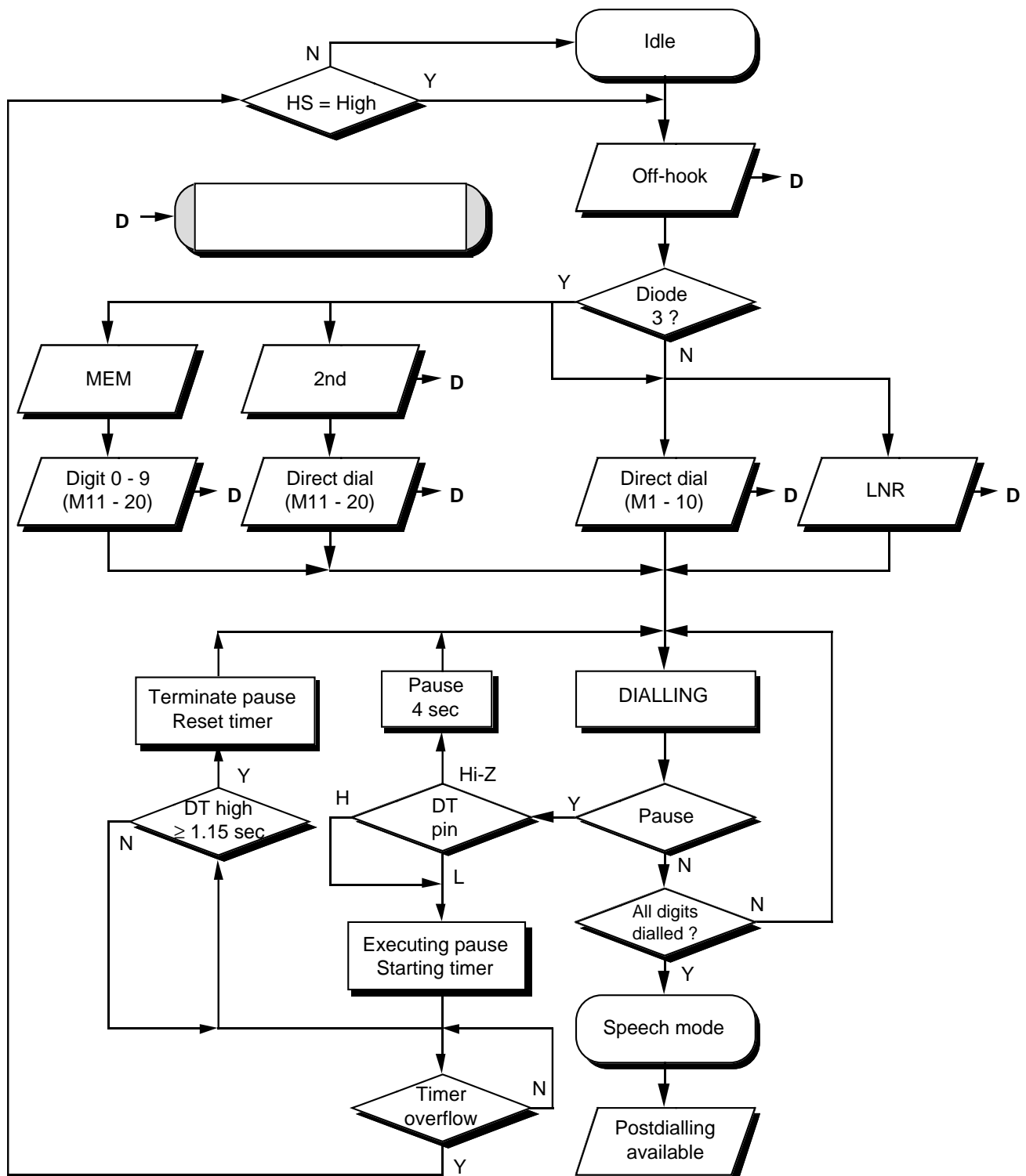

Automatic Call Progress (ACP)

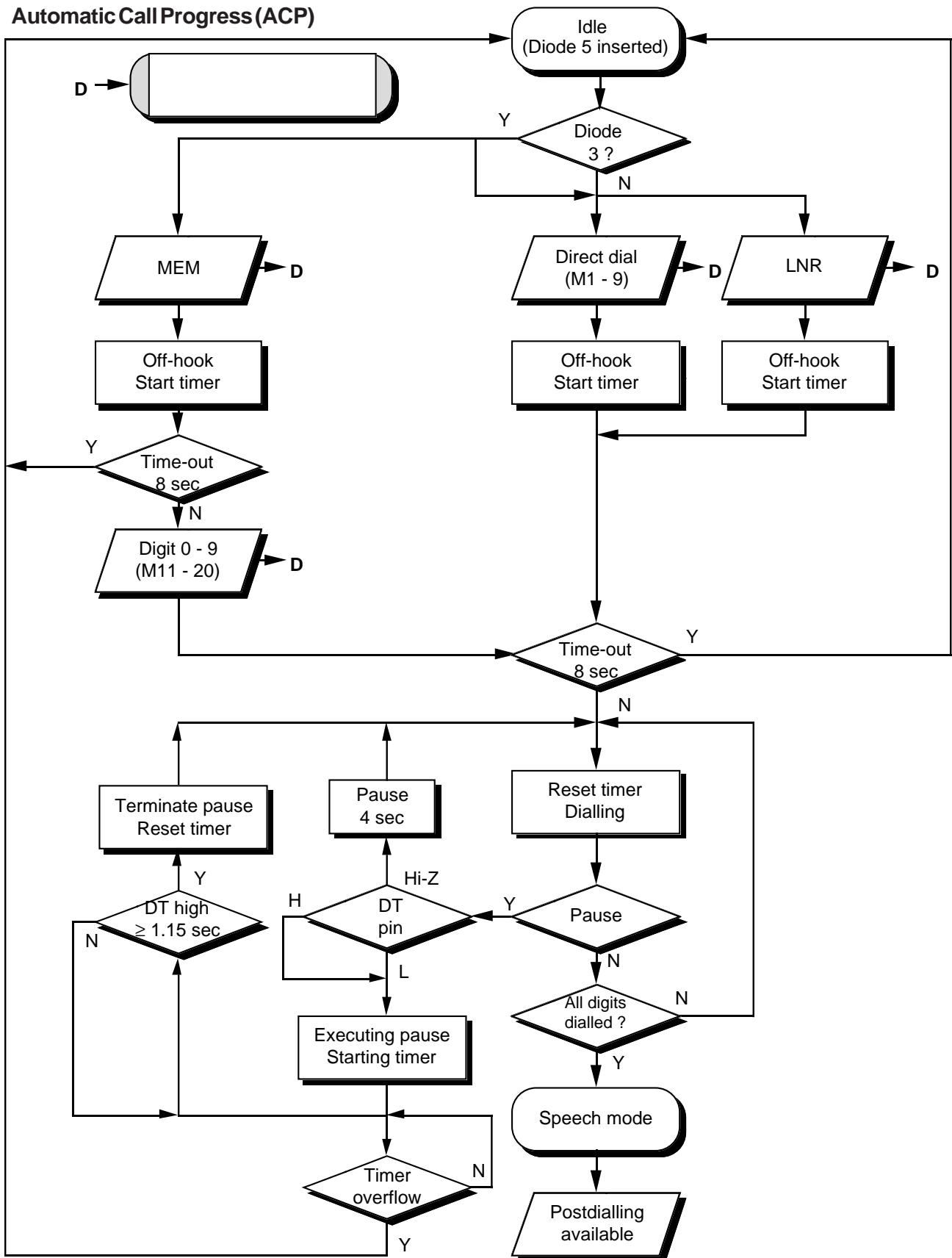

PrivacyMute

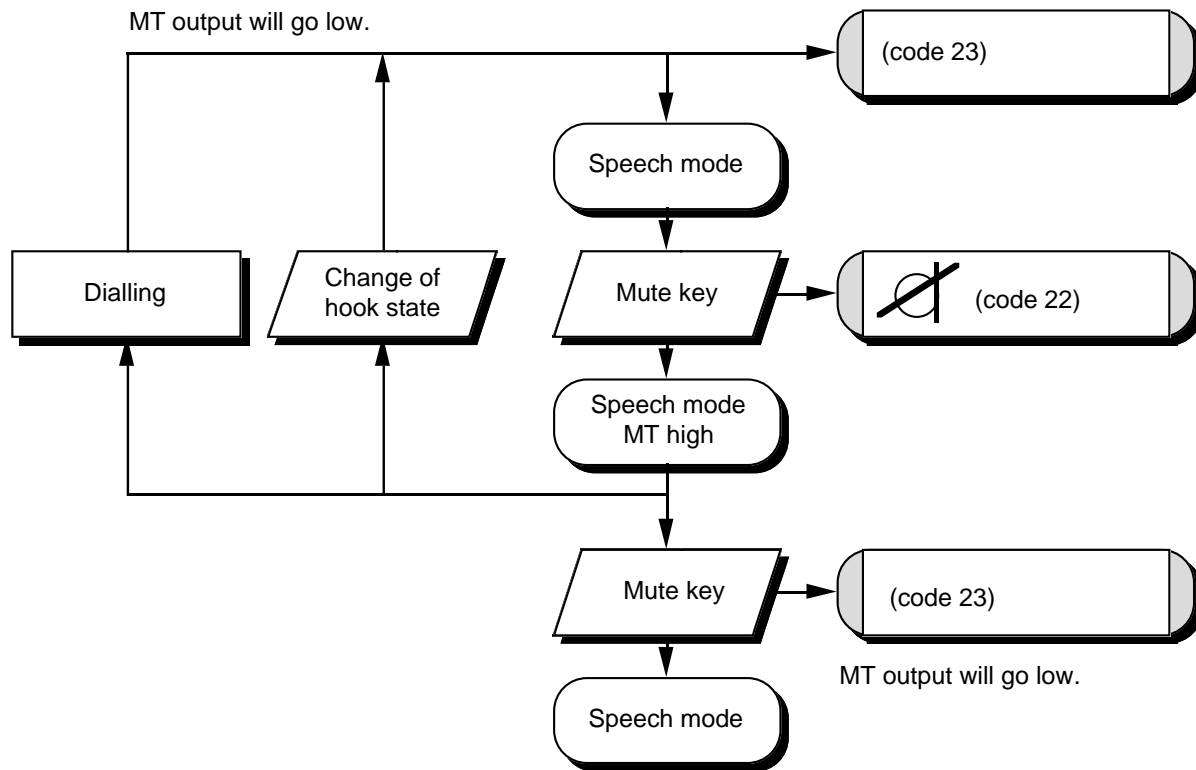

Temporary MF Select

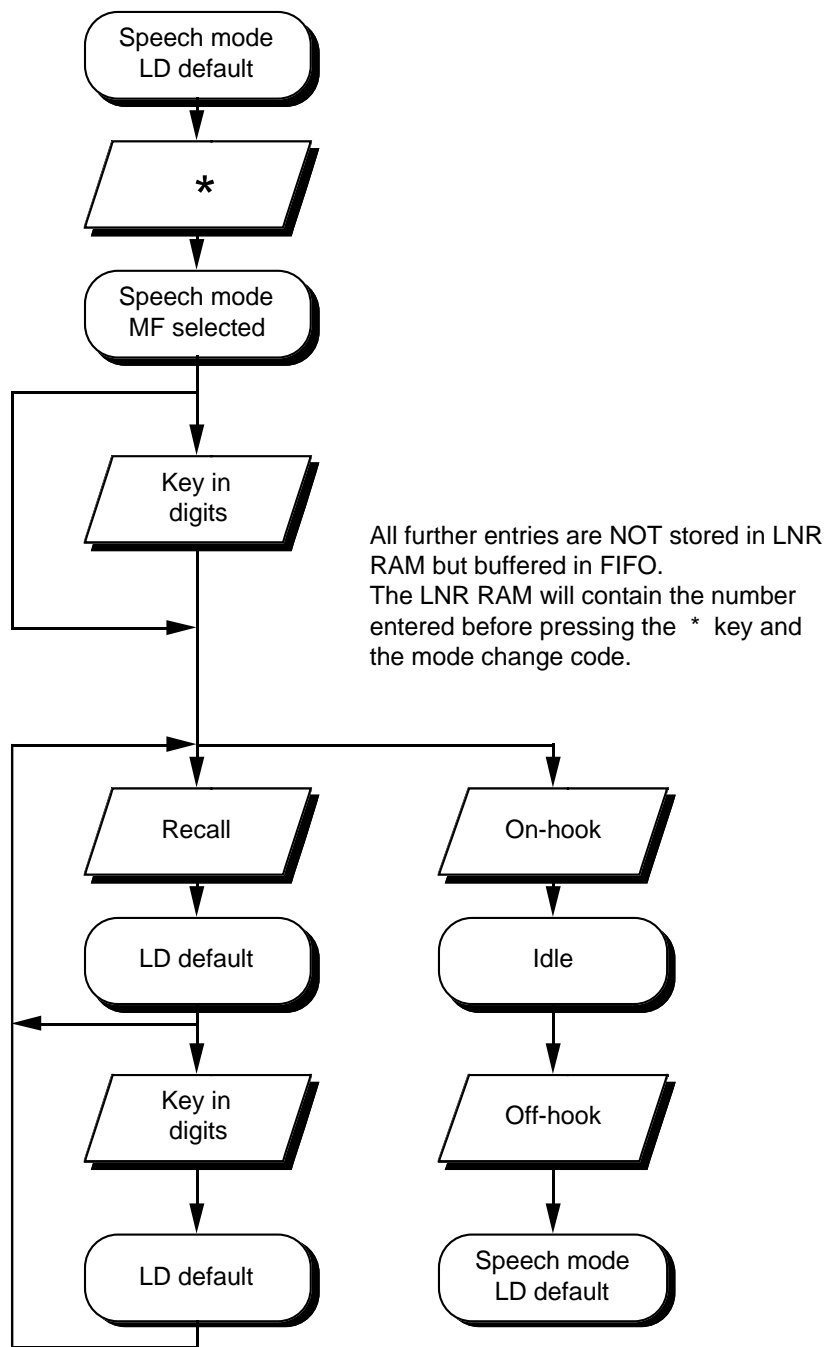

Setting Clock (in display driver)

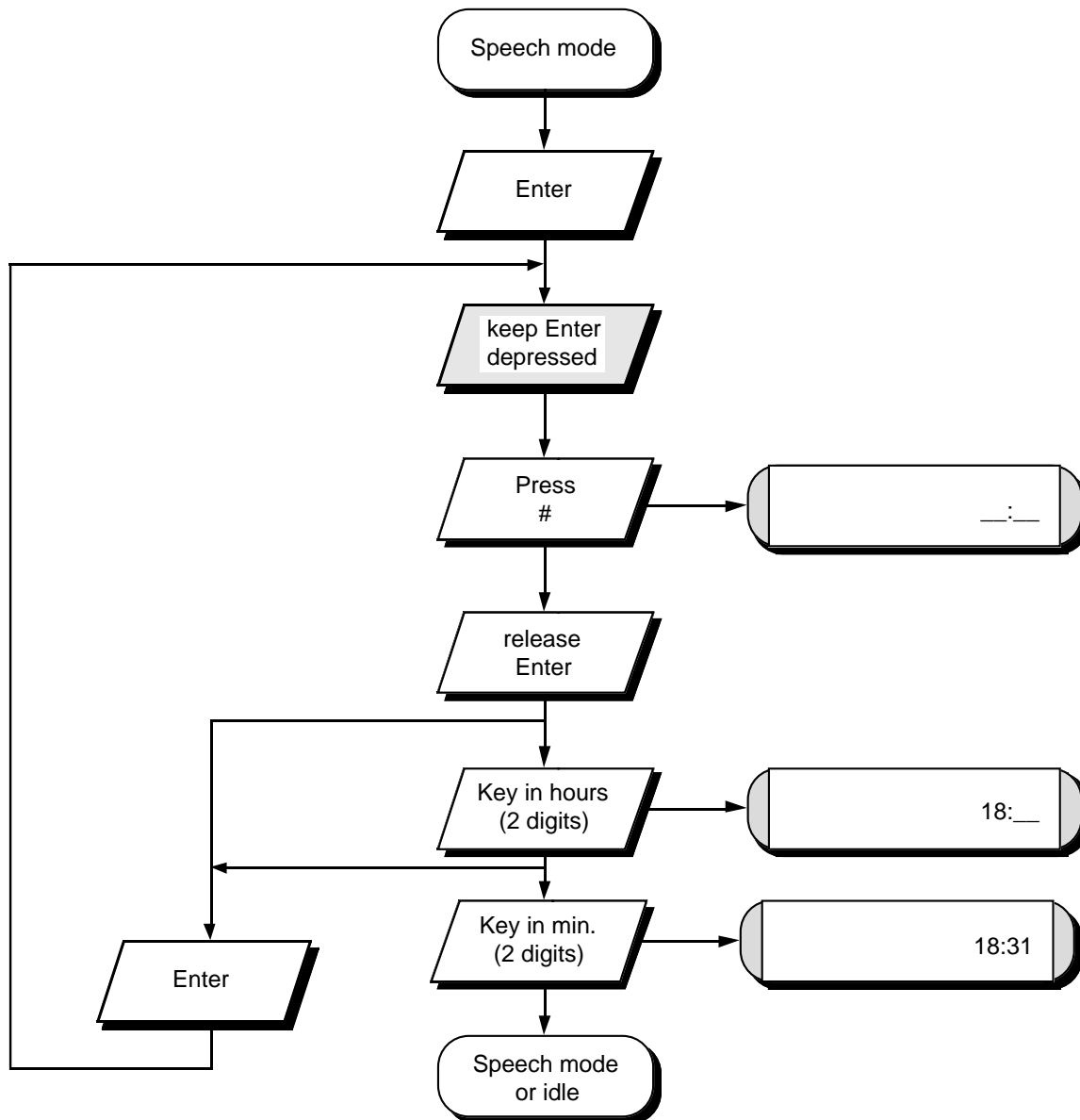

Hook States

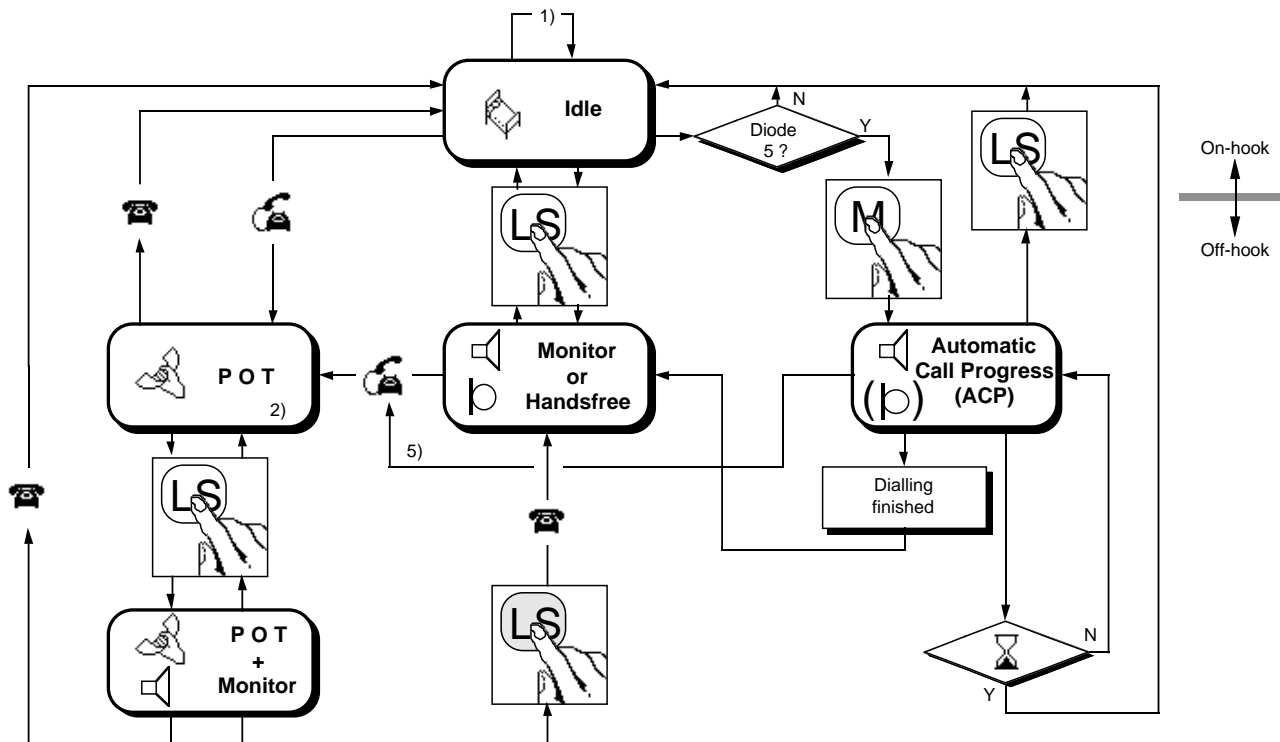

- 1) Pressing any invalid key doesn't have any effect in Idle state.
- 2) POT means Plain Ordinary Telephone.
- 3) Lift handset means HS going high.
- 4) Replace handset means HS going low.
- 5) Lifting the handset during ACP will change the hook state to POT, however, the dialling will continue unaffected.



Timing Diagrammes

The timing diagrammes do not show the correct scaling only the sequence.

P.O.T.

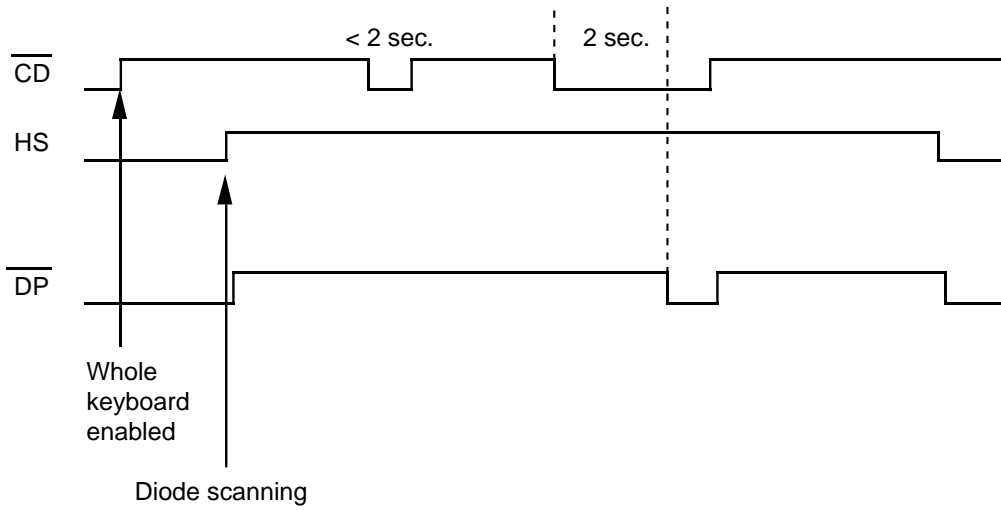

Monitor State

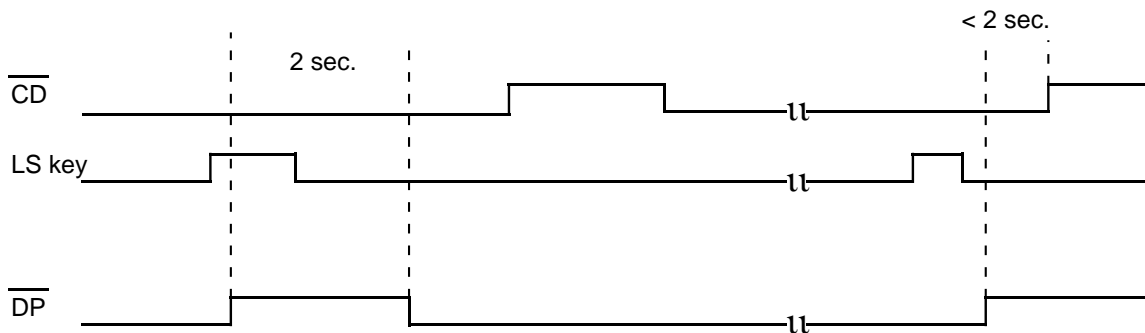
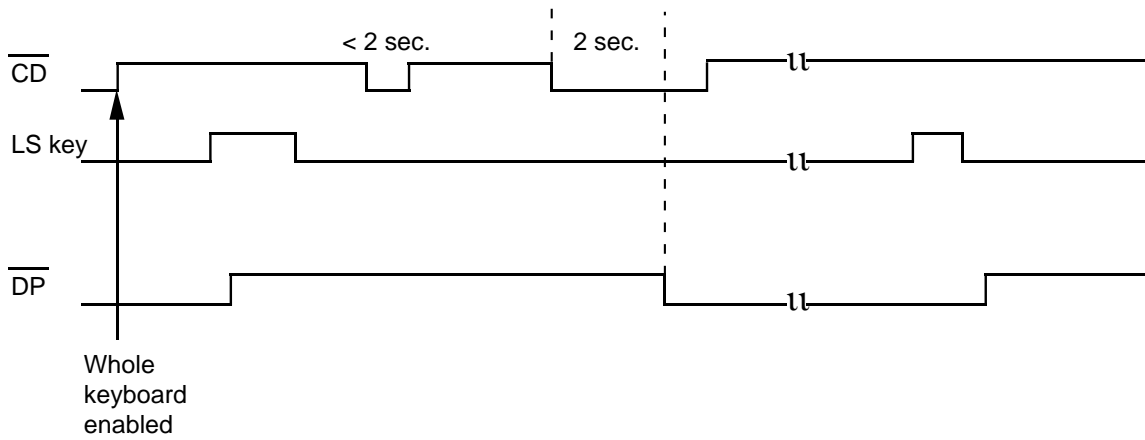

**LDDialling**

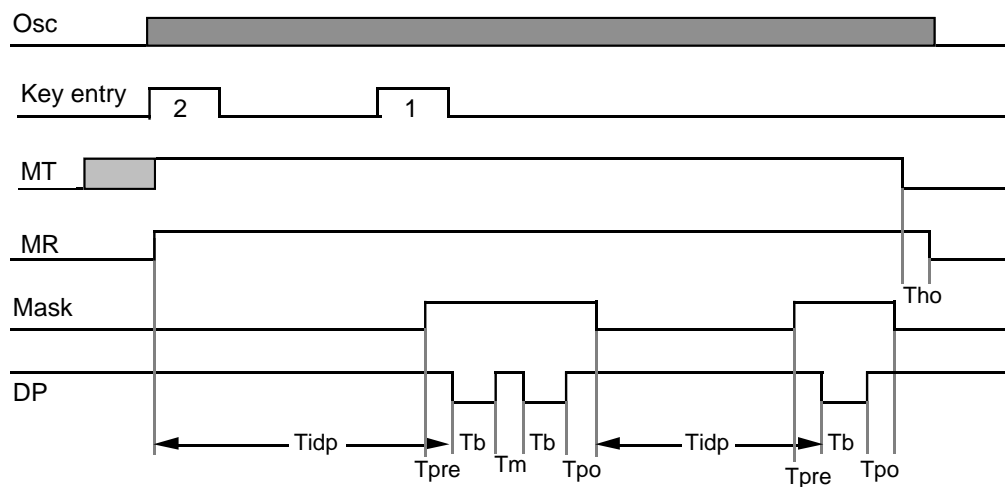

▒ = depending on **Mute** key  
(high when **Mute** key has been activated, otherwise low)

**MF Dialling**

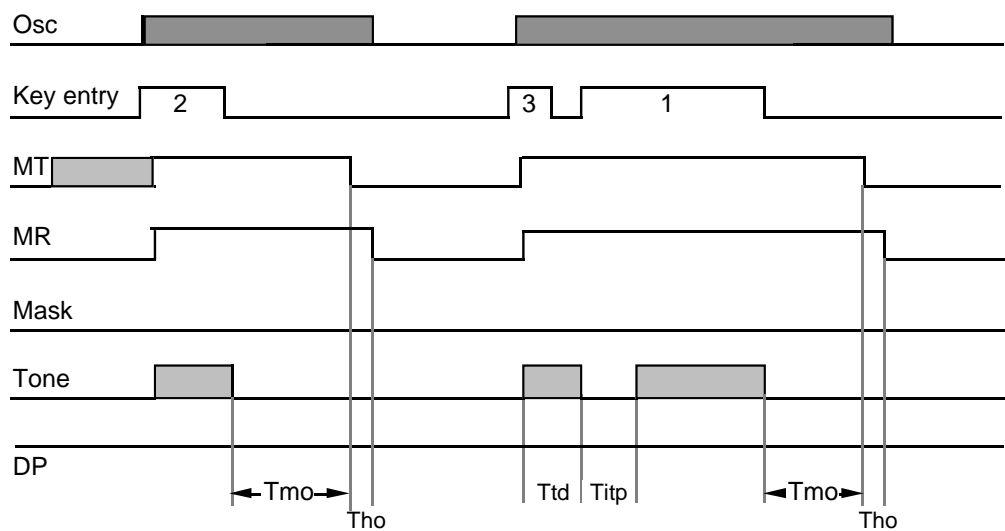

▒ = depending **Mute** key  
(high when **Mute** key has been activated, otherwise low)

Flash

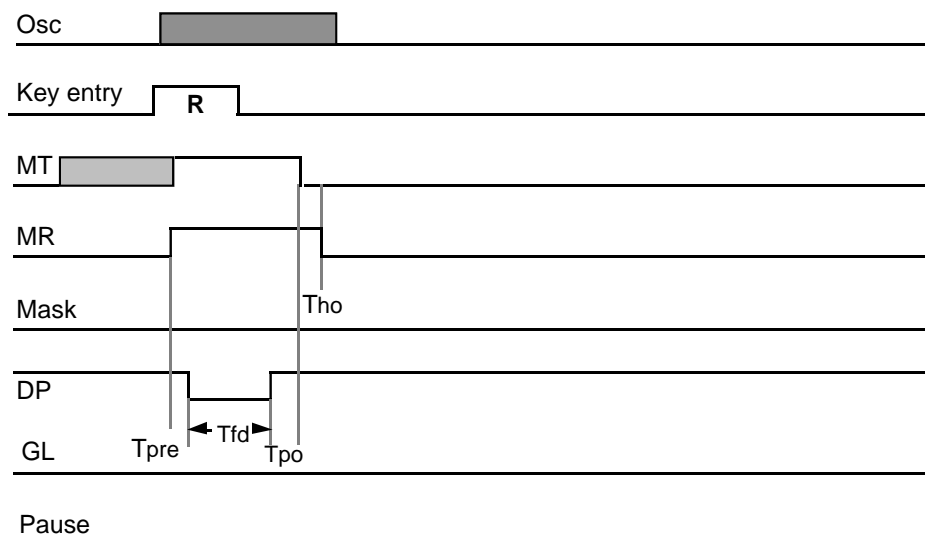

 = depending on **Mute** key  
(high when **Mute** key has been activated, otherwise low)

Ground Loop (GL)

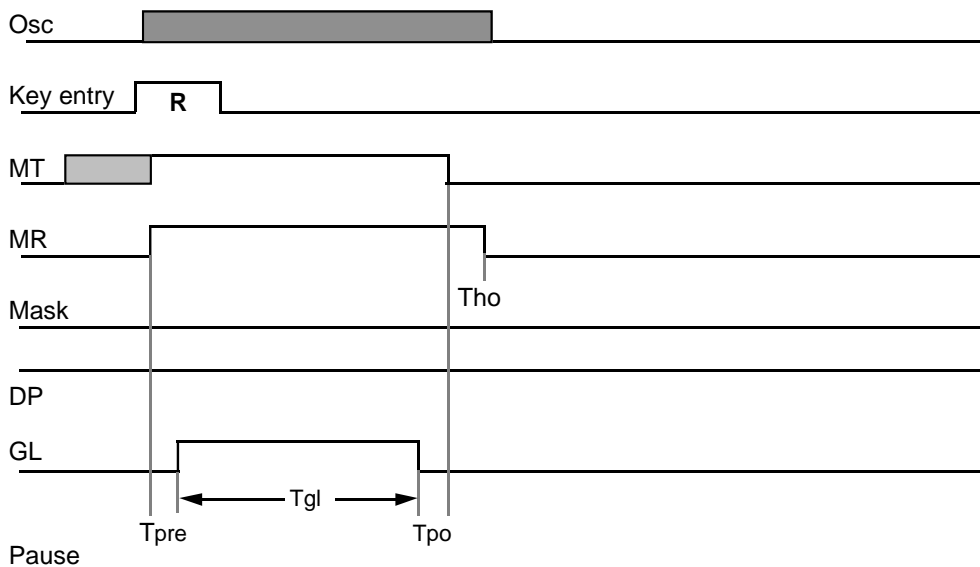

 = depending on **Mute** key  
(high when **Mute** key has been activated, otherwise low)

**Automatic Dialling LD** (content of LNR is GL, 2, 1 and GL is stored as access code)

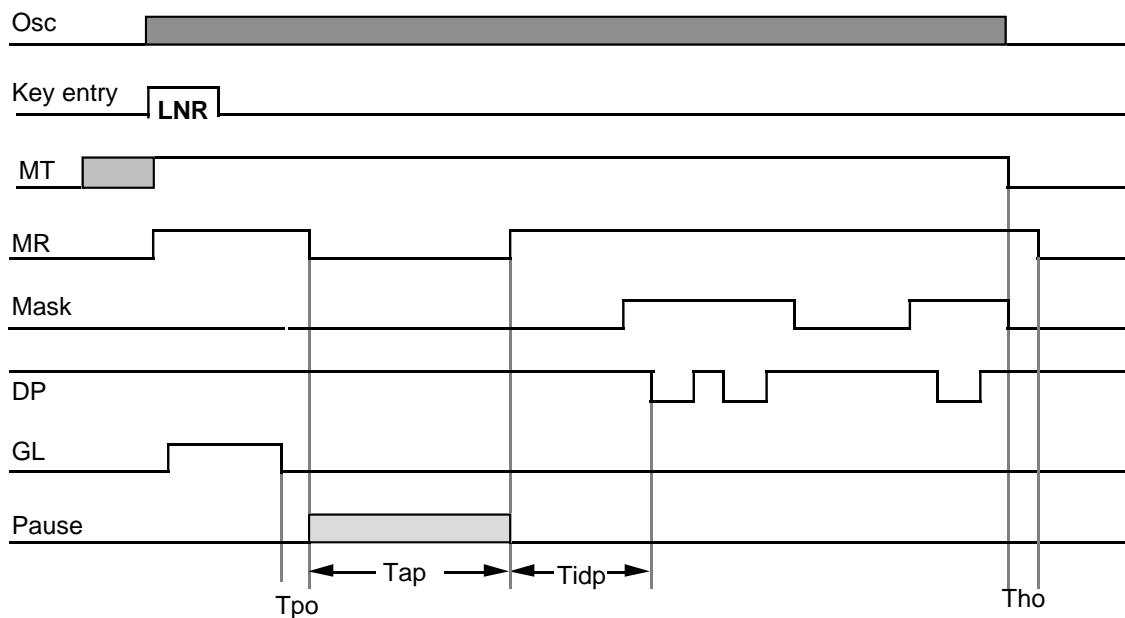

■ = depending on **Mute** key  
(high when **Mute** key has been activated, otherwise low)

**Automatic Dialling MF** (content of LNR is Flash, 1, 2, 3, and Flash is stored as access code)

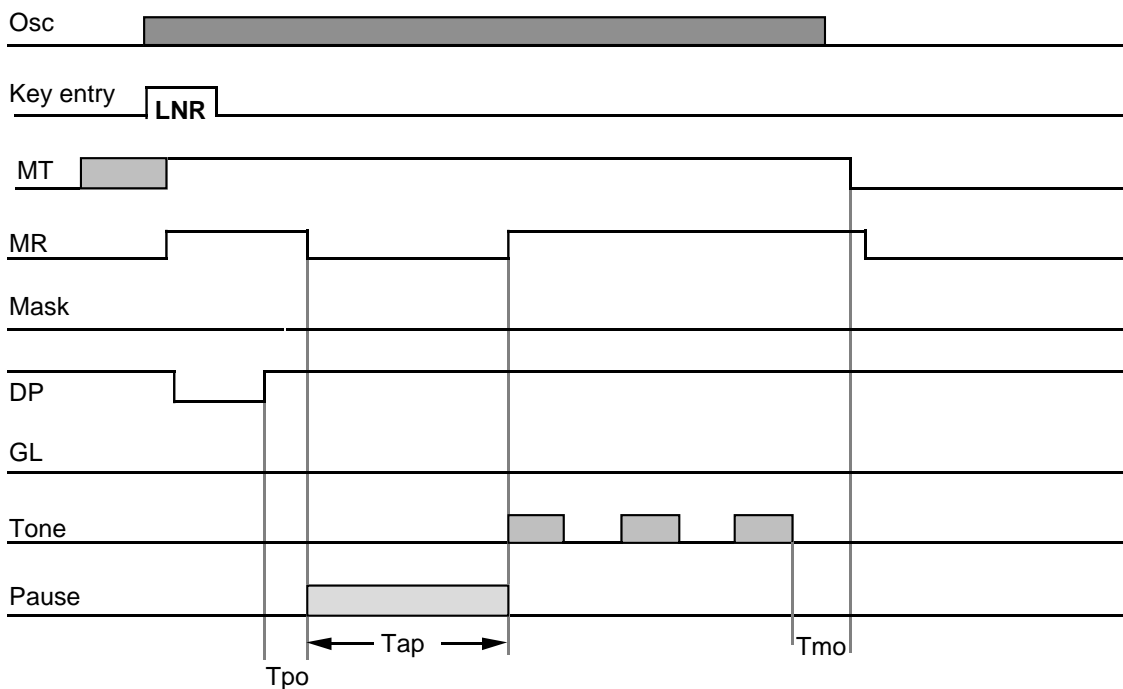

■ = depending on **Mute** key  
(high when **Mute** key has been activated, otherwise low)

## Electrical Data

## Absolute Maximum Ratings

Positive Supply Voltage .....	$-0.3V \leq V_{LS} \leq 7V$
Input Voltage .....	$-0.3V \leq V_{IN} \leq V_{DD} + 0.3V$
Input Current .....	$\pm 25 \text{ mA}$
Storage Temperature .....	$-65^{\circ}\text{C to } +125^{\circ}\text{C}$
Electrostatic Discharge (HBM) .....	$\pm 1000V$

## Recommended Operating Range

Parameter	Symbol	Min	Typ	Max	Unit	Condition
Operating Temperature	Top	- 25		70	°C	
Operating Voltage	$V_{DD}$	2.5	3.0	5.5	V	
Retention Voltage	$V_{DD}$	1.8		5.5	V	
Oscillator Frequency	Fosc		681		kHz	

## DC Characteristics

Default conditions: Recommended Operating Range;  $V_{DD} = 3.0V$ .

Parameter	Symbol	Min	Typ	Max	Unit	Condition
Supply Current	$I_{DD}$					Outputs unloaded
Operating except MF			200	250	$\mu\text{A}$	
Operating MF			0.75	1	mA	
Data Retention			1	2	$\mu\text{A}$	$V_{DD}=1.8V$ ; note1
			2	4	$\mu\text{A}$	Note 1
Input Voltage						
Low	$V_{il}$	$V_{SS}$		$0.3 \times V_{DD}$	V	
High	$V_{ih}$	$0.7 \times V_{DD}$		$V_{DD}$	V	
Input Current						
Low	$I_{il}$			1	$\mu\text{A}$	
High	$I_{ih}$			1	$\mu\text{A}$	
Output Current						
Sink	$I_{ol}$	1.5			mA	$V_{ol} = 0.4V$
Source	$I_{oh}$	1			mA	$V_{oh} = V_{DD} - 0.4V$
Pull-down Resistor						
HS Input	Rhs	1			M $\Omega$	
CD Input	Rcd	1			M $\Omega$	
Scanning Current DT						During Pause
Sink	$I_{sl}$	20		150	$\mu\text{A}$	
Source	$I_{sh}$	20		150	$\mu\text{A}$	

Note 1: Circuit in Idle state (HS = Low and no key activated).

## Signalling Characteristics

Defaults conditions: Recommended Operating Range

Parameter	Symbol	Min	Typ	Max	Unit	Condition
Clock Startup Time	Ts			5	ms	
Key Debounce Time	Td	14		18	ms	
HS Debounce Time	Ths	21		26	ms	
CD Reset Delay Time	Tr		2		sec	
DTMF						
Tone Level, High Group	Vol	-12.4	-10.9	-9.4	dBm	RL = 15 kΩ
Preemphasis		2	2.5	2.8	dBm	RL = 15 kΩ
Distortion				-26	dB	RL = 15 kΩ, note 3
Tone Duration	Ttd	80	82.3	85	ms	Note 1
Inter Tone Pause	Titp	80	82.3	85	ms	Note 1
Tone Rise/Fall Time	Ttr			5	ms	Note 2
LD						
Dial Rate			10		pps	± 5%
Make/Break Period	Tm/Tb		33/66		ms	± 5%
(diode option)			40/60		ms	± 5%
Inter Digit Pause	Tidp	753		785	ms	
Pre Digit Pause	Tpre	55		57	ms	
Post Digit Pause	Tpo	55		57	ms	
Flash						
Duration	Tfd	100	101.2	103	ms	No diode 2
		600		620	ms	With diode 2
Earth Recall						
Duration	Tg	500		510	ms	
Automatic Access Pause						
Short	Tap	4	4.1	4.2	sec	DT = Hi-Z
Long		7.9	8	8.1	sec	DT = Low
Termination		1.15	1.2	1.25	sec	DT = High
Mute Overhang	Tmo	182	200	223	ms	
MR/MT Hold Over	Tho	18		27	ms	
Tone Burst						
Frequency	Fb	700		800	Hz	
Output Level	Vtb	-13	-11	-9	dBm	
Tone Duration	Ttb	80		85	ms	
Inter Tone Pause (LS)	Titb1	7	8	9	sec	
Inter Tone Pause (Mute)	Titp2	1.8	2	2.2	sec	
Time-out	Tto	7.7	8	8.2	sec	

Note 1: The values are valid during automatic dialling and are minimum values during manual dialling, i.e. the tones will continue as long as the key is depressed.

Note 2: The rise time is the time from valid key detection (key has been debounced) till the tone amplitude has reached 90 % of its final value.

Note 3: Relative to high group.

Pin Configuration

28 Pin DIP

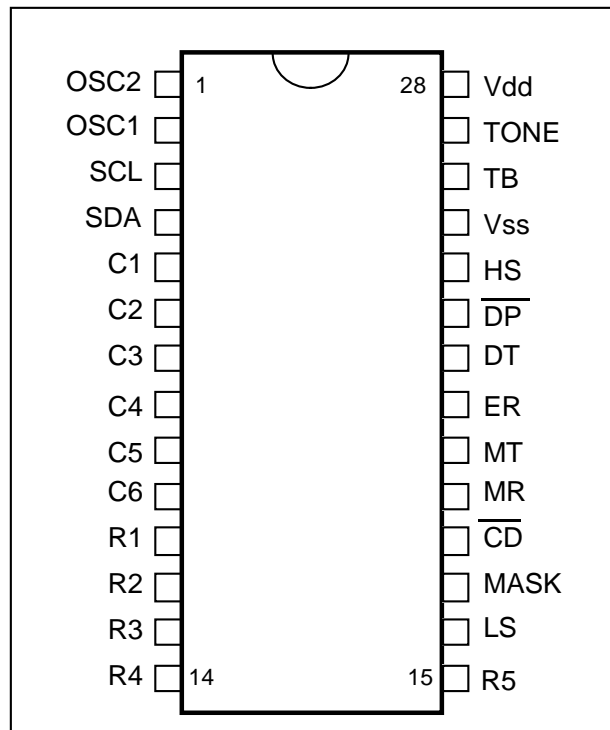

28 Pin SOIC

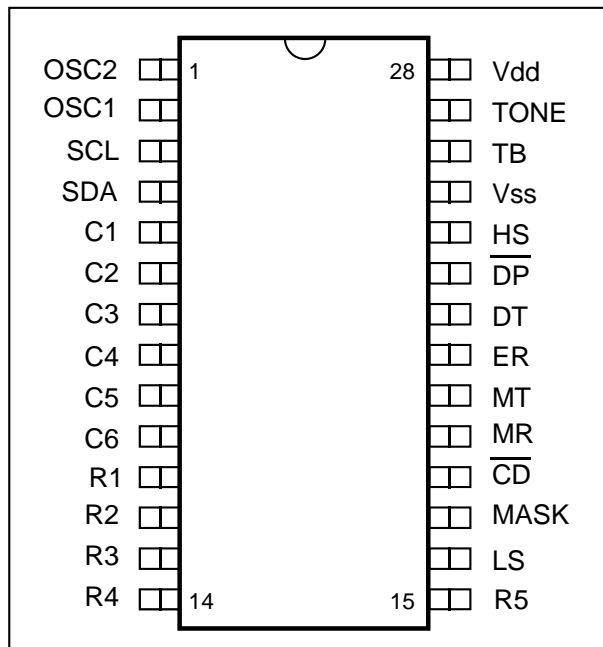

28 Pin PLCC

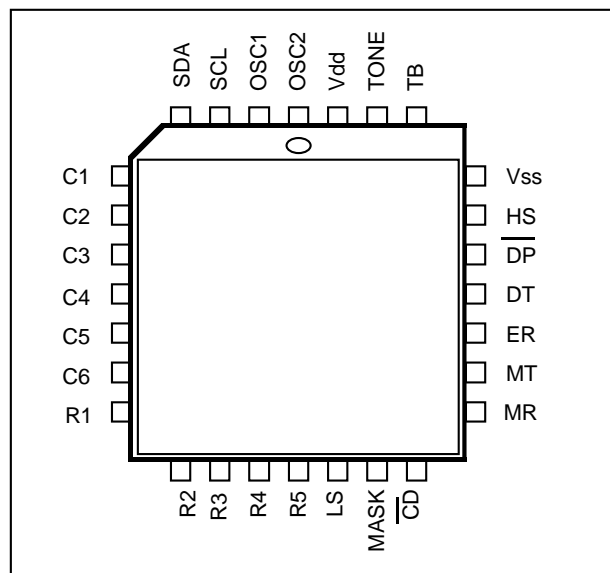

Ordering Information

**Part number**  
AS2574B P  
AS2574B N

**Package**  
28 pin DIL  
28 pin PLCC

Devices sold by Austria Mikro Systeme are covered by the warranty and patent indemnification provisions appearing in its Term of Sale. Austria Mikro Systeme makes no warranty, express, statutory, implied, or by description regarding the information set forth herein or regarding the freedom of the described devices from patent infringement. Austria Mikro Systeme reserves the right to change specifications and prices at any time and without notice. Therefore, prior to designing this product into a system, it is necessary to check with Austria Mikro Systeme for current information. This product is intended for use in normal commercial applications. Applications requiring extended temperature range, unusual environmental requirements, or high reliability applications, such as military, medical life-support or life-sustaining equipment are specifically *not* recommended without additional processing by Austria Mikro Systeme for each application.

Copyright © 1995, Austria Mikro Systeme International, Schloss Premstätten, 8141 Unterpremstätten, Austria. Trademarks Registered®. All rights reserved. The material herein may not be reproduced, adapted, merged, translated, stored, or used without the prior written consent of the copyright owner.