



## SINGLE/DUAL CMOS ANALOG RC TIMER

### GENERAL DESCRIPTION

The ALD7555/ALD7556 timers are high performance single/dual monolithic analog RC timing circuits. They offer significantly upgraded performance in speed, leakage currents, supply current, stability, temperature voltage stability, and discharge output drive when compared to SE555/NE555, ICL7555, TLC555, and ICM7555.

The ALD7555/ALD7556 offer the benefits of high input impedance, thereby allowing smaller timing capacitors and a longer timing cycle; high speed; low power dissipation for battery operated environment; reduced supply current spikes, allowing smaller and lower cost decoupling capacitors.

Each timer is capable of producing accurate time delays and oscillations in both monostable and astable operation, and operates in the one-shot (monostable) mode or 50% duty cycle free running oscillation mode with a single resistor R and one capacitor C. The inputs and outputs are fully compatible with CMOS, NMOS or TTL logic.

There are three matched internal resistors (approximately 200KΩ each) that set the threshold and trigger levels at two-thirds and one-third respectively of V+. These levels can be adjusted by using the control terminal. When the trigger input is below the trigger level, the output is in the high state and sourcing 2mA. When the threshold input is above the threshold level at the same time the trigger input is above the trigger level, the internal flip-flop is reset, the output goes to the low state and sinks up to 10mA. The reset input overrides all other inputs and when it is active (reset voltage less than 1V), the output is in the low state. The discharge output has been significantly enhanced to eliminate the need for a separate external driver.

### FEATURES

- Improved accuracy and temperature stability
- High speed operation -- 2.5MHz typical oscillation at 5V
- High Discharge Sinking Current of 80mA at 5V
- Guaranteed low operating supply voltage of 2V to 10V
- Functional equivalent to and same pin-out as NE555/NE556, SE555, TLC555, ICM7555/ICM7556
- Greatly expanded high and low frequency ranges
- High speed, low power, monolithic CMOS technology
- Low supply current, typically: 50µA for ALD7555, 100µA for ALD7556
- Extremely low trigger, threshold and reset currents 10pA typical
- Operates in both monostable and astable modes
- Fixed 50% duty cycle or adjustable duty cycle
- CMOS, NMOS and TTL compatible input/output
- Low supply current spikes
- Rail to rail output

### ORDERING INFORMATION ("L" suffix denotes lead-free (RoHS))

Operating Temperature Range *		
0°C to +70°C	0°C to +70°C	-55°C to +125°C
8-Pin Small Outline Package (SOIC) ALD7555SAL	8-Pin Plastic DIP Package ALD7555PAL	8-Pin CERDIP Package ALD7555DA
14-Pin Small Outline Package (SOIC) ALD7556SBL	14-Pin Plastic DIP Package ALD7556PBL	14-Pin CERDIP Package ALD7556DB

\* Contact factory for leaded (non-RoHS) or high temperature versions.

### BENEFITS

- Saves battery power
- Eliminates additional buffer
- Smaller, lower cost capacitor
- Extended range of time constants

### APPLICATIONS

- High speed one-shot (monostable)
- Precision sequential timing
- Long delay timer
- Pulse width and pulse position modulation
- Missing pulse detector
- Frequency divider
- Synchronized timer

### PIN CONFIGURATION

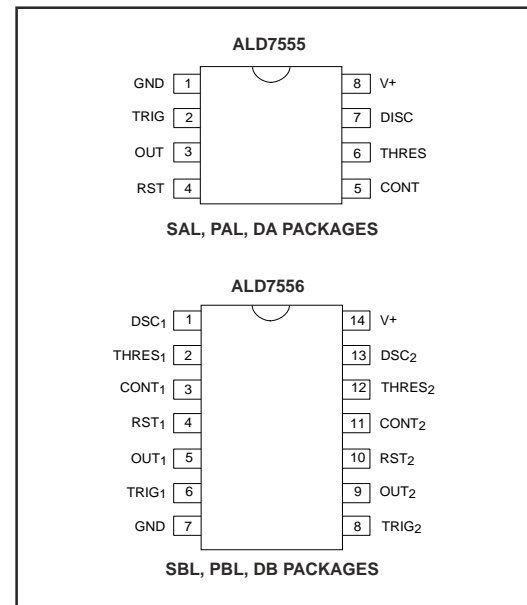

### BLOCK DIAGRAM (EACH TIMER)

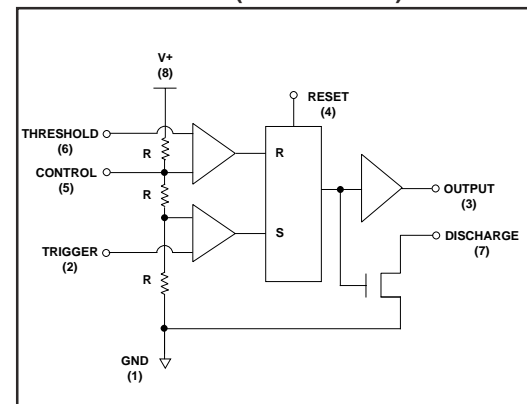

## ABSOLUTE MAXIMUM RATINGS

Supply voltage, V+ \_\_\_\_\_ 13.2V  
 Input voltage range \_\_\_\_\_ -0.3V to V+ +0.3V  
 Power dissipation \_\_\_\_\_ 600 mW  
 Operating temperature range SAL, SBL, PAL, PBL package \_\_\_\_\_ 0°C to + 70°C  
 DA, DB package \_\_\_\_\_ -55°C to +125°C  
 Storage temperature range \_\_\_\_\_ -65°C to +150°C  
 Lead temperature, 10 seconds \_\_\_\_\_ +260°C

## OPERATING ELECTRICAL CHARACTERISTICS

T<sub>A</sub> = 25°C V+ = +5V unless otherwise specified

Parameter	Symbol	Min	Typ	Max	Unit	Test Conditions
Supply Voltage	V+	2		10	V	
Supply Current ALD7555 Supply Current ALD7556	I <sub>S</sub> I <sub>S</sub>		50 100	90 180	μA μA	Outputs Unloaded
Timing error / Astable mode Initial Accuracy	t <sub>err</sub>		1.0	2.5	%	C = 0.1μF
Drift with Temperature <sup>1</sup> Drift with Supply Voltage <sup>1</sup>	Δt/ΔT Δt/ΔV+		10.0 0.2		ppm/°C %/V	R <sub>A</sub> = 1KΩ R <sub>B</sub> = 1KΩ
Threshold Voltage	V <sub>TH</sub>	3.233	3.333	3.433	V	
Trigger Voltage	V <sub>TRIG</sub>	1.567	1.667	1.767	V	
Trigger Current <sup>2</sup>	I <sub>TRIG</sub>		.01	0.4	nA	
Reset Voltage	V <sub>RST</sub>	0.4	0.7	1.0	V	
Reset Current <sup>2</sup>	I <sub>RST</sub>		.01	0.4	nA	
Threshold Current <sup>2</sup>	I <sub>TH</sub>		.01	0.4	nA	
Control Voltage Level	V <sub>CONT</sub>	3.200	3.333	3.467	V	
Output Voltage Drop (Low)	V <sub>OL</sub>		0.2	0.4	V	I <sub>SINK</sub> = 10mA
Output Voltage Drop (High)	V <sub>OH</sub>	4.2	4.6		V	I <sub>SOURCE</sub> = -2mA
Rise Time of Output <sup>1</sup>	t <sub>r</sub>		10	30	ns	R <sub>L</sub> = 10MΩ
Fall Time of Output <sup>1</sup>	t <sub>f</sub>		10	30	ns	C <sub>L</sub> = 10pF
Discharge Transistor Leakage Current	I <sub>DL</sub>		.01	10	nA	
Discharge Voltage Drop	V <sub>DISC</sub>		0.5 0.2	1.0 0.4	V V	I <sub>DISCHARGE</sub> = 80mA I <sub>DISCHARGE</sub> = 30mA
Maximum Frequency Astable Mode	f <sub>MAX</sub>	1.0	2.5		MHz	R <sub>A</sub> = 470Ω R <sub>B</sub> = 200Ω C <sub>T</sub> = 100pF
Minimum Trigger Pulse Width <sup>1</sup>	t <sub>TRIG</sub>		50	100	ns	

Notes: <sup>1</sup> Sample tested parameters.

<sup>2</sup> Consists of junction leakage currents with strong temperature dependence.

## APPLICATION NOTES

### GENERAL INFORMATION

The ALD7555 and the ALD7556 devices are analog timers that are, in most situations, direct replacements or direct same pin-out upgrades for the ICM7555, ICM7556, NE/SE555 and NE/SE556 devices. Significantly improved performances for the ALD7555 and the ALD7556 include precision in timing, reduced leakage currents at all the pin terminals, faster switching speeds, reduced switching current spikes, enhanced discharge output drive currents, better temperature stability, and better timing stability as a function of power supply.

These improvements not only improve on the timer function, but also improve on many of the thousands of circuits that depend on this timer architecture, such as modulation circuits, Schmitt triggers, astable circuits, and myriads of measurement and control circuits where the user may have reached performance limits with their ICM7555, ICM7556, NE/SE555 and NE/SE556 devices. For a given design, one or more specification of the timer device may become the circuit performance limiting factor. The ALD7555 and the ALD7556 devices are designed to address such limitations and in many cases offer a solution that is simpler and lower cost for a given design challenge than by other solutions by using other circuit means and techniques.

### ARCHITECTURE

The ALD7555 and the ALD7556 are analog timers that operate based on the RC timing principle, using an external timing resistor R and an external timing capacitor C. The C is charged by the R and then discharged via one of the two output pin connections provided by the ALD7555 and the ALD7556. The control of the two outputs are provided by one of the 4 input pins. The inputs are named THRESHOLD, CONTROL, RESET and TRIGGER. THRESHOLD and TRIGGER are connected to two separate voltage comparators with their respective comparator control levels set by an internal resistor string, consisting of three equal-valued and matched resistors. The output of the two comparators set an internal RS flip-flop circuit, which in turn controls an OUTPUT and a DISCHARGE output. See Block Diagram for a simplified equivalent circuit. The OUTPUT swings from rail to rail of the supply voltage, whereas the DISCHARGE only sinks current when it is active.

The ALD7555 and the ALD7556 operates by charging and discharging the RC timing between  $1/3$  and  $2/3$   $V_+$ , and by a feedback function provided by the user through the OUTPUT and/or DISCHARGE pins. This feedback is provided by the application circuit external connections, which determines the mode of the circuit operation. The architecture of this timer takes advantage of the fact that all charging and discharging of C are referenced by the reference resistor string that provide reference voltages proportional to supply voltage  $V_+$  ( $V_{dd}$ ). As the charging and the discharging of the capacitor C is also proportional to  $V_+$ , the frequency of oscillation is independent of  $V_+$  voltage levels.

The three most basic modes of these external connections are shown as Astable Mode (Free Running Mode), 50% Duty Cycle Mode, and the Monostable Mode. See Typical Applications. There are thousands of application circuits developed that allow the user to manipulate this feedback function, and which then produces many unique functions that is beyond a basic timer function. The application versatility of The ALD7555 and the ALD7556 is only limited by the imagination of the circuit designer.

### LOW POWER SUPPLY REQUIREMENTS

The CMOS process and the design of the ALD7555 and the ALD7556 devices utilize three well-matched on-chip high impedance resistors to build the internal reference resistor string to provide very low power supply operation. Another technique to achieve low power supply requirement is by using low power MOSFET circuits on-chip, and by allowing the user to use a combination of off-chip timing resistor and capacitor that would reduce their power consumption as well. Generally, this is accomplished by using higher values for R and lower values for C in a combination that would still provide the timing required. Furthermore, reduced on-chip leakage currents improve on not only timing precision, but also greatly increased ranges of usable R and C values to generate the same RC time constant.

### ENHANCED DISCHARGE OUTPUT DRIVE

The Discharge Output Drive Currents of the ALD7555 and the ALD7556 devices are increased significantly (80mA) when compared to other timers so that in many applications where the user may use this output as an output driver instead of having to add another output driver or buffer circuitry. For example, in many situations, the Discharge Output Drive Current is sufficient to drive a relay or a Power MOSFET directly.

### ASTABLE OPERATION

ALD7555 and the ALD7556 devices are designed to function as astable oscillators. These timers can be connected to self trigger and run as a free running multivibrator. In the free running oscillator mode, the external capacitor C is charged through  $R_a$  and  $R_b$ , and it is discharged through  $R_b$  only. By adjusting the values of  $R_a$  and  $R_b$  in combination with the value of C, both the frequency and the duty cycle of the oscillator pulse can be adjusted. In the 50% astable mode, the charging and the discharging of C are performed by the same R between the same voltage levels set by the reference resistor string, and therefore timer provide a true 50% duty cycle square wave that is symmetrical. (See typical applications)

## APPLICATION NOTES (cont'd)

### MONOSTABLE OPERATION

In this mode of operation the ALD7555 and the ALD7556 can be connected as a one-shot circuit which produces an output pulse with a user-adjustable pulse delay time. The pulse delay time is set by the external R and C values, which together produce a RC time constant that is proportional to the time delay. (See typical applications) The pulse is started with an external negative going Trigger pulse applied to TRIGGER pin. This negative going pulse sets an internal flip-flop so that the external R and C can start the RC timing while the OUTPUT pin is in the HIGH state. The external C is being charged by the external R. When the voltage between the R and C is charged past the internal threshold voltage at the THRESHOLD pin, which is set at 66.6% of  $V_{+}$ , the internal comparator of the ALD7555 and the ALD7556 resets the internal flip-flop. This then turns on the Discharge Driver at DISCHARGE pin, and discharges the timing capacitor C. The cycle is completed when the OUTPUT is driven to a low state and the ALD7555 and the ALD7556 are again waiting for the next negative going trigger pulse at TRIGGER pin.

### CONTROL Voltage and RESET pins

The CONTROL pin directly accesses one input to the upper comparator. As the input reference resistor string has on-chip high impedance resistors, an input voltage at the CONTROL input can easily change the voltage at the comparator input. This allows the user to change the oscillation frequency, or modulate the oscillation frequency of the analog timer, with a separate user provided frequency. The CONTROL pin also allows a user-provided inhibit signal to stop and start the timer's oscillation.

The RESET terminal directly resets the internal RS flip-flop circuit, which in turn controls the OUTPUT and DISCHARGE pins. This function is activated by a low voltage input of 0.7V of 100 ns minimum duration. By injecting a variety of input signals in a combination to the TRIGGER, THRESHOLD, CONTROL and RESET pins, many interesting modulation and demodulation signals can be manipulated and/or generated by the circuit designer.

## TYPICAL PERFORMANCE CHARACTERISTICS

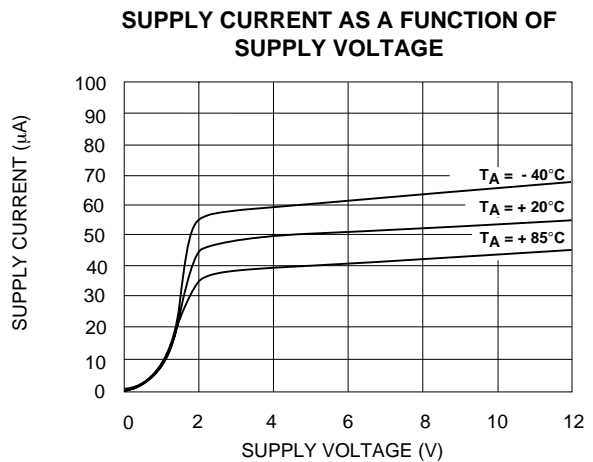
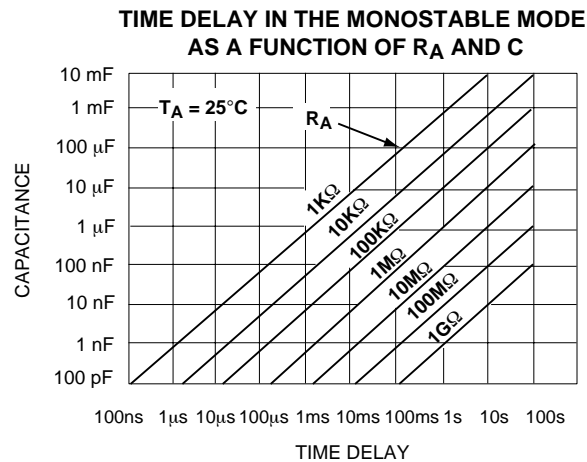
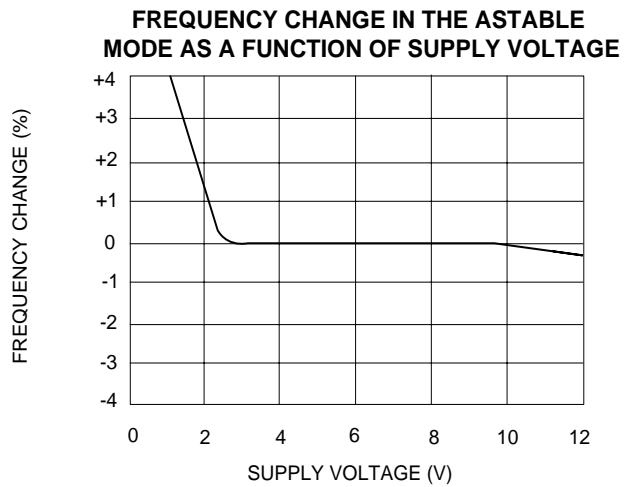
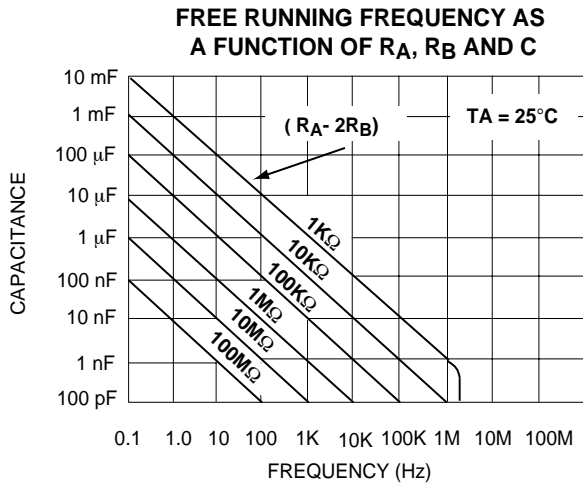
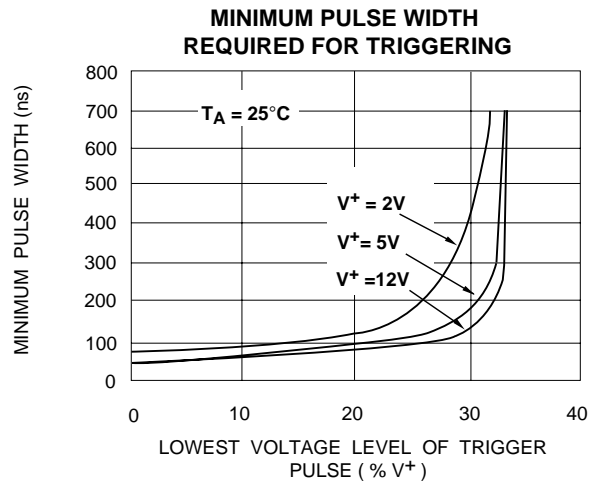
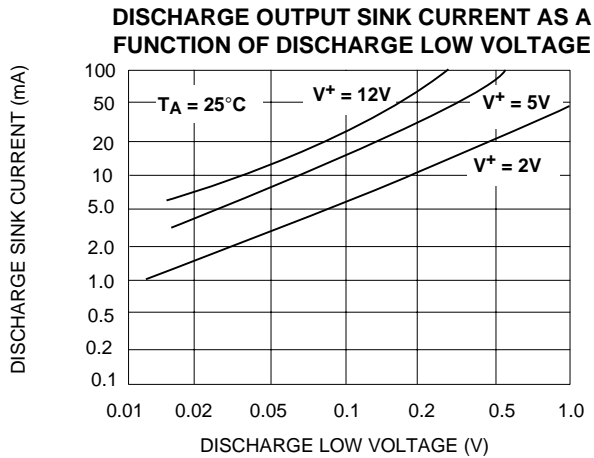

## TYPICAL PERFORMANCE CHARACTERISTICS (cont'd)

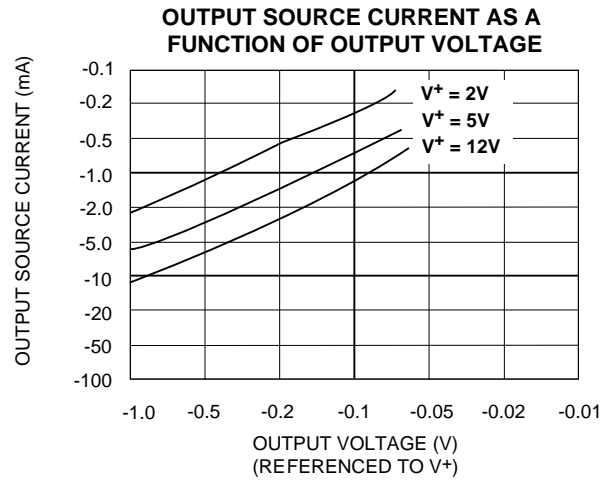
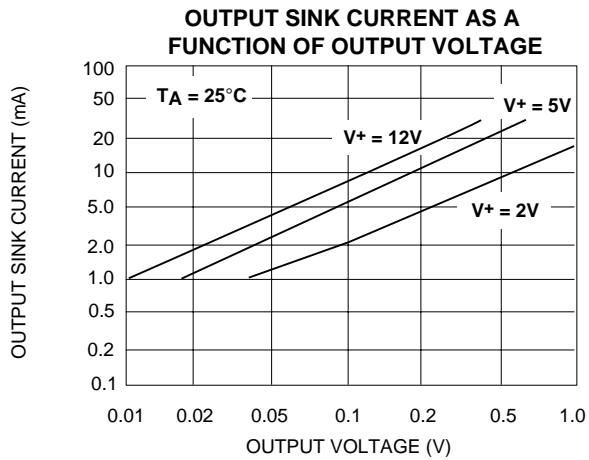

## TYPICAL APPLICATIONS (EACH TIMER)

### ASTABLE MODE OPERATION 50% DUTY CYCLE

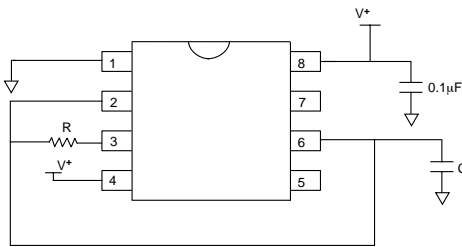

$$\text{Frequency } f = 1 / (1.4 R C)$$

### ASTABLE MODE OPERATION (FREE RUNNING OSCILLATOR)

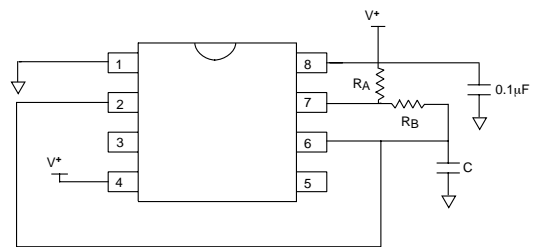

$$\text{Frequency } f = 1.46 / (R_A + 2R_B)C$$

$$\text{Duty Cycle DC} = R_B / (R_A + 2R_B)$$

### MONOSTABLE MODE OPERATION (ONE SHOT PULSE)

Pulse Delay  $t_d = 1.1 R C$

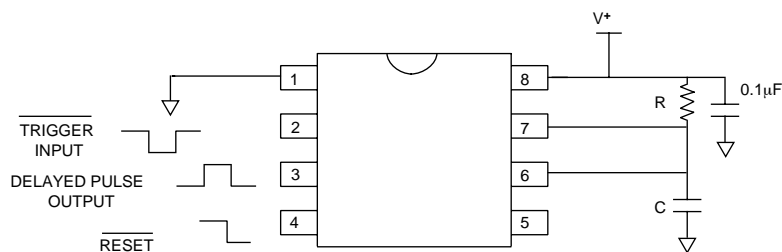

# SOIC-8 PACKAGE DRAWING

## 8 Pin Plastic SOIC Package



Dim	Millimeters		Inches	
	Min	Max	Min	Max
A	1.35	1.75	0.053	0.069
A <sub>1</sub>	0.10	0.25	0.004	0.010
b	0.35	0.45	0.014	0.018
C	0.18	0.25	0.007	0.010
D-8	4.69	5.00	0.185	0.196
E	3.50	4.05	0.140	0.160
e	1.27 BSC		0.050 BSC	
H	5.70	6.30	0.224	0.248
L	0.60	0.937	0.024	0.037
∅	0°	8°	0°	8°
S	0.25	0.50	0.010	0.020

# SOIC-14 PACKAGE DRAWING

## 14 Pin Plastic SOIC Package

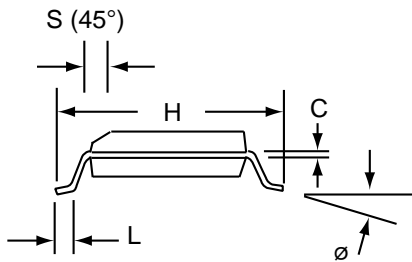
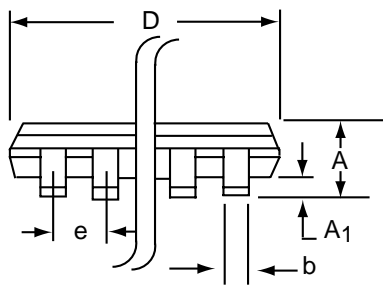
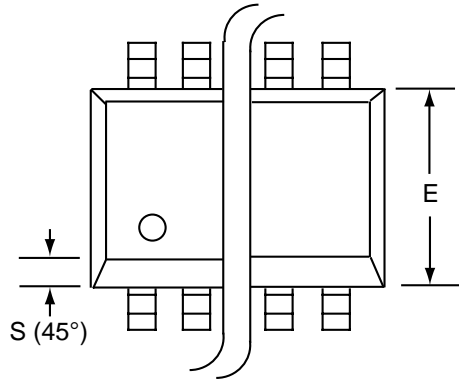

Dim	Millimeters		Inches	
	Min	Max	Min	Max
A	1.35	1.75	0.053	0.069
A <sub>1</sub>	0.10	0.25	0.004	0.010
b	0.35	0.45	0.014	0.018
C	0.18	0.25	0.007	0.010
D-14	8.55	8.75	0.336	0.345
E	3.50	4.05	0.140	0.160
e	1.27 BSC		0.050 BSC	
H	5.70	6.30	0.224	0.248
L	0.60	0.937	0.024	0.037
ø	0°	8°	0°	8°
S	0.25	0.50	0.010	0.020



# PDIP-8 PACKAGE DRAWING

## 8 Pin Plastic DIP Package

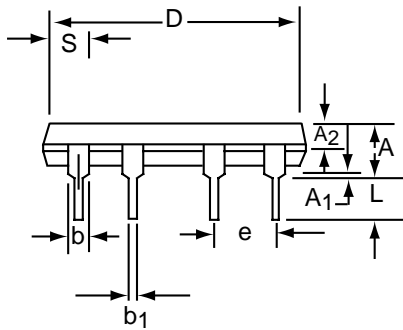
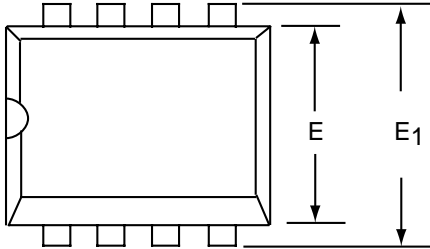

Dim	Millimeters		Inches	
	Min	Max	Min	Max
A	3.81	5.08	0.105	0.200
A <sub>1</sub>	0.38	1.27	0.015	0.050
A <sub>2</sub>	1.27	2.03	0.050	0.080
b	0.89	1.65	0.035	0.065
b <sub>1</sub>	0.38	0.51	0.015	0.020
c	0.20	0.30	0.008	0.012
D-8	9.40	11.68	0.370	0.460
E	5.59	7.11	0.220	0.280
E <sub>1</sub>	7.62	8.26	0.300	0.325
e	2.29	2.79	0.090	0.110
e <sub>1</sub>	7.37	7.87	0.290	0.310
L	2.79	3.81	0.110	0.150
S-8	1.02	2.03	0.040	0.080
∅	0°	15°	0°	15°

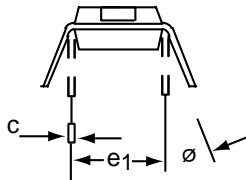

# PDIP-14 PACKAGE DRAWING

## 14 Pin Plastic DIP Package

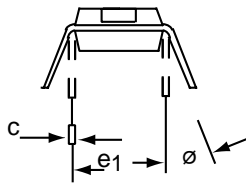
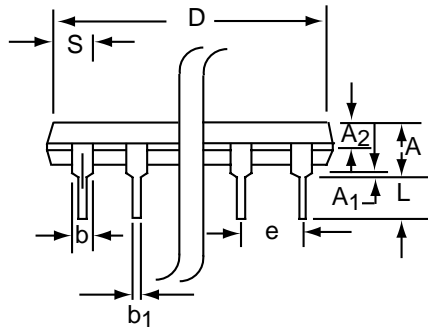
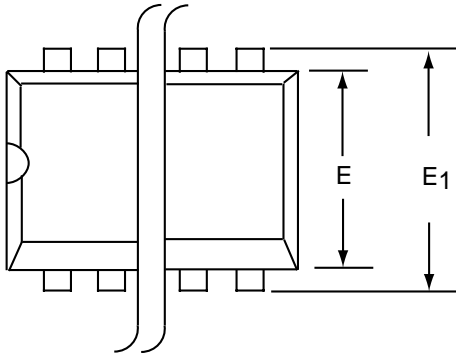

Dim	Millimeters		Inches	
	Min	Max	Min	Max
A	3.81	5.08	0.105	0.200
A1	0.38	1.27	0.015	0.050
A2	1.27	2.03	0.050	0.080
b	0.89	1.65	0.035	0.065
b1	0.38	0.51	0.015	0.020
c	0.20	0.30	0.008	0.012
D-14	17.27	19.30	0.680	0.760
E	5.59	7.11	0.220	0.280
E1	7.62	8.26	0.300	0.325
e	2.29	2.79	0.090	0.110
e1	7.37	7.87	0.290	0.310
L	2.79	3.81	0.110	0.150
S-14	1.02	2.03	0.040	0.080
φ	0°	15°	0°	15°

# CERDIP-8 PACKAGE DRAWING

## 8 Pin CERDIP Package

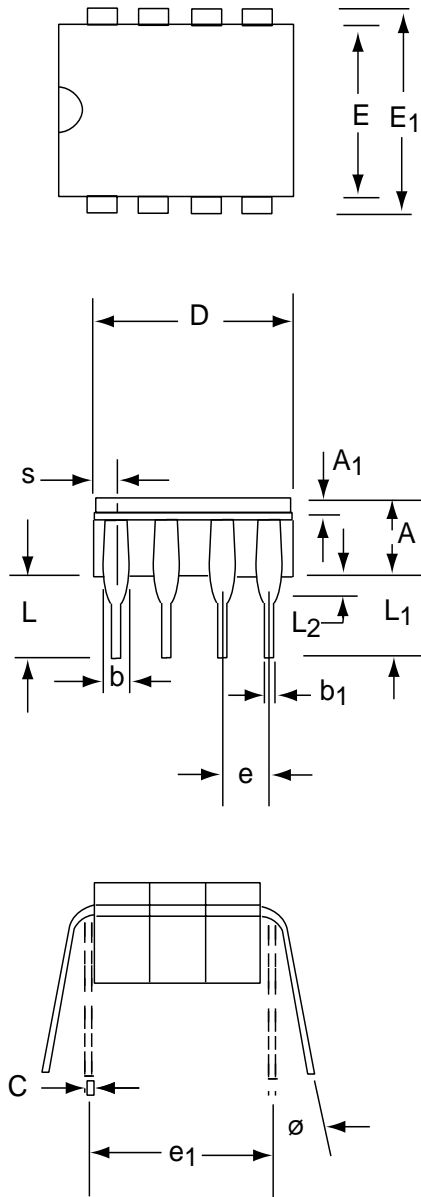

Dim	Millimeters		Inches	
	Min	Max	Min	Max
<b>A</b>	3.55	5.08	0.140	0.200
<b>A<sub>1</sub></b>	1.27	2.16	0.050	0.085
<b>b</b>	0.97	1.65	0.038	0.065
<b>b<sub>1</sub></b>	0.36	0.58	0.014	0.023
<b>C</b>	0.20	0.38	0.008	0.015
<b>D-8</b>	--	10.29	--	0.405
<b>E</b>	5.59	7.87	0.220	0.310
<b>E<sub>1</sub></b>	7.73	8.26	0.290	0.325
<b>e</b>	2.54 BSC		0.100 BSC	
<b>e<sub>1</sub></b>	7.62 BSC		0.300 BSC	
<b>L</b>	3.81	5.08	0.150	0.200
<b>L<sub>1</sub></b>	3.18	--	0.125	--
<b>L<sub>2</sub></b>	0.38	1.78	0.015	0.070
<b>S</b>	--	2.49	--	0.098
<b>∅</b>	0°	15°	0°	15°

# CERDIP-14 PACKAGE DRAWING

## 14 Pin CERDIP Package

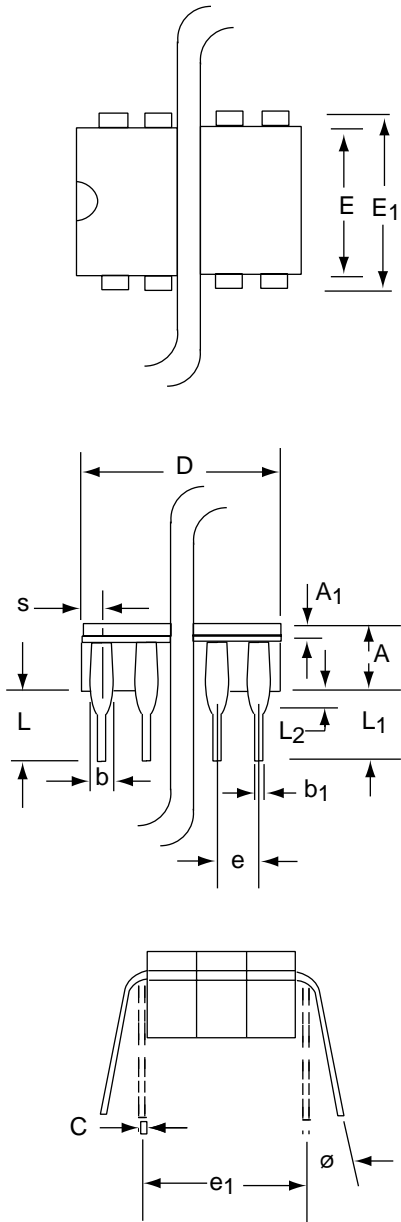

Dim	Millimeters		Inches	
	Min	Max	Min	Max
<b>A</b>	3.55	5.08	0.140	0.200
<b>A<sub>1</sub></b>	1.27	2.16	0.050	0.085
<b>b</b>	0.97	1.65	0.038	0.065
<b>b<sub>1</sub></b>	0.36	0.58	0.014	0.023
<b>C</b>	0.20	0.38	0.008	0.015
<b>D-14</b>	--	19.94	--	0.785
<b>E</b>	5.59	7.87	0.220	0.310
<b>E<sub>1</sub></b>	7.73	8.26	0.290	0.325
<b>e</b>	2.54 BSC		0.100 BSC	
<b>e<sub>1</sub></b>	7.62 BSC		0.300 BSC	
<b>L</b>	3.81	5.08	0.150	0.200
<b>L<sub>1</sub></b>	3.18	--	0.125	--
<b>L<sub>2</sub></b>	0.38	1.78	0.015	0.070
<b>S</b>	--	2.49	--	0.098
<b>∅</b>	0°	15°	0°	15°