

DATA SHEET

NEC

GaAs INTEGRATED CIRCUIT μ PG2409TB

HIGH POWER SPDT SWITCH FOR WiMAX™

DESCRIPTION

The μ PG2409TB is a GaAs MMIC high power SPDT (Single Pole Double Throw) switch which were designed for WiMAX.

This device can operate frequency from 0.5 to 3.8 GHz, having the low insertion loss and high isolation.

This device is housed in a 6-pin super minimold package (SC-88/SOT-363 type). And this package is suitable for high-density surface mounting.

FEATURES

- Switch control voltage : $V_{\text{cont (H)}} = 3.0 \text{ V TYP.}$
: $V_{\text{cont (L)}} = 0 \text{ V TYP.}$
- Low insertion loss : $L_{\text{ins}} = 0.35 \text{ dB TYP. @ } f = 1.0 \text{ GHz}$
: $L_{\text{ins}} = 0.45 \text{ dB TYP. @ } f = 2.5 \text{ GHz}$
: $L_{\text{ins}} = 0.50 \text{ dB TYP. @ } f = 3.0 \text{ GHz}$
- High isolation : $ISL = 32 \text{ dB TYP. @ } f = 1.0 \text{ GHz}$
: $ISL = 26 \text{ dB TYP. @ } f = 2.5 \text{ GHz}$
: $ISL = 23 \text{ dB TYP. @ } f = 3.0 \text{ GHz}$
- Handling power : $P_{\text{in (1 dB)}} = +35.0 \text{ dBm TYP. @ } f = 0.5 \text{ to } 3.8 \text{ GHz}$
- High-density surface mounting : 6-pin super minimold package (SC-88/SOT-363 type) (2.0 × 1.25 × 0.9 mm)

APPLICATIONS

- WiMAX and wireless LAN (IEEE802.11b/g/n)

ORDERING INFORMATION

| Part Number | Order Number | Package | Marking | Supplying Form |
|-------------------|---------------------|-----------------------------------------------------------|---------|-----------------------------------------------------------------------------------------------------------------------------------------------------------------|
| μ PG2409TB-E4 | μ PG2409TB-E4-A | 6-pin super minimold (SC-88/SOT-363 type) (Pb-Free) | G5T | <ul style="list-style-type: none">• Embossed tape 8 mm wide• Pin 4, 5, 6 face the perforation side of the tape• Qty 3 kpcs/reel |

Remark To order evaluation samples, please contact your nearby sales office.

Part number for sample order: μ PG2409TB

Caution Although this device is designed to be as robust as possible, ESD (Electrostatic Discharge) can damage this device. This device must be protected at all times from ESD. Static charges may easily produce potentials of several kilovolts on the human body or equipment, which can discharge without detection. Industry-standard ESD precautions must be employed at all times.

The information in this document is subject to change without notice. Before using this document, please confirm that this is the latest version.
Not all products and/or types are available in every country. Please check with an NEC Electronics sales representative for availability and additional information.

PIN CONNECTIONS AND INTERNAL BLOCK DIAGRAM

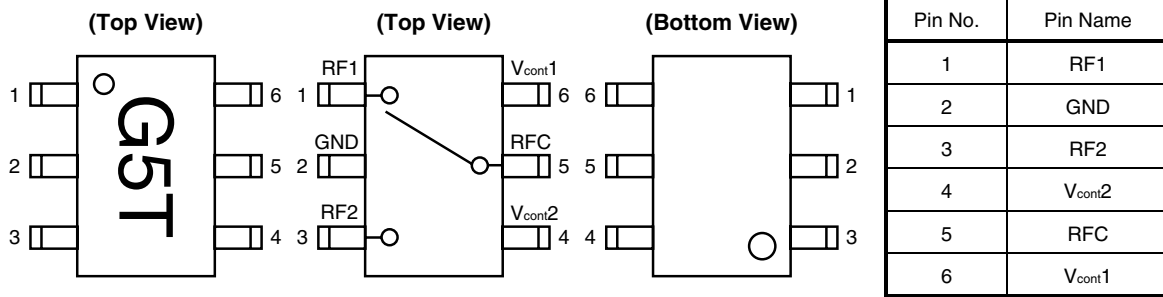

SW TRUTH TABLE

| On Path | V _{cont1} | V _{cont2} |
|---------|--------------------|--------------------|
| RFC-RF1 | High | Low |
| RFC-RF2 | Low | High |

ABSOLUTE MAXIMUM RATINGS (T_A = +25°C, unless otherwise specified)

| Parameter | Symbol | Ratings | Unit | |
|-------------------------------|-------------------------|----------------------|------|-----|
| Switch Control Voltage | V _{cont} | +6.0 ^{Note} | V | |
| Input Power | V _{cont} = 3 V | P _{in} | +35 | dBm |
| | V _{cont} = 5 V | P _{in} | +37 | |
| Power Dissipation (average) | P _D | 150 | mW | |
| Operating Ambient Temperature | T _A | -45 to +85 | °C | |
| Storage Temperature | T _{stg} | -55 to +150 | °C | |

Note |V_{cont1} - V_{cont2}| ≤ 6.0 V

RECOMMENDED OPERATING RANGE (T_A = +25°C, unless otherwise specified)

| Parameter | Symbol | MIN. | TYP. | MAX. | Unit |
|----------------------------|--------------------------------------------------------------------|------|------|------|------|
| Operating Frequency | f | 0.5 | - | 3.8 | GHz |
| Switch Control Voltage (H) | V _{cont (H)} | 2.7 | 3.0 | 5.3 | V |
| Switch Control Voltage (L) | V _{cont (L)} | -0.2 | 0 | 0.2 | V |
| Control Voltage Difference | ΔV _{cont (H)} , ΔV _{cont (L)} ^{Note} | -0.1 | 0 | 0.1 | V |

Note ΔV_{cont (H)} = V_{cont1 (H)} - V_{cont2 (H)}

ΔV_{cont (L)} = V_{cont1 (L)} - V_{cont2 (L)}

ELECTRICAL CHARACTERISTICS

(T_A = +25°C, V_{cont} (H) = 3.0 V, V_{cont} (L) = 0 V, Z₀ = 50 Ω, DC blocking capacitors = 8 pF, unless otherwise specified)

| Parameter | Symbol | Test Conditions | MIN. | TYP. | MAX. | Unit |
|----------------------------------------------------------|--------------------------|-----------------------------------------------------------------|------|-------|------|------|
| Insertion Loss 1 | L _{ins1} | f = 0.5 to 1.0 GHz ^{Note 1} | - | 0.35 | 0.60 | dB |
| Insertion Loss 2 | L _{ins2} | f = 1.0 to 2.0 GHz ^{Note 1} | - | 0.40 | 0.65 | dB |
| Insertion Loss 3 | L _{ins3} | f = 2.0 to 2.5 GHz | - | 0.45 | 0.70 | dB |
| Insertion Loss 4 | L _{ins4} | f = 2.5 to 3.0 GHz | - | 0.50 | 0.75 | dB |
| Insertion Loss 5 | L _{ins5} | f = 3.0 to 3.8 GHz | - | 0.60 | 0.85 | dB |
| Isolation 1 | ISL1 | f = 0.5 to 1.0 GHz ^{Note 1} | 29 | 32 | - | dB |
| Isolation 2 | ISL2 | f = 1.0 to 2.0 GHz ^{Note 1} | 25 | 28 | - | dB |
| Isolation 3 | ISL3 | f = 2.0 to 2.5 GHz | 23 | 26 | - | dB |
| Isolation 4 | ISL4 | f = 2.5 to 3.0 GHz | 20 | 23 | - | dB |
| Isolation 5 | ISL5 | f = 3.0 to 3.8 GHz | 16 | 19 | - | dB |
| Return Loss | RL | f = 0.5 to 3.8 GHz ^{Note 1} | 15 | 20 | - | dB |
| 0.1 dB Loss Compression Input Power ^{Note 2} | P _{in (0.1 dB)} | f = 2.5 GHz | - | +33.5 | - | dBm |
| 1 dB Loss Compression Input Power 1 ^{Note 3} | P _{in (1 dB) 1} | f = 0.5 to 3.8 GHz ^{Note 1} V _{cont} = 3 V | - | +35 | - | dBm |
| 1 dB Loss Compression Input Power 2 ^{Note 3} | P _{in (1 dB) 2} | f = 0.5 to 3.8 GHz ^{Note 1} V _{cont} = 5 V | - | +37 | - | dBm |
| 2nd Harmonics | 2f ₀ | f = 2.5 GHz, P _{in} = +26 dBm | - | 75 | - | dBc |
| 3rd Harmonics | 3f ₀ | f = 2.5 GHz, P _{in} = +26 dBm | - | 80 | - | dBc |
| Input 3rd Order Intercept Point | IIP ₃ | f = 2.5 GHz | - | +60 | - | dBm |
| Switch Control Current | I _{cont} | No RF input | - | 0.1 | 10 | μA |
| Switch Control Speed | t _{sw} | 50% CTL to 90/10% RF | - | 100 | 250 | ns |

Notes 1. DC blocking capacitors = 56 pF at f = 0.5 to 2.0 GHz

2. P_{in (0.1 dB)} is the measured input power level when the insertion loss increases 0.1 dB more than that of the linear range.

3. P_{in (1 dB)} is the measured input power level when the insertion loss increases 1 dB more than that of the linear range.

Caution It is necessary to use DC blocking capacitors with this device.

EVALUATION CIRCUIT

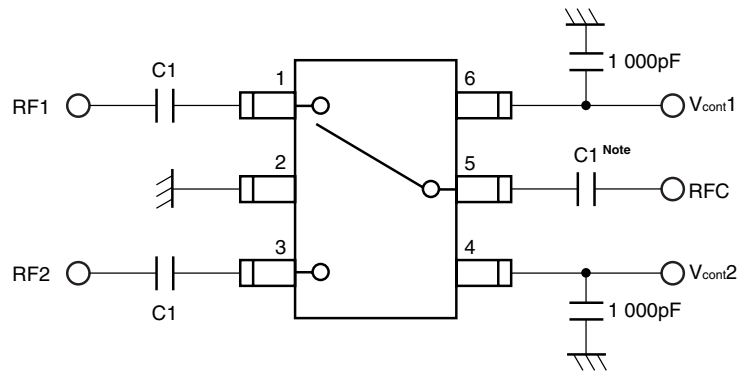

Note C1 : 0.5 to 2.0 GHz 56 pF
 : 2.0 to 3.8 GHz 8 pF

The application circuits and their parameters are for reference only and are not intended for use in actual design-ins.

APPLICATION INFORMATION

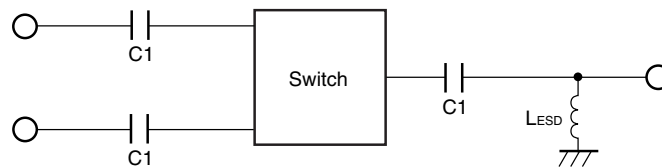

- C1 are DC blocking capacitors external to the device.
 The value may be tailored to provide specific electrical responses.
- The RF ground connections should be kept as short as possible and connected to directly to a good RF ground for best performance.
- L_{ESD} provides a means to increase the ESD protection on a specific RF port, typically the port attached to the antenna.

TYPICAL CHARACTERISTICS

(TA = +25°C, V_{cont} (H) = 2.7 to 5.3 V, V_{cont} (L) = -0.2 to 0.2V, unless otherwise specified)

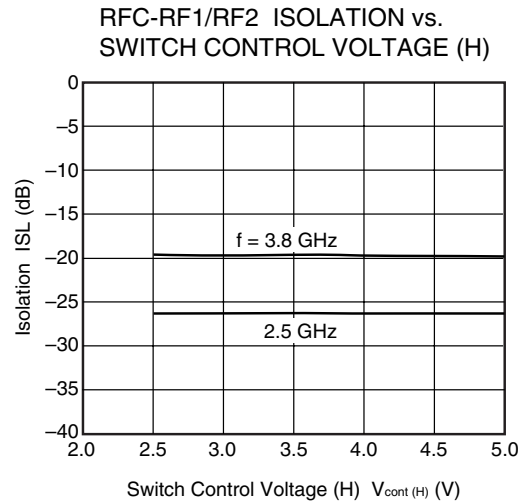
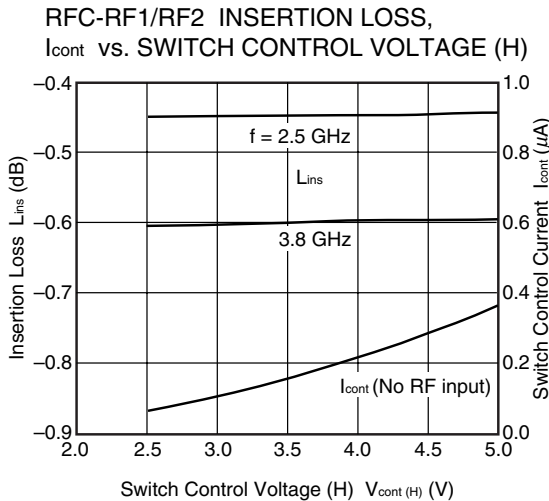
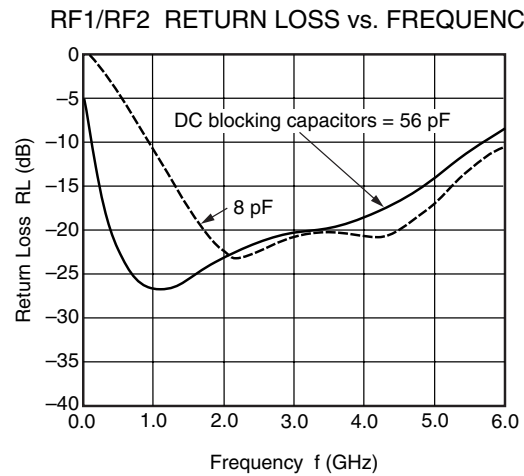
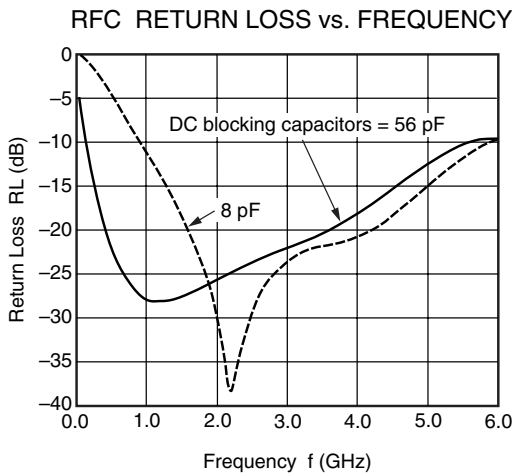
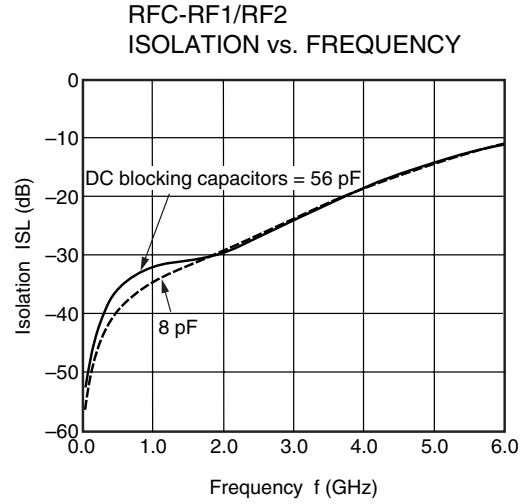
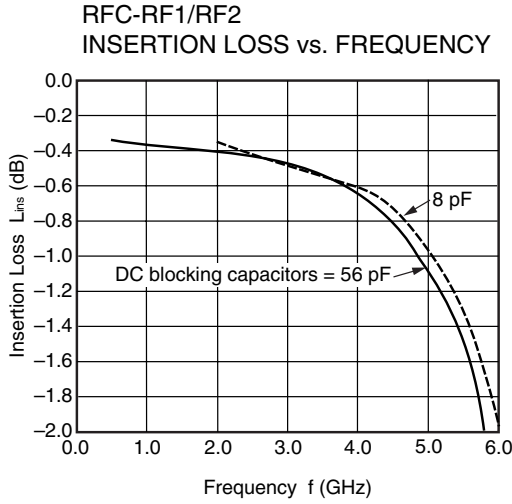

Remark The graphs indicate nominal characteristics.

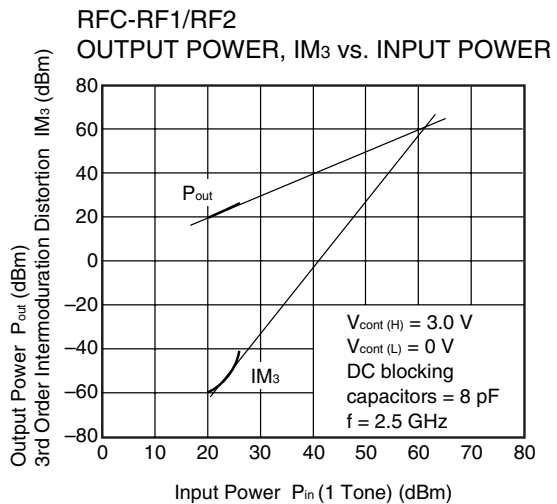
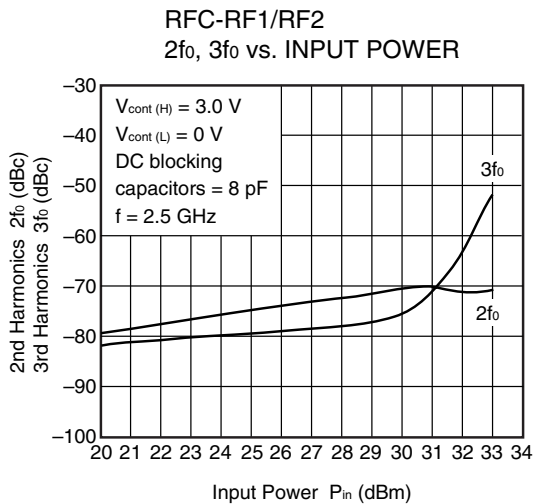
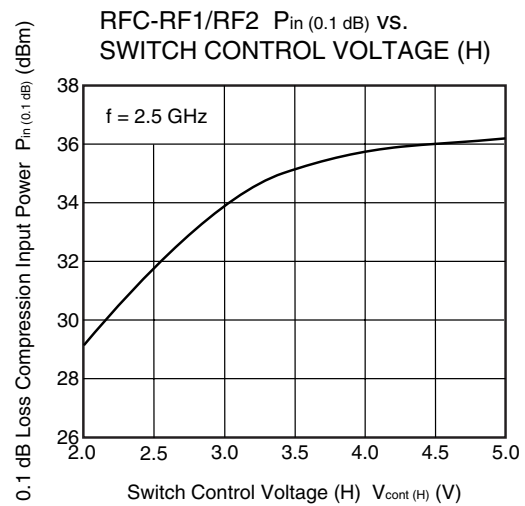
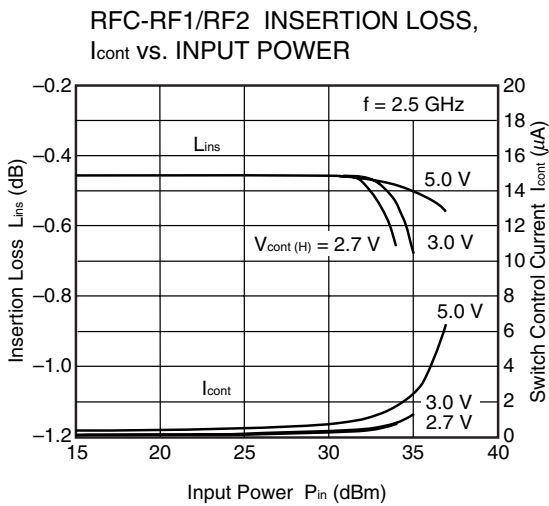
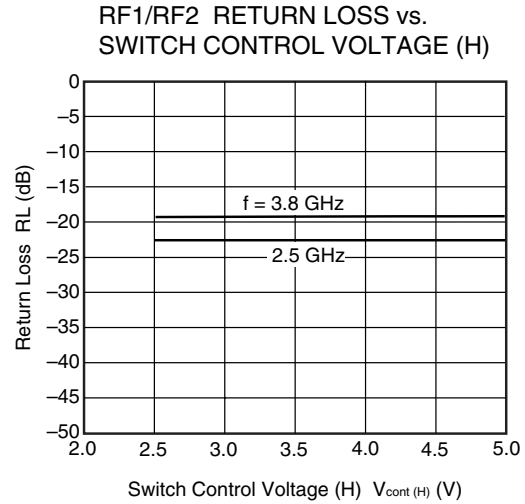
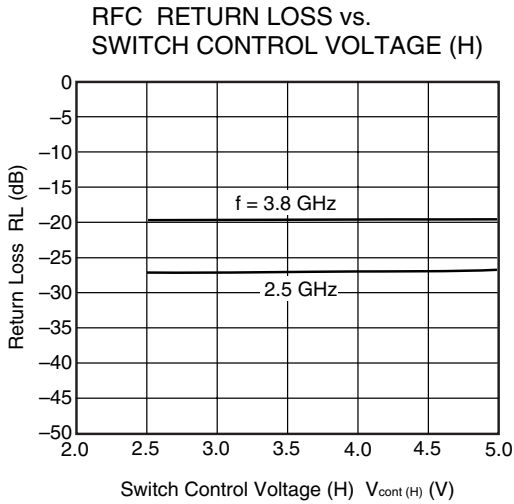

Remark The graphs indicate nominal characteristics.

MOUNTING PAD LAYOUT DIMENSIONS

6-PIN SUPER MINIMOLD (SC-88/SOT-363 type) (UNIT: mm)

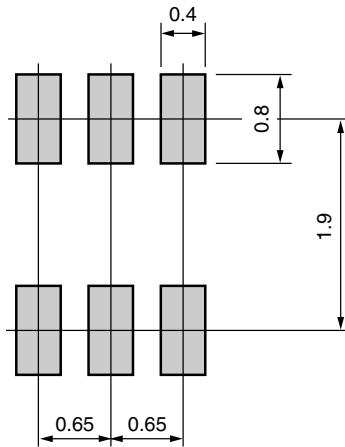

Remark The mounting pad layout in this document is for reference only.
 When designing PCB, please consider workability of mounting, solder joint reliability, prevention of solder bridge and so on, in order to optimize the design.

PACKAGE DIMENSIONS

6-PIN SUPER MINIMOLD (SC-88/SOT-363 type) (UNIT: mm)

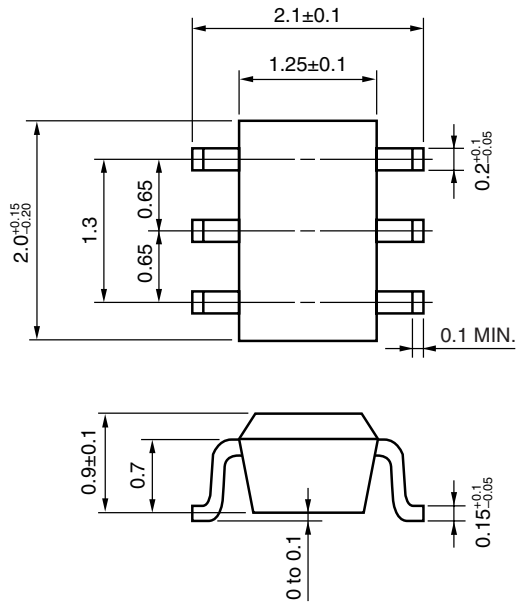

RECOMMENDED SOLDERING CONDITIONS

This product should be soldered and mounted under the following recommended conditions. For soldering methods and conditions other than those recommended below, contact your nearby sales office.

| Soldering Method | Soldering Conditions | Condition Symbol |
|------------------|------------------------------------------------------|----------------------|
| Infrared Reflow | Peak temperature (package surface temperature) | : 260°C or below |
| | Time at peak temperature | : 10 seconds or less |
| | Time at temperature of 220°C or higher | : 60 seconds or less |
| | Preheating time at 120 to 180°C | : 120±30 seconds |
| | Maximum number of reflow processes | : 3 times |
| | Maximum chlorine content of rosin flux (% mass) | : 0.2%(Wt.) or below |
| Wave Soldering | Peak temperature (molten solder temperature) | : 260°C or below |
| | Time at peak temperature | : 10 seconds or less |
| | Preheating temperature (package surface temperature) | : 120°C or below |
| | Maximum number of flow processes | : 1 time |
| | Maximum chlorine content of rosin flux (% mass) | : 0.2%(Wt.) or below |
| Partial Heating | Peak temperature (terminal temperature) | : 350°C or below |
| | Soldering time (per side of device) | : 3 seconds or less |
| | Maximum chlorine content of rosin flux (% mass) | : 0.2%(Wt.) or below |

Caution Do not use different soldering methods together (except for partial heating).

WiMAX is a trademark or a registered trademark of the WiMAX Forum.

- **The information in this document is current as of July, 2009. The information is subject to change without notice. For actual design-in, refer to the latest publications of NEC Electronics data sheets, etc., for the most up-to-date specifications of NEC Electronics products. Not all products and/or types are available in every country. Please check with an NEC Electronics sales representative for availability and additional information.**

- No part of this document may be copied or reproduced in any form or by any means without the prior written consent of NEC Electronics. NEC Electronics assumes no responsibility for any errors that may appear in this document.
- NEC Electronics does not assume any liability for infringement of patents, copyrights or other intellectual property rights of third parties by or arising from the use of NEC Electronics products listed in this document or any other liability arising from the use of such products. No license, express, implied or otherwise, is granted under any patents, copyrights or other intellectual property rights of NEC Electronics or others.
- Descriptions of circuits, software and other related information in this document are provided for illustrative purposes in semiconductor product operation and application examples. The incorporation of these circuits, software and information in the design of a customer's equipment shall be done under the full responsibility of the customer. NEC Electronics assumes no responsibility for any losses incurred by customers or third parties arising from the use of these circuits, software and information.
- While NEC Electronics endeavors to enhance the quality and safety of NEC Electronics products, customers agree and acknowledge that the possibility of defects thereof cannot be eliminated entirely. In addition, NEC Electronics products are not taken measures to prevent radioactive rays in the product design. When customers use NEC Electronics products with their products, customers shall, on their own responsibility, incorporate sufficient safety measures such as redundancy, fire-containment and anti-failure features to their products in order to avoid risks of the damages to property (including public or social property) or injury (including death) to persons, as the result of defects of NEC Electronics products.
- NEC Electronics products are classified into the following three quality grades: "Standard", "Special" and "Specific".

The "Specific" quality grade applies only to NEC Electronics products developed based on a customer-designated "quality assurance program" for a specific application. The recommended applications of an NEC Electronics product depend on its quality grade, as indicated below. Customers must check the quality grade of each NEC Electronics product before using it in a particular application.

"Standard": Computers, office equipment, communications equipment, test and measurement equipment, audio and visual equipment, home electronic appliances, machine tools, personal electronic equipment and industrial robots.

"Special": Transportation equipment (automobiles, trains, ships, etc.), traffic control systems, anti-disaster systems, anti-crime systems, safety equipment and medical equipment (not specifically designed for life support).

"Specific": Aircraft, aerospace equipment, submersible repeaters, nuclear reactor control systems, life support systems and medical equipment for life support, etc.

The quality grade of NEC Electronics products is "Standard" unless otherwise expressly specified in NEC Electronics data sheets or data books, etc. If customers wish to use NEC Electronics products in applications not intended by NEC Electronics, they must contact an NEC Electronics sales representative in advance to determine NEC Electronics' willingness to support a given application.

(Note)

- (1) "NEC Electronics" as used in this statement means NEC Electronics Corporation and also includes its majority-owned subsidiaries.
- (2) "NEC Electronics products" means any product developed or manufactured by or for NEC Electronics (as defined above).

M8E0904E

| | | |
|----------------|---------------|----------------------------------------------------------------------------------------------------------------------------------------------------------------------------------------------------------------------------------------------------------------------------------------------------------------------------------------------------------------------------------------------------------------------------------------------------------------------------------------------------------------------------------------------------------------------------------------------------------------------------------------------------------------------------------------------------------------------------------------------------------------------------------------------------------------------------------------------------------------------------------------------------------------------------------------------------------------------------------------|
| Caution | GaAs Products | <p>This product uses gallium arsenide (GaAs). GaAs vapor and powder are hazardous to human health if inhaled or ingested, so please observe the following points.</p> <ul style="list-style-type: none">• Follow related laws and ordinances when disposing of the product. If there are no applicable laws and/or ordinances, dispose of the product as recommended below.<ol style="list-style-type: none">1. Commission a disposal company able to (with a license to) collect, transport and dispose of materials that contain arsenic and other such industrial waste materials.2. Exclude the product from general industrial waste and household garbage, and ensure that the product is controlled (as industrial waste subject to special control) up until final disposal.• Do not burn, destroy, cut, crush, or chemically dissolve the product.• Do not lick the product or in any way allow it to enter the mouth. |
|----------------|---------------|----------------------------------------------------------------------------------------------------------------------------------------------------------------------------------------------------------------------------------------------------------------------------------------------------------------------------------------------------------------------------------------------------------------------------------------------------------------------------------------------------------------------------------------------------------------------------------------------------------------------------------------------------------------------------------------------------------------------------------------------------------------------------------------------------------------------------------------------------------------------------------------------------------------------------------------------------------------------------------------|