



# EN5365QI

6A Voltage Mode Synchronous Buck PWM  
DC-DC Converter with Integrated Inductor  
3-Pin VID Output Voltage Select

RoHS Compliant  
Halogen Free

## Description

This Enpirion solution is a Power System on Silicon DC-DC converter. It is specifically designed to meet the precise voltage and fast transient requirements of present and future high-performance, low-power processor, DSP, FPGA, ASIC, memory boards and system level applications in a distributed power architecture. Advanced circuit techniques, ultra high switching frequency, and very advanced, high-density, integrated circuit and proprietary inductor technology deliver high-quality, ultra compact, non-isolated DC-DC conversion. Operating this converter requires as few as three external components that include small value input and output ceramic capacitors and a soft-start capacitor.

The Enpirion integrated inductor solution significantly helps in low noise system design and productivity by offering greatly simplified board design, layout and manufacturing requirements.

All Enpirion products are RoHS compliant and lead-free manufacturing environment compatible.

## Typical Application Circuit

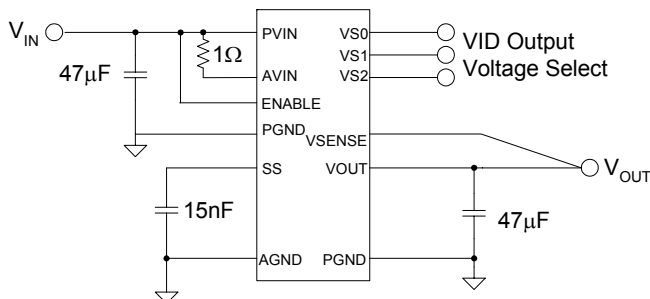

Figure 1. Simple Layout.

## Features

- Integrated INDUCTOR, MOSFETS, Controller
- Footprint 1/3<sup>rd</sup> that of competing solutions.
- Low Part Count: only 3 MLCC Capacitors.
- Up to 20W continuous output power.
- Low output impedance optimized for  $\leq 90$  nm
- Master/slave configuration for paralleling.
- 5MHz operating frequency.
- High efficiency, up to 93%.
- Wide input voltage range of 2.375V to 5.5V.
- 3-pin VID output voltage select to chose one of 7 pre-programmed Output Voltages.
- Output enable pin and Power OK signal.
- Programmable soft-start time.
- Optimized for low noise/EMI design.
- Thermal shutdown, short circuit, over-voltage and under-voltage protection.
- RoHS compliant, MSL level 3, 260C reflow.

## Applications

- Point of load regulation for low-power processors, network processors, DSPs, FPGAs, and ASICs
- $\leq 90$  nm advanced process loads
- Notebook computers, servers, workstations
- Broadband, networking, LAN/WAN, optical
- Low voltage, distributed power architectures with 2.5V, 3.3V or 5V rails
- DSL, STB, DVR, DTV, Industrial PC
- Ripple sensitive applications

## Ordering Information

Part Number	Temp Rating (°C)	Package
EN5365QI-T	-40 to +85	58-pin QFN T&R
EN5365QI-E		QFN Evaluation Board

\*Optimized PCB Layout file downloadable from the Enpirion Website to assure first pass design success.

## Pin Configuration

Below is a top view diagram of the EN5365Q package.

NOTE: NC pins are not to be electrically connected to each other or to any external signal, ground, or voltage. However, they must be soldered to the PCB. Failure to follow this guideline may result in part malfunction or damage.

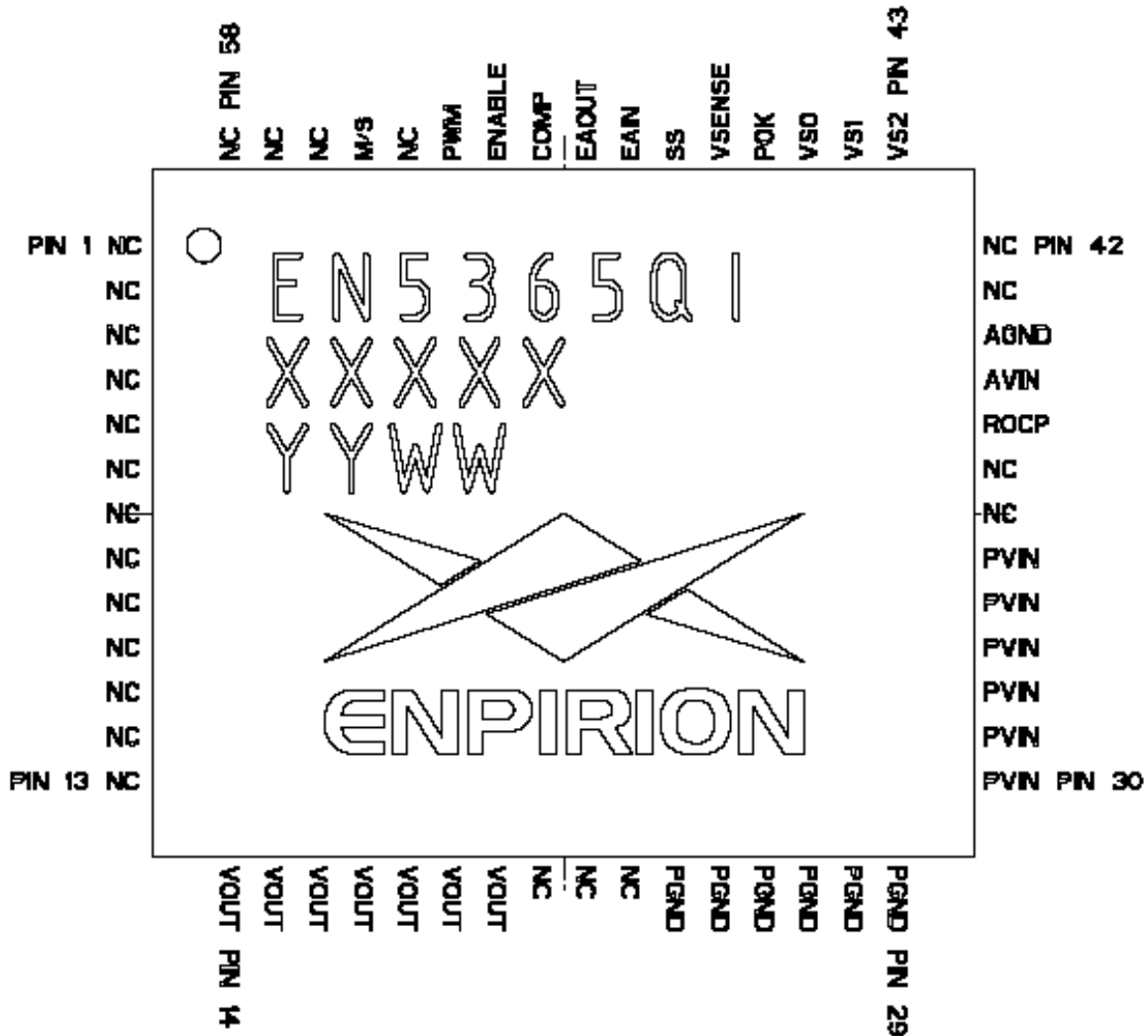

Figure 2. Pin Diagram, top view.

## Pin Descriptions

PIN	NAME	FUNCTION
1-3	NC	NO CONNECT: These pins should not be electrically connected to each other or to any external signal, voltage, or ground. One or more of these pins may be connected internally.
4-5	NC	NO CONNECT: These pins should not be electrically connected to each other or to any external signal, voltage, or ground. CAUTION!: Internally connected to switching node. Take care to route signals away from these pins.
6-13	NC	NO CONNECT: These pins should not be electrically connected to each other or to any external signal, voltage, or ground. One or more of these pins may be connected internally.
14-20	VOUT	Regulated converter output. Decouple with output filter capacitor to PGND. Refer to layout section for specific layout requirements
21-23	NC	NO CONNECT: These pins should not be electrically connected to each other or to any external signal, voltage, or ground. CAUTION!: Internally connected to switching node. Take care to route signals away from these pins.
24-29	PGND	Output power ground. Refer to layout section for specific layout requirements.
30-35	PVIN	Input power supply. Connect to input power supply. Decouple with input capacitor to PGND. Refer to layout section for specific layout requirements
36-37	NC	NO CONNECT: These pins should not be electrically connected to each other or to any external signal, voltage, or ground. One or more of these pins may be connected internally.
38	ROCP	Optional Over Current Protection adjust pin. Used for diagnostic purposes only. Place 10k $\Omega$ resistor between this pin and AGND (pin 40) to raise the over current trip point to approximately 200% of maximum rated current.
39	AVIN	Analog voltage input for the controller circuits. Connect this pin to PVIN using a 1 Ohm resistor.
40	AGND	Analog ground for the controller circuits.
41-42	NC	NO CONNECT: These pins should not be electrically connected to each other or to any external signal, voltage, or ground. One or more of these pins may be connected internally.
43	VS2	Voltage select line 2 input. See Table 1. This pin has internal pull-up
44	VS1	Voltage select line 1 input. See Table 1. This pin has internal pull-up
45	VS0	Voltage select line 0 input. See Table 1. This pin has internal pull-up
46	POK	Power OK is an open drain transistor for power system state indication. POK is a logic high when VOUT is with -10% to +20% of VOUT nominal. Size pull-up resistor to limit current to 4mA when POK is low.
47	VSENSE	Output Voltage Sense. Connect to output voltage immediately downstream from the output filter capacitors.
48	SS	Soft-Start node. The soft-start capacitor is connected between this pin and AGND. The value of this capacitor determines the startup timing.
49	EAIN	Optional Error Amplifier input. Allows for customization of the control loop.
50	EAOUT	Optional Error Amplifier output. Allows for customization of the control loop.
51	COMP	Optional Error Amplifier Buffer output. Allows for customization of the control loop.
52	ENABLE	Input Enable. Applying a logic high, enables the output and initiates a soft-start. Applying a logic low disables the output.

PIN	NAME	FUNCTION
53	PWM	PWM input/output. Used for optional master/slave configuration. When M/S pin is asserted "low", PWM will output the gate-drive PWM waveform. When the M/S pin is asserted "high", the PWM pin is configured as an input for PWM signal from the "master" device. PWM pin can drive up to 3 slave devices. NOTE: Leave this pin open when not using parallel mode.
54	NC	NO CONNECT: These pins should not be electrically connected to each other or to any external signal, voltage, or ground. One or more of these pins may be connected internally.
55	M/S	Optional Master/Slave select pin. Asserting pin "low" places device in Master Mode for current sharing. PWM pin (53) will output PWM drive signal. Asserting pin "high" will place the device in Slave Mode. PWM pin (53) will be configured to input (receive) PWM drive signal from "Master" device. NOTE: Leave this pin open when not using parallel mode.
56-58	NC	NO CONNECT: These pins should not be electrically connected to each other or to any external signal, voltage, or ground. One or more of these pins may be connected internally.

## Block Diagram

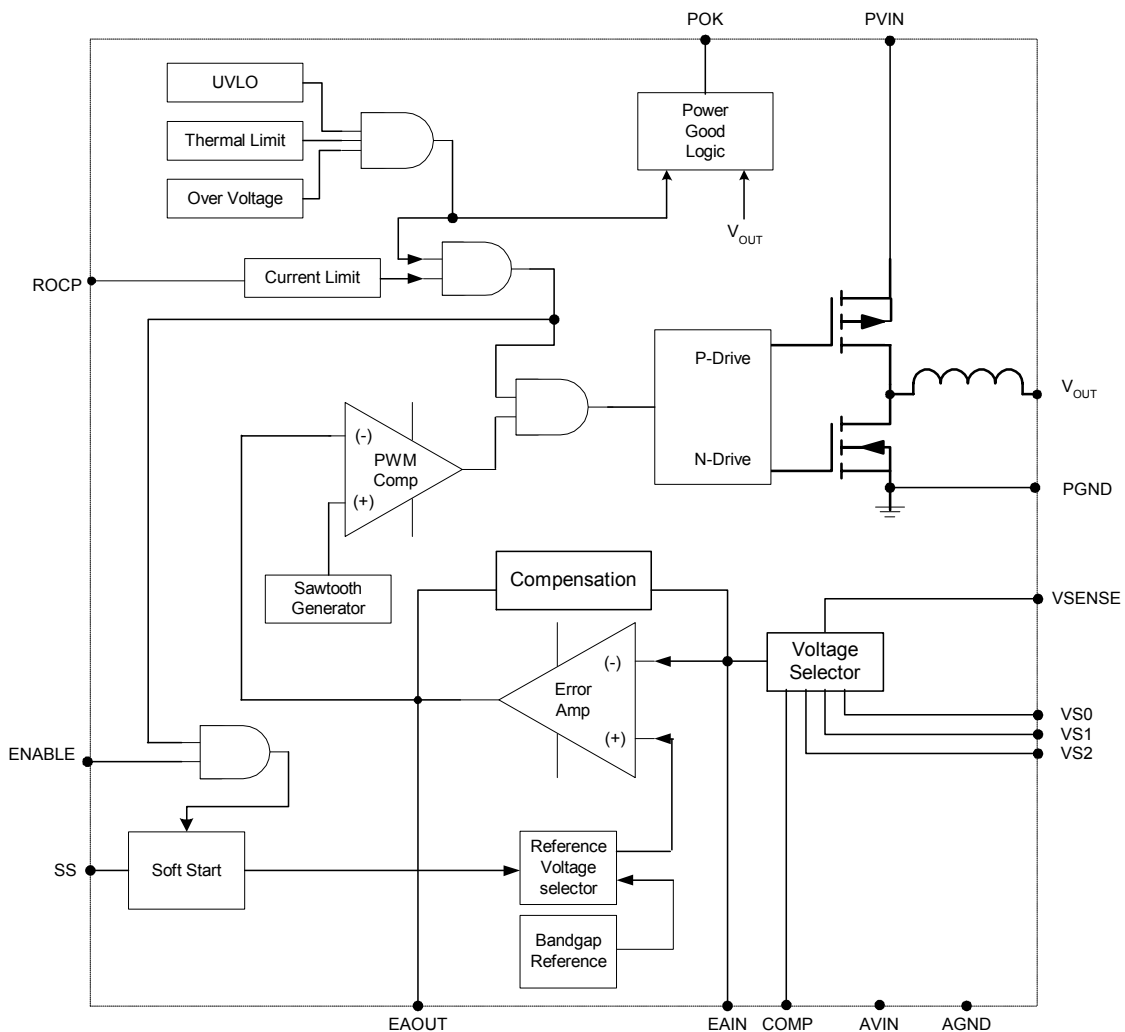

Figure 3. System block diagram.

## Absolute Maximum Ratings

CAUTION: Absolute Maximum ratings are stress ratings only. Functional operation beyond recommended operating conditions is not implied. Stress beyond absolute maximum ratings may cause permanent damage to the device. Exposure to absolute maximum rated conditions for extended periods may affect device reliability.

PARAMETER	SYMBOL	MIN	MAX	UNITS
Input Supply Voltage	$V_{IN}$	-0.5	7.0	V
Voltages on: ENABLE, $V_{SENSE}$ , $V_{S2}-V_{S0}$ , M/S (Note 1)		-0.5	$V_{IN}$	V
Voltages on: EAIN, EAOUT, COMP		-0.5	2.5	V
Voltages on: SS, PWM		-0.5	3.0	V
Voltages on: POK		-0.5	$V_{IN} + 0.3$	V
Storage Temperature Range	$T_{STG}$	-65	150	°C
Reflow Temp, 10 Sec, MSL3 JEDEC J-STD-020A			260	°C
ESD Rating (based on Human Body Model)			2000	V

### NOTES:

1. VS0, VS1 and VS2 pins have an internal pull-up resistor, only ground potentials should be placed on them as required.

## Recommended Operating Conditions

PARAMETER	SYMBOL	MIN	MAX	UNITS
Input Voltage Range	$V_{IN}$	2.375	5.5	V
Output Voltage Range	$V_{OUT}$	0.75	3.3	V
Operating Ambient Temperature	$T_A$	-40	+85	°C
Operating Junction Temperature	$T_J$	-40	+125	°C

## Thermal Characteristics

PARAMETER	SYMBOL	TYP	UNITS
Thermal Resistance: Junction to Ambient (0 LFM) (Note 2)	$\theta_{JA}$	20	°C/W
Thermal Resistance: Junction to Case (0 LFM)	$\theta_{JC}$	1.5	°C/W
Thermal Overload Trip Point	$T_{J-TP}$	+150	°C
Thermal Overload Trip Point Hysteresis		20	°C

### NOTES:

2. Based on a four-layer board and proper thermal design in line with JEDEC EIJ/JESD 51 Standards.

## Electrical Characteristics

NOTE:  $V_{IN}=5.5V$  over operating temperature range unless otherwise noted.

Typical values are at  $T_A = 25^\circ C$ .

PARAMETER	SYMBOL	TEST CONDITIONS	MIN	TYP	MAX	UNITS
Input Voltage	$V_{IN}$		2.375		5.5	V
<b>Output Regulation</b>						
Initial Accuracy	$V_{OUT}$	$2.375V \leq V_{IN} \leq 5.5V$ , $I_{LOAD} = 1A$ ; $T_A = 25^\circ C$	-2.0		+2.0	%
Variation due to all causes	$V_{OUT}$	$2.375V \leq V_{IN} \leq 5.5V$ , $0A \leq I_{LOAD} \leq 6A$ $-40^\circ C \leq T_A \leq +85^\circ C$	-3.0		+3.0	%
<b>Transient Response (<math>I_{OUT} = 0\%</math> to <math>100\%</math> or <math>100\%</math> to <math>0\%</math> of Rated Load)</b>						
Peak Deviation	$\Delta V_{OUT}$	$V_{IN} = 5V$ , $1.2V < V_{OUT} < 3.3V$ , $C_{OUT} = 50\mu F$		3		%
<b>Output Voltage Ripple</b>						
Peak-to-peak	$\Delta V_{OUT-PP}$	$V_{IN} = 5.0V$ , $V_{OUT} = 1.2V$ , $I_{OUT} = 6A$ , $C_{OUT} = 5 \times 10\mu F$ X5R or X7R MLCC		<20		mV
<b>Under Voltage Lockout</b>						
Under Voltage Lock out threshold	$V_{UVLO}$	$V_{IN}$ Increasing $V_{IN}$ Decreasing		2.2 2.1		V
<b>Switching Frequency</b>						
Switching Frequency	$F_{SWITCH}$			5		MHz
<b>Load Characteristics</b>						
Maximum Continuous Output Current	$I_{OUT}$	(Note 3)	6			A
Current Limit Threshold	$I_{OCP\_TH}$			9		A
<b>Supply Current</b>						
Shut-Down Supply Current	$I_S$	ENABLE=0V		50		$\mu A$
<b>Enable Operation</b>						
Disable Threshold	$V_{DISABLE}$	Max voltage to ensure the converter is disabled			0.8	V
Enable Threshold	$V_{ENABLE}$	$2.375V \leq V_{IN} \leq 5.5V$	1.8			V
Enable Pin Current	$I_{EN}$	$V_{IN} = 5.5V$		50		$\mu A$

PARAMETER	SYMBOL	TEST CONDITIONS	MIN	TYP	MAX	UNITS
<b>Voltage Select Operation</b>						
Logic Low Threshold	$V_{SX-Low}$	Threshold voltage for Logic Low			0.8	V
Logic High Threshold	$V_{SX-High}$	Threshold voltage for Logic High (internally pulled high; can be left floating to achieve logic high)	1.8		$V_{IN}$	V
$V_{SX}$ Pin Current	$I_{VSX}$	$V_{IN} = 5.5V$ $V_{SX} = GND$ $V_{SX} = V_{IN}$ $V_{SX} = Open$		50 0 0		$\mu A$
<b>Power OK Operation (Open Drain)</b>						
POK threshold High		Percentage of $V_{OUT}$ Nominal		120		%
POK threshold low		Percentage of $V_{OUT}$ Nominal		90		%
POK Low Voltage		$I_{POK} = 4\text{ mA}$ (Max sink Current)			0.4	V
POK High Voltage					$V_{IN}$	%
<b>Output Rise Time</b>						
$V_{OUT}$ Rise Time Accuracy	$\Delta T_{RISE}$	$T_{RISE} = C_{SS} * 75K\Omega$ ; $10nF \leq C_{SS} \leq 30nF$ <b>(Note 4)</b>	-25		+25	%
<b>Parallel Operation</b>						
Current Balance	$\Delta I_{OUT}$	With 2 – 4 converters in parallel, the difference between any 2 parts. $\Delta V_{IN} < 50mV$ ; $R_{TRACE} < 10m\Omega$ .		+/-10		%

NOTES:

- Maximum output current may need to be de-rated, based on operating condition, to meet  $T_J$  requirements.
- Parameter not production tested but is guaranteed by design. Rise time begins when  $AVIN > V_{UVLO}$  and Enable=HIGH.

**Typical Performance Characteristics**

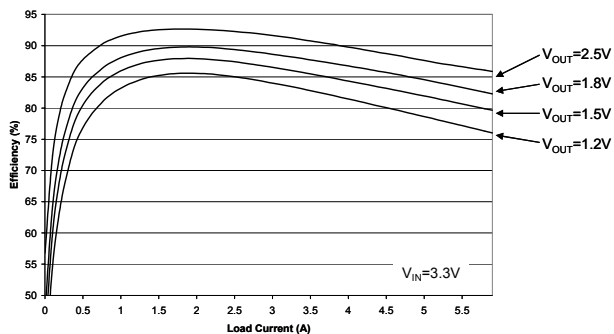

Efficiency vs. Load,  $V_{IN} = 3.3V$ .; Load = 0-6A.

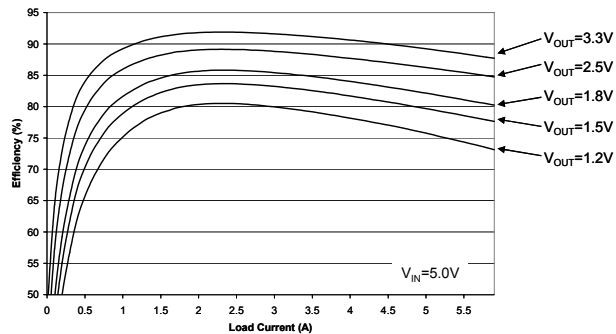

Efficiency vs. Load,  $V_{IN} = 5.0V$ .; Load = 0-6A.

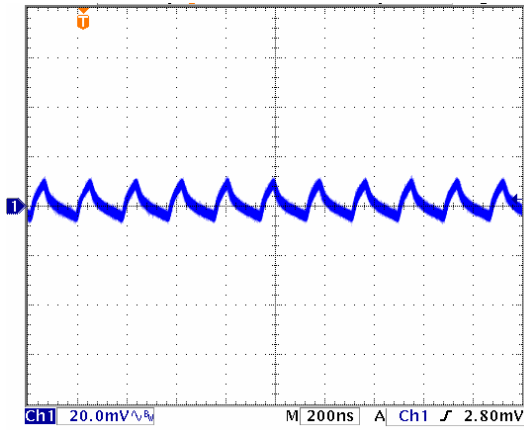

Ripple Voltage, 5.0V<sub>IN</sub>/1.2V<sub>OUT</sub>, I<sub>OUT</sub>=6A,  
C<sub>OUT</sub> = 5x10uF.

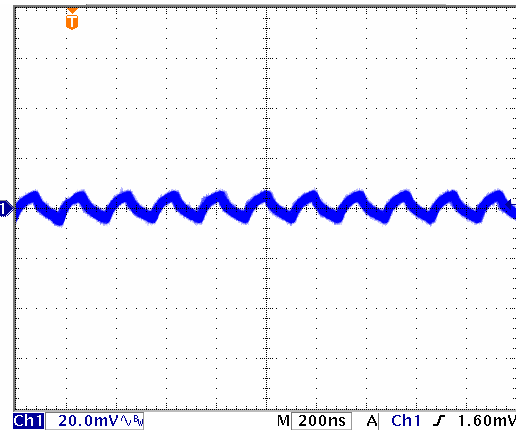

Ripple Voltage, 3.3V<sub>IN</sub>/1.2V<sub>OUT</sub>, I<sub>OUT</sub>=6A,  
C<sub>OUT</sub> = 5x10uF.

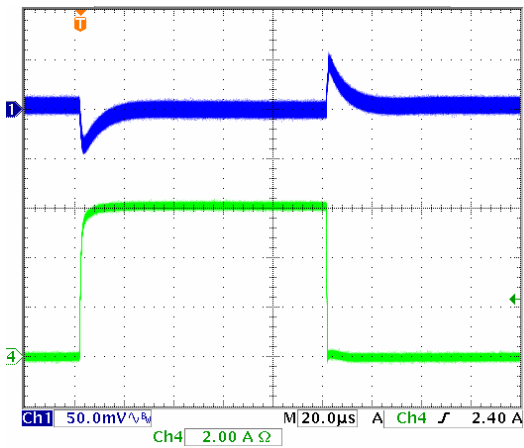

Transient Response 5.5V<sub>IN</sub>/1.2V<sub>OUT</sub>, 0-6A, 10A/uS.  
C<sub>OUT</sub> = 50uF

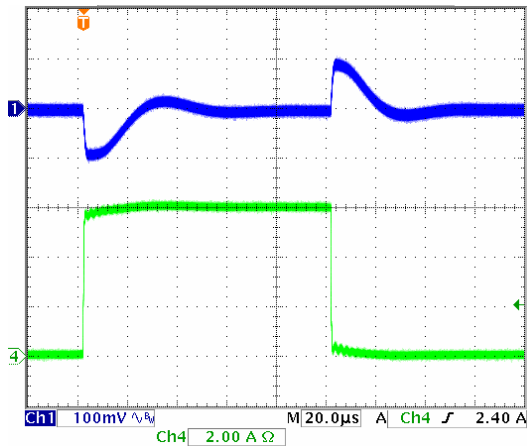

Transient Response 5.5V<sub>IN</sub>/3.3V<sub>OUT</sub>, 0-6A, 10A/uS.  
C<sub>OUT</sub> = 50uF

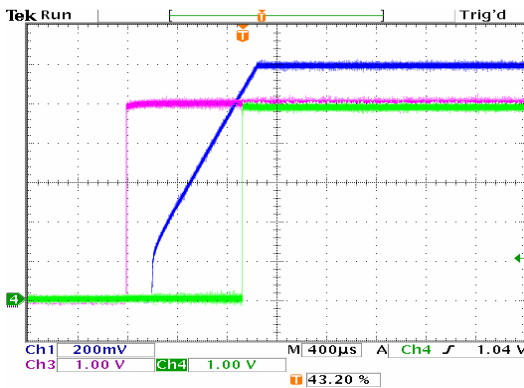

Start up waveforms V<sub>IN</sub>=5.0V, V<sub>OUT</sub>=1.2V, C<sub>SS</sub>=15nF,  
Ch 1 = V<sub>OUT</sub>, Ch 3 = ENABLE, Ch 4 = POK.

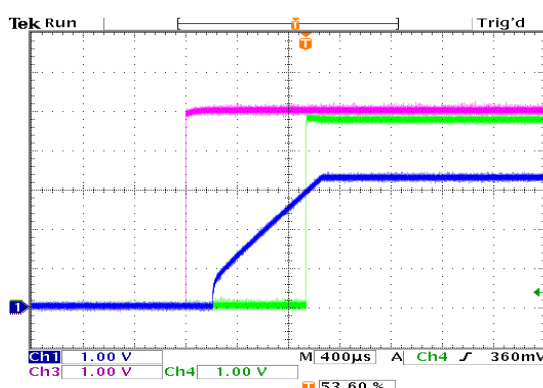

Start up waveforms V<sub>IN</sub>=5.0V, V<sub>OUT</sub>=3.3V, C<sub>SS</sub>=15nF,  
Ch 1 = V<sub>OUT</sub>, Ch 3 = ENABLE, Ch 4 = POK.



## Theory of Operation

### Synchronous Buck Converter

The EN5365QI is a synchronous, pin programmable power supply with integrated power MOSFET switches and integrated inductor. The nominal input voltage range is 2.375-5.5V. The output can be set to common pre-set voltages by connecting appropriate combinations of 3 voltage selection pins to ground. The feedback control loop is a type III voltage-mode and the part uses a low-noise PWM topology. Up to 6A of output current can be drawn from this converter. The 5MHz operating frequency enables the use of small-size output capacitors.

The power supply has the following protection features:

- Programmable over-current protection (to protect the IC from excessive load current)
- Thermal shutdown with hysteresis.
- Over-voltage protection
- Under-voltage lockout circuit to disable the converter output when the input voltage is less than approximately 2.2V

Additional features include:

- Soft-start circuit, limiting the in-rush current when the converter is powered up.
- Power good circuit indicating whether the output voltage is within 90%-120% of the programmed voltage.

### Output Voltage Programming

The EN5365QI output voltage is programmed using a 3-pin voltage-ID or VID selector. Three binary VID pins allow the user to choose one of seven pre-set voltages. Refer to table 1 for the proper VID pin settings to program  $V_{OUT}$ .

The voltage select pins, VS0, VS1, and VS2, are pulled-up internally and so will default to a logic high, or "1", if left "open". Connecting the voltage select pin to ground will result in a logic "0".

Table 1: Output Voltage Select Table

VS2*	VS1*	VS0*	Output Voltage
0	0	0	3.3V
0	0	1	2.5V
0	1	0	1.8V
0	1	1	1.5V
1	0	0	1.25V
1	0	1	1.2V
1	1	0	0.8V
1	1	1	Reserved

### Input Capacitor Selection

The EN5365QI requires between 40-80uF of input capacitance. Low ESR ceramic capacitors are required with X5R or X7R dielectric formulation. Y5V or equivalent dielectric formulations must not be used as these lose capacitance with frequency, temperature and bias voltage.

In some applications, lower value ceramic capacitors maybe needed in parallel with the larger capacitors in order to provide high frequency decoupling.

Table 2. Recommended input capacitors.

Description	MFG	P/N
22uF, 10V, X5R, 1210	Murata	GRM32ER71A226KE20L
	Taiyo Yuden	LMK325BJ226KM-T
47uF, 10V, X5R, 1210	Murata	GRM32ER71A476KE20L
	Taiyo Yuden	LMK325BJ476KM-T

### Output Capacitor Selection

The EN5365QI has been optimized for use with approximately 50uF of output capacitance. Low ESR ceramic capacitors are required with X5R or X7R dielectric formulation. Y5V or equivalent dielectric formulations must not be used as these lose capacitance with frequency, temperature and bias voltage.

Table 3. Recommended output capacitors.

Description	MFG	P/N
10uF, 6.3V, X5R, 1206	Murata	GRM319R60J106KE19D
	Taiyo Yuden	LMK316BJ106KD-T
22uF, 6.3V, X5R, 1206	Murata	GRM31CR60J226KE19L
	Taiyo Yuden	LMK316BJ226KL-T
47uF, 6.3V, X5R, 1206	Murata	GRM31CR71A476ME19L
	Taiyo Yuden	LMK316BJ476KL-T

Output ripple voltage is primarily determined by the aggregate output capacitor impedance. At the 5MHz switching frequency output impedance, denoted as Z, is comprised mainly of effective series resistance, ESR, and effective series inductance, ESL:

$$Z = ESR + ESL.$$

Placing output capacitors in parallel reduces the impedance and will hence result in lower ripple voltage.

$$\frac{1}{Z_{Total}} = \frac{1}{Z_1} + \frac{1}{Z_2} + \dots + \frac{1}{Z_n}$$

Typical ripple versus capacitor arrangement is given below:

Output Capacitor Configuration	Typical Output Ripple (mVp-p) (as measured on EN5365QI Evaluation Board)
1 x 47uF	<30
5 x 10 uF	<20

## Compensation

The EN5365 is internally compensated through the use of a type 3 compensation network and is optimized for use with about 50uF of output capacitance and will provide excellent loop bandwidth and transient performance for most applications. Voltage mode operation provides high noise immunity at light load. Further, Voltage mode control provides superior impedance matching to sub 90nm loads.

In some cases modifications to the compensation may be required. The EN5365QI provides the

capability to modify the control loop to allow for customization for a given application. For more information, contact Enpirion Applications Engineering support.

## Enable Operation

The ENABLE pin provides a means to shut down the device, or enable normal operation. A logic low will disable the converter and cause it to shut down. A logic high will enable the converter into normal operation. When the ENABLE pin is asserted high, the device will undergo a normal soft start.

## Soft-Start Operation

The SS pin in conjunction with a small capacitor between this pin and AGND provides the soft start function to limit the in-rush current during start-up. During start-up of the converter the reference voltage to the error amplifier is gradually increased to its final level by an internal current source of typically 10uA charging the soft start capacitor. The typical soft-start time for the output to reach regulation voltage, from when  $AVIN > V_{UVLO}$  and Enable crosses its logic high threshold, is given by:

$$T_{SS} = C_{SS} * 75K\Omega \text{ (seconds)}$$

Where the soft-start time  $T_{SS}$  is in seconds and the soft-start capacitance  $C_{SS}$  is in Farads. Typically, a capacitor of around 15 nF is recommended.

During the soft-start cycle, when the soft-start capacitor reaches 0.75V, the output has reached its programmed regulation range. Note that the soft-start current source will continue to operate, and during normal operation, the soft-start capacitor will charge up to a final value of 2.5V.

## POK Operation

The POK signal is an open drain signal from the converter indicating the output voltage is within the specified range. The POK signal will be a logic high when the output voltage is within 90% -

120% of the programmed output voltage. If the output voltage goes outside of this range, the POK signal will be a logic low until the output voltage has returned to within this range. In the event of an over-voltage condition the POK signal will go low and will remain in this condition until the output voltage has dropped to 95% of the programmed output voltage before returning to the high state.

The internal POK FET is designed to tolerate up to 4mA. The pull-up resistor value should be chosen to limit the current from exceeding this value when POK is logic low.

### Over-Current Protection

The current limit function is achieved by sensing the current flowing through a sense P-MOSFET. When the sensed current exceeds the current limit, both NFET and PFET switches are turned off. If the over-current condition is removed, the over-current protection circuit will re-enable the PWM operation. If the over-current condition persists, the circuit will continue to protect the load.

The OCP trip point is nominally set to 150% of maximum rated load. For diagnostic purposes, it is possible to increase the OCP trip point to approximately 200% of the maximum rated load by connecting a 10k $\Omega$  resistor between the ROCP pin (pin 38) and AGND (pin 39). This is intended for troubleshooting purposes only and the specification is not guaranteed.

### Over-Voltage Protection

When the output voltage exceeds 120% of the programmed output voltage, the PWM operation stops, the lower N-MOSFET is turned on and the POK signal goes low. When the output voltage drops below 95% of the programmed output voltage, normal PWM operation resumes and POK returns to its high state.

### Thermal Overload Protection

Thermal shutdown will disable operation when the Junction temperature exceeds approximately 150°C. Once the junction temperature drops by approx 20°C, the converter will re-start with a normal soft-start.

### Input Under-Voltage Lock-Out

Circuitry is provided to ensure that when the input voltage is below the required voltage level ( $V_{UVLO}$ ) for normal operation, the converter will not start-up. Circuits for hysteresis and input de-glitch are included to ensure high noise immunity and to prevent false tripping.

### Parallel Device Operation

The EN5365QI is capable of paralleling up to a total of four converters to provide up to 24A of continuous current. Please refer to the Parallel Operation Application note, available on the Enpirion website [www.enpirion.com](http://www.enpirion.com), for details on parallel operation.

## Layout Recommendations

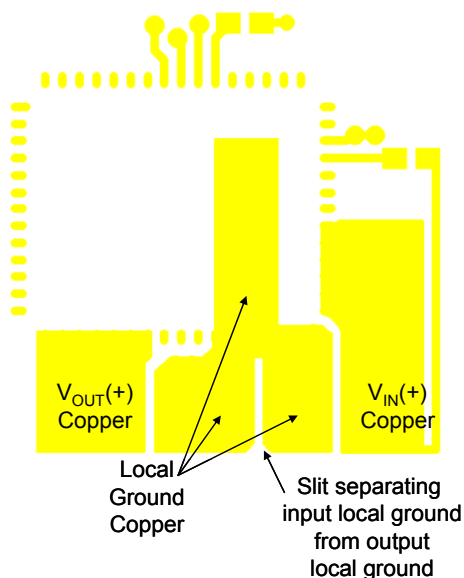

Figure 5. Layout of power and ground copper.

**Recommendation 1:** Input and output filter capacitors should be placed as close to the EN5365QI package as possible to reduce EMI from input and output loop currents. This reduces the physical area of the Input and Output AC current loops.

**Recommendation 2:** Place a slit in the input/output capacitor ground copper starting just below the common connection point of the device GND pins as shown in figures 5 and 6.

**Recommendation 3:** The large thermal pad underneath the component must be connected to the system ground plane through as many vias as possible. The drill diameter of the vias should be less than 0.33mm, and the vias must have at least 1 oz. copper plating on the inside wall, making the finished hole size around 0.26mm. This connection provides the path for heat dissipation from the converter. Please see figures 6, 7, and 8.

**Recommendation 4:** Multiple small vias should be used to connect ground terminal of the input capacitor and output capacitors to the system ground plane as shown in figure 6.

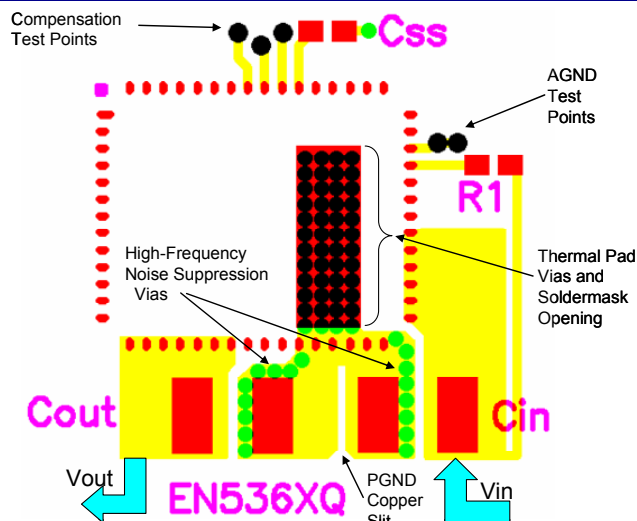

Figure 6. Use of thermal & noise suppression vias.

These vias can be the same size as the thermal vias discussed in recommendation 3.

**Recommendation 5:** The system ground plane referred to in recommendations 3 and 4 should be the first layer immediately below the surface layer. This ground plane should be continuous and un-interrupted below the converter and the input/output capacitors shown in figure 6.

**Recommendation 6:** As with any switch-mode DC/DC converter, do not run sensitive signal or control lines underneath the converter package.

Please refer to the Gerber files and summarized layout notes available on the Enpirion website [www.enpirion.com](http://www.enpirion.com) for more layout details.

**NOTE:** Figures 5 and 6 show only the critical components and traces for a minimum footprint layout. ENABLE, Vout-programming, and other small signal pins need to be connected and routed according to the specific application.

## Design Considerations for Lead-Frame Based Modules

### Exposed Metal on Bottom Of Package

Lead frame offers many advantages in thermal performance, in reduced electrical lead resistance, , and in overall foot print. However, they do require some special considerations.

In the assembly process lead frame construction requires that, for mechanical support, some of the lead-frame cantilevers be exposed at the point where wire-bond or internal passives are attached. This results in several small pads being exposed on the bottom of the package.

Only the large thermal pad and the perimeter pads are to be mechanically or electrically connected to the PC board. The PCB top layer under the EN5365QI should be clear of any metal except for the large thermal pad. The “grayed-out” area in Figure 7 represents the area that should be clear of any metal (traces, vias, or planes), on the top layer of the PCB.

Figure 8 demonstrates the recommended PCB footprint for the EN5365QI. Figure 9 shows the shape and location of the exposed metal pads as well as the mechanical dimension of the large thermal pad and the pins.

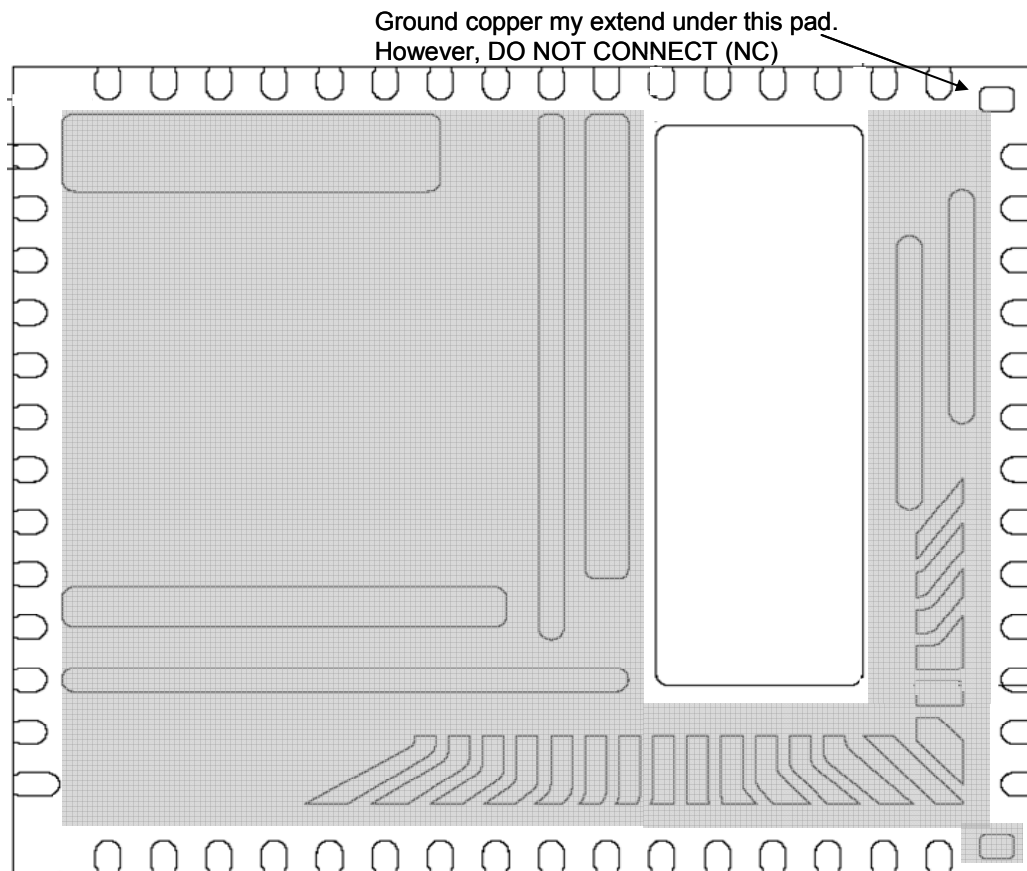

**Figure 7. Lead-Frame exposed metal. Grey area highlights exposed metal that is not to be mechanically or electrically connected to the PCB.**

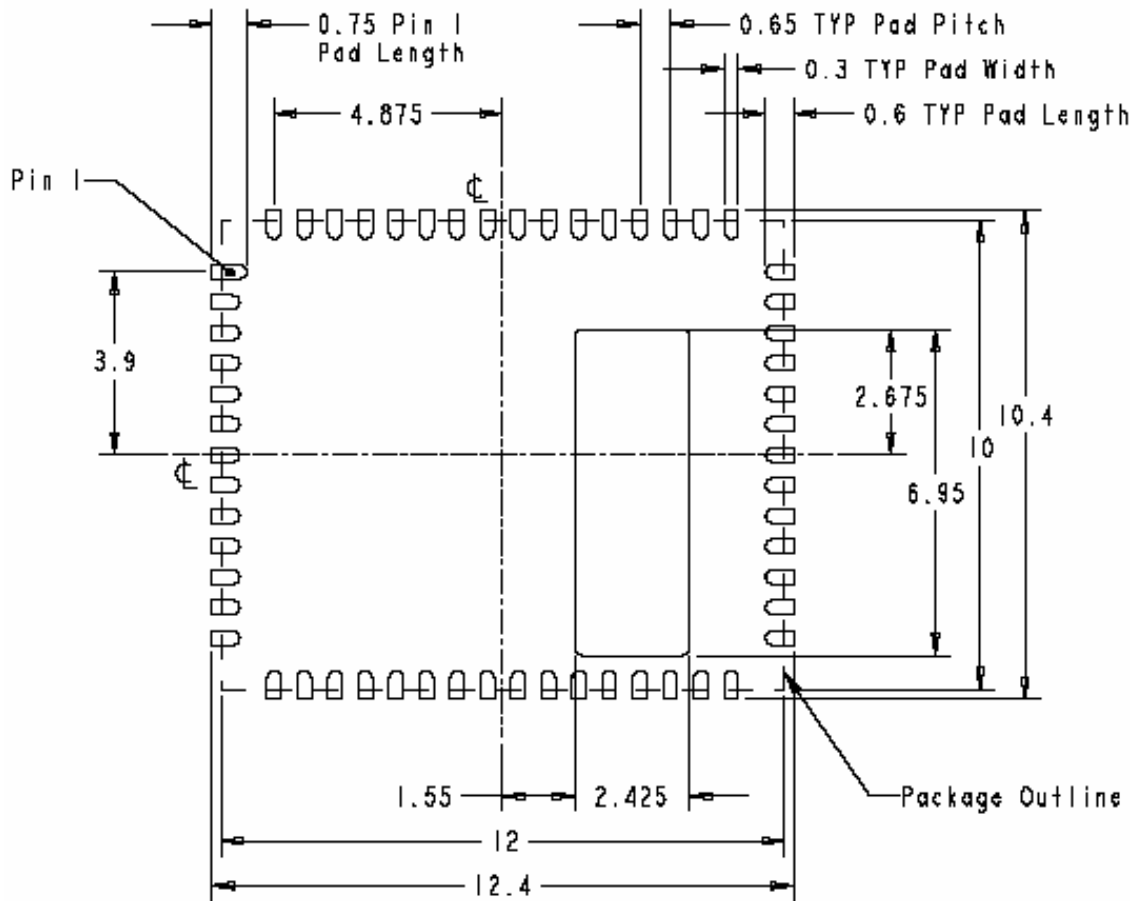
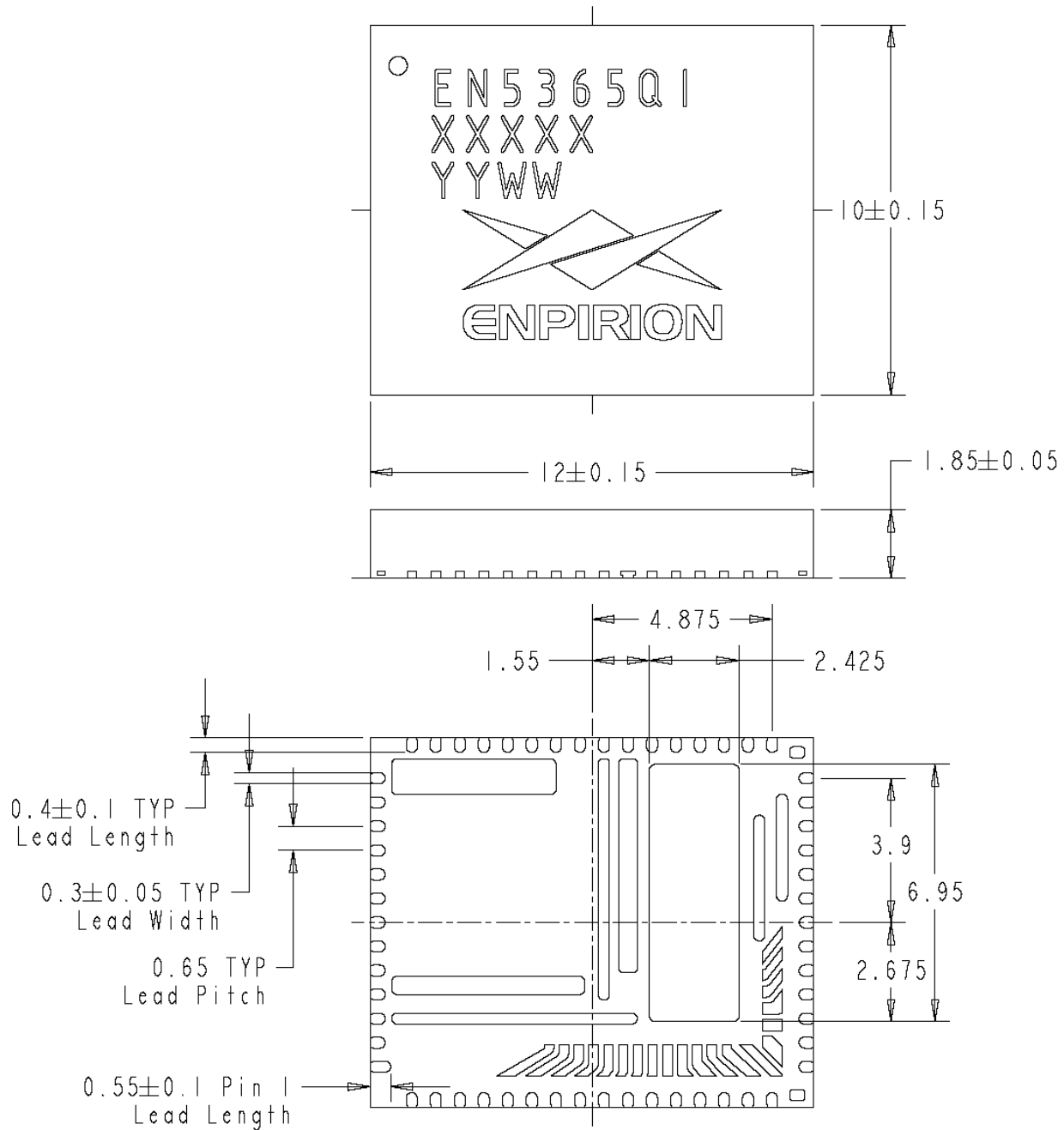

Figure 8. Recommended footprint for PCB.

**Package Dimensions**



**Figure 9. Package dimensions.**



## TAPE AND REEL SPECIFICATION

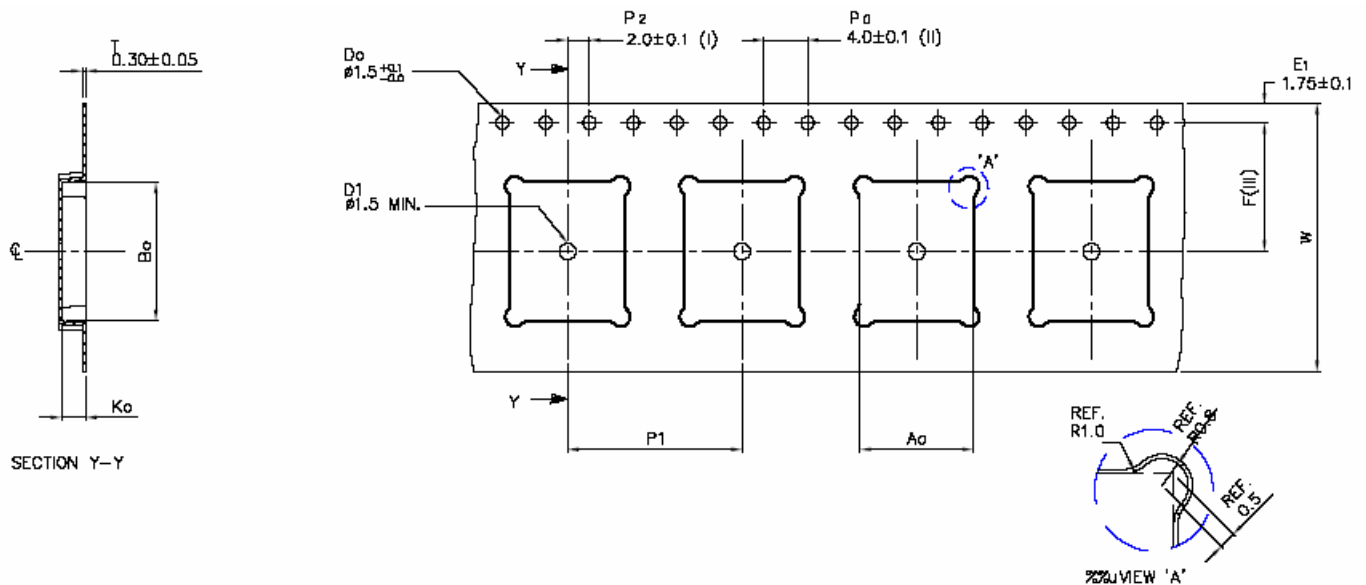

A <sub>0</sub>	10.40	+/- 0.1
B <sub>0</sub>	12.40	+/- 0.1
K <sub>0</sub>	2.20	+/- 0.1
F	11.50	+/- 0.1
P <sub>1</sub>	16.00	+/- 0.1
W	24.00	+/- 0.3

- (I) Measured from centreline of sprocket hole to centreline of pocket.  
 (II) Cumulative tolerance of 10 sprocket holes is  $\pm 0.2D$ .  
 (III) Measured from centreline of sprocket hole to centreline of pocket.  
 (IV) Other material available.  
 (V) Typical SR of form tape from  $10^5$  to  $10^{11}$  OHM/SQ  
 ALL DIMENSIONS IN MILLIMETRES UNLESS OTHERWISE STATED.

## Additional Products

Part Number	Description
EP5352QI	500mA DCDC with integrated inductor; 5mm x 4mm x 1.1mm package
EP5362QI	600mA DCDC with integrated inductor; 5mm x 4mm x 1.1mm package
EP5382QI	800mA DCDC with integrated inductor; 5mm x 4mm x 1.1mm package
EQ5352DI	500mA DCDC regulator; tiny 3mm x 2mm x 0.9mm DFN package
EQ5362DI	600mA DCDC regulator; tiny 3mm x 2mm x 0.9mm DFN package
EQ5382DI	800mA DCDC regulator; tiny 3mm x 2mm x 0.9mm DFN package
EN5312QI	1A DCDC with integrated inductor; 5mm x 4mm x 1.1mm package
EN5335QI	3A DCDC with integrated inductor; 10mm x 7.5mm x 1.85mm QFN package 3-Pin VID $V_{OUT}$ programming
EN5336QI	3A DCDC with integrated inductor; 10mm x 7.5mm x 1.85mm QFN package External resistor divider $V_{OUT}$ programming
EN5366QI	6A DCDC with integrated inductor; 12mm x 10mm x 1.85mm QFN package External resistor divider $V_{OUT}$ programming; Parallel Capable



## Contact Information

Enpirion, Inc.  
685 Route 202/206  
Suite 305  
Bridgewater, NJ 08807  
Phone: 908-575-7550  
Fax: 908-575-0775

*Enpirion reserves the right to make changes in circuit design and/or specifications at any time without notice. Information furnished by Enpirion is believed to be accurate and reliable. Enpirion assumes no responsibility for its use or for infringement of patents or other third party rights, which may result from its use. Enpirion products are not authorized for use in nuclear control systems, as critical components in life support systems or equipment used in hazardous environment without the express written authority from Enpirion.*